

Connector-Terminal Block Conversion Units for General-purpose Devices

XW2R

CSM_XW2R_DS_E_2_2

Many Variations in Connectors and Number of Poles

- Models available with Phillips screw, slotted screw, push-in, or e-CON connections.
- The terminal arrangement enables smoother wiring work.
- Push-in terminals simplify wiring and make the Terminal Blocks even easier to use. (In comparison to the OMRON XW2F.)
- Mounting to DIN Track is possible.

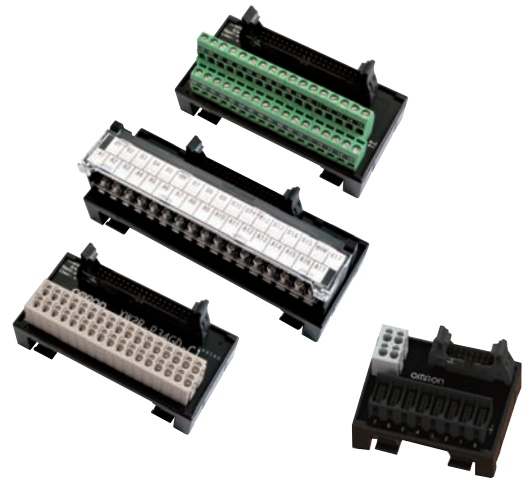

Model List

With power supply terminals

XW2R - □ □ □ G □ - COM

Wiring method		I/O Points	Mounted Connector type		Mounting method		Power supply terminals	
N	e-CON	08	G	MIL (XG4A)	D	DIN Track mounting	COM	Provided
					V	Vertical screw mounting		
					Blank	Horizontal screw mounting		

Without power supply terminals

XW2R - □ □ □ □ □ □ - T

Wiring method		Number of poles	Mounted Connector type		Plug/Socket		Mounting method	
J	Phillips screw	20	G	MIL (XG4A)	Blank	Plug (male)	D	DIN Track mounting
E	Slotted screw (rise up)	34	F	FCN	R	Socket (female) *	V	Vertical screw mounting
P	Push-in spring	40	D	D-sub *			Blank	Horizontal screw mounting
		50	R	MR *				
		60	M	MDR *				

* Consult your OMRON representative for these models.

Options (Order Separately)

Models that are mounted with screws are also available.

Refer to the XW2R-series Connector-Terminal Block Conversion Units Catalog (Cat. No. G077) for details.

Connecting Cables for Connector-Terminal Block Conversion Units

Refer to the XW2Z datasheet.

With power supply terminals

e-CON Type

Ordering Information

Appearance	I/O Points	I/O	Model *	Mounted Connector model	Cable Connector model
	8 Points	Input	XW2R-N08GD-COM	XG4A-1431 (MIL Connector) XN2D-4471 (e-CON Connector)	XG4M-1430-T (MIL Connector) XN2A-1470 (e-CON Connector)

* Only DIN Track mounting models are described here. Refer to the XW2R-series Connector-Terminal Block Conversion Units Catalog (Cat. No. G077) for information on screw mounting models.

Ratings and Specifications

Rated current	Power supply terminal block: 2 A, Connectors/e-CON Connectors: 1 A (However, rated current of e-CON Connector depends on the wires that are used.)
Rated voltage	24VDC
Insulation resistance	100M Ω min. (at 500VDC)
Dielectric strength	500VAC for 1 min (leakage current: 1 mA max.)
Ambient operating temperature	0 to 55°C
Applicable wires	Applicable wire sizes*
	Stripped length

AWG 24 to 14 (ferrules),
AWG 28 to 14 (stranded wires),
AWG 28 to 16 (solid wires)
(Outer diameter of insulation must be 4 mm max)

AWG28-16: 8 to 10 mm
AWG14: 9 to 10 mm

* This is the applicable range for the power supply terminal block. For the applicable wire sizes for I/O Connectors (e-CON), refer to page 3.

Wiring Diagram

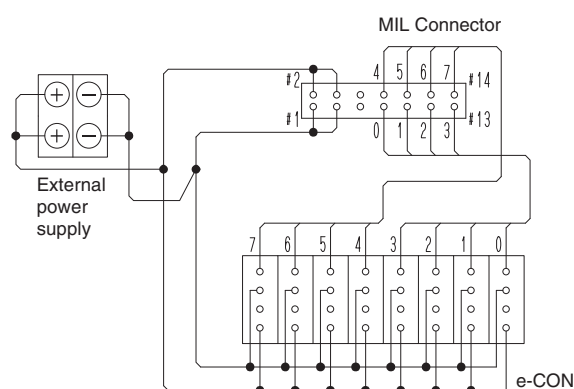

Dimensions

(Unit: mm)

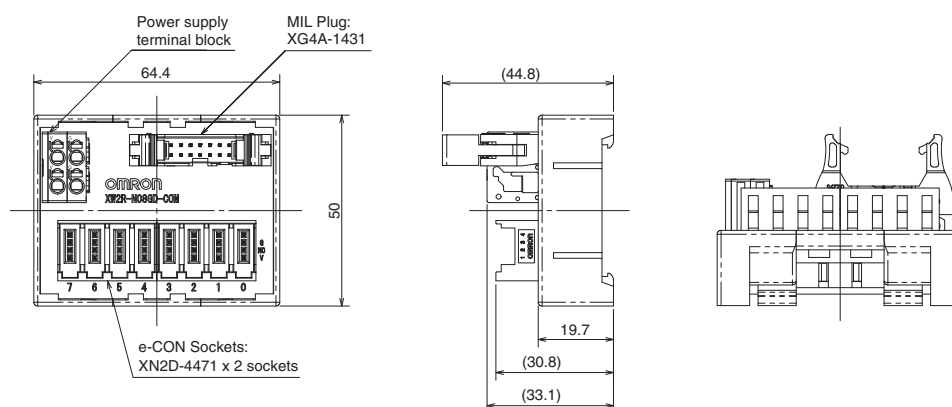

Input Device Connectors: XN2 e-CON Connectors

Ordering Information

For Sensor

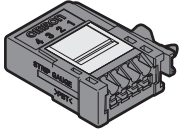
Appearance	Number of poles	Model
	4	XN2A-1470

Relay Connector

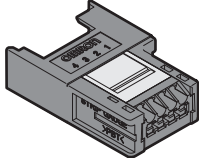
Appearance	Number of poles	Model
	4	XN2B-1470

Ratings and Specifications

Rated current	3 A/pin (with AWG20 wires), 2 A/pin (with AWG22 wires), 1 A/pin (with AWG24 wires), 0.5 A/pin (with AWG26 or AWG28 wires)
Rated voltage	32 VDC
Contact resistance	30 mΩ max. (at 20 mV, 100 mA max.)
Insulation resistance	10 ³ MΩ min. (at 500VDC)
Dielectric strength	1,000 VAC for 60 sec (leakage current: 1 mA max.)
Insertion durability	50 times
Ambient operating temperature	-30 to 75°C *
Applicable wires	Stranded wire 0.08mm ² (AWG28) to 0.5mm ² (AWG20) (Outer diameter of insulation must be 1.5 mm max)

* The operating temperature range is restricted by the maximum operating temperature of the cable.

Wiring Procedure

Wire Preparation

Use the strip gauge on the front panel and strip 7 to 8 mm of the insulation. If you use stranded wires, twist them several times.

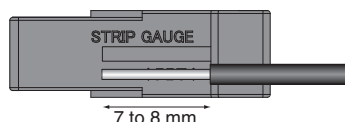

Connection Procedure

1. Press a flat-blade screwdriver into the operation hole until the operation lever locks into place.

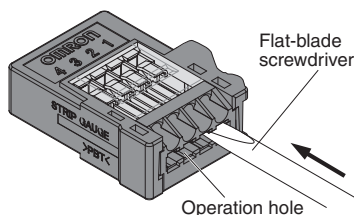

2. Insert the wire all the way into the wire insertion hole. Confirm that the insulation on the wire also enters the wire insertion hole and that the end of the wire has passed through the connection section.

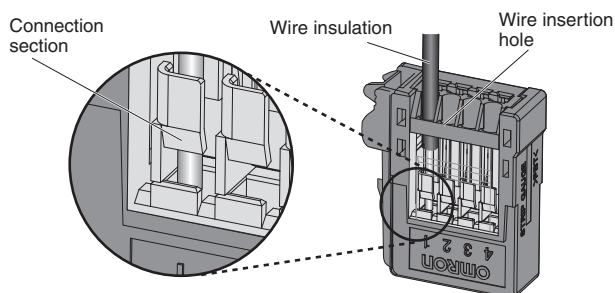

3. Insert a flat-blade screwdriver into the release hole and gently reset the lever. You should hear the operation lever reset.

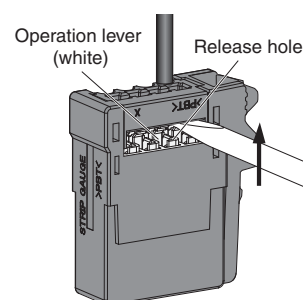

4. Finally, check the following items.

- Make sure the operation lever has been reset.
- Check the items given in step 2 again. (Pull lightly on the wire to see if it is held firmly in place.)

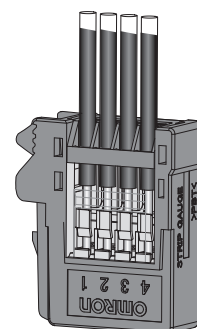

Disconnection Procedure

1. Press in the operation level, confirm that the operation lever is locked into place, and then pull out the wire.

2. After you remove the wire, always reset the operation lever. However, if you are going to connect another wire to the same terminal, you do not need to reset the operation lever and can immediately connect the other wire.

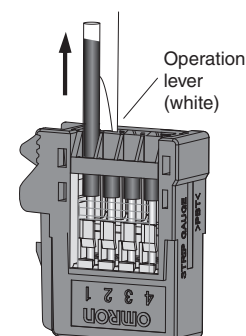

Without power supply terminals

Phillips screw

Ordering Information

Appearance *1	Mounted Connector model	Number of poles	Model *2	Dimension A (mm)	
	MIL Connector	XG4A-2031	20	XW2R-J20GD-T	81.7
		XG4A-3431	34	XW2R-J34GD-T	130.7
		XG4A-4031	40	XW2R-J40GD-T	151.7
		XG4A-5031	50	XW2R-J50GD-T	186.7
		XG4A-6031	60	XW2R-J60GD-T	221.7
	FCN Connector	FCN-364P040-AU	40	XW2R-J40FD-T	151.7

*1 The mounted Connector shown in the appearance illustration is a MIL Connector.

*2 Only DIN Track mounting models are described here. Refer to the XW2R-series Connector-Terminal Block Conversion Units Catalog (Cat. No. G077) for information on screw mounting models.

Ratings and Specifications

Rated current	1 A
Rated voltage	125 VAC, 24 VDC
Insulation resistance	100MΩ min. (at 500VDC)
Dielectric strength	500VAC for 1 min (leakage current: 1 mA max.)
Ambient operating temperature	0 to 55°C
Applicable wires	Applicable wire sizes
	AWG 22 to 16 (round or forked crimp terminals) AWG 26 to 16 (stranded or solid wires)
	Stripped length
	9 mm
	Tightening
	0.5 N·m

Details on Crimp Terminals

Wiring Terminal Blocks

- Using Crimp Terminals (With a Terminal Block with M3 Screws)

Terminal Screw Tightening Torque

- Use a tightening torque of 0.5 N·m when connecting wires or crimp terminals to the terminal block.

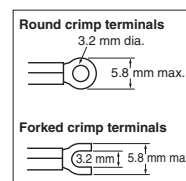

Applicable crimp terminals	Applicable wires
Round crimp terminals	1.25-3 AWG 22 to 16 (0.30 to 1.25 mm ²)
Forked crimp terminals	1.25Y-3 AWG 22 to 16 (0.30 to 1.25 mm ²)

Dimensions

(Unit: mm)

Wiring Diagram

Mounted Connector model: MIL Connector

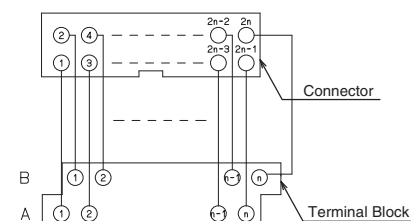

Mounted Connector model: FCN Connector

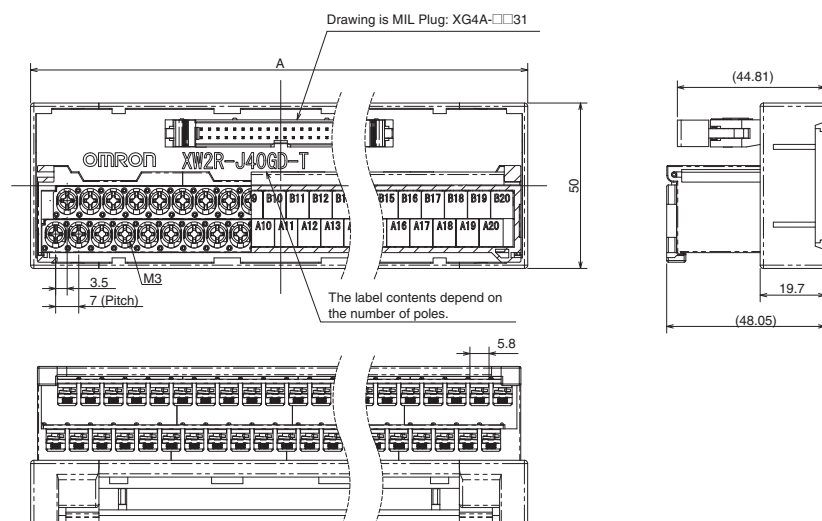
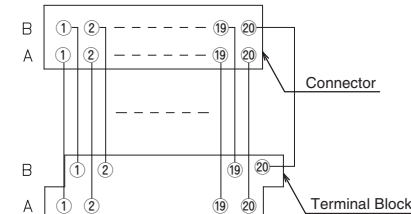

Label Contents

B1	B2	B3	B4	B5	B6	B7	B8	B9	B10	B11	B12	B13	B14	B15	B16	B17
A1	A2	A3	A4	A5	A6	A7	A8	A9	A10	A11	A12	A13	A14	A15	A16	A17

Note: The label contents for a Terminal Block with 34 poles are shown.

Without power supply terminals

Slotted screw (rise up)

Ordering Information

Appearance *1	Mounted Connector model	Number of poles	Model *2	Dimension A (mm)
	MIL Connector	XG4A-2031	XW2R-E20GD-T	64.4
		XG4A-3431	XW2R-E34GD-T	98.5
		XG4A-4031	XW2R-E40GD-T	113.5
		XG4A-5031	XW2R-E50GD-T	138.5
		XG4A-6031	XW2R-E60GD-T	163.5
	FCN Connector	FCN-364P040-AU	40	XW2R-E40FD-T

*1 The mounted Connector shown in the appearance illustration is a MIL Connector.

*2 Only DIN Track mounting models are described here. Refer to the XW2R-series Connector-Terminal Block Conversion Units Catalog (Cat. No. G077) for information on screw mounting models.

Ratings and Specifications

Rated current	1 A	
Rated voltage	125 VAC, 24 VDC	
Insulation resistance	100MΩ min. (at 500VDC)	
Dielectric strength	500VAC for 1 min (leakage current: 1 mA max.)	
Ambient operating temperature	0 to 55°C	
Applicable wires	Applicable wire sizes	AWG 22 to 16 (ferrules) AWG 26 to 16 (stranded or solid wires)
	Stripped length	7 mm
	Tightening	0.5 to 0.6 N·m

Details on Crimp Terminals

Applicable crimp terminals		Applicable wires
Rod	TC-05 Dia. = 1	AWG22 to AWG18 (0.30 to 0.75 mm ²)
	TC-1.25S Dia. = 1.5	AWG22 to AWG16 (0.30 to 1.25 mm ²)
Blade	BT1.25-9-1 BT1.25-10-1 W = 2.2	AWG22 to AWG16 (0.30 to 1.25 mm ²)

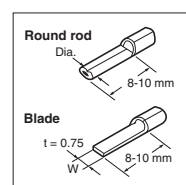

Note: Round rod and blade crimp terminals are made by Nichifu.

Dimensions

(Unit: mm)

Wiring Diagram

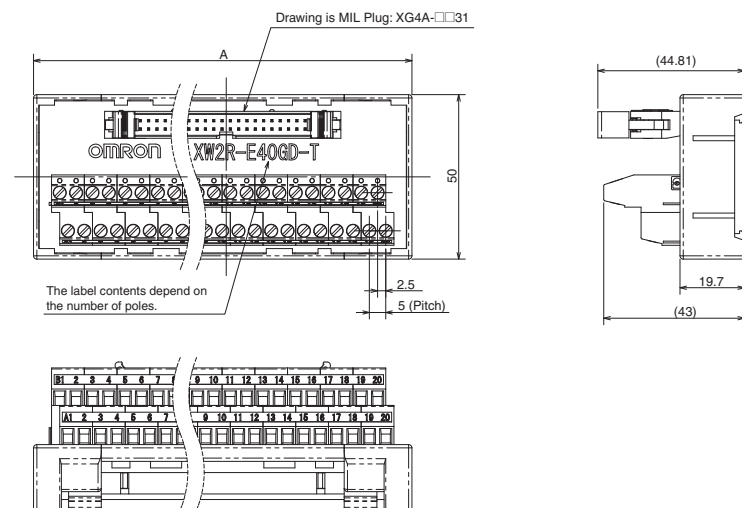

Mounted Connector model : MIL Connector

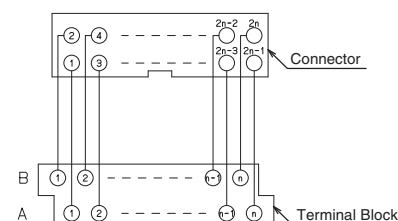

Mounted Connector model : FCN Connector

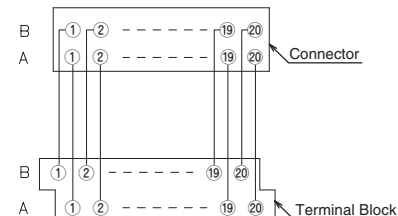

Label Contents

B	1	2	3	4	5	6	7	8	9	10	11	12	13	14	15	16	17		
A	1	2	3	4	5	6	7	8	9	10	11	12	13	14	15	16	17		

Note: The label contents for a Terminal Block with 34 poles are shown.

Without power supply terminals

Push-in spring

Ordering Information

Appearance *1	Mounted Connector model	Number of poles	Model *2	Dimension A (mm)
	MIL Connector	XG4A-2031	XW2R-P20GD-T	64.4
		XG4A-3431	XW2R-P34GD-T	98.5
		XG4A-4031	XW2R-P40GD-T	113.5
		XG4A-5031	XW2R-P50GD-T	138.5
		XG4A-6031	XW2R-P60GD-T	163.5
	FCN Connector	FCN-364P040-AU	40	XW2R-P40FD-T

*1 The mounted Connector shown in the appearance illustration is a MIL Connector.

*2 Only DIN Track mounting models are described here. Refer to the XW2R-series Connector-Terminal Block Conversion Units Catalog (Cat. No. G077) for information on screw mounting models.

Ratings and Specifications

Rated current	1 A
Rated voltage	125 VAC, 24 VDC
Insulation resistance	100MΩ min. (at 500VDC)
Dielectric strength	500VAC for 1 min (leakage current: 1 mA max.)
Ambient operating temperature	0 to 55°C
Applicable wires	Applicable wire sizes
	Stripped length

AWG 24 to 14 (ferrules)
AWG 28 to 14 (stranded or solid)
(Outer diameter of insulation must be 4 mm max.)

AWG28-16: 8 to 10 mm
AWG14: 9 to 10 mm

Details on Crimp Terminals

Applicable Ferrules

- Use ferrules of the lengths and thicknesses specified below. If other lengths or thicknesses are used, connection may not be possible or it may not be possible to insert or remove the posts.

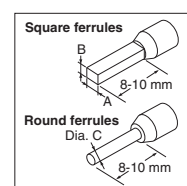

- Ferrule Dimensions

Square ferrules	Dimension A (Width)	2.7 mm max.	The cross-sectional area after crimping must be 4.8 mm ² or less
	Dimension B (Height)	2 mm max.	
Round ferrules	Dimension C (Diameter)	2 mm dia. max. (after crimping)	

Refer to page 7 for information on Square/Round ferrule and use tool.

Dimensions

(Unit: mm)

Wiring Diagram

Mounted Connector model: MIL Connector

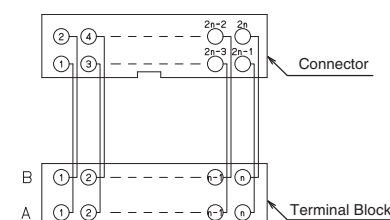

Mounted Connector model: FCN Connector

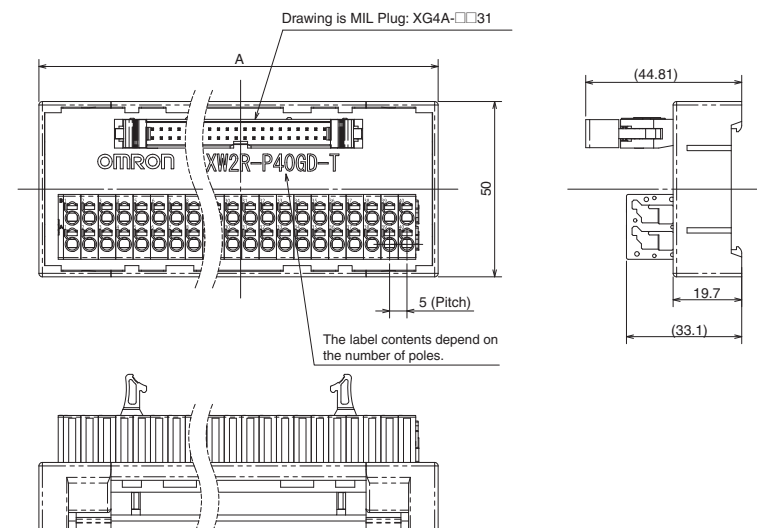
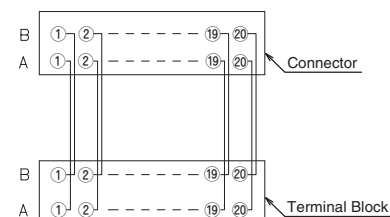

Label Contents

B	1	2	3	4	5	6	7	8	9	10	11	12	13	14	15	16	17
A	1	2	3	4	5	6	7	8	9	10	11	12	13	14	15	16	17

Note: The label contents for a Terminal Block with 34 poles are shown.

Safety Precautions

Precautions for Correct Use

Wiring Precautions

- Do not perform wiring work, remove connectors, or connect connectors while power is being supplied. Electric shock or damage to the device may result.
- Double-check all wiring before turning ON the power supply.
- After wiring, route the cable so that force is not applied directly to the connections.

Wires for Terminal Blocks

- Do not damage the cores when stripping the insulation from them.
- Always twist stranded wires together before connecting them.
- Do not presolder wires. It may not be possible to connect them or remove them.

XW2R-P□□ type (Square/Round ferrule)

Type of terminal	Manufacturer	Size	Recommend ferrule	Recommend crimp tool
Square ferrule	Phoenix Contact	AWG24	AI0.25-8□□	CRIMFOX6
		AWG22	AI0.34-8TQ	
		AWG20	AI0.5-10WH AI0.5-8WH	
		AWG18	AI0.75-10GY AI0.75-8GY	
		AWG16	AI1.5-10BK	
		AWG14	AI2.5-8BU	
	Weidmuller	AWG24	H0.25/12	PZ6 roto
		AWG22	H0.34/12	
		AWG20	H0.5/14	
		AWG18	H0.75/14	
		AWG16	H1.5/14	
		AWG14	H2.5/15D	
Round ferrule	Nichifu	AWG22- AWG16	TGV TC-1.25-9T	NH11 NH32 NH65

Note: □□ of ferrule model is for color (Ex: YE = Yellow)

When an electric wire is connected directly (J,E,P type)



Model	Strip length "a"
XW2R-J□□	9 mm
XW2R-E□□	7 mm
XW2R-P□□	AWG28-16: 8 to 10 mm
	AWG14: 9 to 10 mm

Mounting Units to and Removing Units from DIN Track

Mounting Procedure

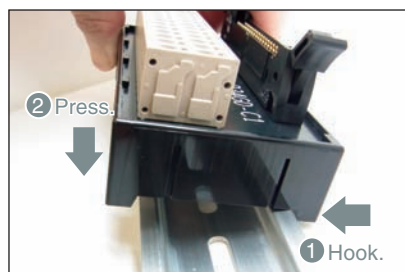

- Hook the Unit on the DIN Track.
- Press the Unit onto the DIN Track to secure it.

Removal Procedure

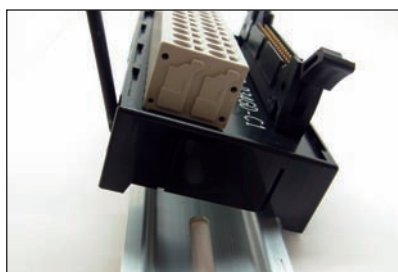

- Insert a flat-blade screwdriver into the DIN Track lock.
- Move the screwdriver like a lever to free the lock.

Connecting Spring cramp Terminals

Using Ferrules

How to insert wire

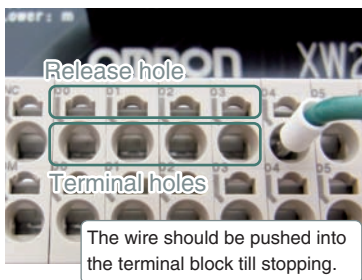

How to release wire



Using Stripped Wires

Inserting and Removing Wires

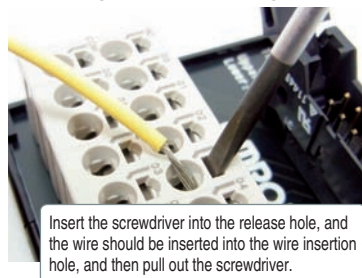

Inserting Wires

1. Press the a flat-blade screwdriver diagonally into the release hole. Press at an angle of 10° to 15°. If you press in the screwdriver correctly, you will feel the spring in the release hole.

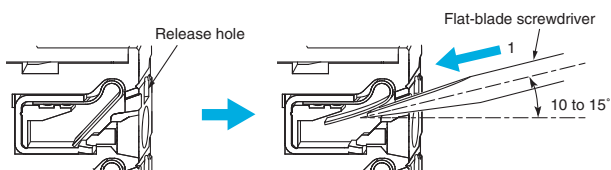

2. Leave the flat-blade screwdriver pressed into the release hole and insert the stranded wire or the solid wire into the terminal hole. Insert the stranded wire or the solid wire until the stripped portion is no longer visible to prevent shorting.

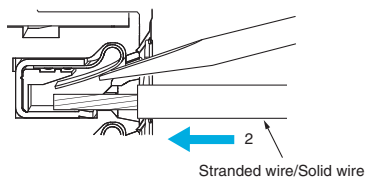

3. Remove the flat-blade screwdriver from the release hole.

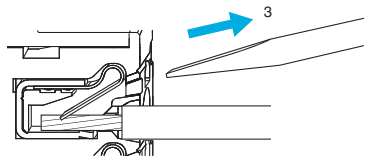

Removing Wires

1. Press the flat-blade screwdriver diagonally into the release hole. Press at an angle of 10° to 15°. If you press in the screwdriver correctly, you will feel the spring in the release hole.

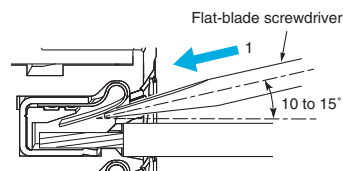

2. Leave the flat-blade screwdriver pressed into the release hole and pull out the wire.

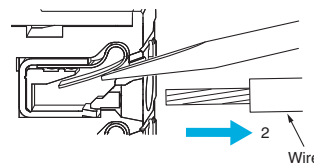

3. Remove the flat-blade screwdriver from the release hole.

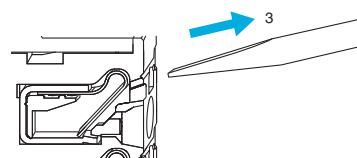

Precautions for Safe Use

- Do not press the flat-blade screwdriver straight into the release hole. Doing so may break the terminal block.

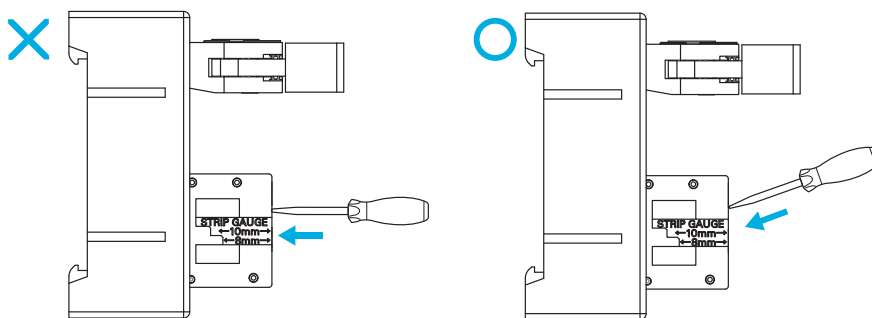

- When you insert a flat-blade screwdriver into a release hole, press it down with a force of 30 N max. Applying excessive force may damage the terminal block.
- Do not tilt or twist the flat-blade screwdriver while it is pressed into the release hole. Doing so may break the terminal block.

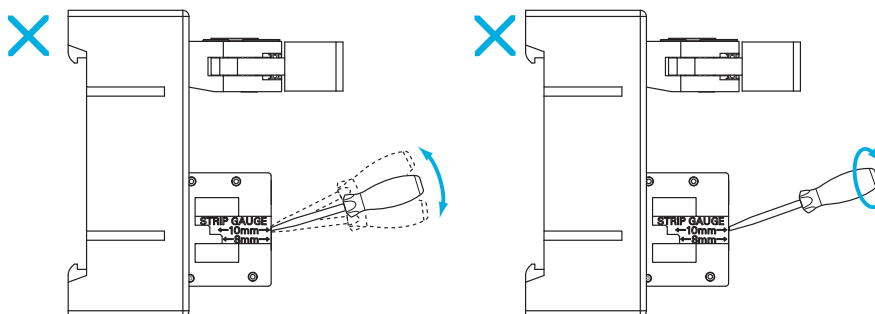

- Make sure that all wiring is correct.
- Do not bend the cable forcibly. Doing so may sever the cable.

Use tool

- Select a use tool from following table.

Model	Use tool	Specialized tool and dimension
XW2R-J□□	Phillips screwdriver	JIS#2
XW2R-E□□	Flat-blade screwdriver	Model XW4Z-00B Head of screwdriver is 0.4 x 2.5mm max.
XW2R-P□□		

Flat-blade screwdriver

Model
XW4Z-00B

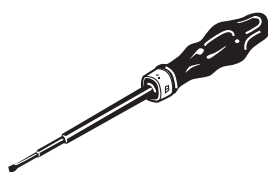

Bending Radius of Connecting Cables

- To prevent damaging the Connecting Cables, use the following minimum bending radii as guidelines.

XW2Z - □ □ □ □ □

End of model number	Minimum bending radius
BF-L, EE-L, FF-L	66 mm
A	67.2 mm
EE	83 mm
B, D, K, L, N	88 mm

For checking electrical continuity

- XW2R-E□□ type: There is no electrical continuity in the screw, Please confirm it at hole for confirming continuity or wiring part.

Terms and Conditions Agreement

Read and understand this catalog.

Please read and understand this catalog before purchasing the products. Please consult your OMRON representative if you have any questions or comments.

Warranties.

(a) Exclusive Warranty. Omron's exclusive warranty is that the Products will be free from defects in materials and workmanship for a period of twelve months from the date of sale by Omron (or such other period expressed in writing by Omron). Omron disclaims all other warranties, express or implied.

(b) Limitations. OMRON MAKES NO WARRANTY OR REPRESENTATION, EXPRESS OR IMPLIED, ABOUT NON-INFRINGEMENT, MERCHANTABILITY OR FITNESS FOR A PARTICULAR PURPOSE OF THE PRODUCTS. BUYER ACKNOWLEDGES THAT IT ALONE HAS DETERMINED THAT THE PRODUCTS WILL SUITABLY MEET THE REQUIREMENTS OF THEIR INTENDED USE.

Omron further disclaims all warranties and responsibility of any type for claims or expenses based on infringement by the Products or otherwise of any intellectual property right. (c) Buyer Remedy. Omron's sole obligation hereunder shall be, at Omron's election, to (i) replace (in the form originally shipped with Buyer responsible for labor charges for removal or replacement thereof) the non-complying Product, (ii) repair the non-complying Product, or (iii) repay or credit Buyer an amount equal to the purchase price of the non-complying Product; provided that in no event shall Omron be responsible for warranty, repair, indemnity or any other claims or expenses regarding the Products unless Omron's analysis confirms that the Products were properly handled, stored, installed and maintained and not subject to contamination, abuse, misuse or inappropriate modification. Return of any Products by Buyer must be approved in writing by Omron before shipment. Omron Companies shall not be liable for the suitability or unsuitability or the results from the use of Products in combination with any electrical or electronic components, circuits, system assemblies or any other materials or substances or environments. Any advice, recommendations or information given orally or in writing, are not to be construed as an amendment or addition to the above warranty.

See <http://www.omron.com/global/> or contact your Omron representative for published information.

Limitation on Liability; Etc.

OMRON COMPANIES SHALL NOT BE LIABLE FOR SPECIAL, INDIRECT, INCIDENTAL, OR CONSEQUENTIAL DAMAGES, LOSS OF PROFITS OR PRODUCTION OR COMMERCIAL LOSS IN ANY WAY CONNECTED WITH THE PRODUCTS, WHETHER SUCH CLAIM IS BASED IN CONTRACT, WARRANTY, NEGLIGENCE OR STRICT LIABILITY.

Further, in no event shall liability of Omron Companies exceed the individual price of the Product on which liability is asserted.

Suitability of Use.

Omron Companies shall not be responsible for conformity with any standards, codes or regulations which apply to the combination of the Product in the Buyer's application or use of the Product. At Buyer's request, Omron will provide applicable third party certification documents identifying ratings and limitations of use which apply to the Product. This information by itself is not sufficient for a complete determination of the suitability of the Product in combination with the end product, machine, system, or other application or use. Buyer shall be solely responsible for determining appropriateness of the particular Product with respect to Buyer's application, product or system. Buyer shall take application responsibility in all cases.

NEVER USE THE PRODUCT FOR AN APPLICATION INVOLVING SERIOUS RISK TO LIFE OR PROPERTY OR IN LARGE QUANTITIES WITHOUT ENSURING THAT THE SYSTEM AS A WHOLE HAS BEEN DESIGNED TO ADDRESS THE RISKS, AND THAT THE OMRON PRODUCT(S) IS PROPERLY RATED AND INSTALLED FOR THE INTENDED USE WITHIN THE OVERALL EQUIPMENT OR SYSTEM.

Programmable Products.

Omron Companies shall not be responsible for the user's programming of a programmable Product, or any consequence thereof.

Performance Data.

Data presented in Omron Company websites, catalogs and other materials is provided as a guide for the user in determining suitability and does not constitute a warranty. It may represent the result of Omron's test conditions, and the user must correlate it to actual application requirements. Actual performance is subject to the Omron's Warranty and Limitations of Liability.

Change in Specifications.

Product specifications and accessories may be changed at any time based on improvements and other reasons. It is our practice to change part numbers when published ratings or features are changed, or when significant construction changes are made. However, some specifications of the Product may be changed without any notice. When in doubt, special part numbers may be assigned to fix or establish key specifications for your application. Please consult with your Omron's representative at any time to confirm actual specifications of purchased Product.

Errors and Omissions.

Information presented by Omron Companies has been checked and is believed to be accurate; however, no responsibility is assumed for clerical, typographical or proofreading errors or omissions.

2017.4

In the interest of product improvement, specifications are subject to change without notice.

OMRON Corporation
Industrial Automation Company

<http://www.ia.omron.com/>

(c)Copyright OMRON Corporation 2017 All Right Reserved.