

Top 100
Global
Innovator
for 10 years

XGT Series

Programmable Logic Controller



XGT series, innovative solutions for system integration
from field to information level.
Open Network System Integration



neXt Generation Technology
XGT Series



FEATURES 4 ~ 13

FEATURES



CPU 14 ~ 31

CPU



SYSTEM 32 ~ 43

SYSTEM



NETWORK 44 ~ 89

NETWORK



SPECIAL 90 ~ 121

SPECIAL



SOFTWARE 122 ~ 143

SOFTWARE

Welcome to XGT World!

XGT series will meet your needs and expectations, enabling the highest possible productivity and performance levels and more.



XGK / CPUU CPUH CPUA
CPUV CPUE



XGR



XGK / CPUUN CPUHN CPUSN



Features

XGT series is the next-generation solution with a new concept providing advanced engineering environment based on open network, fastest processing speed, compact size and user-friendly software.



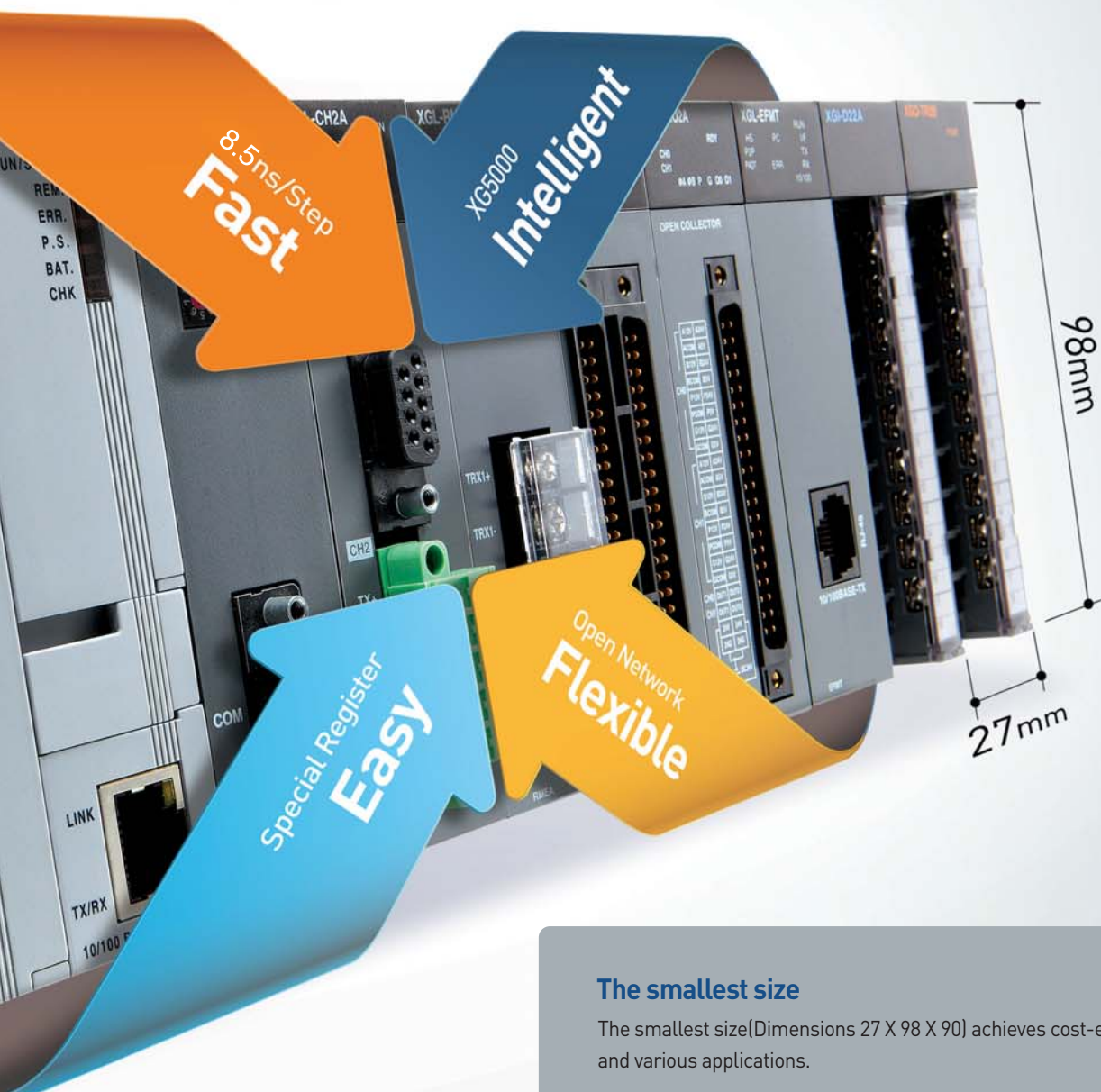

The smallest size

The smallest size(Dimensions 27 X 98 X 90) achieves cost-efficiency and various applications.

Item	Power Supply	CPU	8-slot Base
Size (WXHXD)	55X98X90	27X98X90	318X98X17

XGT series, neXt Generation Technology for easier, faster and smarter automation, will provide you with future-oriented solutions, bringing greener, safer and more convenient life for you...

System Integration of Open Network

XGT series support various communication solutions ranging from field control to information level with Fast Ethernet, Profibus-DP, DeviceNet, Modbus, etc.

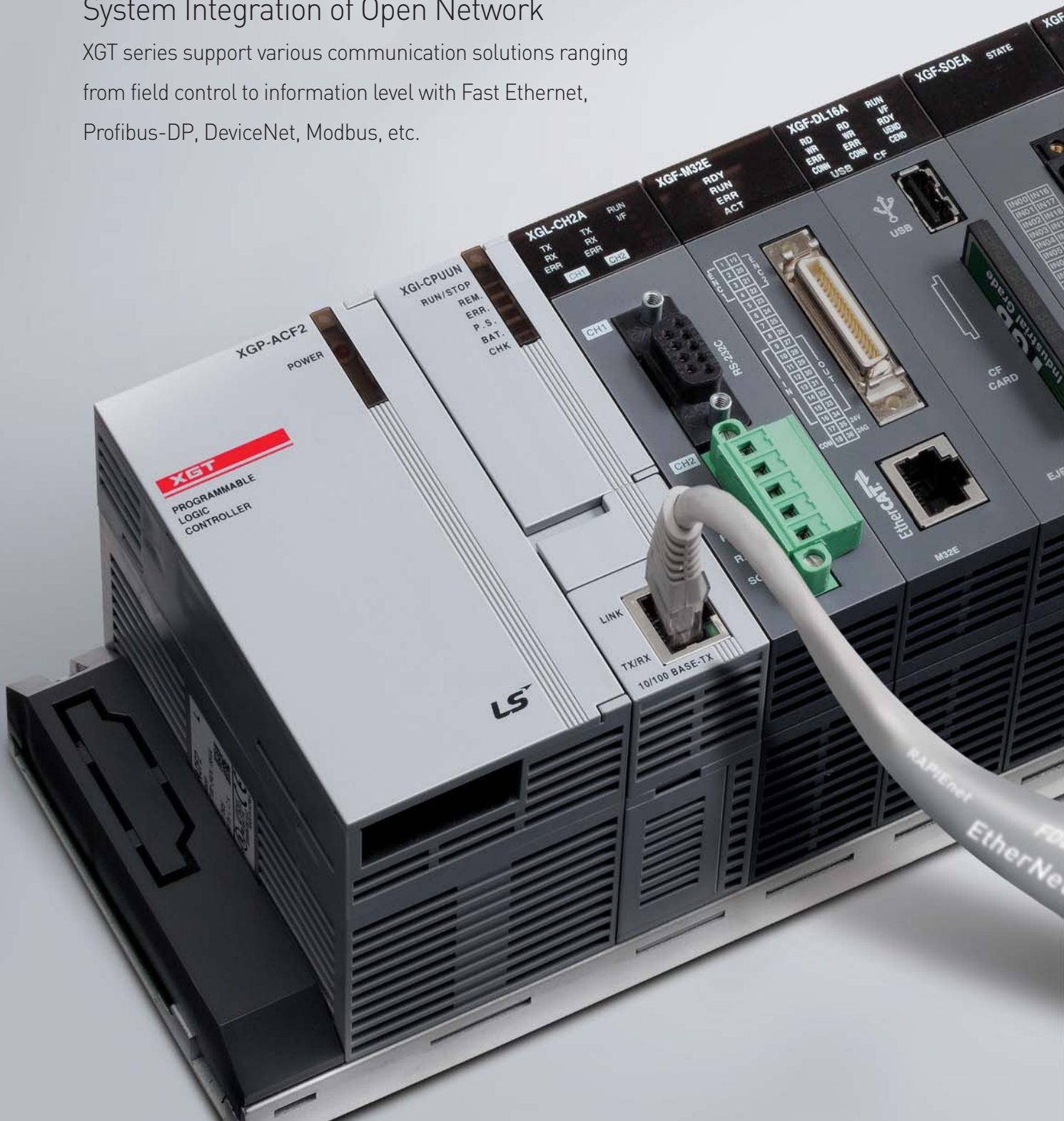

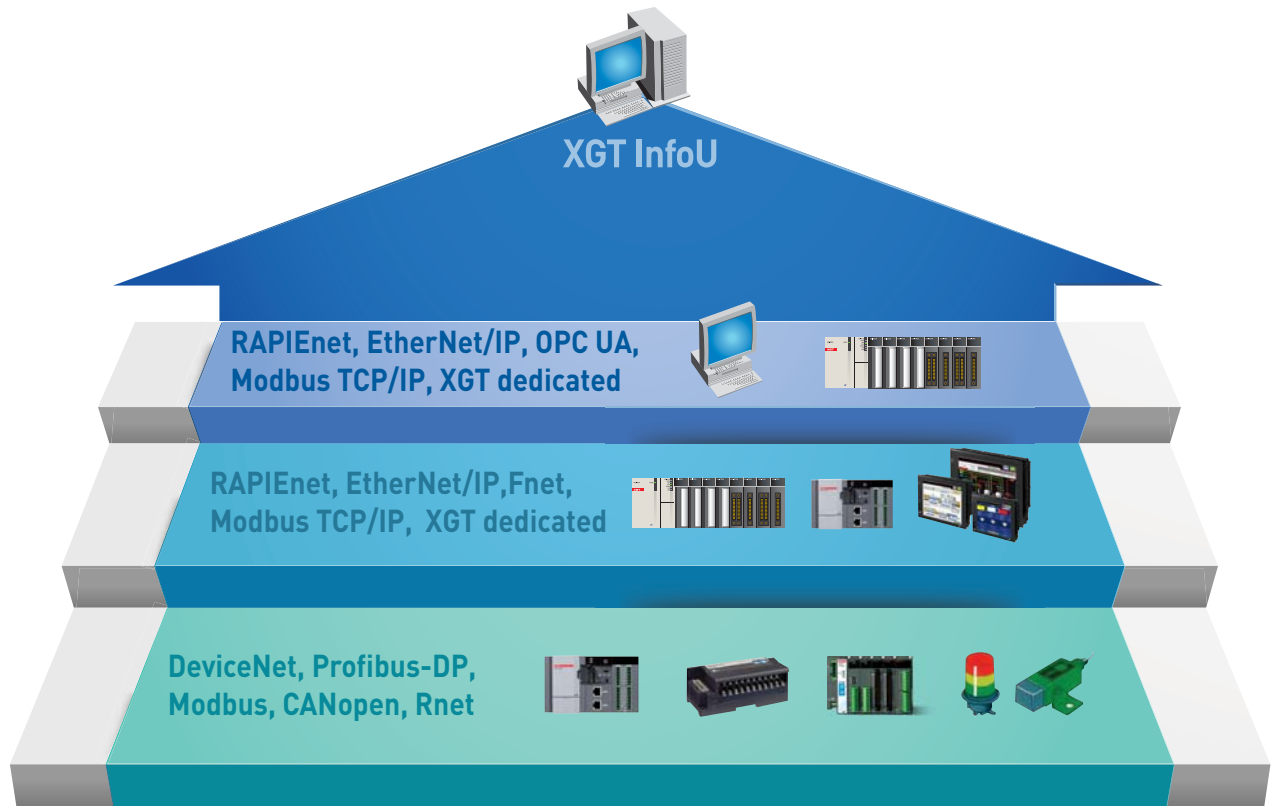

Item	Industrial Ethernet network				Fieldbus network				
	RAPIEnet	EtherNet/IP	ModbusTCP/IP	XGT dedicated	Cnet	Fnet	Profibus-DP	DeviceNet	Rnet
Master/Client module	XGL-EFMTB, XGL-EFMFB, XGL-EFMHB				XGL-C22B, XGL-C42B, XGL-CH2B	XGL-FMEA	XGL-PMEB	XGL-DMEB	XGL-RMEB
Slave/Server module	XGL-DBDT, XGL-DBDF, XGL-DBDH				-	-	XGL-PSRA, XGL-PSEA	-	-
Transmission speed	100/1000Mbps				300 ~ 115,200bps	1Mbps	Max.12Mbps	Max.500Kbps	1Mbps
Media	100m(Tp) 2Km (Fiber Optic)				Max.1.2km (422/485)	750m(Seg) Max.5.25km	Max.1.2km	Max.500m	750m (Seg) Max.5.25km
Distance (Node to node)									
Max. number of connection	64	64	64	64 16(Server)	32	64	32(Seg) 128	64	64
Protocol	RAPIEnet	EtherNet/IP	Modbus TCP/IP	XGT dedicated	Modbus RTU/ASCII	Fnet (LS dedicated)	Profibus-DP	DeviceNet	Rnet (LS dedicated)
Service	High-speed link	●	-	-	●	-	●	●	●
	P2P	●	●	-	●	●	-	-	-
	XG5000 Service	●	●	-	●	●	-	-	-
	E-Mail Service	-	-	-	●	-	-	-	-
Configuration Software	XG5000								
Max. number of installation	24ea(High-speed link : 12ea, P2P service : 8ea)								



Do you want more powerful features and performance? answer is LS ELECTRIC

XGT New CPU

New XGT CPU has 3 times faster cpu processing speed, 2 times larger memory capacity and built in ethernet port.

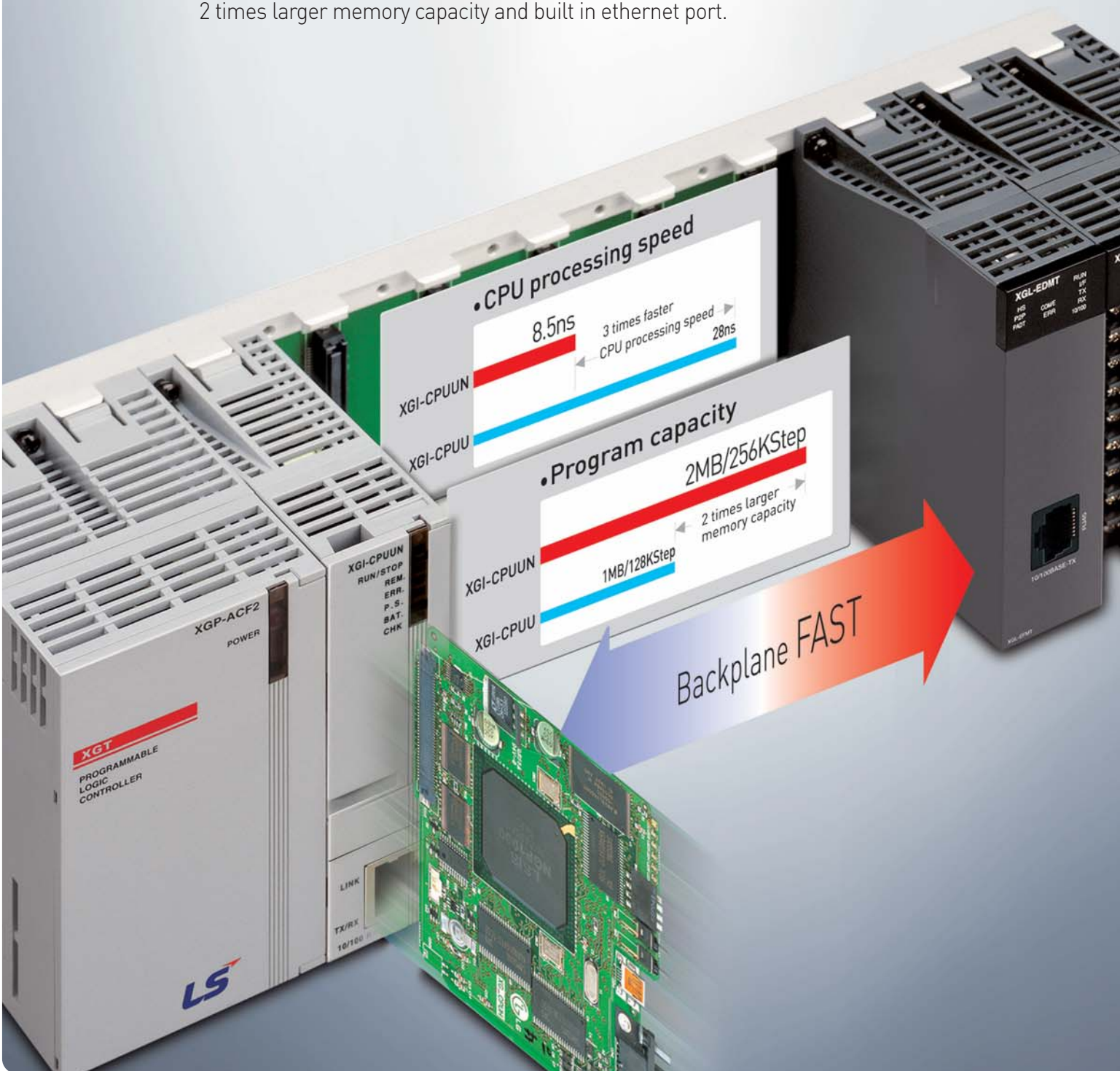

Compare of scan time between XGI-CPUU and XGI-CPUUN

Using 1 MOVE word

Item	XGI-CPUUN	XGI-CPUU/D	XGI-CPUU	XGI-CPUH	XGI-CPUS
Current scan time	0.2ms	0.6ms	0.9ms	1.0ms	0.8ms
Min. scan time	0.2ms	0.6ms	0.8ms	1.0ms	0.7ms
Max. scan time	0.4ms	0.9ms	1.5ms	1.8ms	1.7ms

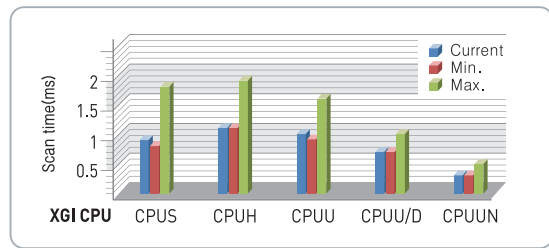

Using 1,000 MOVE word

Item	XGI-CPUUN	XGI-CPUU/D	XGI-CPUU	XGI-CPUH	XGI-CPUS
Current scan time	0.5ms	1.2ms	1.7ms	1.7ms	1.5ms
Min. scan time	0.5ms	1.2ms	1.6ms	1.6ms	1.5ms
Max. scan time	0.7ms	1.5ms	2.3ms	2.5ms	2.3ms

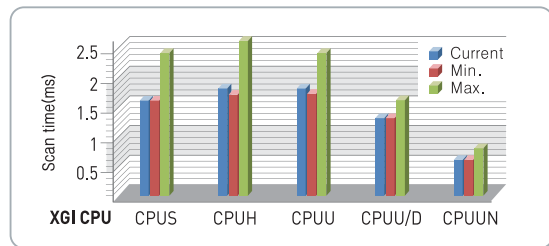

Device memory range

CPU	Device memory	XGI-CPUU	XGI-CPUUN
XGI CPU	A	512KB	1024KB
	M	256KB	512KB
XGK CPU	P/M/K	32,768 point	65,536 point
	T	T000 - T2047	T000 - T8191
	C/S/Z, R/ZR	2 ~ 8 times larger	

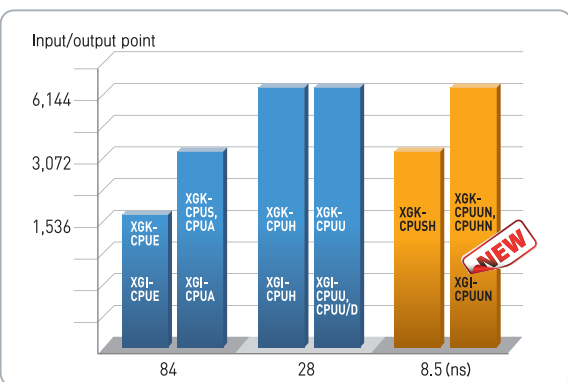

Easy connection

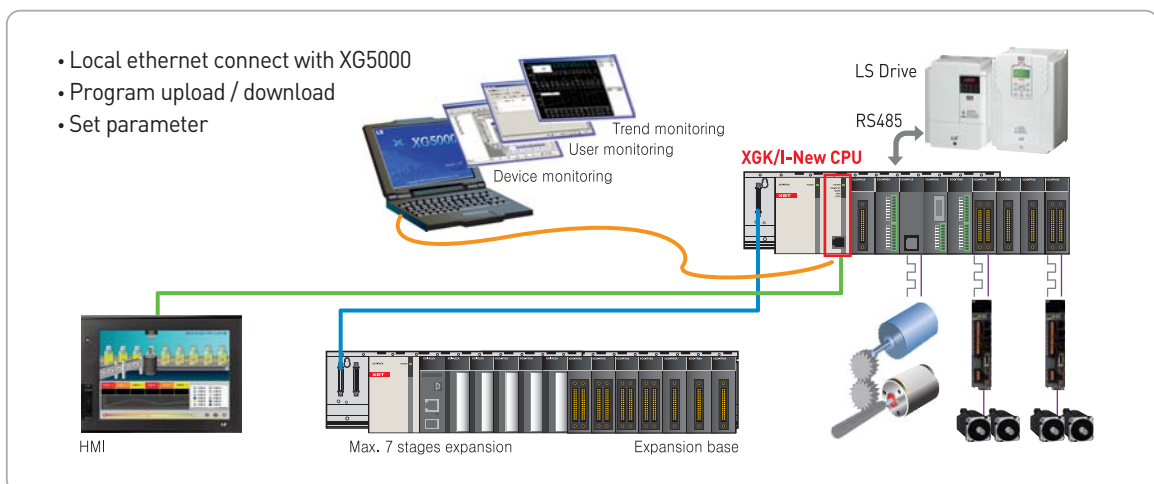

Engineering & Programming Innovation Easy

Special Register

XGT series expand device memory and support advanced programming environment with Index register (Z), File register (U), and Analog register (U).



File register

As a non-volatile memory type, data are secured even in times of blackout or CPU reset.



Analog register

Assigning base, slot and memory buffer of an analog module to device, A/D conversion data can be accessed without analog commands.



Index register

Index register is used in the sequence program for array operation.

Example of Analog Register

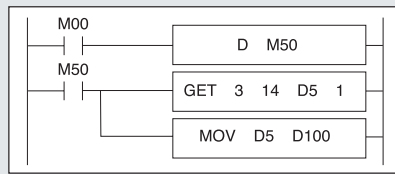

KGLWIN

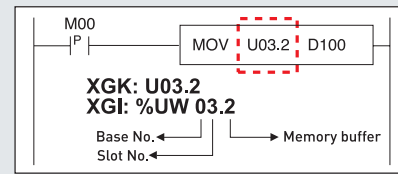

XG5000

Analog Operation without Programming

Special module setup and operation is achieved by just parameter setting without additional program.

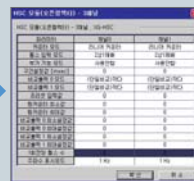
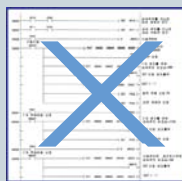

Set up high-speed

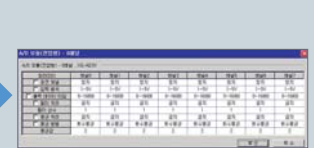
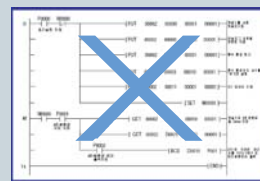

Set up analog module counter module

Program Modularization and Task Operation

Available to run multiful programs through medulization of scan programs based on functions and author, and to operate task programs triggered by specific conditions.

Program type	Description	Number
Scan program	Scan	Executed in every scan 256-task
Task program	Initialization task	Executed only one time when power turns on 1
	Time driven task	Executed with a constant time interval specified in parameter setting 32
	Internal task	Executed by internal condition 32
	External interrupt task	Executed by external interrupt input 32

IEC standard language (XGI): LD, SFC, ST

Ladder Diagram

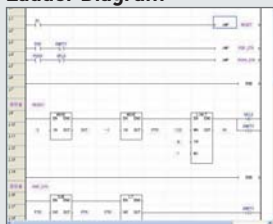

SFC

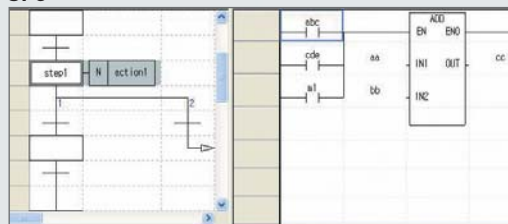

ST

```

19 X2 := (- B - SQRT(B*B))/(2.0*B) ;
20 END_IF ;
21
22
23 // CASE문 예제
24 TV := WORD_BCD_TO_INT(THUBWHEEL);
25 TV_ERROR := 0;
26 CASE TV OF
27   1,5: DISPLAY := QUEN_TEMP;
28   2: DISPLAY := MOTOR_SPEED;
29   3: DISPLAY := GROSS - TARE;
30   4, 6..10: DISPLAY := ADD(TV, 4);
31 ELSE DISPLAY := 0 ;
32   TV_ERROR := 1;
33 END_CASE;
34 HUBWHEEL := INT_TO_BCD_WORD(DISPLAY);
35
36 // FOR문 예제
37 SUM := 0;
38 FOR I := 1 TO 3 DO
39   FOR J := 1 TO 2 DO
40     IF FLAG THEN EXIT; END_IF;
41     SUM := SUM + J ;
42   END_FOR;
43   SUM := SUM + I ;
44 END_FOR;
    
```

ST features

- High-level Language
- Fit for the complicate algorithm
- Various open source (Compatibility)
- Easy data processing
- Convenient text editor

User defined Function block (XGI)

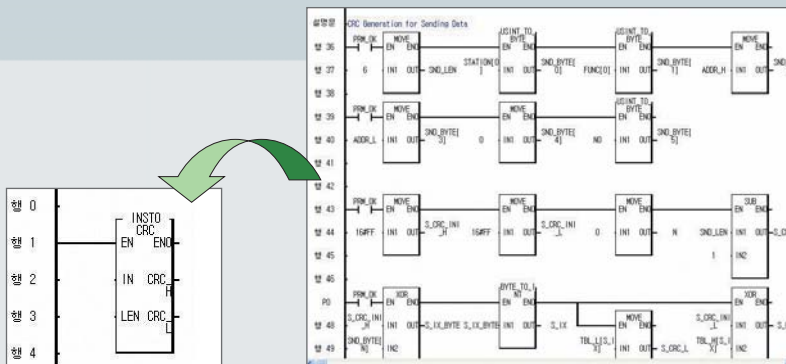

- Standardize the program using function or function block
- Register the standardized program as a library file and reuse the library for another project





CPU & System Configuration

XGT series contain variety of CPU types for customized solutions which support wide coverage from small / middle- to large size-system control.

Contents	16 CPU module
	24 I/O module



XGK CPU (LS Standard)

Premium CPU for high-speed and large scale application



XGK-CPUUN

- Program capacity: 256K steps
- I/O points: 6,144
- I/O device point: 65,536 (Remote I/O)
- Processing speed: 8.5ns/step



XGK-CPUHN

- Program capacity: 128K steps
- I/O points: 6,144
- I/O device point: 65,536 (Remote I/O)
- Processing speed: 8.5ns/step



XGK-CPUSN

- Program capacity: 64K steps
- I/O points: 3,072
- I/O device point: 65,536 (Remote I/O)
- Processing speed: 8.5ns/step



XGK-CPUU (Ultra capacity)

- Program capacity: 128K steps
- I/O points: 6,144
- I/O device point: 32,768 (Remote I/O)
- Processing speed: 28ns/step



XGK-CPUH (High performance)

- Program capacity: 64K steps
- I/O points: 6,144
- I/O device point: 32,768 (Remote I/O)
- Processing speed: 28ns/step



XGK-CPUA (Advanced)

- Program capacity: 32K steps
- I/O points: 3,072
- I/O device point: 32,768 (Remote I/O)
- Processing speed: 28ns/step

General sequence controller PLC CPU



XGK-CPUS (Standard)

- Program capacity: 32K steps
- I/O points: 3,072
- I/O device point: 32,768 (Remote I/O)
- Processing speed: 84ns/step



XGK-CPUE (Economic)

- Program capacity: 16K step
- I/O point: 1,536
- I/O device point: 32,768 (Remote I/O)
- Processing speed: 84ns/step

XGI CPU (IEC Standard)

Premium CPU for high-speed and large scale application



XGI-CPUUN

- Program capacity: 2MBytes
- I/O points: 6,144
- I/O device point: 131,072 (Remote I/O)
- Processing speed: 8.5ns/step



XGI-CPUU

- Program capacity: 1MBytes
- I/O points: 6,144
- I/O device point: 131,072 (Remote I/O)
- Processing speed: 28ns/step



XGI-CPUH

- Program capacity: 512KBytes
- I/O points: 6,144
- I/O device point: 131,072 (Remote I/O)
- Processing speed: 28ns/step

General sequence controller PLC CPU

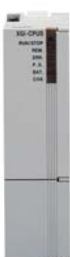

XGI-CPUS (IEC Standard)

- Program capacity: 128KBytes
- I/O points: 3,072
- I/O device point: 32,768 (Remote I/O)
- Processing speed: 28ns/step

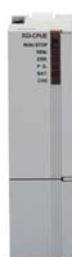

XGI-CPUE (IEC Standard)

- Program capacity: 64KBytes
- I/O points: 1,536
- I/O device point: 32,768 (Remote I/O)
- Processing speed: 84ns/step

CPU Module System composition

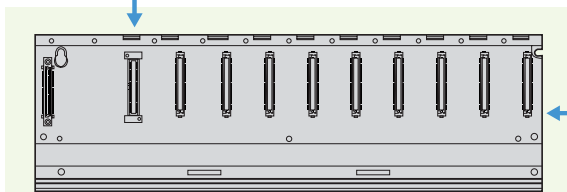
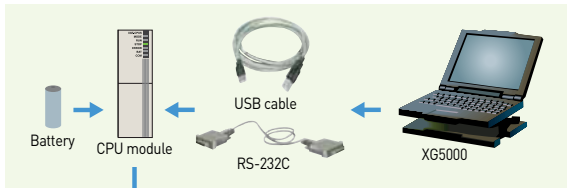

Item	Type	Description	
Expansion cable	XGC-E041	Expansion cable 0.4m	
	XGC-E061	Expansion cable 0.6m	
	XGC-E121	Expansion cable 1.2m	
	XGC-E301	Expansion cable 3.0m	
	XGC-E501	Expansion cable 5.0m	
	XGC-E102	Expansion cable 10m	
	XGC-E152	Expansion cable 15m	
	XGT-TERA	Expansion terminator	
	Expansion terminator		

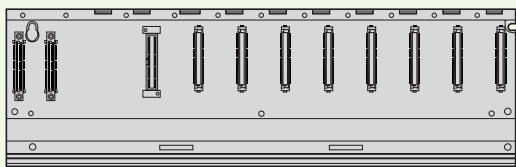

Item	Main base	Expansion base
4 slot	XGB-M04A	XGB-E04A
6 slot	XGB-M06A	XGB-E06A
8 slot	XGB-M08A	XGB-E08A
10 slot	XGB-M10A	-
12 slot	XGB-M12A	XGB-E12A

XG5000 Cable (RS-232C)

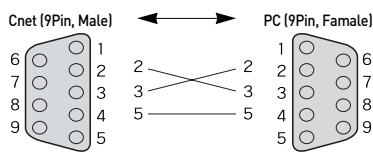

	CPU module	I/O point
XGK	XGK-CPUH, CPUU, CPUHN, CPUUN	6,144
	XGK-CPUS, CPUA, CPUSN	3,072
	XGK-CPUE	1,536
XGI	XGI-CPUUN, CPUU/D, CPUU, CPUH	6,144
	XGI-CPUS	3,072
	XGI-CPUE	1,536

CPU Connecting Cable	
USB 301A	USB downloading cable
K1C-050A	RS-232C downloading cable

Item	Type	Description
USB cable	USB-301A	USB downloading cable
RS-232C cable	K1C-050A	RS-232C downloading cable

Item	Input module		
	AC110V	AC220V	DC24V
8 points	-	XGI-A21A	XGI-D21A
16 points	XGI-A12A	-	XGI-D22A
32 points	-	-	XGI-D24A
	-	-	XGI-D24B
64 points	-	-	XGI-D28A
	-	-	XGI-D28B



Power module			
AC	Free Voltage	XGP-ACF1	DC5V 3A DC24V 0.6A
		XGP-ACF2	DC5V 6A
	220V	XGP-AC23	DC5V 8.5A
DC		XGP-DC42	DC5V 6A

Item	Output module		
	Relay	Triac	Transistor
8 points	XGQ-RY1A	-	XGQ-TR1C
16 points	XGQ-RY2A	XGQ-SS2A	XGQ-TR2A
	XGQ-RY2B	-	XGQ-TR2B
32 points	-	-	XGQ-TR4A
	-	-	XGQ-TR4B
64 points	-	-	XGQ-TR8A
	-	-	XGQ-TR8B

Special module		
Analog input	XGF-AV8A	Voltage input type, 8Ch
	XGF-AC8A	Current input type, 8Ch
	XGF-AD8A	Voltage/ Current input, 8Ch
	XGF-AD4S	Voltage/ Current input, 4Ch (Isolated)
	XGF-AD16A	Voltage/ Current input, 16Ch
Analog output	XGF-AW4S	2-wire, Voltage/ Current input, 4Ch (Isolated)
	XGF-DV4A	Voltage output type, 4Ch
	XGF-DC4A	Current output type, 4Ch
	XGF-DV8A	Voltage output type, 8Ch
	XGF-DC8A	Current output type, 8Ch
Analog Input/Output	XGF-DV4S	Voltage output, 4Ch (Isolated)
	XGF-DC4S	Current output, 4Ch (Isolated)
High-speed counter	XGF-AH6A	Input: 4ch, Voltage/ Current Output: 2Ch Voltage/ Current
	XGF-HO2A	Pulse (OC) input type, 2Ch
Positioning	XGF-HD2A	Pulse (LD) input type, 2Ch
	XGF-PD1H-P04H	Open collector, 1-4axes
Positioning (Network Type)	XGF-PD1H-PD4H	Line drive, 1-4axes
	XGF-PN8A	LS Standard EtherCAT Net. 8axes
Motion Module	XGF-PN8B	Standard EtherCAT Net. 8axes
	XGF-M32E	Standard EtherCAT Net. 8axes
Temperature control	XGF-TC4S	Thermocouple input, 4Ch
	XGF-RD4A	RTD input, 4Ch
	XGF-RD4S	RTD input, 4Ch (Insulated)
Temperature controller	XGF-TC4UD	Input: 4ch.(Voltage/Current, RTD/TC) Output: 8ch.(TR/Current) Controller: 4 loops
	XGF-TC4RT	Input: 4ch.(RTD) Output: 4ch.(TR) Controller: 4 loops
Event input	XGF-S0EA	DC24V, 32points
Data log	XGF-DL16A	USB2.0.CF2001,Max16Gbyte, 32 points 1 slot(Input 22 points, output 10 points)

Communication module		
RAPIEnet+ - RAPIEnet v2 - EtherNet/IP - Modbus TCP/IP - Dedicated XGT Network	XGL-EFMTB	Master/Client, Twisted fair 2ch.
	XGL-EFMFB	Master/Client, Fiber optic 2ch.
	XGL-EFMHB	Master/Client, Twisted fair/fiber optic
	XGL-DBDT	Expansion driver - Twisted pair 2ch.
	XGL-DBDF	Expansion driver - Fiber optic 2ch.
	XGL-DBDH	Expansion driver - Fiber optic / Twisted pair
	XGL-ES4T	Stand alone switch twisted pair 4ch.
	XGL-ES4H	Stand alone switch twisted 2ch. fiber 2ch.
	XGL-EH5T	Open Ethernet switching hub
	Computer Link (Cnet)	XGL-CH2B
XGL-C22B		RS-232C 2ch
XGL-C42B		RS-422/485 2ch
DeviceNet(Dnet)	XGL-DMEB	DeviceNet, Master
	XGL-DSEB	DeviceNet, Slave
Profibus-DP (Pnet)	XGL-PMEB	Profibus-DP, Master
	XGL-PSRA	Profibus-DP Slave, Remote interface
Rnet	XGL-PSEA	Profibus-DP Slave
	XGL-RMEB	Rnet, Master, TP
Fnet	GOL-RR8T	Rnet stand alone repeater hub
	XGL-FMEA	Fnet, Master
BACnet/IP	XGL-BIPT	BACnet client/server
	XGL-EIMT	RAPIEnet, Twisted fair 2Ch
RAPIEnet v1	XGL-EIMF	RAPIEnet, Fiber optic 2Ch
	XGL-EIMH	RAPIEnet, Twisted fair, Fiber optic
EtherNet/IP	XGL-EIPT	Industrial Ethernet, Twisted fair 2Ch



Specifications

Item	Description	Standard			
Ambient temperature	0 ~ 55 °C				
Storage temperature	-25 ~ +70 °C				
Ambient humidity	5 ~ 95%RH, (Non-condensing)				
Storage humidity	5 ~ 95%RH, (Non-condensing)				
Vibration resistance	Occasional vibration		10 times each direction (X, Y and Z)	IEC 61131-2	
	Frequency	Acceleration			Pulse width
	10 ≤ f < 57Hz	-			0.075mm
	57 ≤ f < 150Hz	9.8m/s ² {1G}			-
	Frequency	Acceleration			Pulse width
	10 ≤ f < 57Hz	-			0.035mm
Shock resistance	<ul style="list-style-type: none"> • Peak acceleration: 147 m/s{15G} • Duration: 11ms • Half-sine, 3 times each direction per each axis 		IEC 61131-2		
Noise resistance	Square wave impulse noise	± 1,500 V	LSIS Standard		
	Electrostatic discharge	± 4kV	IEC 61131-2, IEC 61000-4-2		
	Radiated electromagnetic field noise	27 ~ 500 MHz, 10 V/m	IEC 61131-2, IEC 61000-4-3		
	Fast transient / Burst noise	0.25kV	IEC 61131-2, IEC 61000-4-4		
Operating Ambience	Free from corrosive gases and excessive dust				
Altitude	Up to 2,000m				
Pollution degree	Less than equal to 2				
Cooling	Air-cooling				

* Pollution degree 2 is nonconductive pollution of the sort where occasionally a temporary conductivity caused by condensation must be expected.

XGK

Item	Description			Remarks
	XGK-CPUUN	XGK-CPUHN	XGK-CPUSN	
Operation method	Cyclic execution of stored program, Time-driven interrupt, Process-driven interrupt			
I/O control method	Batch processing by scan synchronization (Refresh), Direct input/output by instruction			
Program language	Ladder diagram, Instruction list, SFC(Sequential Function Chart), ST(Structured Text)			
Number of instructions	Basic	40		
	Application	700		
Processing speed	LD	0.0085 μ s/Step		
	MOVE	0.255 μ s/Step		
	Real number operation	± : 182.2ns (S), 327.3ns (D)		S: Single real number D: Double real number
		× : 336ns (S), 427ns (D)		
Program capacity	256Kstep (2,048KB)	128Kstep (1,024KB)	64Kstep (512KB)	
I/O points (available to install)	6,144	6,144	3,072	
Data area	P	P00000 ~ P4095F(65,536 points)		
	M	M00000 ~ M4095F(65,536 points)		
	K	K00000 ~ K4095F(65,536 points)		
	L	L0000 ~ L11263F(180,224 points)		
	F	F0000 ~ F4095F(65,536 points)		
	T	100ms : T0000 - T2999		Timer (Adjustable)
		10ms : T3000 - T5999		
		1ms : T6000 - T7999		
		0.1ms : T8000 - T8191		
	C	C0000 ~ C4095		
	S	S00.00 ~ S255.99		
	D	D0000 ~ D524287		D0000 ~ D262143
U	U0.0~U7F.31		U0.0~U3F.31	Special module data refresh area
Z	256 points			
N	N00000 ~ N21503			
R	16 block	8 block	2 block	32K word per 1 block(R0 ~ R32767)
Flash area	2M byte, 32 blocks			Controllable by R device
Program type	Total program	256		
	Initialization	1 (INT)		
	Time-driven	32		
	Internal	32		
Operation mode	RUN, STOP, DEBUG			
Self-diagnosis	Execution, Delay, Memory error, I/O error, Battery error, Power error			Modbus slave
Programming port	RS-232C (1Ch), USB (1Ch)			
Data retention at power failure	Set "retain" at data declaration			
Max. expansion stage	7		3	Total length 15m
Current consumption (mA)	960			
Weight (Kg)	0.12			

XGK

Item	Description					Remarks
	XGK-CPUU	XGK-CPUH	XGK-CPUA	XGK-CPUS	XGK-CPUE	
Operation method	Cyclic execution of stored program, Time-driven interrupt, Process-driven interrupt					-
I/O control method	Batch processing by scan synchronization (Refresh), Direct input/output by instruction					-
Program language	Ladder diagram, Instruction list, SFC (Sequential Function Chart), ST (Structured Text)					-
Number of instructions	Basic	40				-
	Application	700				-
Processing speed	LD	0.028 μs/Step		0.084 μs/Step		-
	MOVE	0.084 μs/Step		0.252 μs/Step		-
	Real number operation	±: 0.602 μs (S), 1.078 μs (D)		±: 1.442 μs (S), 2.87 μs (D)		S: Single real number D: Double real number
		×: 1.106 μs (S), 2.394 μs (D) ÷: 1.134 μs (S), 2.66 μs (D)		×: 1.948 μs (S), 4.186 μs (D) ÷: 1.442 μs (S), 4.2 μs (D)		
Program capacity	128Kstep(512KB)	64Kstep(256KB)	32Kstep(128KB)		16Kstep(64KB)	-
I/O points (available to install)	6,144		3,072		1,536	-
Data area	P	P00000 - P2047F(32,768 points)				-
	M	M00000 - M2047F(32,768 points)				-
	K	K00000 - K2047F(32,768 points)				-
	L	L0000 - L11263F(180,224 points)				-
	F	F0000 - F2047F(32,768 points)				-
	T	10ms : T1000 - T1499 1ms : T2000 - T2047		100ms : T0000 - T0999 1ms : T1500 - T1999		Change area is available by Parameter setting
	C	C0000 - C2047				-
	S	S00.00 - S127.99				-
	D	D0000 - D32,767				-
	U	U0.0-U7F.31	U0.0-U3F.31	U0.0-U3F.31	U0.0-U1F.31	Special module data refresh area
	Z	128 points				-
	N	N00000 - N21503				-
R	2 block		1 block		32K word per 1 block (R0 - R32767)	
Flash area	2M byte, 32 blocks					Controllable by R device
Program type	Total program	256				-
	Initialization	1 (_INT)				-
	Time-driven	32				-
	Internal	32				-
Operation mode	RUN, STOP, DEBUG					-
Self-diagnosis	Execution, Delay, Memory error, I/O error, Battery error, Power error					Modbus slave
Programming port	RS-232C (1Ch), USB (1Ch)					-
Data retention at power failure	Set "retain" at data declaration					-
Max. expansion stage	7	3		1		Total length 15m
Current consumption (mA)	960		940		-	
Weight (Kg)	0.12					-



XGI

Item	XGI-CPUUN	XGI-CPUU/D	XGI-CPUU	XGI-CPUH	XGI-CPUS	XGI-CPUE	Remarks	
Operation system	Reiterative operation, fixed cycle operation, constant scan							
I/O Control system	Scan synchronous batch processing system(refresh system), direct system by command							
Program language	Ladder Diagram, SFC (Sequential Function Chart), ST (Structured Text)							
Operation processing speed (basic command)	Operator	18						
	Basic function	136 types + real number operation function						
	Basic function block	43						
	Dedicated function block	Dedicated function blocks by special function modules, communication dedicated function block(P2P)						
	Basic	0.0085 μ s /step	0.028 μ s /step			0.084 μ s /step		
	MOVE	0.255 μ s /step	0.084 μ s /step			0.252 μ s /step		
Real number operation	\pm : 0.119 μ s(S), 0.281 μ s(D) \times : 0.272 μ s(S), 0.680 μ s(D) \div : 0.281 μ s(S), 0.685 μ s(D)	\pm : 0.392 μ s(S), 0.924 μ s(D) \times : 0.896 μ s(S), 2.240 μ s(D) \div : 0.924 μ s(S), 2.254 μ s(D)			\pm : 1.442 μ s(S), 2.87 μ s(D) \times : 1.948 μ s(S), 4.186 μ s(D) \div : 1.442 μ s(S), 4.2 μ s(D)	S: Single real number D: Double real number		
Program memory capacity	2M	1M	512KB	128KB	64KB			
I/O points (installable)	6,144 points			3,072 points	1,536 points			
Max. I/O memory contact	131,072 points			32,768 points				
Data memory	Symbolic variable area(A)	1024KB (max. 512KB retain setttable)	512KB (max. 256KB retain setttable)		128KB (max. 64KB retain setttable)	64KB (max. 32KB retain setttable)		
	I variable(I)	16KB			4KB			
	Q variable(Q)	16KB			4KB			
	Direct variable	M	512KB (max. 256KB retain setttable)	256KB (max. 128KB retain setttable)		64KB (max. 32KB retain setttable)	32KB (max. 16KB retain setttable)	
		R	64KB \times 16block		64KB \times 2block	64KB \times 1block	32KB \times 1block	
		W	1,024KB		128KB	64KByte	32KByte	R
	Flag variable	F	8KB		4KB			System flag
		K	16KB			4KB		PID flag
		L	22KB					High speed link flag
		N	42KB					P2PParameters
U		8KB			4KB	2KB	Analog data Refresh	
Flash area	2MB, 32block					1MB, 16block		
Timer	No point limit Time range: 0.001~ 4,294,967.295 second(1,193 hours)					20 bytes of symbolic variable area per point		
Counter	No point limit Coefficient range : 64 bit expression					8 bytes of symbolic variable area per point		
Program structure	Total no. of programs	256						
	Initialization task	1						
	Fixed cycle task	32						
	Internal device task	32						
Operation mode	RUN, STOP, DEBUG							
Restart mode	Cold, Warm							
Self diagnosis	Operation delay monitoring, memory fault, I/O fault, battery fault, power fault and etc							
Data protection in case of power failure	Retain area setting by basic parameters							
Max. base extension	7			3	1	Total length 15m		
Current consumption (mA)	960mA			940mA				
Weight (kg)	0.12kg							

**XGK/XGI
CPU built-in
Ethernet
specification**

Item	XGK-CPUSN, CPUHN, CPUUN / XGI-CPUUN	Remarks	
Ethernet	Feature	1 Port	-
		10/100BASE-TX	-
		Auto negotiation (Full-duplex and half duplex)	-
		Auto MDIX Crossover	-
		Max. Support 4 channel	Support 8Kbyte each send and receive channel
		Max. Distance between nodes : 100m	-
		Max. Protocol size : 1500Byte	IP Fragmentation is not supported.
	Cable	UTP, STP, FTP cables is available	FTP, STP is recommended to prevent noise
		Setting communication parameters with XG5000	-
	Service	Loader service (XG5000 connection) supported	Remote stage 1 connection with PLC is available
		LS protocol(XGT) supported.	Server & TCP supported.
		Other company's protocol (Modbus TCP/IP) supported	Client & UDP not supported.



Expansion system composition

1. The following figure is the example of expansion system with the fixed I/O point type of XGK-CPUH.
2. The address of I/O point is adjustable by XG5000 parameter.

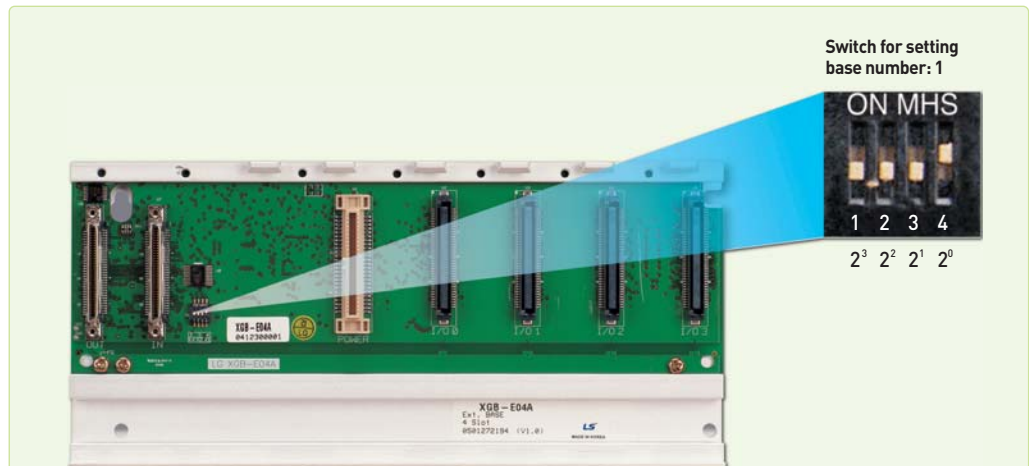

The lowest expansion base should be connected to the upper stage with expansion terminator(XGF-TERA).

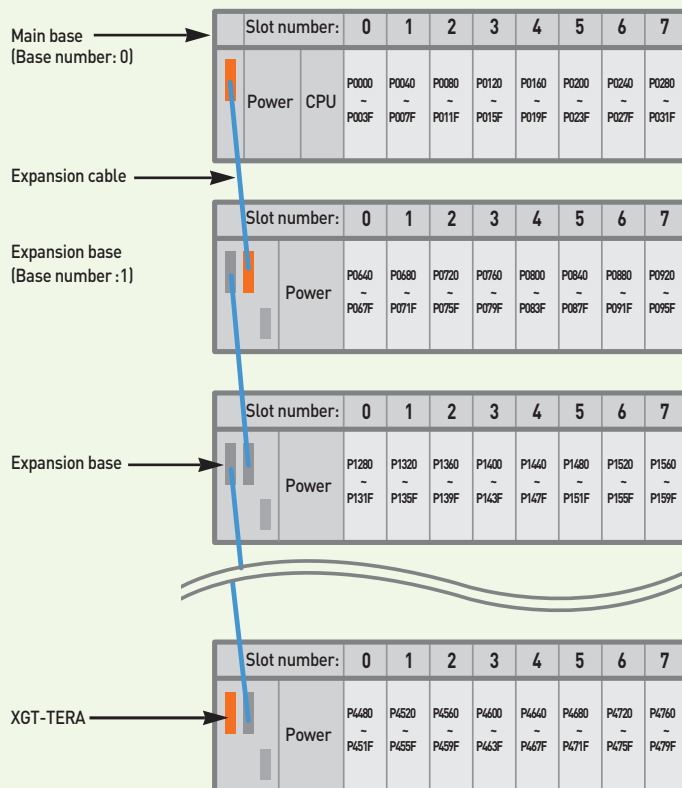

XGT-TERA should be installed at the end of the last expansion base.



Features

- 8, 16, 32, 64 points I/O module
- Operation monitoring by LED display
- Easy maintenance: Terminal block type, one-touch installation of module



Input module specifications

Item	DC input							AC input		
Type	XGI-D21A	XGI-D22A	XGI-D22B	XGI-D24A	XGI-D24B	XGI-D28A	XGI-D28B	XGI-A12A	XGI-A21A	XGI-A21C
Input point	8	16		32		64		16	8	8
Rated input voltage	DC24V							AC100-120V	Free voltage	DC100/240V
Rated input current	4mA							8mA	17mA	17mA
ON voltage/current	19V or more / 3mA or less							AC80V or more / 5mA or less	AC130V or more / 10mA or less	AC80V or more / 5mA or less
OFF voltage/current	DC11V or more / 1.7mA or less							AC80V or more / 5mA or less	AC60V or more / 2mA or less	AC30V or more / 1mA or less
Response	Off→On	1ms/5ms/10ms/20ms/70ms (set by CPU parameter) Initial value: 3ms					15mA or less			
	On→Off	1ms/5ms/10ms/20ms/70ms (set by CPU parameter) Initial value: 3ms					25mA or less			
Common (COM)	8 points/COM	16 points/COM		32 points/COM				16 points/COM	8 points/COM	1 points/COM
Insulation method	Photocoupler							Photocoupler		
Current consumption (mA)	20	30		50		60		30	20	20
Weight (Kg)	0.1	0.12		0.1		0.15		0.13	0.13	0.13

Output module specifications

Item	Relay			Transistor						Triac	
Type	XGQ-RY1A	XGQ-RY2A	XGQ-RY2B	XGQ-TR1C	XGQ-TR2A	XGQ-TR2B	XGQ-TR4A	XGQ-TR4B	XGQ-TR8A	XGQ-TR8B	XGQ-SS2A
Output point	8	16		8	16		32		64		16
Rated input voltage	DC12/24V, AC110/220V			DC12/24V							
Rated input current	1 Point	2A		2A	0.5A	0.1A				0.6A	
	Common	5A		0.1A	4A	2A				4A	
Response time	Off→On	10ms or less		3ms or less	1ms or less					1ms or less	
	On→Off	12ms or less		10ms or less	1ms or less					0.5cycle +1ms or less	
Common (COM)	1 point/COM	16 points/COM		1 points/COM	32 points/COM						16 points/COM
Insulation method	Relay			Photocoupler							
Current consumption (mA)	260	500		100	70	130				230	300
Weight (Kg)	0.13	0.17	0.19	0.11	0.11	0.1				0.15	0.2
Surge killer	-		Varistor	Zener diode							Varistor
External power supply	-			DC12/24V						DC	-

Note) B1, B2 of 32, 62 points terminal (connector) are shorted inside of the product.

Wiring diagram for input modules

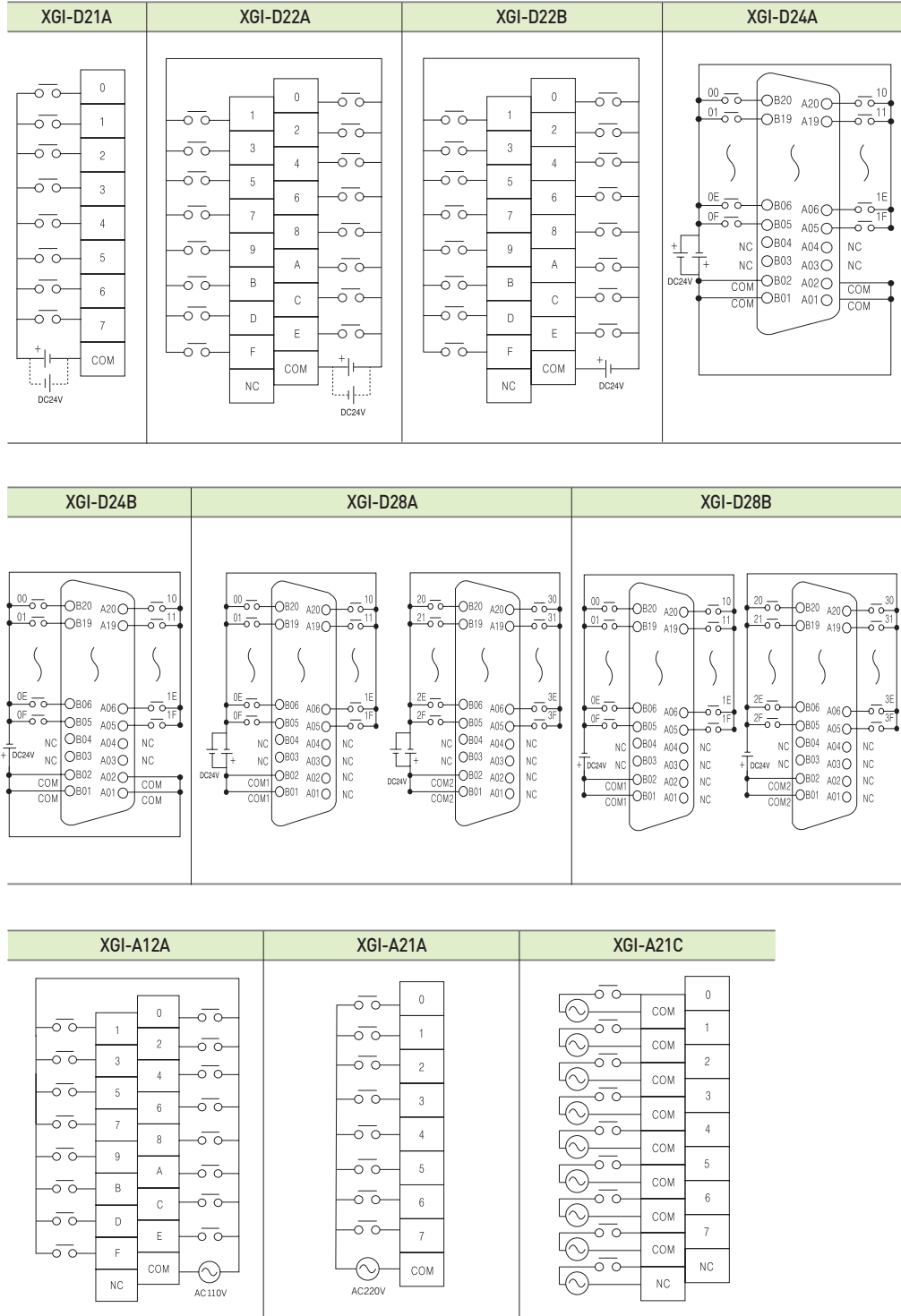

Wiring diagram for output modules

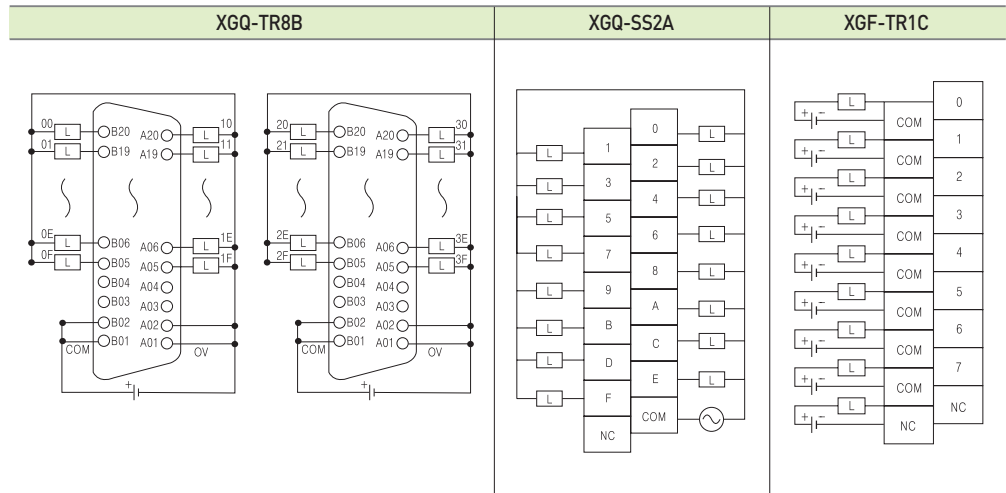
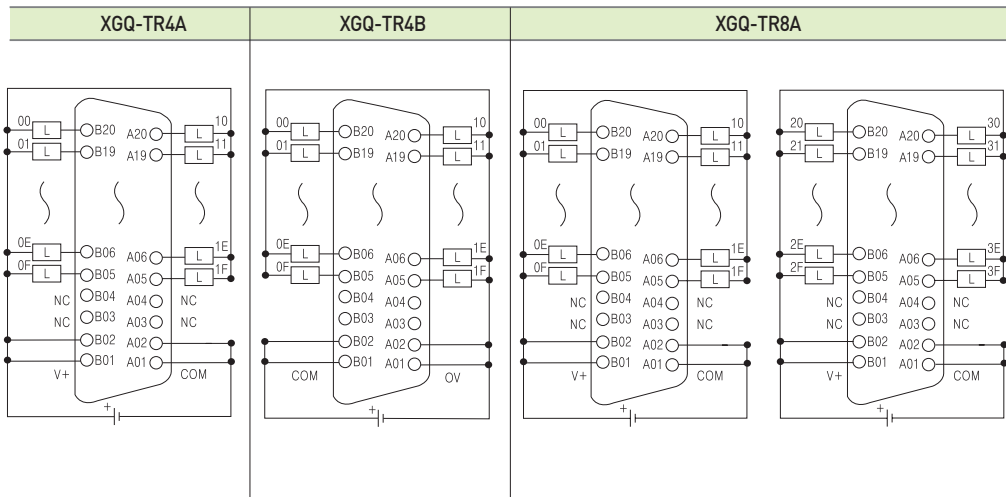
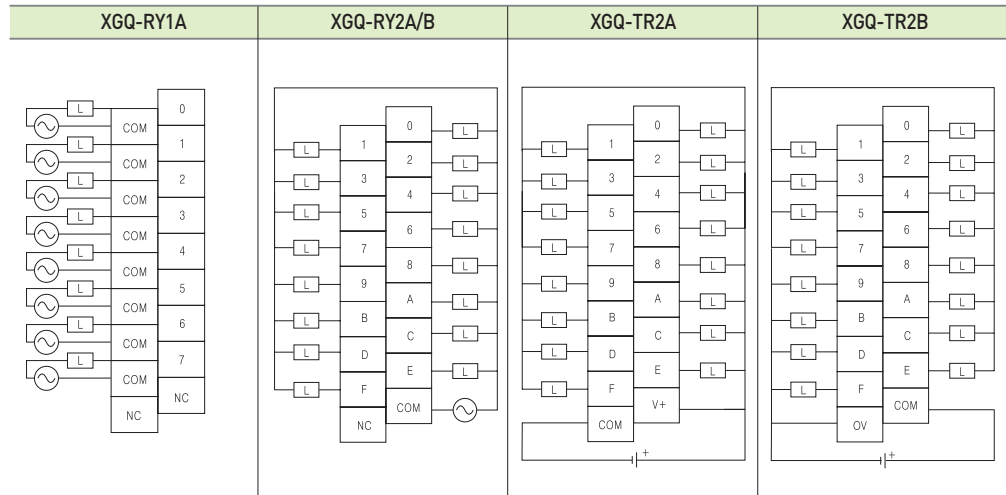



Diagnostic Digital Input Module(XGI-D21D)

- Diagnostic Digital Input module receives and processes DC 24V input signal. It has a wire break detection function of each input signal.
- Input signal and wire break detection signal are displayed on the device of the CPU module, it can be used in the PLC program.

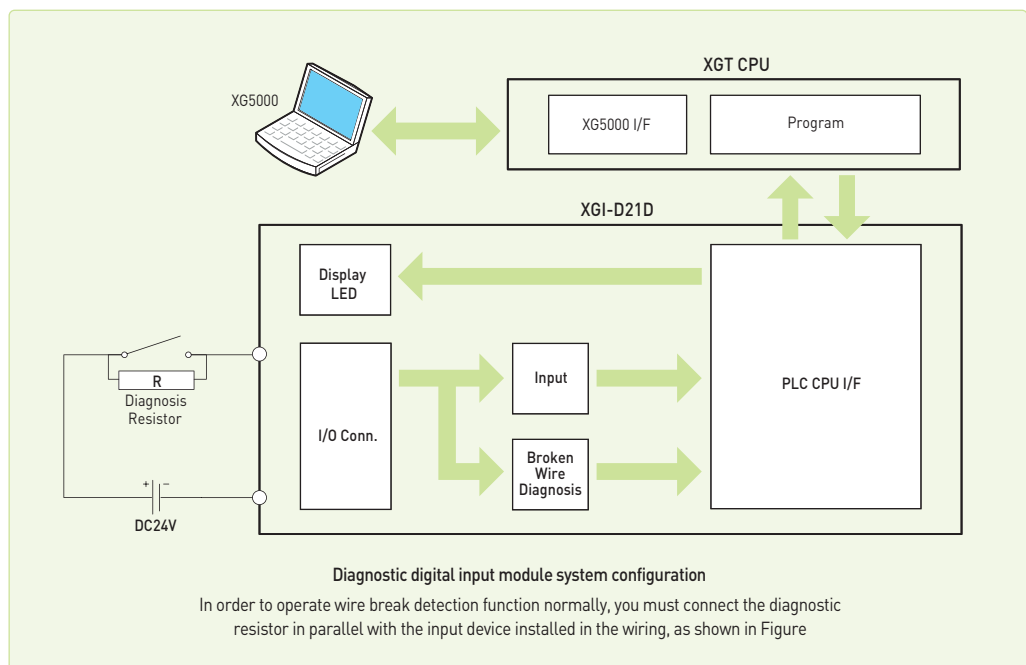

Specifications

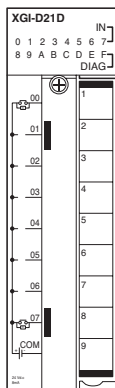

- IN: Input status(0-7)
- On: Input On
 - Off: Input Off
- DIAG: Diagnosis status(8-F)
- On: broken wire occurs
 - Off: Normal state

Item	Specifications
Input point	8 points
Insulation method	Photo coupler insulation
Rated input voltage / current	DC24V / Approx. 8mA
Voltage range	DC20.4~28.8V (5% and lower ripple rate)
On voltage / On current	19V and higher / 5.2mA and higher
Off voltage / On current	11V and lower / 4.7mA and lower
Response time (Input filter)	Off → On: 1ms/3ms/5ms/10ms/20ms/70ms/100ms, Initial value:3ms On → Off: 1ms/3ms/5ms/10ms/20ms/70ms/100ms, Initial value:3ms
Insulation withstand voltage	DC 500V
Insulation resistance	10 Ω and higher by Insulation ohmmeter
Diagnosis function	Wire break detection
Common method	8 point / 1COM
Suitable cable size	Stranded cable between 0.3~0.75mm ² (2.8mm and smaller outer dia.)
Suitable clamped terminal	R1.25-3 (Sleeve built-in clamped terminal is not available)
Current consumption(mA)	60mA
Operation display	LED On with input On LED On during wire break
External connection method	9 point Terminal strip connector (M3 X 6 screws)
Weight	95g



Diagnostic Digital Output Module(XGQ-RY1D)

- Diagnostic digital output module outputs output signal via the relay to the outside. It has a diagnostic function of the internal signal and wire break detection for each output signal.
- Diagnostic signals are displayed on the device of the CPU module, it can be used in the PLC program.

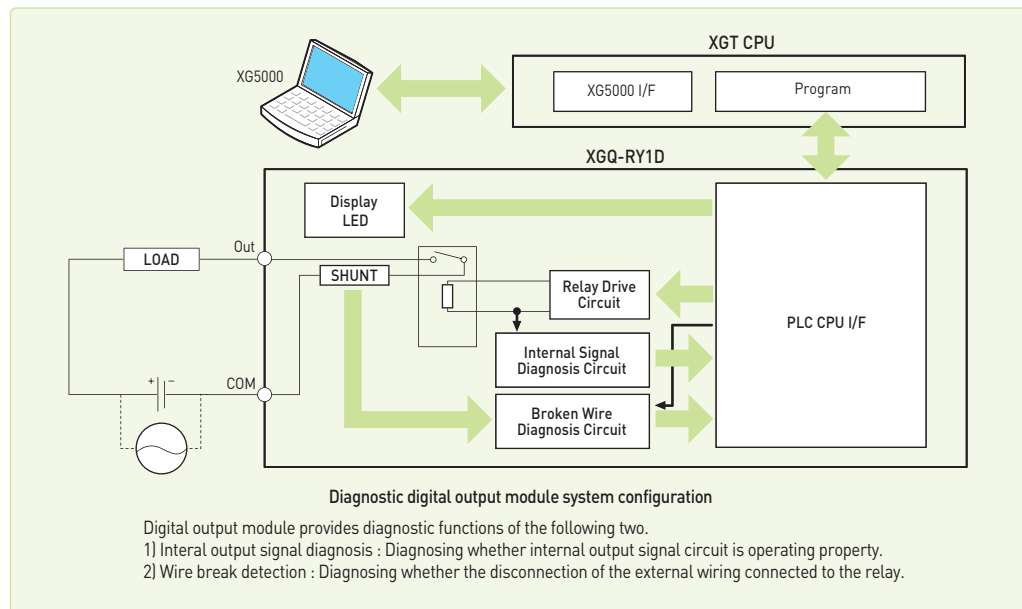

Specifications

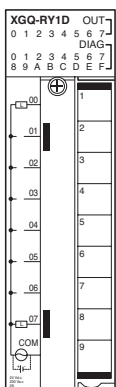

- OUT:** Output status (0 ~ 7)
- On: Relay output On
 - Off: Relay output Off
- DIAG :** Diagnosis status
- Internal output signal diagnosis (0 ~ 7)
- On: Internal output signal fail
 - Off: Normal state
- Wire break detection(8~F)
- On: broken wire occurs
 - Off: Normal state

Item	Specifications	
Output point	8 points	
Insulation method	Relay insulation Photo coupler insulation	
Rated load voltage	DC24V (resistance load) / AC220V (COS ψ = 1)	
Rated load current	1point 2A	
	Common 5A	
Min. load voltage / current	DC5V / 1mA	
Max. load voltage / current	AC250V, DC125V / 2A	
Leakage current at Off	0.1mA (AC220V, 60Hz)	
Max. switching frequency	1,800 times/hour	
Surge killer	None	
Life	Mechanical 20 million and more times	
	Electrical	Rated load voltage/current 100 thousand and more times
		AC200V / 1.5A, AC240V / 1A (COS ψ = 0.7) 100 thousand and more times
		AC200V / 1A, AC240V / 0.5A (COS ψ = 0.35) 100 thousand and more times
Response time	DC24V / 1A, DC100V / 0.1A (L / R = 7ms) 100 thousand and more times	
	Off \rightarrow On 10ms and lower	
On \rightarrow Off 12ms and lower		
Diagnosis function	Wire break detection Internal output signal diagnosis	
Common method	8 point/1COM	
Current consumption(mA)	Max. 400mA	
Operation display	LED On with output On LED On during wire break LED On when the internal output signal fail	
External connection method	9 point Terminal strip connector (M3 X 6 screws)	
Weight	145g	

Input/output mixed Type (XGH-DT4A)

Input		Output		
Input points	16 points	Input points	16 points	
Insulation method	Photo coupler	Insulation method	Photo coupler	
Rated input voltage	DC24V	Rated input voltage	DC12/24V	
Rated input current	4mA	Rated input current	DC10.2-26.4V	
Input voltage range	DC20.4-28.8V	Input voltage range	0.1A/point, 1.6A/COM	
Insulation pressure	AC560Vrms / 3Cycle	Insulation pressure	0.1mA or less	
On voltage/current	DC19V or more / 3mA or more	On voltage/current	0.7A/10ms or less	
Off voltage/current	DC11V or more / 1.7mA or more	Off voltage/current	Zener diode	
Input resistance	5.6kΩ	Input resistance	DC 0.2V or less	
Response	Off → On	1ms/3ms/5ms/10ms/20ms/70ms/100ms (Setting by CPU parameter)	Off → On	1ms or less
		Initial value: 3ms		
	On → Off	1ms/3ms/5ms/10ms/20ms/70ms/100ms (Setting by CPU parameter)	On → Off	1ms or less (rated load, resistance load)
		Initial value: 3ms		
Common (COM)	16 points/COM			
Operation display	LED lighting when output is ON			
Internal current consumption	100mA			
External connection	40-point connector			
Weight (kg)	0.1			

Wiring diagram for mixed type

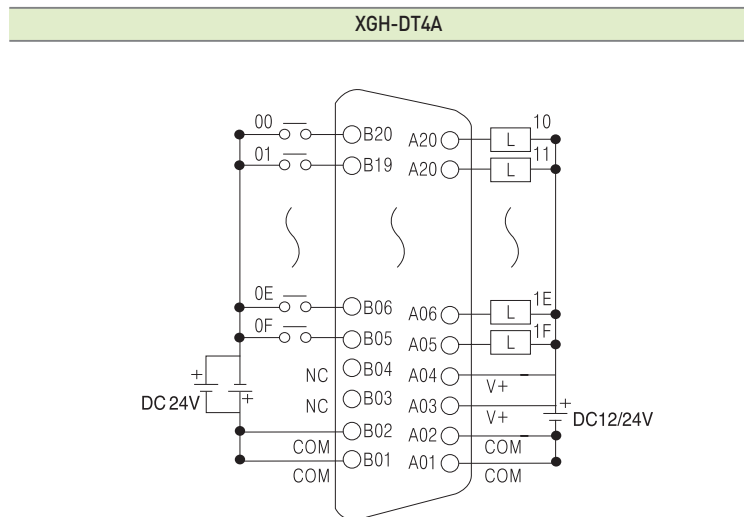

NOTE] Input address for XGK CPU is P00-P0F and Output address is P10-P1F when it is installed on the slot 0.
 Input address for XGI CPU is %IX0.0.0-%IX0.0.15 and Output address is %QX0.0.16-%QX0.0.31

Precaution during installation of I/O module

- XGT has 2 kinds of digital input type: Current sink input, Current source input. For DC input module has different wiring depending on the input type, digital input type should be selected with consideration about connected input device.
- Max. number of simultaneous input point differs according to the module type. Therefore, review specification of input module before its application.
- Use an interrupt module when a response of high-speed input is demanded. But only one interrupt module can be installed per CPU module.
- If switching frequency is high or inductive switching load is used, the lifespan of relay output module will be reduced. Therefore, it is recommended to use transistor output module or triac output module.
- When driving an inductive load with output module, set the maximum switching frequency as 'ON' for 1 second and 'OFF' for 1 second.
- When using counter or timer with DC/DC converter, it is possible to have inrush current which cause a break down. Therefore to reduce an effect of inrush current, connect resistor or inductor to load or use the module whose max. load current is high.

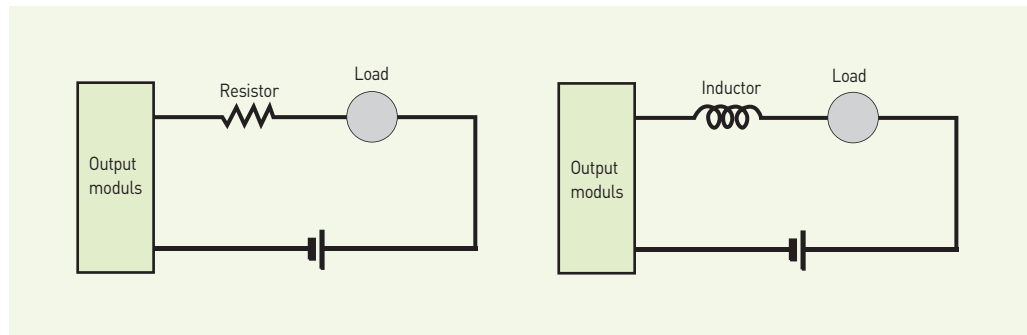

- Fuse of output module is not exchangeable to prevent a damage of external wiring when output module has a short-circuit.
- The number of simultaneous 'ON' points varies depending on input voltage, ambient temperature. Refer to the specification of input module.
- The following graph presents the relay lifespan of relay output module. It shows the maximum lifespan of relay which is used in the relay output.

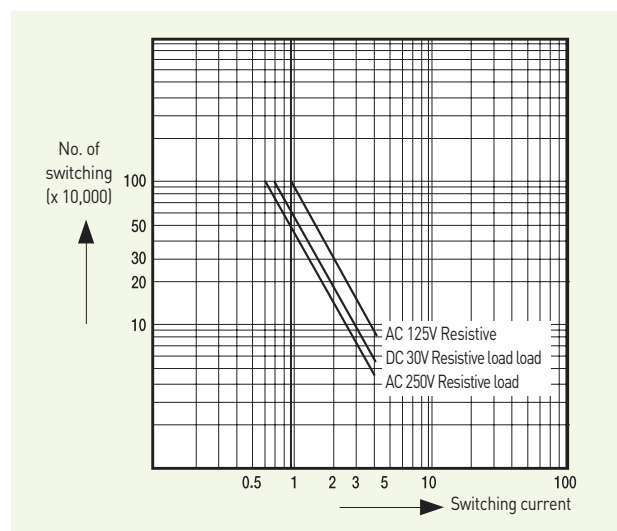

- Compressed terminal attaching sleeve cannot be mounted to XGT terminal block. The following picture shows appropriate compressed terminals for terminal block.

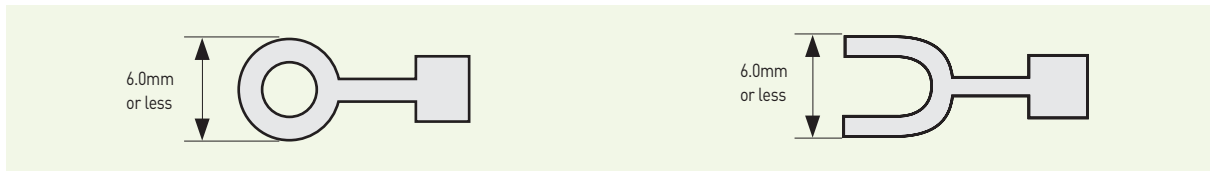

- Use 0.3~0.75mm twisted pair, below 2.8mm thickness cable for connecting to terminal block.
- Be careful when choosing and using the cable since the permissible current differs according to the insulation thickness.
- Joint torque of fixed screw and terminal block screw of the module needs to be within the range in the following table.

Joint	Joint torque range
I/O module terminal block screw (M3)	42-58 N-cm
I/O module terminal block fixed screw (M3)	68-89 N-cm

- Thermal protector is built in transistor module. Thermal protector is a function that protects PLC from an overload and overheating.







XGR Redundancy System

Redundancy system for high-speed process control based on IEC

- Processing speed: 42ns/step
- I/O Points: Max. 131,072
- Total memory: 25MB (Program 7MB, Data 2MB, Flash 16MB)
- Switching over time: Min 4.3ms, Max 22ms
- Built-in 256 PID loops control

Contents	34	XGR Configuration
	36	System configuration
	38	Application



XGR Configuration

- Base, Power, CPU, Network redundancy
- Dual port and 3 kinds of media (Twisted-Twisted, Optic-Optic, Twisted-Optic)

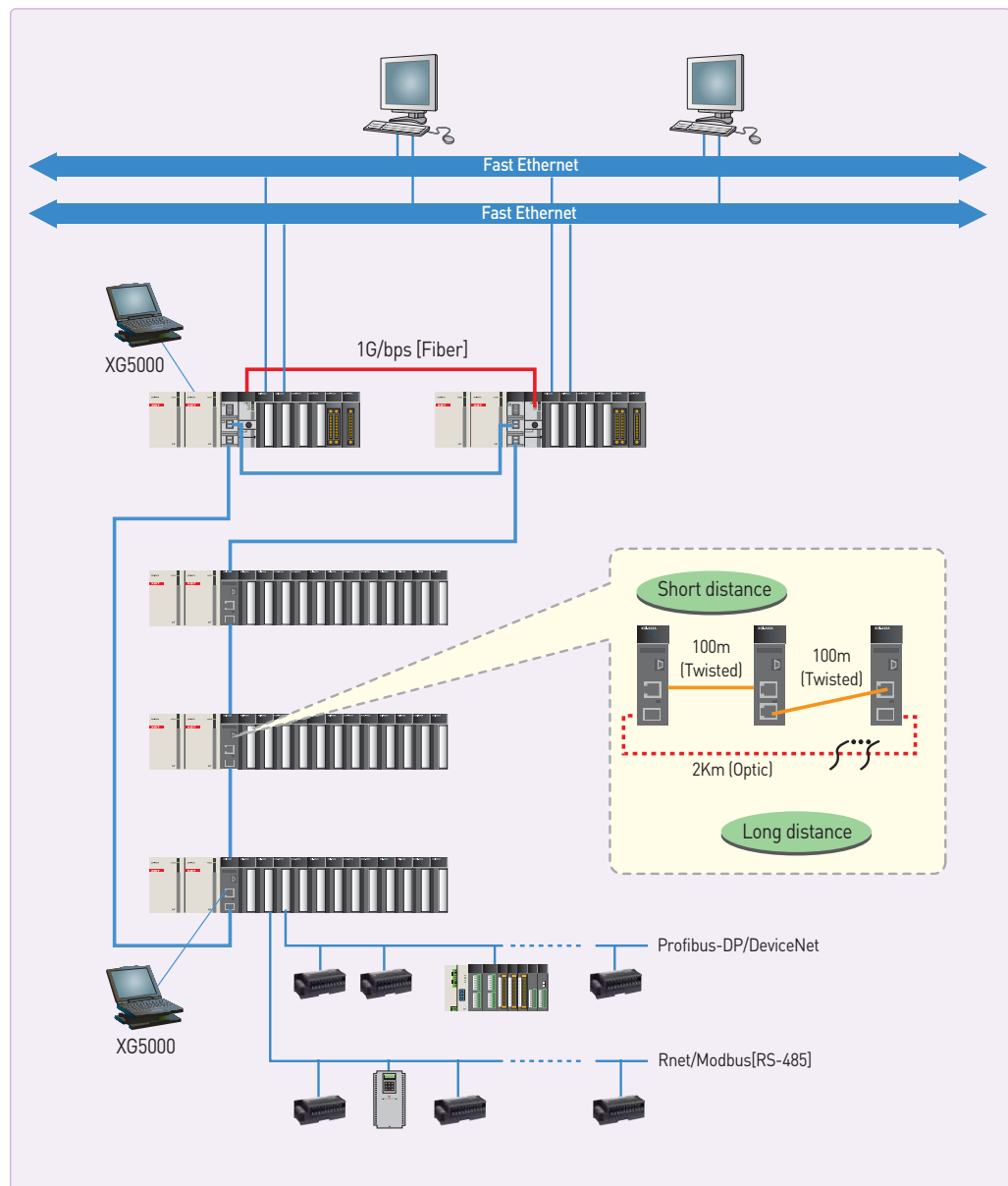

System configuration method

Fiber-optic

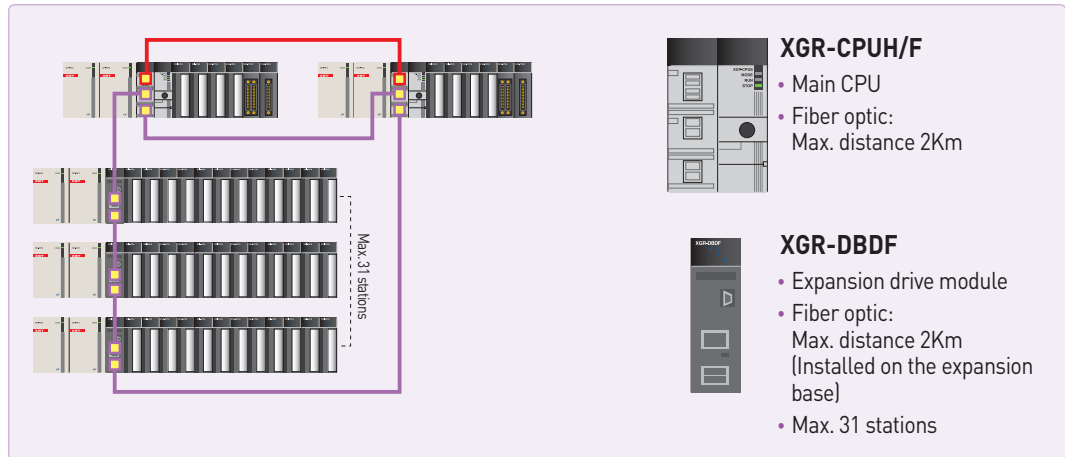

Twisted pair

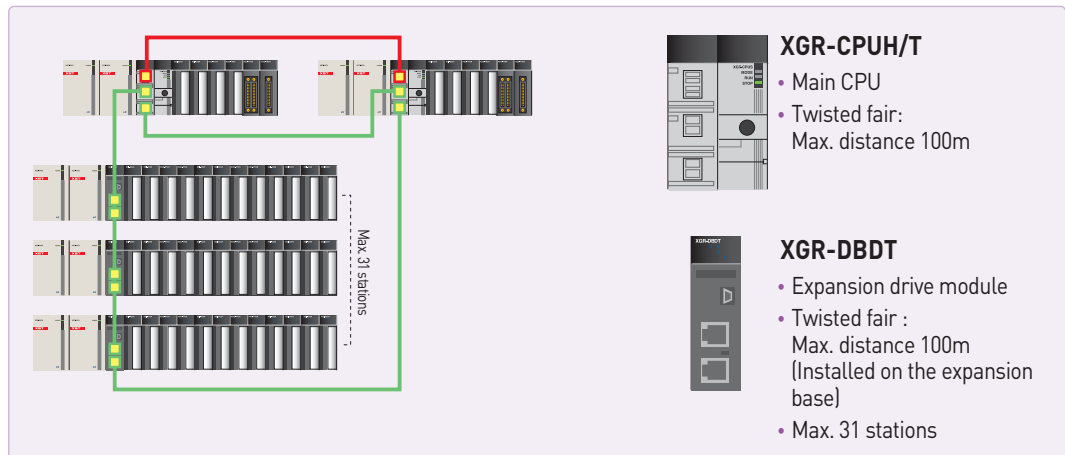

Hybrid (Twisted pair + Fiber Optic)

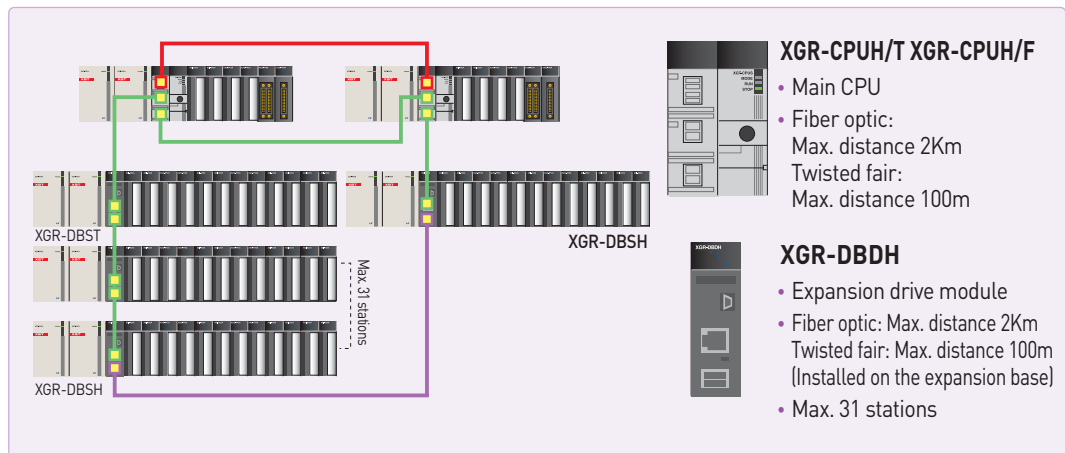

* Max. expandable distance: Fiber optic 60km, Twisted pair 3km

* CPU synchronization cable: 2m, 5m

System configuration

Main base

- 2 types of CPU (Fiber optic, Twisted fair)
- Power: AC110V, AC220V
- 6slot base: enable to install 6 communication modules

Expansion base

- Power: 8.5A/AC110V, 8.5A/AC220V
- Expansion drive: Fiber optic, Twisted fair, Hybrid
- EFM* and EIM*: not available with 12slot base

XGR module		
CPU	XGR-CPUH/T	Twisted pair
	XGR-CPUH/F	Fiber optic(2km)
	XGR-CPUH/S	Fiber optic(15km)
Power	XGR-AC12	110V, 5.5A(Main base)
	XGR-AC13	110V, 8.5A(Expansion base)
	XGR-AC22	220V, 5.5A(Main base)
	XGR-AC23	220V, 8.5A(Expansion base)
	XGR-DC42	DC24V/DC5V 7A, Main(Expansion base)
Base	XGR-M02P	2Slot(Main base)
	XGR-M06P	6Slot(Main base)
	XGR-E08P	8Slot(Expansion base)
	XGR-E12P	12Slot(Expansion base)
	XGR-E12H	12Slot(Expansion base, Drive Redundancy)
Expansion drive	XGR-DBST	Twisted pair - Twisted
	XGR-DBSF	Pair Fiber optic - Fiber optic(2km)
	XGR-DBSH	Twisted pair - Fiber optic(2km)
	XGR-DBSFS	Pair Fiber optic - Fiber optic(15km)
	XGR-DBSHS	Twisted pair - Fiber optic(15km)

XGR module		
Expansion drive redundancy	XGR-DBDT	Twisted pair - Twisted
	XGR-DBDF	Pair Fiber optic - Fiber optic(2km)
	XGR-DBDH	Twisted pair - Fiber optic(2km)
Sync & Expansion cable	XGC-F201	2m (Fiber optic)
	XGC-F501	5m (Fiber optic)

Item	Input module		
	AC110V	AC220V	DC24V
8 points	-	XGI-A21A, XGI-A21C	XGI-D21A
16 points	XGI-A12A	-	XGI-D22A
	-	-	XGI-D22B
32 points	-	-	XGI-D24A
	-	-	XGI-D24B
64 points	-	-	XGI-D28A
	-	-	XGI-D28B

Item	Output module		
	Relay	Triac	Transistor
8 points	XGQ-RY1A	-	XGQ-TR1C
	XGQ-RY2A	XGQ-SS2A	XGQ-TR2A
16 points	XGQ-RY2B	-	XGQ-TR2B
	-	-	XGQ-TR4A
32 points	-	-	XGQ-TR4B
	-	-	XGQ-TR8A
64 points	-	-	XGQ-TR8B

Item	Input/Output mixed module	
	16-point DC input	16-point TR output

Special module		
Analog input	XGF-AV8A	Voltage input type, 8Ch
	XGF-AC8A	Current input type, 8Ch
	XGF-AD8A	Voltage/ Current input, 8Ch
	XGF-AD4S	Voltage/ Current input, 4Ch (Isolated)
Analog output	XGF-AD16A	Voltage/ Current input, 16Ch
	XGF-AW4S	2-wire, Voltage/ Current input, 4Ch (Isolated)
	XGF-DV4A	Voltage output type, 4Ch
	XGF-DC4A	Current output type, 4Ch
	XGF-DV8A	Voltage output type, 8Ch
	XGF-DC8A	Current output type, 8Ch
	XGF-DV4S	Voltage output, 4Ch (Isolated)
	XGF-DC4S	Current output, 4Ch (Isolated)
Analog Input/Output	XGF-AH6A	Input: 4ch, Voltage/ Current Output: 2Ch Voltage/ Current
High-speed counter	XGF-HO2A	Pulse (OC) input type, 2Ch
	XGF-HD2A	Pulse (LD) input type, 2Ch
Positioning	XGF-PD1H-PD4H	Open collector, 1~4axes
	XGF-PD1H-PD4H	Line drive, 1~4axes
Positioning (Network Type)	XGF-PN8A	LS Standard EtherCAT Net. 8axes
	XGF-PN8B	Standard EtherCAT Net. 8axes
Motion module	XGF-M32E	Standard EtherCAT Net. 32axes
Temperature control	XGF-TC4S	Thermocouple input, 4Ch
	XGF-RD4A	RTD input, 4Ch
	XGF-RD4S	RTD input, 4Ch (Insulated)
Temperature controller	XGF-TC4UD	Input: 4ch.(Voltage/Current, RTD/TC) Output: 8ch.(TR/Current) Controller: 4 loops
	XGF-TC4RT	Input: 4ch.(RTD) Output: 4ch.(TR) Controller: 4 loops
Event input	XGF-SOEA	DC24V, 32points

Communication module		
RAPIEnet+	XGL-EFMTB	Master/Client, Twisted fair 2ch.
	XGL-EFMFB	Master/Client, Fiber optic 2ch.
	XGL-EFMHB	Master/Client, Twisted fair/fiber optic
	XGL-ES4T	Stand alone switch twisted pair 4ch.
-EtherNet/IP	XGL-ES4H	Stand alone switch twisted pair 2ch. fiber 2ch.
	XGL-EH5T	Open Ethernet switching hub
Computer Link (Cnet)	XGL-CH2B	RS-232C 1ch, RS-422/485 1ch
	XGL-C22B	RS-232C 2ch
	XGL-C42B	RS-422/485 2ch
DeviceNet(Dnet)	XGL-DMEB	DeviceNet, Master
Profibus-DP (Pnet)	XGL-PMEB	Profibus-DP, Master
	XGL-PSRA	Profibus-DP Slave, Remote interface
	XGL-PSEA	Profibus-DP Slave
Rnet	XGL-RMEB	Rnet, Master, TP
	GOL-RR8T	Rnet stand alone repeater hub
Fnet	XGL-FMEA	Fnet, Master
BACnet/IP	XGL-BIPT	BACnet client/server

Specification

Item		Description		Remark
		XGR-CPUH/F	XGR-CPUH/T	
Media		Fiber optic	Twisted pair	
Operation method		Cyclic execution, Periodic operation, Interrupt operation, Fixed scan		
I/O control method		Scan synchronized batch processing method (Refresh method)		
Program language		LD (Ladder Diagram), ST (Structured Text), SFC (Sequential Function Chart), IL (Read only)		
Number of Instructions	Operator	18		
	Standard function	130 + Real type function		
	Standard function block	41		
Special function/ function block		Special function block, Process control function block		
Processing speed	LD	0.042 μ s/Step		
	MOV	0.126 μ s/Step		
	Real type	\pm : 0.602 μ s(S), 1.078 μ s(D) x : 1.106 μ s(S), 2.394 μ s(D) \div : 1.134 μ s(S), 2.66 μ s(D)		S: Real type D: Long real type
I/O points		I: 131,072 points, Q: 131,072 points (Total: 1131,072)		
DRAM	Program memory	7MB		Including Upload, Parameter, System area *Battery back-up memory : 8MB
	Data memory	2MB		
	Reserved memory	7MB		
Flash memory		16MB		
Data memory	Direct variable	256k Byte		
	Auto allocated variable	512k Byte		
	Timer	No limitation, Range: 0.001sec ~ 4,259,967.295sec (1,193hours)		
	Counter	No limitation, Range: -32,768 ~ +32,767		
	Flag	System	4k Byte	
Communication		64k Byte		L, N area
Special		2k Byte (32 base, 16 slot, 32 channel)		U area: Analog device area
File register		64k Byte *2		Rarea: read/write (Command, XG5000)
Program	Number of program blocks	256		
	Initial task	1 (_INT)		
	Cycle task	32		
	Internal device task	32		
Operation mode		RUN, STOP, DEBUG		
Restart mode		Warm, Cold		
Self diagnostic functions		Watchdog timer, Memory error, I/O error, Battery error, Power Supply error		
Program download		RS-232C (1CH), USB (1CH)		
Data retain		Auto allocated variable: set by variable definition Direct variable: set by parameter		
Max. expansion base		31 stages		

Specification

Item	Hardware	Remark
CPU module	2 slot / Fiber, Twisted fair	
Expansion drive module	1 slot / Fiber, Twisted fair, Hybrid	
Base	Main base: 6 slot, Expansion base: 12 slot	
Power	AC110V	5V-5.5A
	AC220V	5V-5.5A
	AC110V	5V-8.5A
	AC220V	5V-8.5A
Expansion method and Max. expansion base	31 stages by network	
Base number setting	Rotary switch of expansion drive module	
Distance between expansion bases	Twisted fair: 100m (3km), Fiber: 2km (60km)	
Master/Standby switching over time	50ms or less	

Available modules for each base

	Base	Available modules
1	Main base	CPU, Ethernet module (XGL-EFMx), RAPIenet module (XGL-EIMx) * x: T (Twisted fair), F (Fiber optic), H (Hybrid)
2	Expansion base	I/O modules for XGI (Ethernet based communication module should be installed on Main base Number of communication module: 12 for High-speed link, 8 for P2P Number of analog module: Analog input (139), Analog output (250)



Water power generation or Dam door control

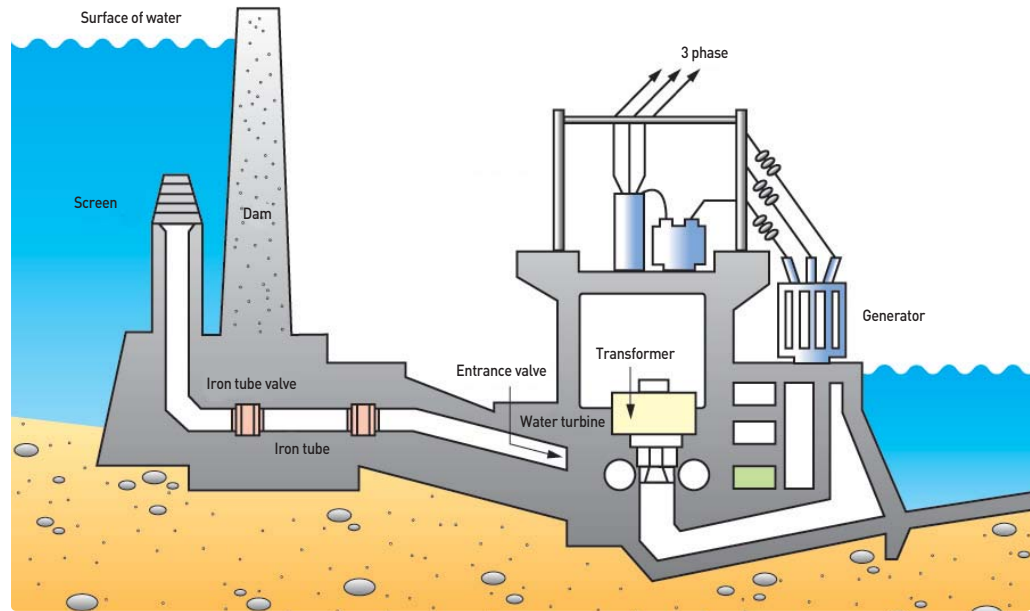

System configuration

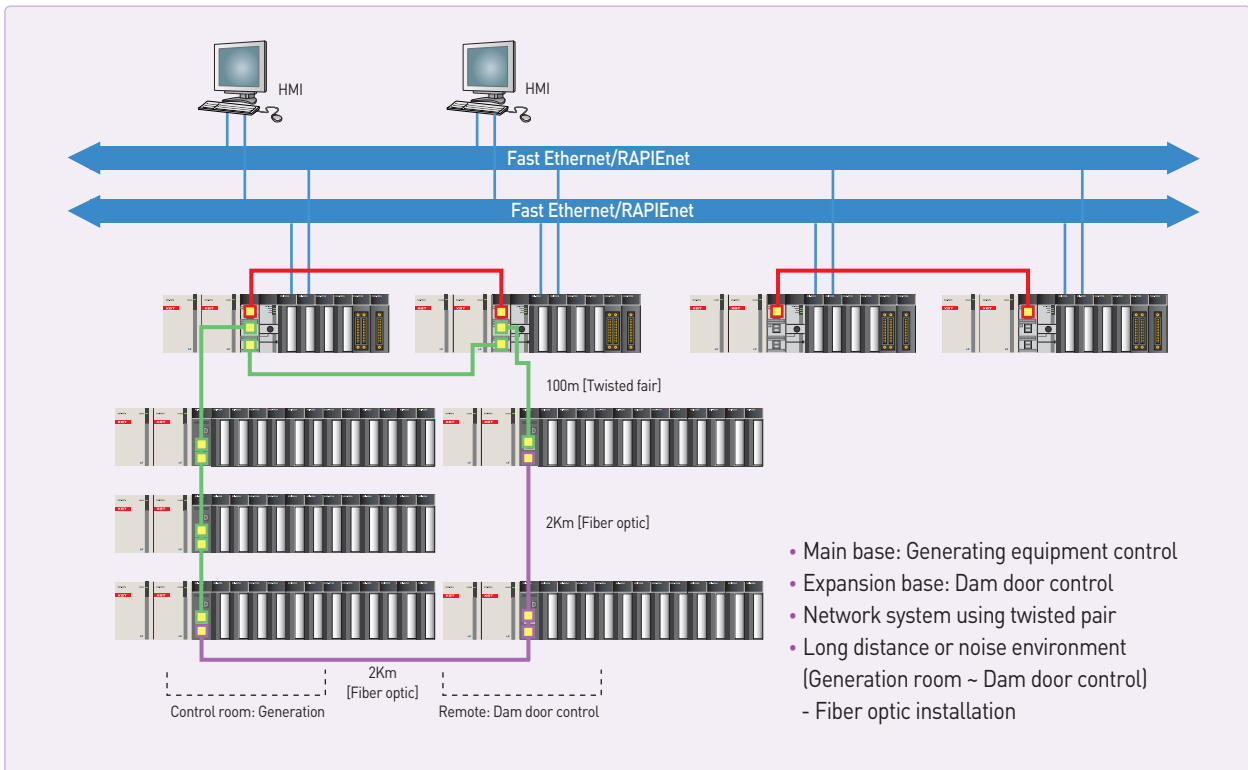

Generating boiler control

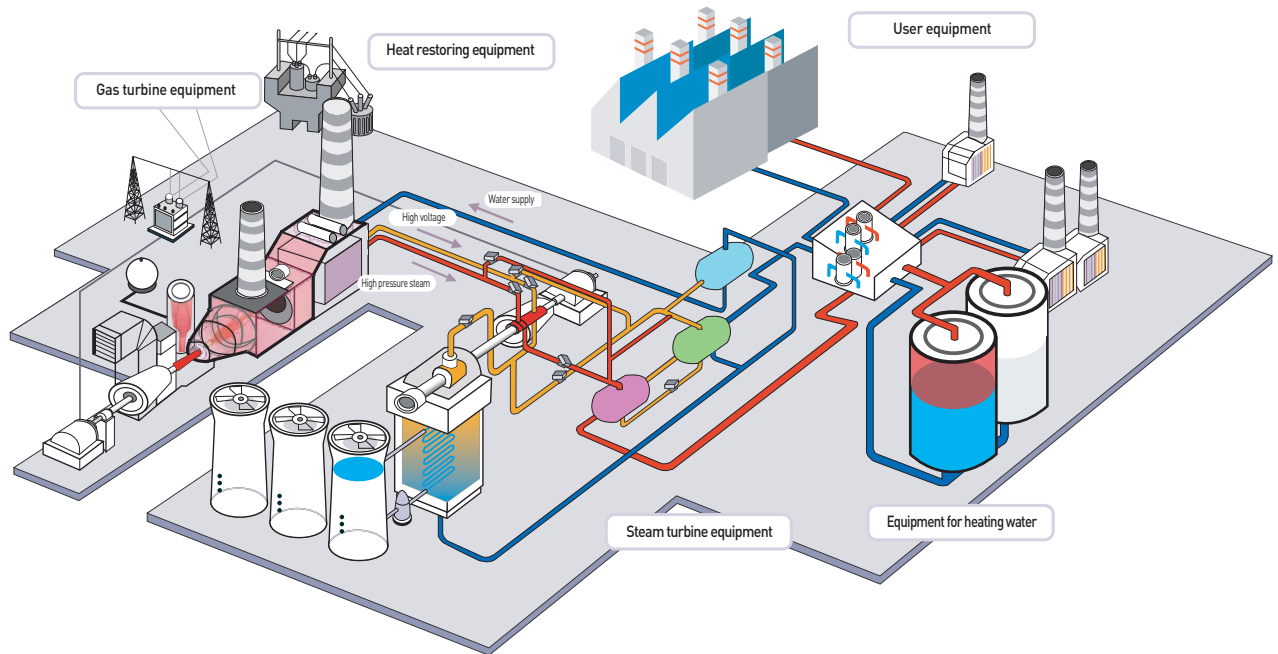

SYSTEM

System configuration

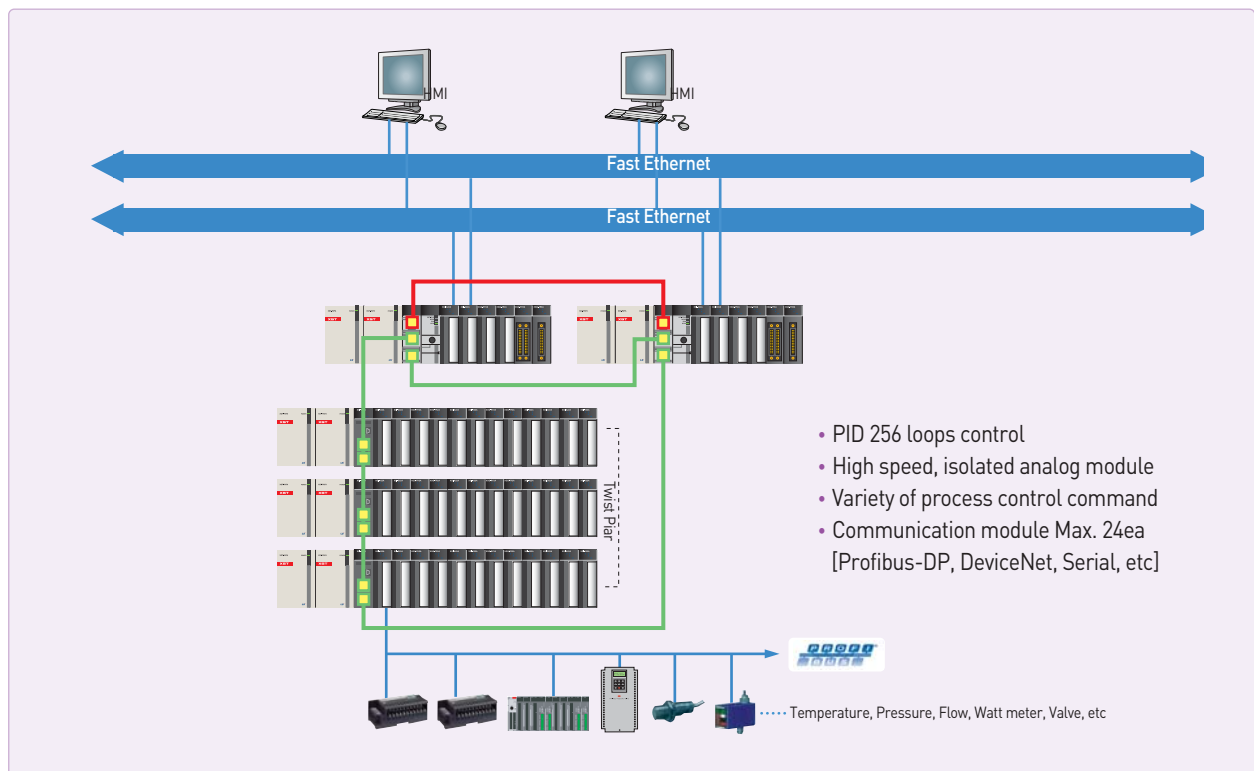

Stage control

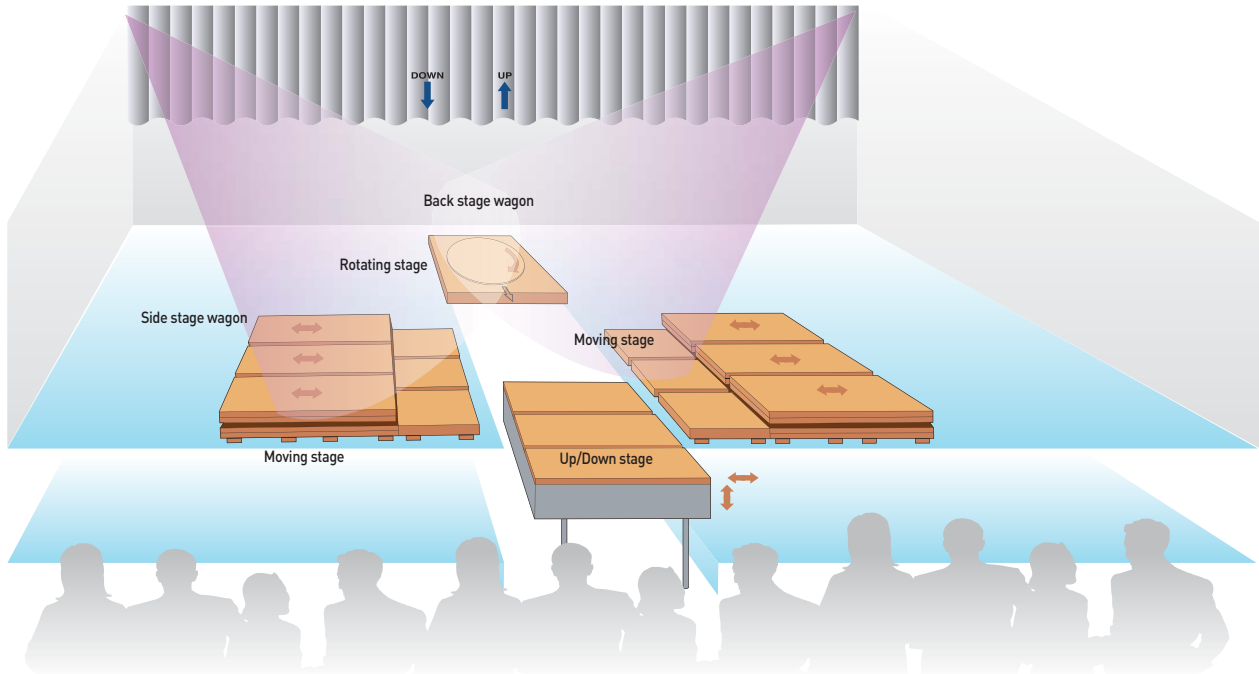

System configuration

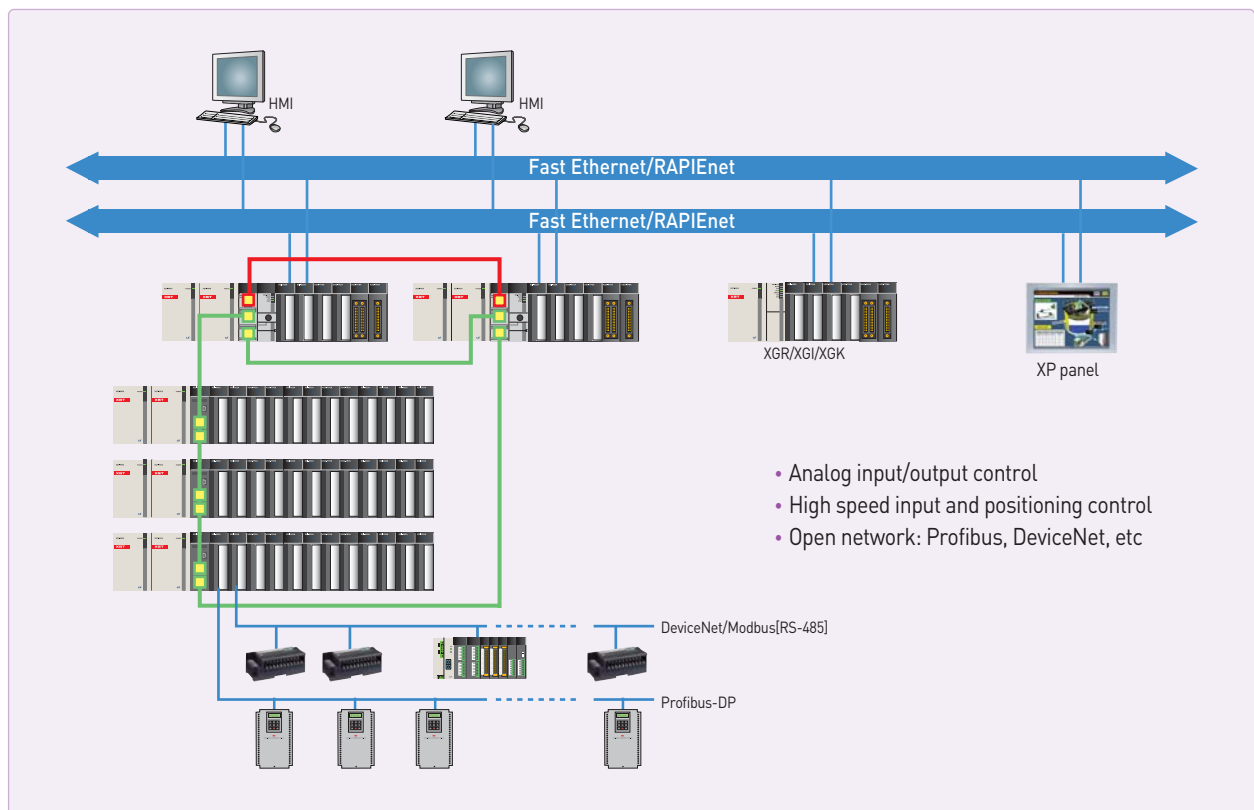

Water processing control

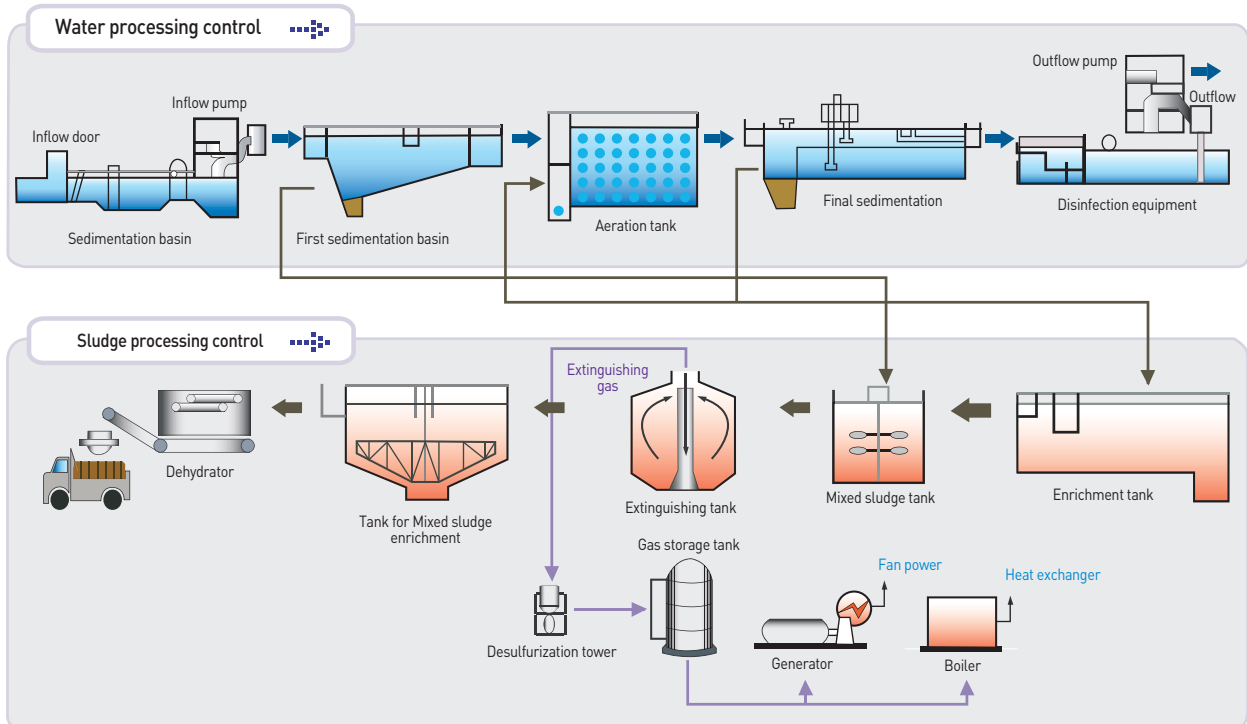

SYSTEM

System configuration

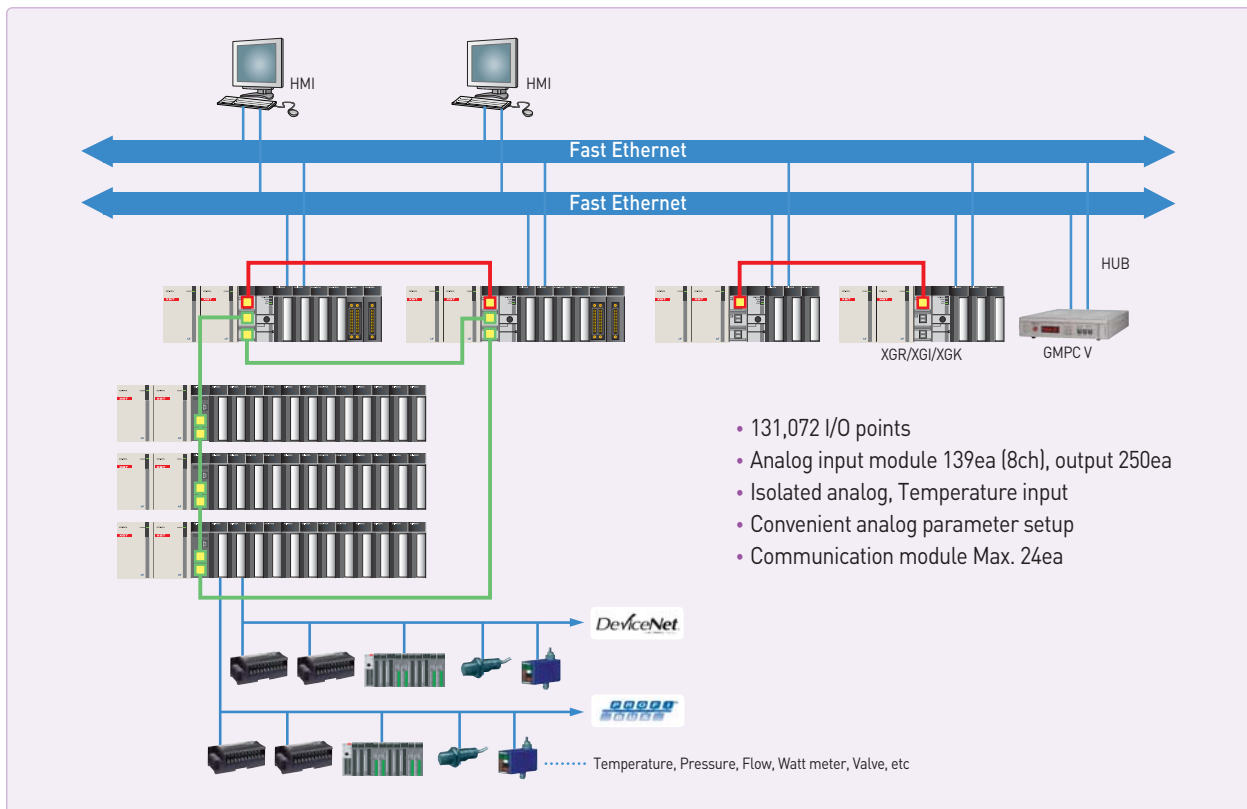

Incinerator control

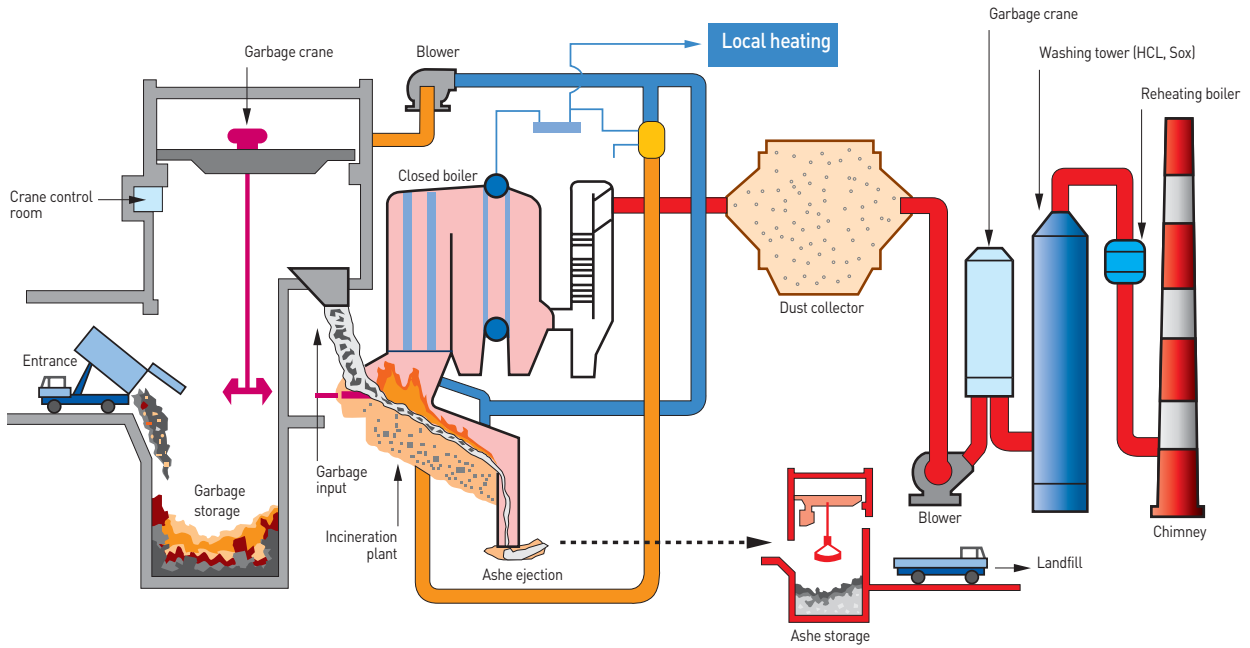

System configuration

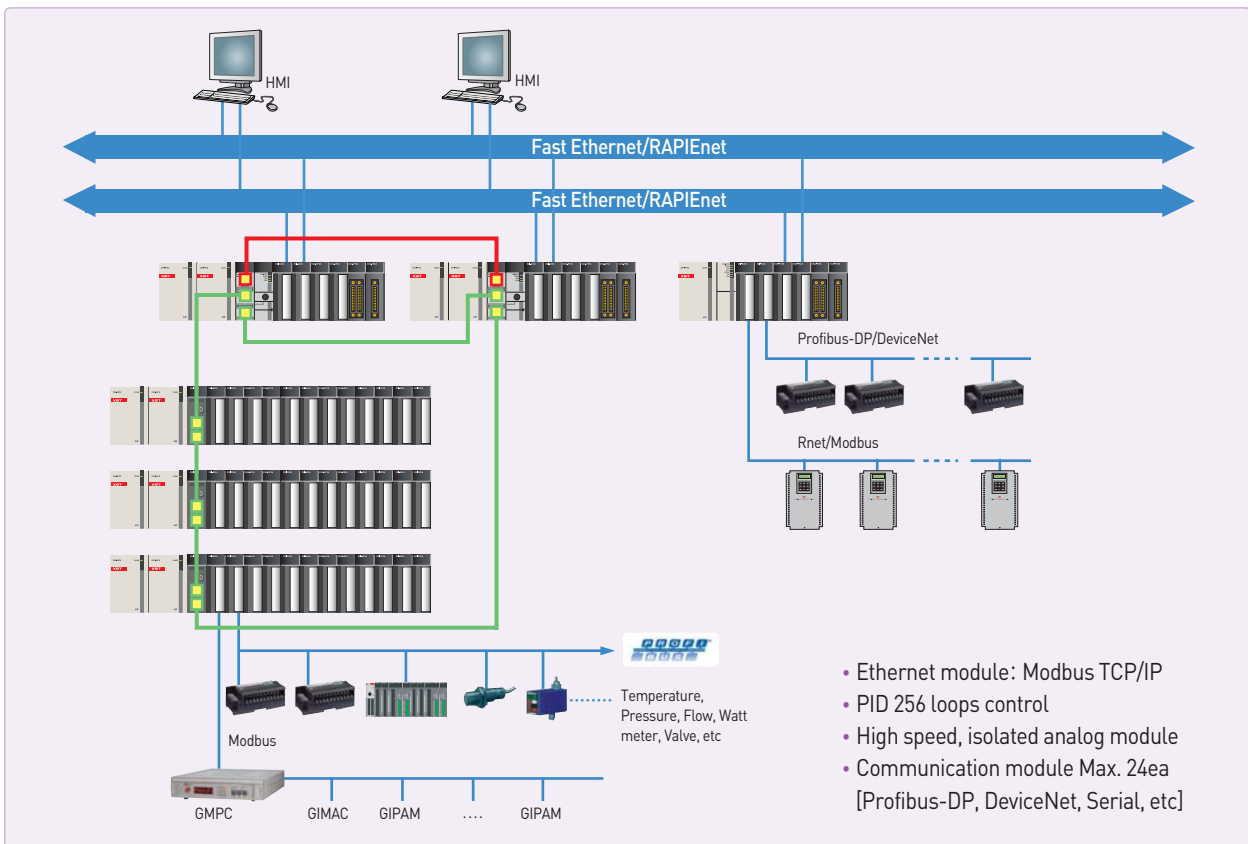

Broad casting system

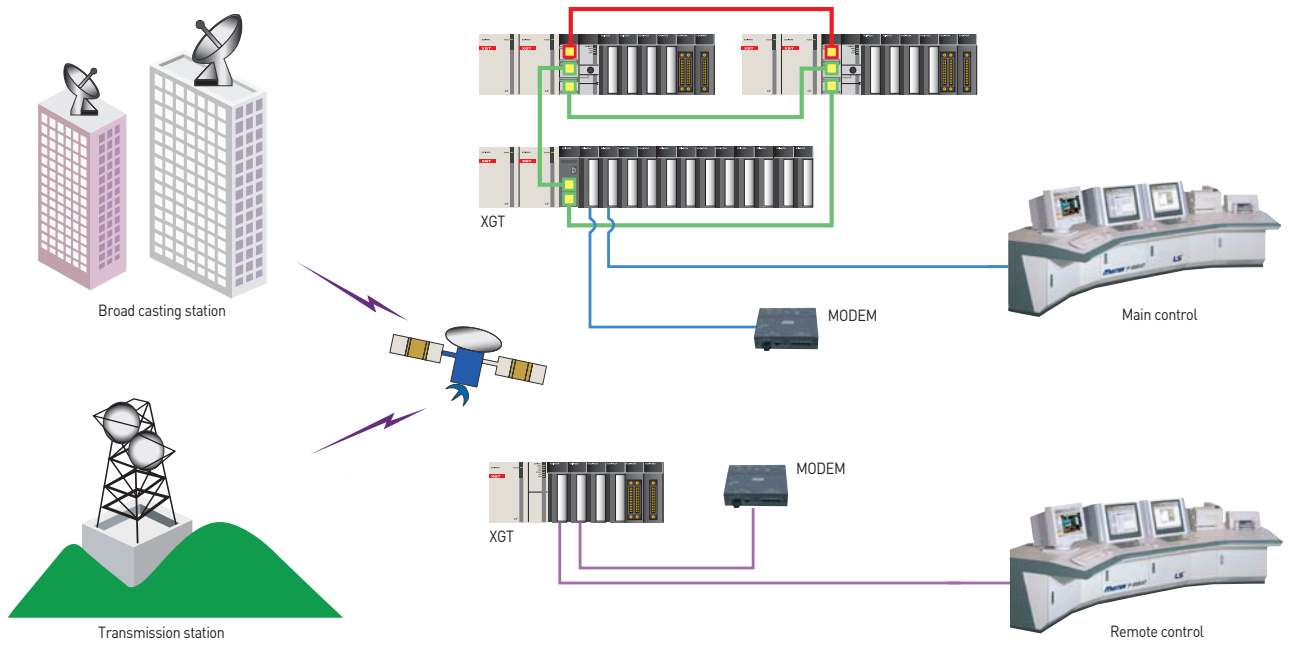

SYSTEM

System configuration

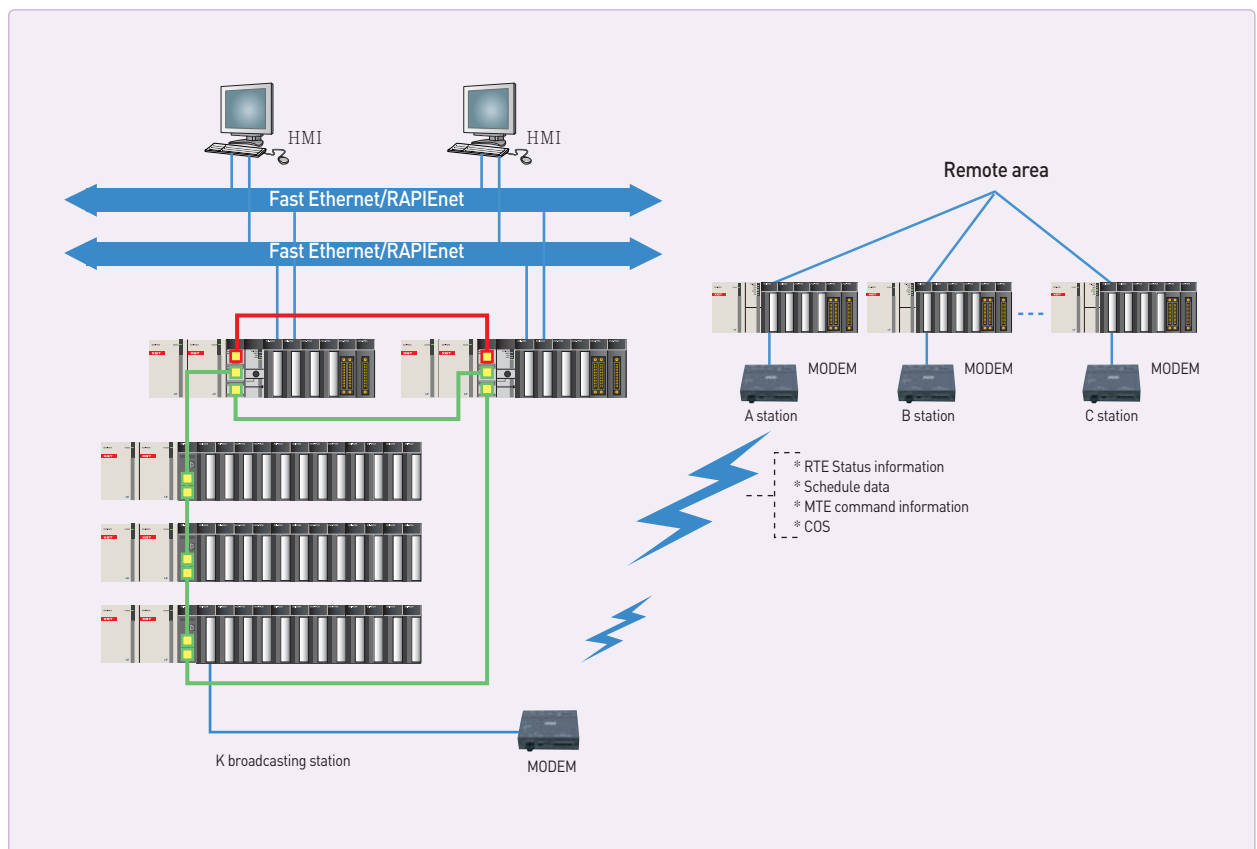





Network

Along with Ethernet, Profibus-DP, and DeviceNet, XGT series provide the maximum in control integration and communication flexibility.

Contents

46	XGT Network system	72	Fnet
48	RAPIDnet+	74	BACnet/IP
50	RAPIDnet+ System Configuration	76	Computer-Link
52	RAPIDnet+ Master(Client) module	88	Communication example (Ethernet)
54	RAPIDnet+ Expansion driver module	80	Communication example (Rnet)
56	RAPIDnet+ Smart I/O (Stand alone type)	82	Communication example (DeviceNet) [SyCon setting Profibus, DeviceNet]
58	RAPIDnet+ Smart I/O (Expandable type)	83	SMART I/O (Stand alone)
60	RAPIDnet+ Multiport RAPIDnet switch(MRS)	84	SMART I/O [Modbus/TCP, Ether Net/IP Adapter]
62	Computer-Link [Cnet]	86	SMART I/O [DeviceNet adapter]
64	DeviceNet [Dnet]	87	SMART I/O [Profibus-DP adapter]
66	Profibus-DP [Pnet] system	88	SMART I/O [Rnet adapter]
67	Profibus-DP[Pnet] Slave I/F system	89	SMART I/O [Features]
68	Profibus-DP [Pnet] Remote I/F system		
70	Rnet		

Features

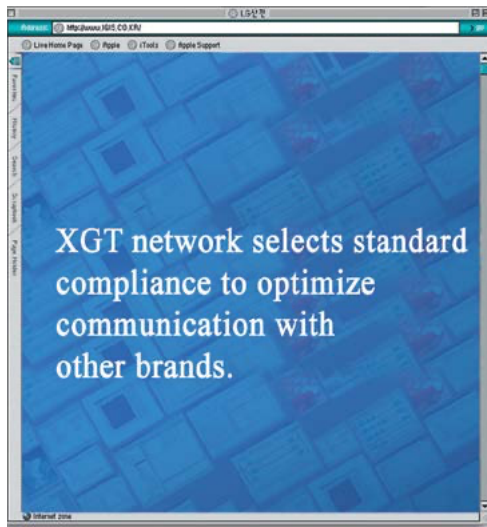

※CIM:Computer Integrated Manufacturing

About RAPIEnet⁺

Real-time, hybrid & ring topology-based industrial Ethernet solution, integrating Modbus TCP/IP, EtherNet/IP and RAPIEnet for IoT, future-oriented technology for high performance & efficiency.

RAPIEnet

- IEC standard (RAPIEnet) communication technology applied
- Dedicated network for LS PLC
- Communication speed: 100Mbps, 1Gbps
- Topology : Star, Line, Ring
- Dual port (T.Pair / F.Optic / Hybrid)
- Built-in high performance industrial switch
- Max read/write data size : 1,400 byte
- Max No. of connected stations per network : 64 stations

EtherNet/IP

- Topology : Star, Line
- Communication speed: 100Mbps, 1Gbps
- Dual port (T.Pair / F.Optic / Hybrid)
- Built-in high performance industrial switch
- Max read/write data size : 1,400 byte(Non-periodic tag)
- Max No. of connected stations per network : 64 stations

Modbus TCP/IP

- Topology : Star, Line
- Communication speed: 100Mbps, 1Gbps
- Dual port (T.Pair / F.Optic / Hybrid)
- Built-in high performance industrial switch
- Max read/write data size : 125/123 Word
- Max No. of connected stations per network : 64 stations

XGT dedicated

- Topology : Star, Line
- Communication speed: 100Mbps, 1Gbps
- Dual port (T.Pair / F.Optic / Hybrid)
- Built-in high performance industrial switch
- Max read/write data size : 1,400 byte
- Max No. of connected stations per network : 64 stations

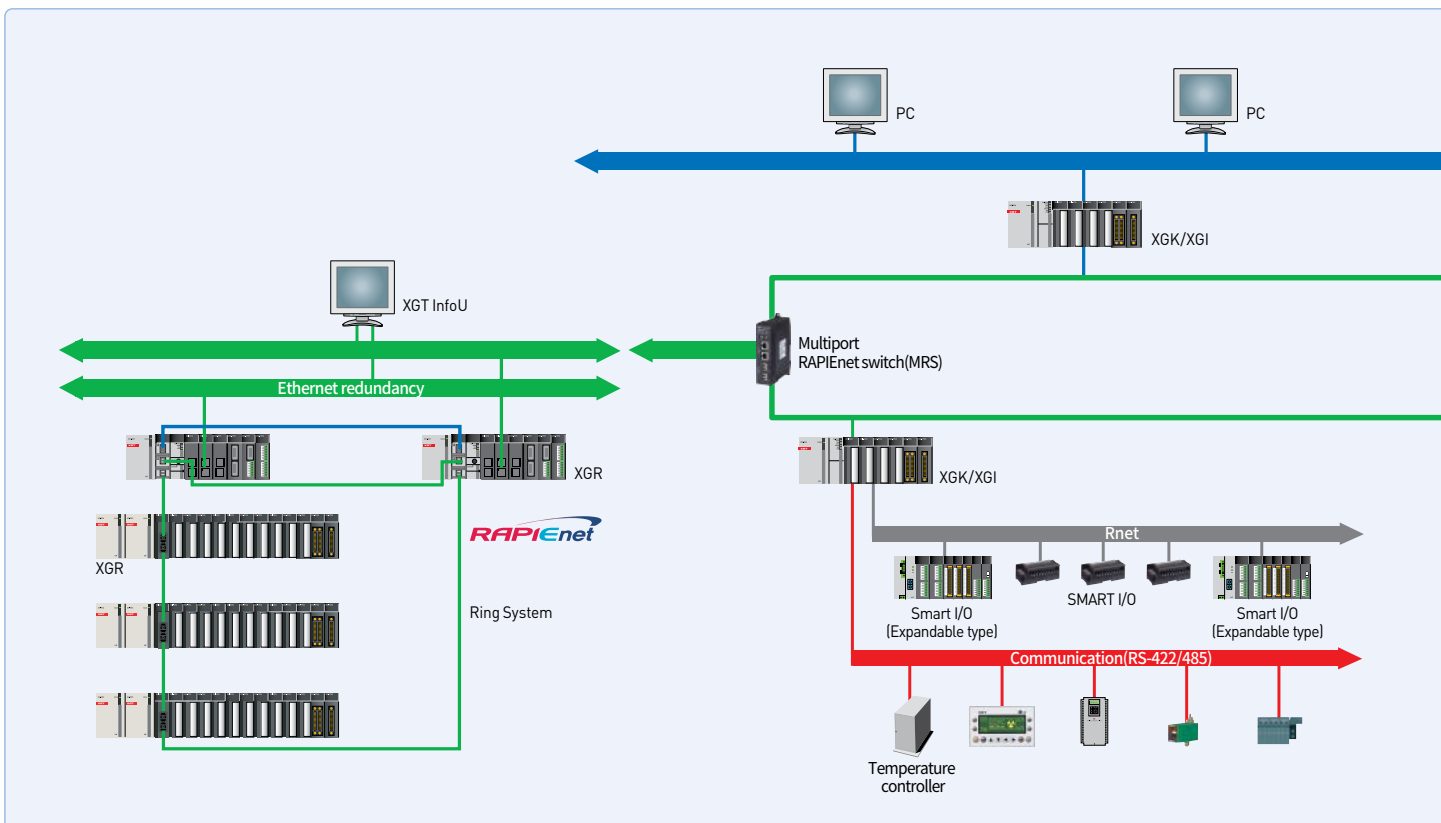

Computer Link(Cnet)

- RS-232C/485/422 communication
- Long-distance communication via modem connection
- Various connection to HMI S/W (XGT, Modbus RTU, Modbus ASCII)
- User-defined communication
- Convenient P2P master (XGT, Modbus)

Fnet

- Dedicated network for LS PLC
- Easy high-speed link parameter setup
- 1Mbps high-speed communication
- Max. 750m
- Max. 6ea repeater available (Max. expansion 5.25km)
- Network management through Auto scan

Rnet

- High-speed communication 1Mbps
- Long communication distance Max.750m
- Max. 6 repeaters (up to 5.25km)
- Network management using Auto-scan (Slave module information)

DeviceNet(Dnet)

- Connectable to other PLCs and control device
- Compliance of the ODVA standard
- Flexible communication speed setting: 125/250/500Kbps
- Multi-drop and T branch connection
- Long communication distance: Max. 500m

Profibus-DP(Pnet)

- Optimum communication for a master automation device and distributed slave I/O devices
- Fast slave communication omitting application layer
- Long communication distance: Max. 1200m
- Communication using High-speed link parameter

Installation number of network module available

Item	XGK / XGI / XGR CPU
Total network module	24
High-speed link module	12
P2P service	8

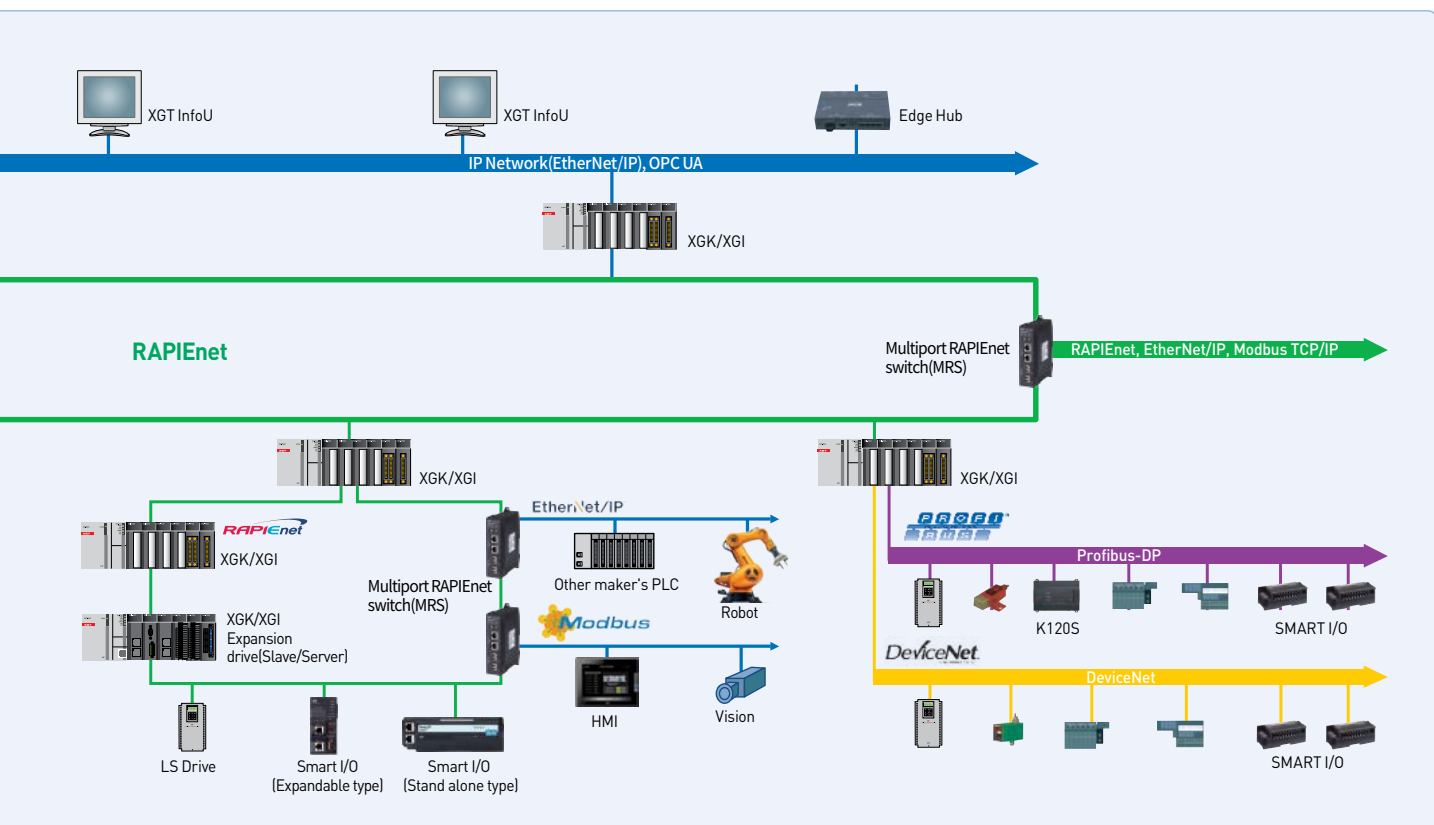

NETWORK

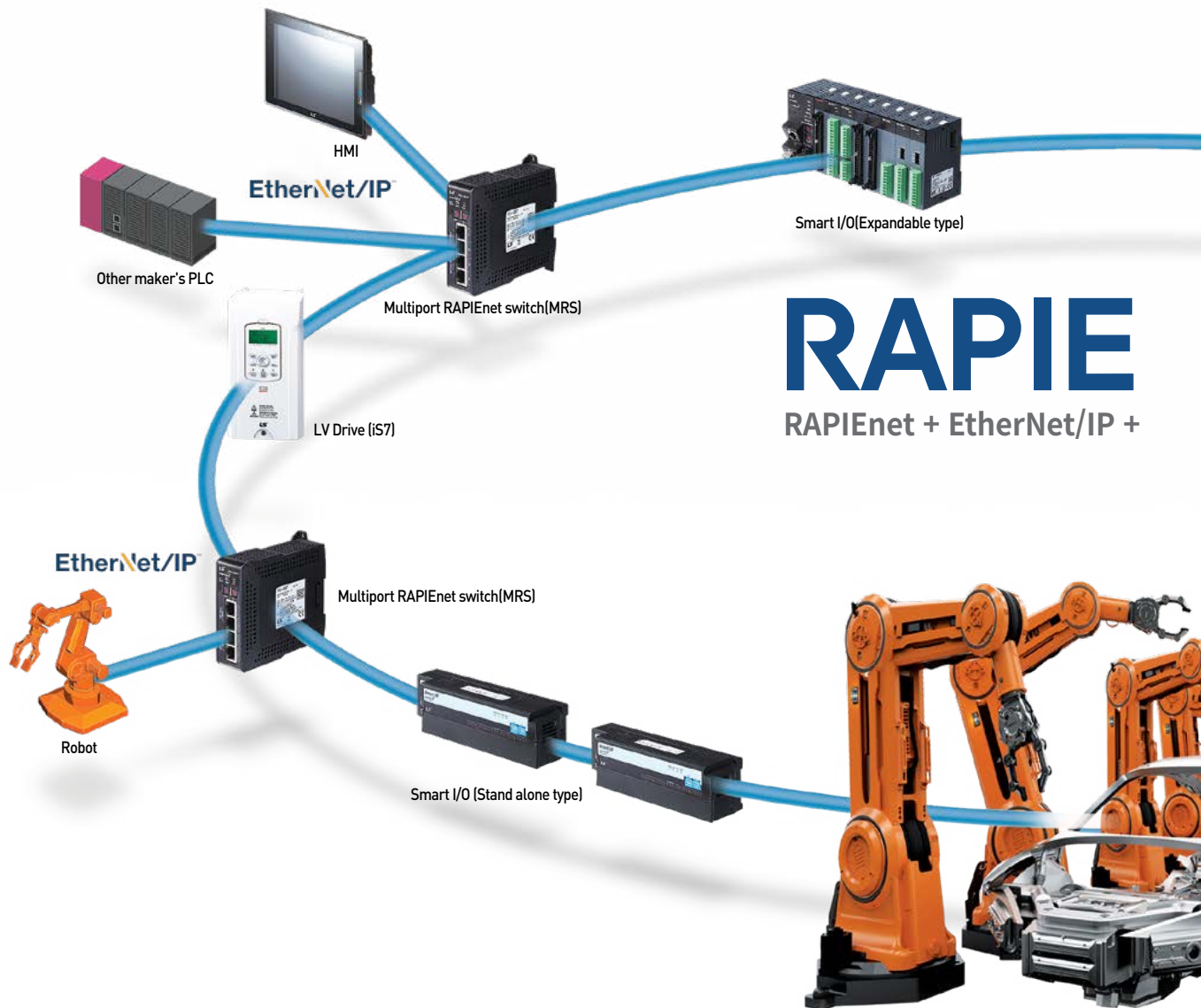

RAPINet

RAPINet + EtherNet/IP +

About RAPINet+

Real-time, hybrid & ring topology-based industrial Ethernet solution, integrating Modbus TCP/IP, EtherNet/IP and RAPINet for IoT and future-oriented technology for high performance & efficiency.



Professional

- Integrated hybrid network solution
- Three protocols in a single product: Modbus TCP/IP, EtherNet/IP, RAPINet
- Various and convenient network system configuration with smart extension service
- IEC standard (RAPINet) communication technology applied
- Gigabit Ethernet from 100Mbps to 1Gbps for large networks

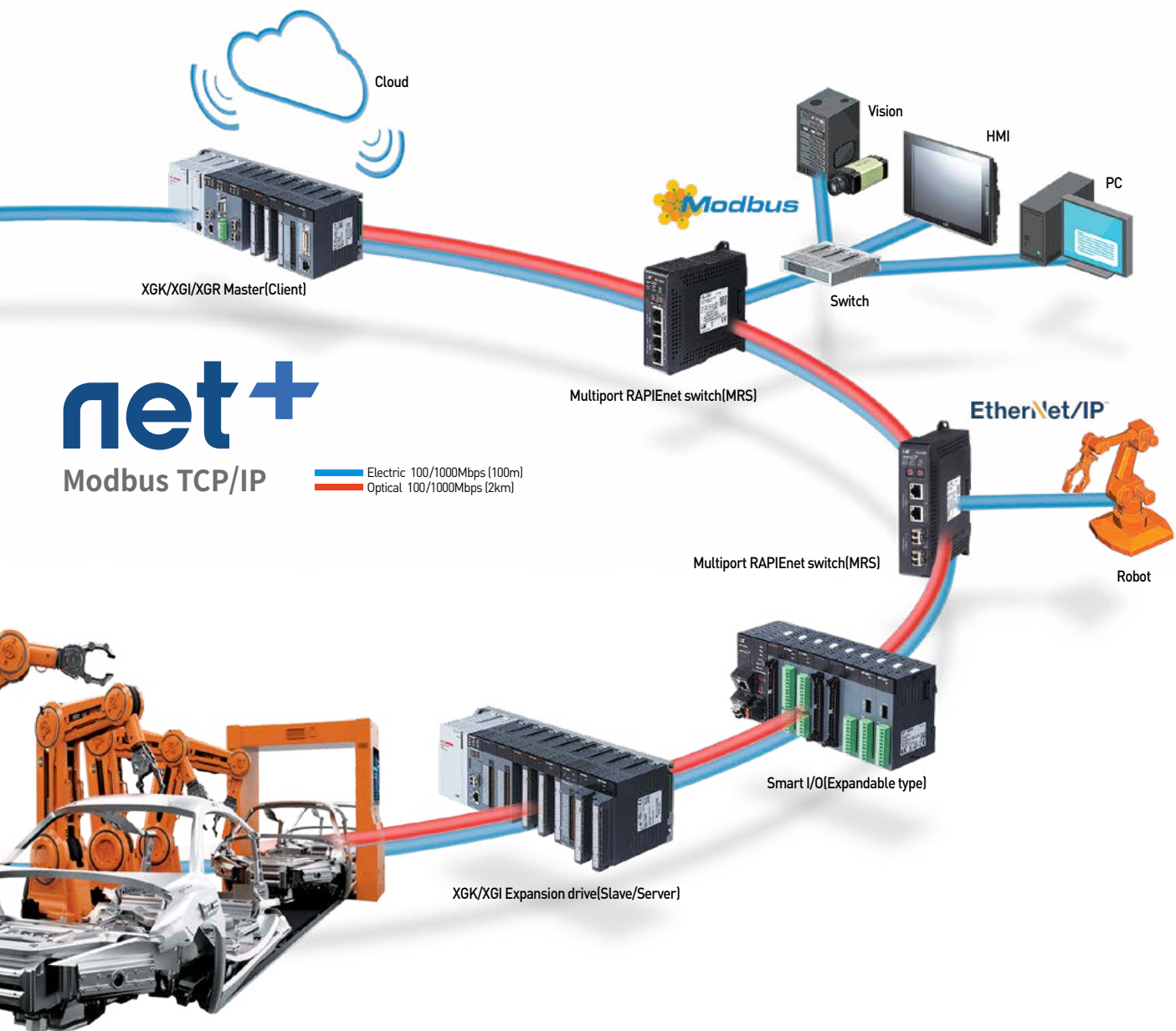

net+

Modbus TCP/IP

— Electric 100/1000Mbps (100m)
— Optical 100/1000Mbps (2km)

NETWORK



Efficiency

- Efficient network configuration with 2-port Ethernet
- Network cost reduction using electrical to fiber optic cable
- Optimized system configuration with automation products (PLC, remote I/O, Drive, etc.)
- Easy engineering via intuitive and user-friendly programming tool (XG5000)



Convenience

- Autoscan for network registration
- Min. parameter and programming setup
- Simple editing (add/change) for modules of operating system
- Variable maintenance available: service status, diagnosis, comm. history, etc.



Reliability

- Reliability improvement for ring topology network
- Various functions for network monitoring and diagnosis
- Noise reduction by fiber-optic network

Ring Type

- Ring topology and configuration with third-party devices: reliability & product/wiring reduction
- Hybrid network (electric/fiber-optic): system cost reductio

— Electric 100/1000Mbps (100m)
— Optical 100/1000Mbps (2km)

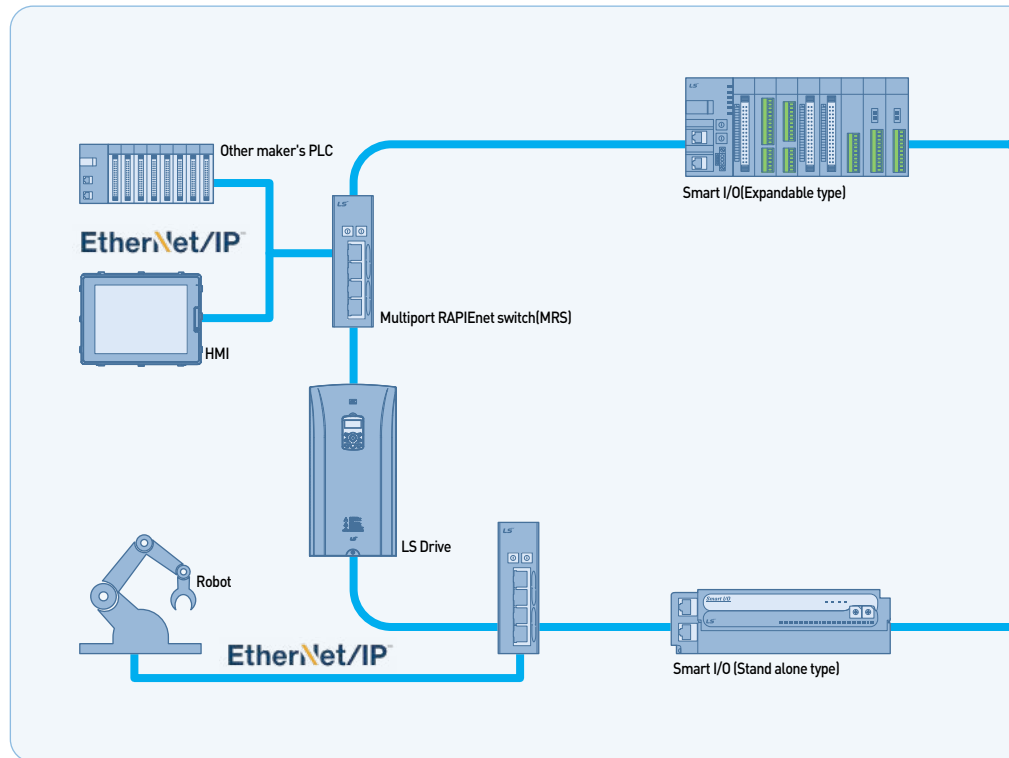

Daisy-chain Type

- Integrated network configuration with third-party devices
- EtherNet/IP and Modbus Hybrid communication: product/wiring reduction

— Electric 100/1000Mbps (100m)
— Optical 100/1000Mbps (2km)

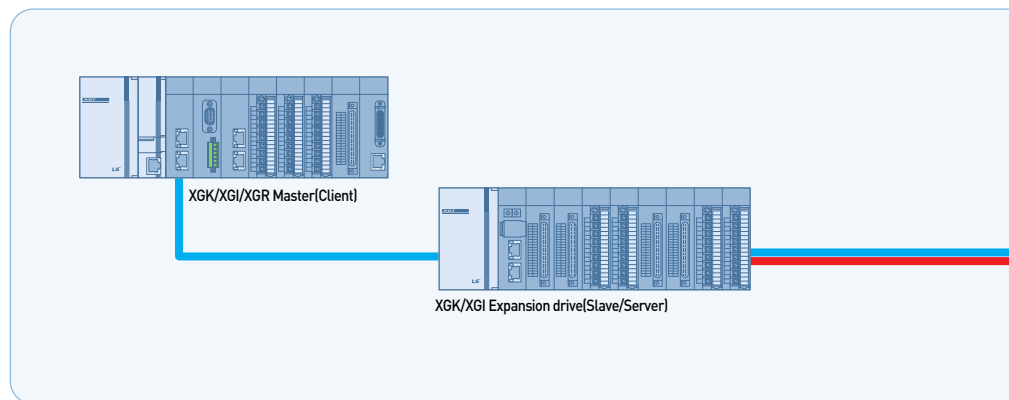

Star Type

- Integrated network configuration with third-party devices
- Varioud network configuration (general switch application available)

— Electric 100/1000Mbps (100m)

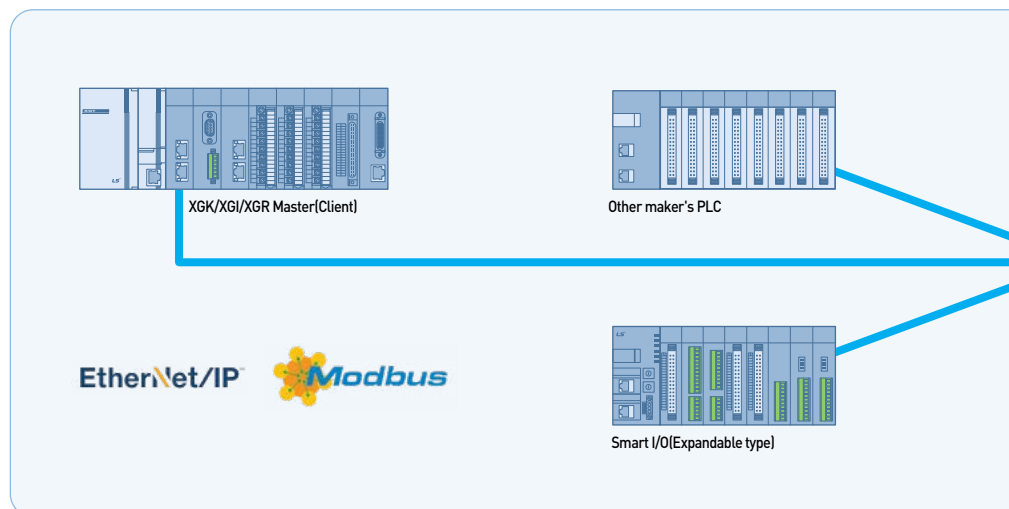

RAPIDnet+

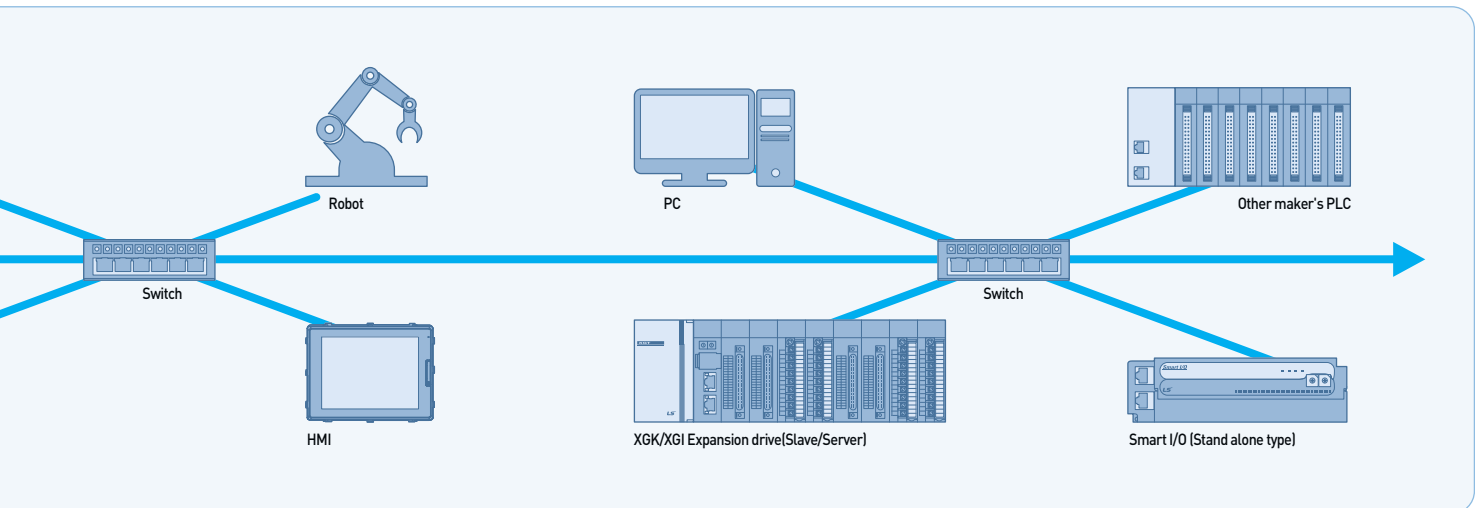
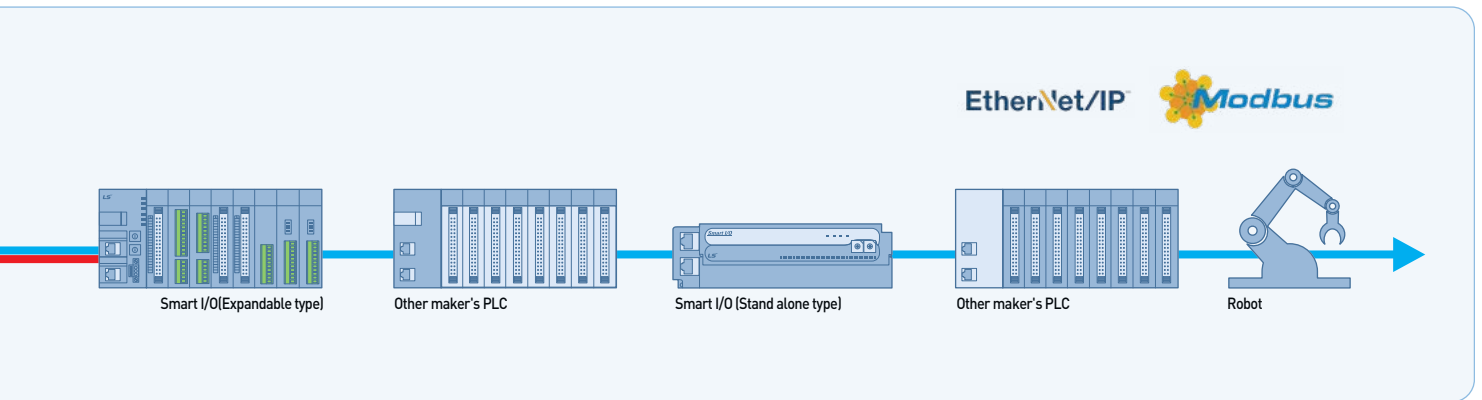
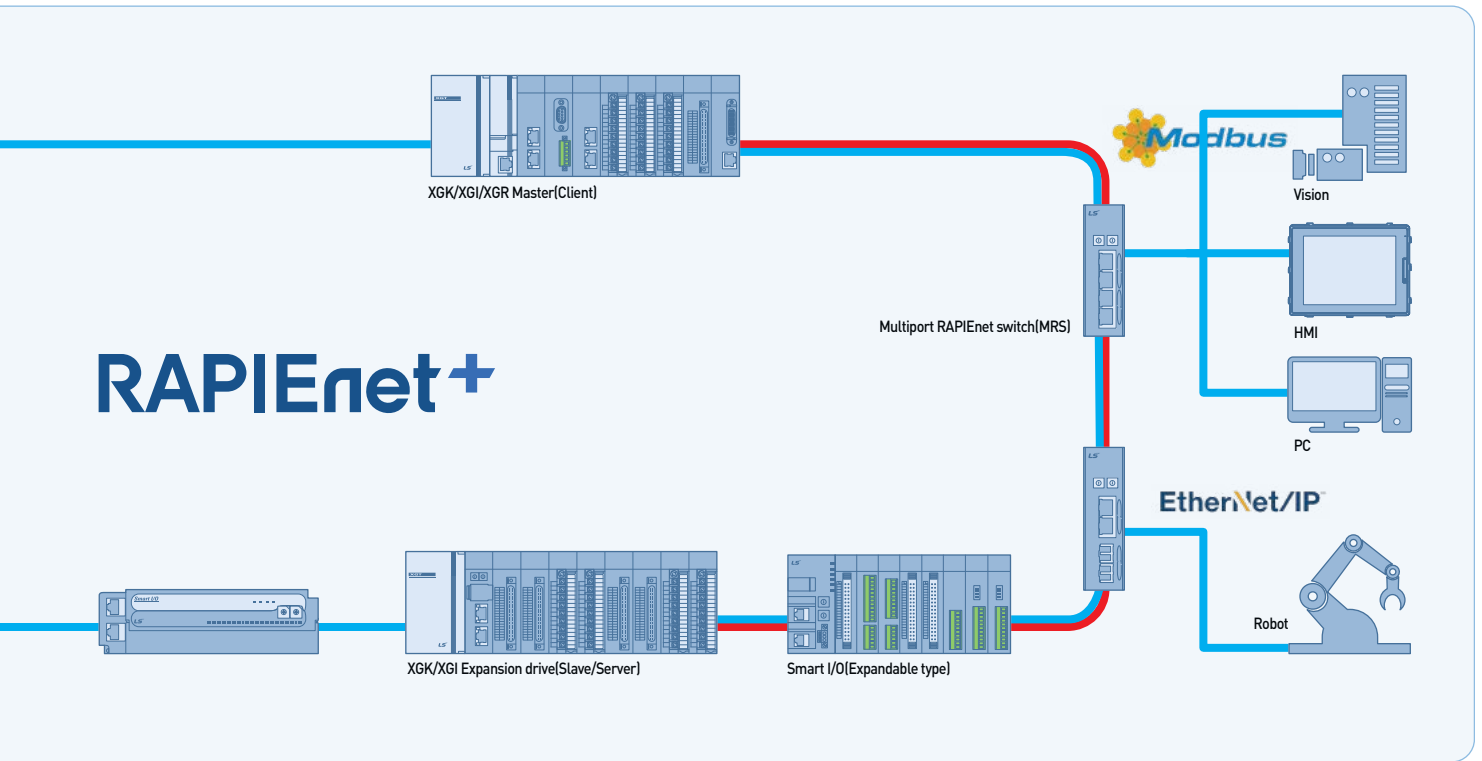

NETWORK

XGL-EFMTB, XGL-EFMFB, XGL-EFMHB

- Gigabit Ethernet (1Gbps)
- Two-port support
- Ring/Line topology configuration support:
no additional switch required
- Modbus TCP/IP, RAPIEnet (v6.0 or higher),
EtherNet/IP (v6.0 or higher) protocol support
- Max 5.000pps network load (based on server operation)
- Data processing speed: 1ms
- Various and convenient network system configuraion with
Smart Extension Service (v8.0 or higher)
- XG5000 network setup and programming (v4.30 or higher)
- User protocol editing and P2P service:
(network with third-party devices)
- Various diagnostic functions and module/
network status information
- Network module check function (Ping test)
- Network service information (HS link, P2P, media status, etc)
- OPC UA Server support (OPC UA Specification v1.03, XGL-EFMxB v7.0)
- OS replacement for OPC UA Server of XGL-EFMxB in XG5000 is required.
(Please refer to user's manual).



Specification

Item		XGL-EFMTB	XGL-EFMFB	XGL-EFMHB	
Transmission Specifications	Transmission speed (Mbps)	10/100/1000	100/1000	Electric: 10/100/1000 Optical: 100/1000	
	Transmission method	Baseband			
	Maximum distance between nodes	100m (Node-Switch)	2km (Multi-mode)	Electric: 100m Optical: 2km	
	Send media	Electric: Category 5E or higher STP (Shielded Twisted-pair) cable Optical: Multi mode(MMF)/Single mode(SMF) cable			
	Maximum protocol size	1,500 Byte			
	Communication network access method	CSMA/CD			
	Frame error check method	CRC32			
Max. load	Ethernet: 10,000pps, RAPIEnet: 40,000pps				
Topology	Line, Tree, Star, Ring (RAPIEnet Enable)				
Diagnosis function	Station number / IP collision detection function, Diagnosis using XG5000				
Station number / IP setting method	Rotary switch, XG5000, BOOTP/DHCP				
Station number / IP setting range	Station number setting value set by the tool(XG5000) (0 to 220) - IP: 192.168.1.xx(xx:100 + rotary switch 1~99)				
External connecting terminal	RJ45, SFP : PADT connection, data communication				
Basic Specific	Current consumption (mA)	100Mbps	560	750	670
		1Gbps	900	740	670
	Weight(g)	146	130	120	

Network service specification

	Item	XGL-EFMTB	XGL-EFMFB	XGL-EFMHB
RAPIEnet	Data processing unit	Byte(8bit)		
	Max read/write data size	1,400 byte		
	Max No. of connected stations per network	221 stations (However, 64 stations are used for the Smart extension service.)		
EtherNet/IP	Data processing unit	Byte(8bit)		
	Max read/write data size	Non-periodic tag: 1,400 Byte Non-periodic object : 1,024 Byte Cycle 1,024 Byte		
	Available communication type	Connection-type (Cycle) messages: Class1 Non connection type(Non-periodic) message: Tag, Object		
	Maximum number of connections	Connection-type (periodic)+ Non connection type(Non-periodic):64		
Modbus / TCP	Data processing unit	Word(16bit),bit		
	Max read data size	125 Word(2,000 Bits)		
	Max write data size	123 Word(1,968 Bits)		
	Maximum number of connections	64		
XGT dedicated	Data processing unit	Byte(8bit)		
	Max read/write data size	1,400 byte		
	Maximum number of connections	64		

Smart extension master

Smart extension service is network service between LS Automation products to enable users to extend several PLCs and drives without network parameter and programming, including EtherNet/IP client service.

Smart Extension Setup Wizard	Users could do network setup easily with 'Smart Extension Setup Wizard' in XG5000.
Smart Extension Autoscan	Autoscan execution of network & control setting during online.
Remote Device Setting	* Automatic execution of I/O and Basic Parameter Setting via XGL-EFMxB (master) * Hot swap setting for slave module replacement
Smart Extension Diagnosis Flag	Diagnostic information service for network devices and modules of Smart Extension system
Remote network	Device IP/Station No. change Remote network device IP and station no. change during online based on user setting (master)

XGL-DBDT, XGL-DBDF, XGL-DBDH

- Large PLC system configuration with XGL-DBDx(slave module) installation on CPU slot of XGK/XGK main base
 - PLC extension system configuration: 63-stage network extension (XGT base extension: 7 stage)
 - Extension distance: electric 100m, fiber-optic 2km (XGT base extension: 15m)
 - I/O point: Max. 49,152 (XGT base extension: 6,144)
- Modbus TCP/IP, RAPIEnet, EtherNet/IP protocol simultaneous support
- Electric/Fiber-optic/Hybrid module comm. speed: Max. 1Gbps
- 2-port (dual port) support
 - No additional switch required for ring/line topology configuration
- Hot swap for base replacement (add/delete available)
 - Base replacement without system in case of extension base error
- Ring-to-line: fast reconfiguration to line topology for a line fault of ring
- Extension base power redundancy (with XGR extension base)
- Diagnostic function for service status



Specification

Item		XGL-DBDT	XGL-DBDF	XGL-DBDH
Transmission Specifications	Transmission speed (Mbps)	100/1000	100/1000	Electric: 100/1000 Optical: 100/1000
	Transmission method	Base band		
	Maximum distance between nodes	100m@CAT5E or higher	2km@100Mbps.MM	Electric: 100m Optical: 2km
	Send media	Electric: Category 5E or higher STP (Shielded Twisted-pair) cable Optical: Multi mode(MMF)/Single mode(SMF) cable		
	Maximum protocol size	1,500Bytes		
	Communication network access method	CSMA/CD		
	Frame error check method	CRC32		
Max. load	Ethernet: 10,000pps, RAPIEnet: 40,000pps			
Topology	When using RAPIEnet : Lines, Ring (using MRS if you use a different topology) When not using RAPIEnet : Line, Tree, Star etc. (with switch)			
Diagnosis function	Station number/IP collision detection function, self-diagnosis service, diagnosis using XG5000			
Station number / IP setting method	Rotary switch, XG5000, BOOTP/DHCP			
Station number / IP setting range	Station number: Rotary switch(1 ~ 99) IP: 192.168.1.xx(xx:100 + rotary switch 1-99)			
External connecting terminal	USB mini B : PADT connection RJ45, SFP : PADT connection, data communication			
Status indication LED	PWR, RUN, SVR, I/F, RELAY, PADT, CHK, ERR, FAULT, LINK, ACT			
Parameter setting	XG5000(USB, Ethernet port)			
Device file	EDS file(Only EtherNet/IP)			
Maximum number of modules to be installed	12			

Network service specification

Item		XGL-DBDT	XGL-DBDF	XGL-DBDH
RAPIEnet	Data processing unit	Byte(8bit)		
	Max read data size	1,400 Byte		
	Max write data size	1,400 Byte		
	Max No. of connected stations per network	64 station		
EtherNet/IP	Data processing unit	Byte(8bit)		
	Max read data size	Non-periodic tag: 1,400 Byte / Non-periodic object: 1,024 Byte / Cycle: 1,024 Byte		
	Max write data size	Non-periodic tag: 1,400 Byte / Non-periodic object: 1,024 Byte / Cycle: 1,024 Byte		
	Available communication type	Connection-type (Cycle) messages: Class1 Non connection type(Non-periodic) message: Tag, Object		
	Maximum number of connections	Connection-type (Cycle):10 Non connection type(Non-periodic) message(Tag, Object):10		
Modbus TCP/IP	Data processing unit	Word(16bit),bit		
	Max read data size	125 Word(2,000 Bits)		
	Max write data size	123 Word(1,968 Bits)		
	Maximum number of connections	64		

Available Module

Item		I/O module	Item		I/O module
Digital	Input	XGI-D21A	Analog	Input	XGF-AD16A
		XGI-D22A/B			XGF-AC4H
		XGI-D24A/B			XGF-AW4S
		Output		XGI-D28A/B	XGF-DV4A
				XGI-A12A	XGF-DV8A
				XGI-A21A/C	XGF-DC4A
				XGI-D21D	XGF-DC8A
	XGQ-RY1A			XGF-DV4S	
	XGQ-RY2A/B			XGF-DC4S	
	XGQ-TR1C			XGF-DC4H	
	Input/Output	XGQ-TR2A/B		XGF-HO2A	
		XGQ-TR4A/B		XGF-HD2A	
		XGQ-TR8A/B		XGF-HO8A	
		XGQ-SS2A		XGF-RD4A	
XGQ-RY1D		XGF-RD4S			
XGH-DT4A		XGF-RD4S			
XGH-DT4A		XGF-TC4S			
Analog	Input	XGF-AV8A	High-speed counter	XGF-RD8A	
		XGF-AC8A		XGF-AH6A	
		XGF-AD4S		XGF-TC4UD	
		XGF-AD8A		XGF-TC4RT	
			RTD & thermocouple		
			Input/Output		
			Temperature controller		



GEL-D24C, GEL-DT4C1, GEL-TR4C1, GEL-RY2C, GEL-AV8C, GEL-AC8C, GEL-DV4C, GEL-DC4C

- Modbus TCP/IP, RAPIEnet, EtherNet/IP protocol support
- RJ45 connector
- Flexibility in network topology (ring, line)
 - Redundancy support in ring topology
- Simple module setting with station no. setup (No IP setup required)
- Easy & Simple parameter setup: Autoscan for module add, checkbox for parameter setup (No program required)
- High-speed data processing
- Cost reduction in wiring
- Various diagnostic service
 - Station no. collision error
 - Remote batch processing in O/S upgrade via master module
 - Network status check by CRC error flag
 - Enhanced Autoscan function: station collision, module information, etc.
 - Error flag: comm. error between master and Smart I/Os



Specification

Item		Content
Transmission Specifications	Transmission speed	PORT1/2: 100Mbps
	Transmission method	Base band
	Maximum distance between nodes	100m@CAT5E or higher
	Send media	Electric: Category 5E or higher STP (Shielded Twisted-pair) cable
	Maximum protocol size	1,500Bytes
	Communication network access method	CSMA/CD
	Frame error check method	CRC32
Max. load	Ethernet: 10,000pps, RAPIEnet: 40,000pps	
Topology	When using RAPIEnet : Lines, Ring (using MRS if you use a different topology) When not using RAPIEnet : Line, Tree, Star etc. (with switch)	
Diagnosis function	Station number / IP collision detection function, self-diagnosis service, diagnosis using XG5000	
Station number / IP setting method	Rotary switch, XG5000, BOOTP/DHCP	
Station number / IP setting range	Station number: Rotary switch(1 ~ 99) IP: 192.168.1.xx(xx:100 + rotary switch 1~99)	
Status indication LED	STATUS, PORT1, PORT2, LACTH(output Only)	
Parameter setting	XG5000(Ethernet)	
Device file	EDS file(Only EtherNet/IP)	
Protocol	RAPIEnet, EtherNet/IP, Modbus-TCP, BOOTP, DHCP(RAPIEnet, EtherNet/IP can be Smart extension with XGL-EFMxB)	
I/O Refresh size	Max inputs: refresh size	64 bytes
	Max outputs: refresh size	64 bytes

Network service specification

Item		Content
RAPIEnet	Data processing unit	Byte(8bit)
	Max read data size	1,400 byte
	Max write data size	1,400 byte
	Max No. of connected stations per network	64 station
EtherNet/IP	Data processing unit	Byte(8bit)
	Max read data size	Non-periodic tag: 1,400 Byte Non-periodic object : 1,024 Byte Cycle: 1,024 Byte
	Max write data size	Non-periodic tag: 1,400 Byte Non-periodic object : 1,024 Byte Cycle: 1,024 Byte
	Available communication type	Connection-type (Cycle) messages: Class1 Non connection type(Non-periodic) message: Tag, Object
Maximum number of connections	Connection-type (Cycle) :10 Non connection type(Non-periodic) message(Tag, Object):10	
Modbus TCP/IP	Data processing unit	Word(16bit),bit
	Max read data size	125 Word(2,000 Bits)
	Max write data size	123 Word(1,968 Bits)
	Maximum number of connections	64

Input/output specification

Item		GEL-D24C	GEL-DT4C1	GEL-TR4C1	GEL-RY2C	
Digital I/O	Points	32(Input)	16/16(In/Out)	32(Output)	16(Output)	
	Rated input current	5mA		-	-	
	Rated load voltage	-	DC24V		DC24V/AC220V, 2A/point, 5A/COM	
	Max. load current	-	0.5A/point, 3A/COM		AC250V, DC110V, 1,200times/hour	
	On voltage	DC 19V or higher		-	Min. switching load : DC 5V/1mA	
	Off voltage	DC 6V or less		-		
	Insulation method	Photo coupler insulation				
Item		GEL-AV8C	GEL-AC8C	GEL-DV4C	GEL-DC4C	
Analog I/O	Channels	8		4		
	Input/output type	Voltage	Current	Voltage	Current	
	Input/output range	1 ~ 5V	4 ~ 20mA		1 ~ 5V	4 ~ 20mA 0 ~ 20mA
		0 ~ 5V	0 ~ 20mA		0 ~ 5V	
		0 ~ 10V			0 ~ 10V	
		-10 ~ 10V			-10 ~ 10V	
	Accuracy	0.3% (ambient air temperature 0 ~ 55℃)				
Max. resolution	1/16,000					
Max. conversion rate	10ms / channels					
Insulation method	insulation between input / output terminal and PLC power (no insulation between channels)					

XEL-BSSRT, XEL-BSSRF, XEL-BSSRH

- Slave PLC system configuration: XEL-BSSRx (extension Smart I/O adaptor) with XGB I/Os (DI/DO/AI/AO)
 - No. of XGB extension I/O: 8
- Modbus TCP/IP, RAPINet, EtherNet/IP protocol support
- Electric/Fiber-optic/Hybrid module comm. speed: Max. 1Gbps
- 2-port (dual port) support
 - No additional switch required for ring/line topology configuration
- Ring-to-line: fast reconfiguration to line topology for a line fault of ring
- Diagnostic function for service status



Specification

Item		XEL-BSSRT	XEL-BSSRF	XEL-BSSRH
Transmission Specifications	Transmission speed (Mbps)	100/1000	100/1000	Electric: 100/1000 Optical: 100/1000
	Transmission method	DDDD		
	Maximum distance between nodes	100m@CAT5E or higher	2km@100Mbps.MM	Electric: 100m Optical: 2km
	Send media	Electric: Category 5E or higher STP (Shielded Twisted-pair) cable Optical: Multi mode(MMF)/Single mode(SMF) cable		
	Maximum protocol size	1,500Bytes		
	Communication network access method	CSMA/CD		
	Frame error check method	CRC32		
Max. load	Ethernet: 10,000pps, RAPINet: 40,000pps			
Topology	When using RAPINet : Lines, Ring (using MRS if you use a different topology) When not using RAPINet : Line, Tree, Star etc. (with switch)			
Diagnosis function	Station number / IP collision detection function, self-diagnosis service, diagnosis using XG5000			
Station number / IP setting method	Rotary switch, XG5000, BOOTP/DHCP			
Station number / IP setting range	Station number: Rotary switch(1 ~ 99) IP: 192.168.1.xx(xx:100 + rotary switch 1~99)			
External connecting terminal	USB mini B : PADT connection RJ45, SFP : PADT connection, data communication 3pin Push in/Screw fixed type connector : power Input			
Status indication LED	RUN, RMS, RNS, RELAY, LINK/ACT1, LINK/ACT2 6 types			
Parameter setting	XG5000(USB, Ethernet)			
Device file	EDS file(Only EtherNet/IP)			
Maximum number of modules to be installed	8ea			
Protocol	RAPINet, EtherNet/IP, Modbus-TCP, BOOTP, DHCP (RAPINet, EtherNet / IP can be Smart extension with XGL-EFMxB)			

Network service specification

Item		XEL-BSSRT	XEL-BSSRF	XEL-BSSRH
RAPIEnet	Data processing unit	Byte(8bit)		
	Max read data size	1,400 Byte		
	Max write data size	1,400 Byte		
	Max No. of connected stations per network	64 station		
EtherNet/IP	Data processing unit	Byte(8bit)		
	Max read data size	Non-periodic tag: 1,400 Byte / Non-periodic object : 1,024 Byte / Cycle: 1,024 Byte		
	Max write data size	Non-periodic tag: 1,400 Byte / Non-periodic object : 1,024 Byte / Cycle: 1,024 Byte		
	Available communication type	Connection-type (Cycle) messages: Class1 Non connection type(Non-periodic) message: Tag, Object		
	Maximum number of connections	Connection-type (Cycle): 10 Non connection type(Non-periodic) message(Tag, Object): 10		
Modbus TCP/IP	Data processing unit	Word(16bit),bit		
	Max read data size	125 Word(2,000 Bits)		
	Max write data size	123 Word(1,968 Bits)		
	Maximum number of connections	64		

Available XGB I/O Module

Item		Module
Digital	Input	XBE-DC08A
		XBE-DC16A/B
		XBE-DC32A
	Output	XBE-AC08A
		XBE-TN/TP08A
		XBE-TN/TP16A
		XBE-TN/TP32A
		XBE-RY08A/B
		XBE-RY16A
		XBE-RY32A
Input/output	XBE-DR16A	
	XBE-DN32A	

Item		Module
Analog	Output	XBF-DV04A
		XBF-DC04A
		XBF-DC04B
		XBF-DV04C
		XBF-DC04C
		XBF-DC04D
	Input/output	XBF-AH04A
	RTD	XBF-RD04A
		XBF-RD01A
	TC	XBF-TC04B
		XBF-TC04S
	Load cell	XBF-LD02S
	High-speed counter	XBF-H002A
XBF-HD02A		

NETWORK

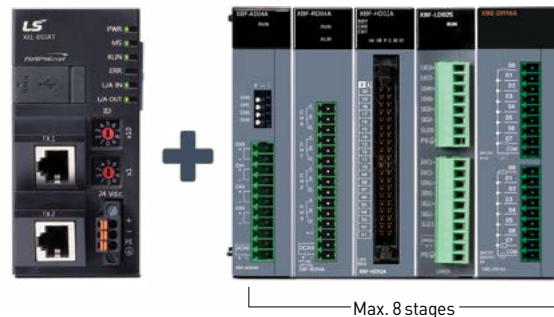

XOL-ES4T, XOL-ES4H

- Multi-port switch to integrate RAPIEnet, Modbus TCP/IP and EtherNet/IP network
- Max. 64 stations including master module
- Simple module setup with station no.: no additional S/W required.
- Module status information in XG5000 (Autoscan)
- Available from RAPIEnet v2.0 or later.



Various system methods can be configured by using MRS

2 Ring System (Ring to Ring)

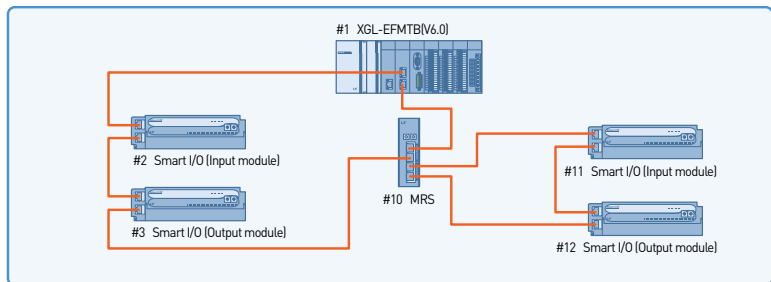

1 Ring / 1 Line System (Ring to Line)

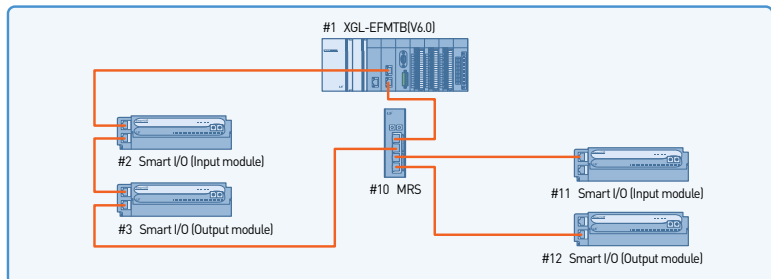

2 Line System (Line to Line)

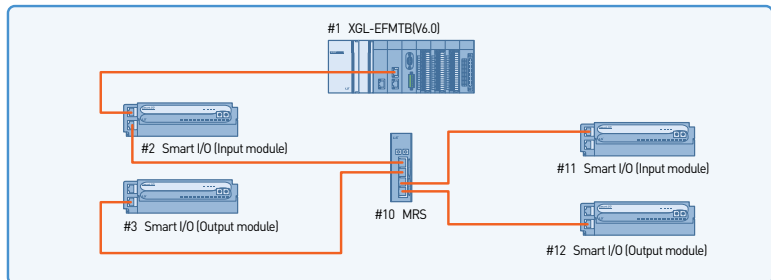

1 Line / 1 Ring System (Line to Ring)

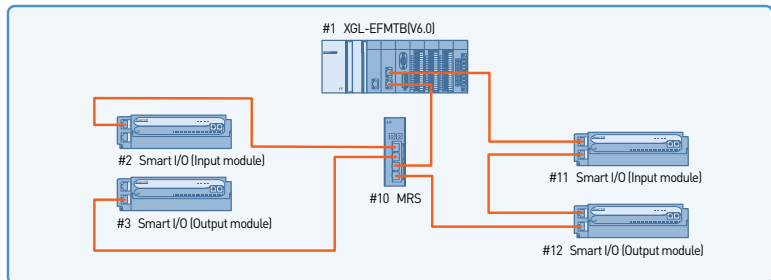

Specification

Item		RAPIEnet	
		XOL-ES4T	XOL-ES4H
Transmission Specifications	Transmission speed	100Mbps(1,2 port) 100Mbps/1 Gbps (3,4 port)	100Mbps/1 Gbps (1,2 port, electric) 100Mbps/1 Gbps (3,4 port,optical)
	Port type and number of ports	RJ45 4Ports	RJ45 2Ports, LC 2Ports
	Transmission distance	100m	100m/2km
	Diagnosis function	LED display	LED display
Basic Specifications	Power supply(DC)	24V(Input range:20.4~28.8V)	
	Current consumption(mA)	300	300
	Weight(g)	200	280

Various system methods can be configured by using MRS (Ethernet compatibility)

RAPIEnet(1,2 Port), Ethernet(3,4 Port)

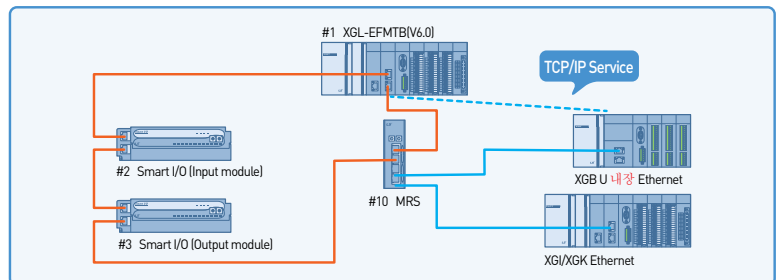

Ethernet(1,2 Port), RAPIEnet(3,4 Port)

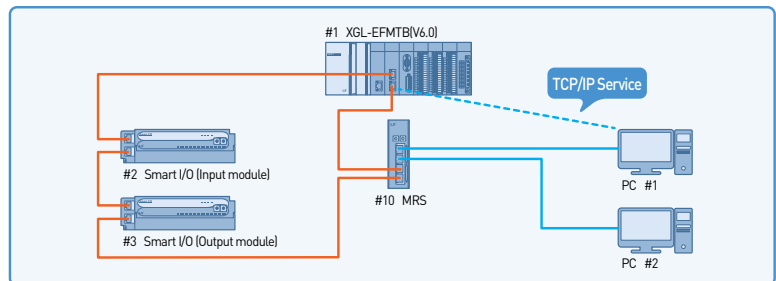

Ethernet, RAPIEnet(1,2 Port),
Ethernet(3,4 Port)

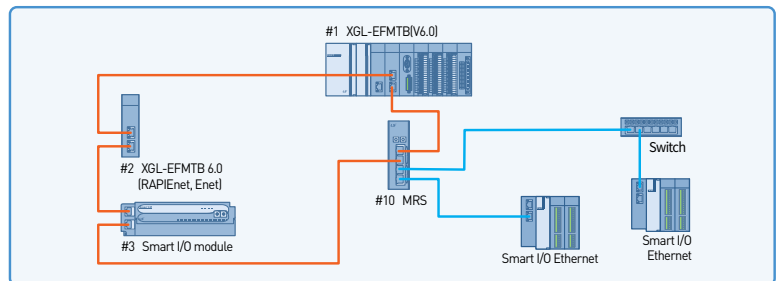

RAPIEnet, Ethernet(1,2 Port),
RAPIEnet, Ethernet(3,4 Port)

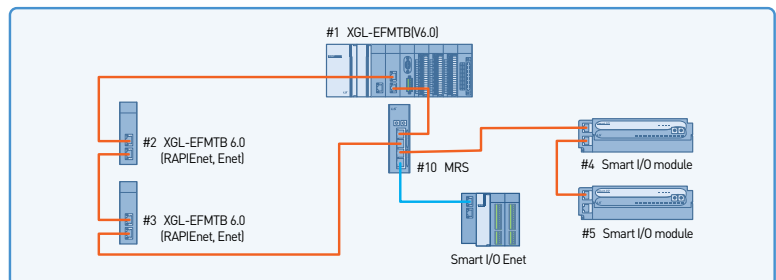

XGL-C22B, XGL-CH2B, XGL-C42B

- Smart server recognizes the protocol (XGT dedicated communication or Modbus RTU/ASCII) automatically and operates.
- Repeater mode is able to use as an insulated repeater or convert RS-232C to RS422/485.
- Contains built- in termination resistor and it can be set in the basic parameter window.
- Easy protocol editing and communication parameter setting: XG5000
- Long-distance communication via modem connection
- Dedicated protocol for multi-drop configuration connectable up to 32 units
- RS-232C/422 communication port
- Flexible communication speed setting (300~115,200bps)
- Supporting full duplex and half duplex communication
- Max. 12 modules available in one CPU
- P2P service: User-defined communication and XGT/ Modbus master
- Various connection to MMI S/W (XGT, Modbus RTU, Modbus ASCII)
- Various diagnosis functions using XG5000 (I/O, link status, service status)
- Communication service information (Dedicated service, P2P service)
- Supporting simultaneously dedicated service in remote connection
- Communication without additional setting when replacing communication module



Various independent operation mode

- Operation mode
- Dedicated protocol mode (Simultaneous support)
- Program upload/download by XG5000 protocol (RS-232C) Communication using LS ELECTRICdedicated protocol
- User-defined communication of P2P mode and XGT/Modbus master

Communication via RS-232C/422

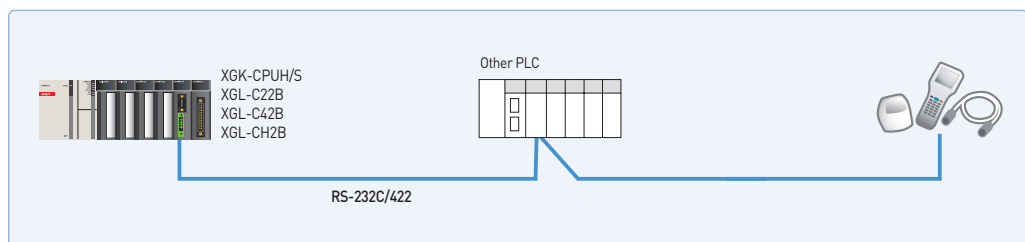

1: N and N: M connection (LS ELECTRIC and other)

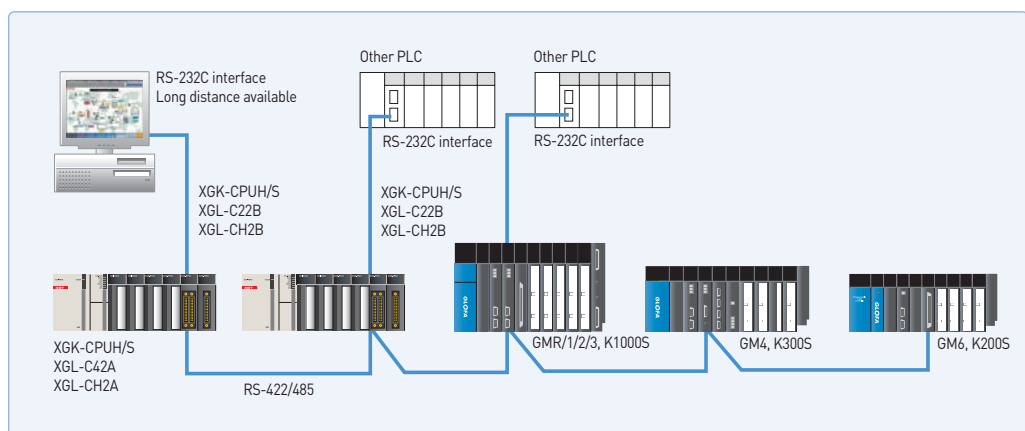

Specifications

Item		Specification		
		XGL-C22B	XGL-CH2B	XGL-C42B
Serial communication channel	RS-232C	2 channels	1 channel	-
	Line config	Conforms to RS-232C standard		
	RS-422/485	-	1 channel	2 channels
	Line config	Conforms to RS-422/485 standards		1:1, 1:n, n:1
Modem connection function		Remote communication with external devices is available via public telephone line by connecting external modem to the module.		-
Operating mode (specified per port)	P2P	XGT client, Modbus ASCII/RTU client, Use defined communication		
	SERVER	XGT server, Modbus ASCII/RTU server		
Data type	Start Bit	1		
	Data Bit	7 or 8		
	Stop Bit	1 or 2		
	Parity	Even/Odd/None		
Synchronization type		Asynchronous type		
Detecting error		BYTE SUM, WORD SUM, BYTE XOR, DLE AB, DLE SIEMENS, LS ELECTRICCRC, CRC 16, BYTE SUM 2' COMP, BYTE SUM 1's COMP 7BIT SUM, 7BIT XOR, CRC 16 IBM, CRC 16 CCITT		
Transmission speed (bps)		300/600/1,200 / 1,800 / 2,400 / 3,600 / 4,800 / 7,200 / 9,600/19,200 / 38,400 / 57,600 / 64,000 / 76,800 / 115,200 bps		
Station No. setting		Setting range : 0-31, Max. station No. : 32 stations		
Transmission Distance(m)		RS-232C: Max.15 [extendible if modem used]		-
		-	RS-422/485: Max. 1,200m	
Diagnosis function		Status LED diagnosis XG5000 diagnosis service(Frame monitor, Status by service, Loop-Back diagnosis) History, Saving history		
Appearance size(mm)		98(H) X 27(W) X 90(D)		
Current consumption(mA)		420	480	520
Weight(g)		121	119	116

* XGL-CH2A / C42A and XGL-CH2B / C42B differ from RS-422 / 485 communication connector wiring, you refer to the operation manual.

Modbus

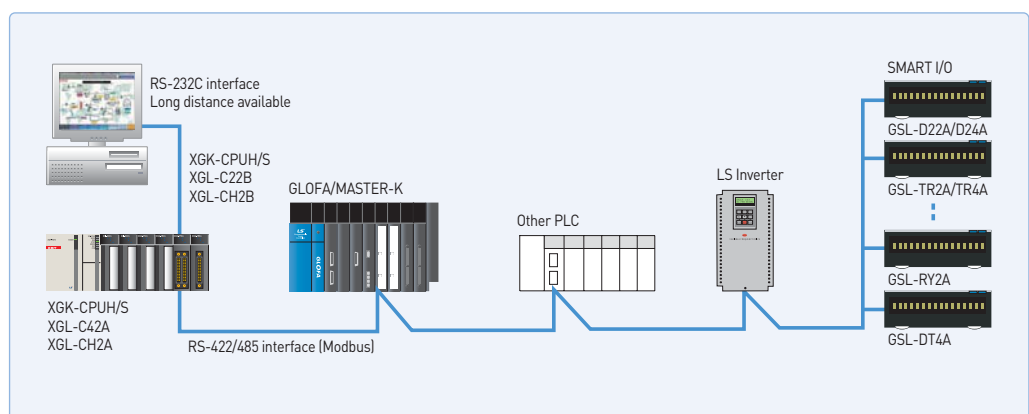

Cnet cable connection

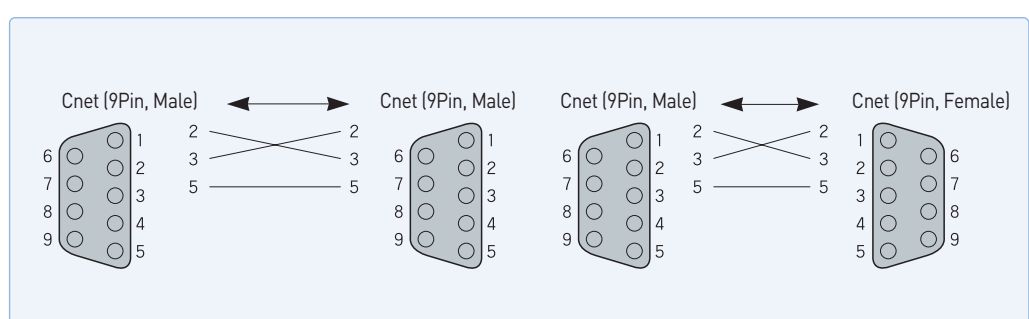

NETWORK

XGL-DMEB, XGL-DSEB



- DeviceNet protocol
- Direct control of various I/O devices via Dnet system
- Max. 63 slave modules controlled by one master module
- Flexibility in network configuration: Multi-drop and T branch connection
- Connectable to other master module and various slave modules
- Providing 'Auto Network Scan' function and various information with configuration tool (N Configurator)
- Communication using High-speed link parameter
- Connectable to various slave I/O including other module
[Common I/O, Actuator, Switch, Optical switch, Valve, Inverter, A/D module, Position controller etc.]
- Automatic monitoring of slave modules in the network: Auto-scan (XG5000)
- Easy expansion: up to 12 master modules
- Network setting by N Configurator/XG5000(Parameter setting, diagnosis and monitoring)

System configuration with LS ELECTRIC products

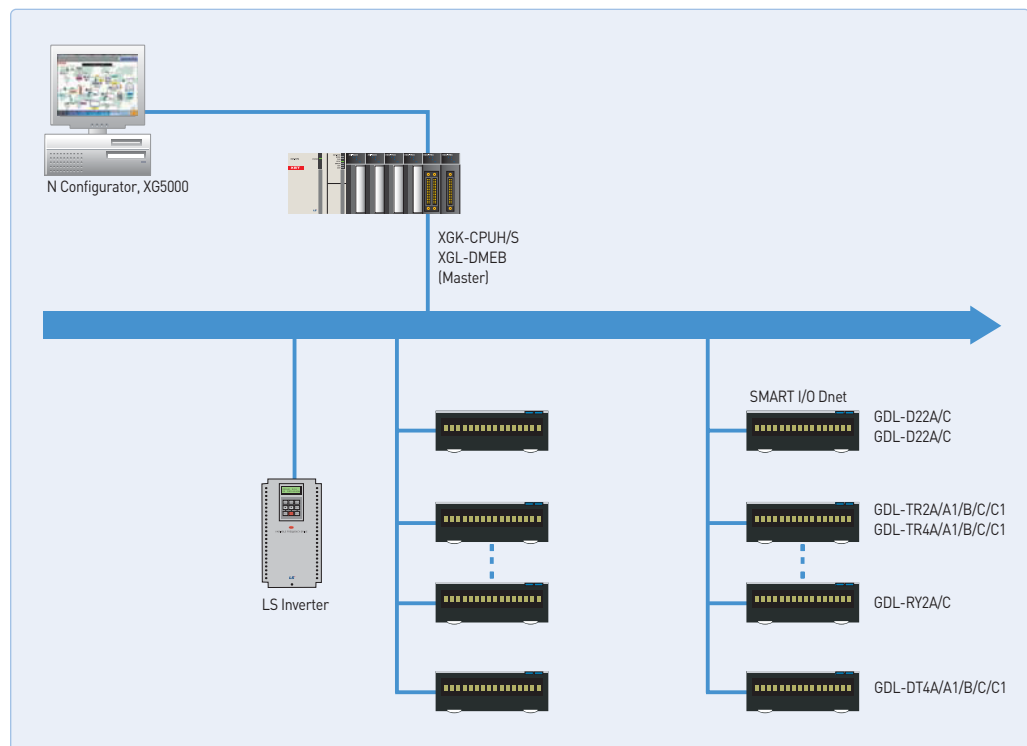

Specifications

Item		Performance Specifications	
Transmission Specification	Transmission Speed (kbps)	125/250/500	
	Transmission Type	I/O Connection	G2, UCMM
		I/O Communication	<ul style="list-style-type: none"> • XGL-DMEB: Poll, Bit strobe, COS, Cyclic • XGL-DSEB: Poll, COS, Cyclic
	Communication distance(m)	Thick Cable	500 (125kbps)/250 (250kbps)/100 (500kbps)
		Thin Cable	100 (125/250/500kbps)
	Terminal resistance (W)	121 (1%, 1/4W)	
	Max.drop length(m)	125 kbps	6 (Max. extended length 156)
		250 kbps	6 (Max. extended length 78)
		500 kbps	6 (Max. extended length 39)
	Data Packet	0-8 Bytes	
	Message Access Control	CSMA/NBA	
	Network Structure	<ul style="list-style-type: none"> • Trunk/drop line • Power/Signal cable inside the identical network cable 	
	Max. number of nodes	Up to 64 (including master) MAC IDs (MAC Identifier)	
	System Features	Insertion and removal of node available in voltage On status	
Operation Voltage	DC 24V		
Diagnosis Function	Module: Checks duplicated station/ Checks CRC error N Configurator: Detects defective station/Checks BusOff/Auto-scan function XG5000: Monitors High-speed link		
Master/Slave Operation	<ul style="list-style-type: none"> • XGL-DMEB: Available only in master • XGL-DSEB: Available only in slave 		
Parameter setting		<ul style="list-style-type: none"> • N Configurator (CONFIG Port of Dnet I/F) • Setting to High-speed link of XG5000 • Station number, baudrate setting by H/W switch(XGL-DSEB) 	
XG5000 (High-speed link)	Data process unit	Byte	
	Send/Receive period	Select among 10, 20ms, 50ms, 100ms, 200ms, 500ms, 1s, 5s, 10s - Default : 20ms	
	Max. communication point	<ul style="list-style-type: none"> • XGL-DMEB: Send 128,520 points, Receive 128,520 points, 16,065 bytes respectively • XGL-DSEB: Send 2,040 points, Receive 2,040 points, 255 bytes respectively 	
	Max. block number	64 (Setting range: 0-63)	
	Max. point number per block	2,040 points (255 bytes)	
Basic Specification	Max. modules installed	Up to 12 (available on basic base and added base)	
	Internal-consumed current (mA)	350mA	
	Weight (g)	81g	

NETWORK

System configuration with other products

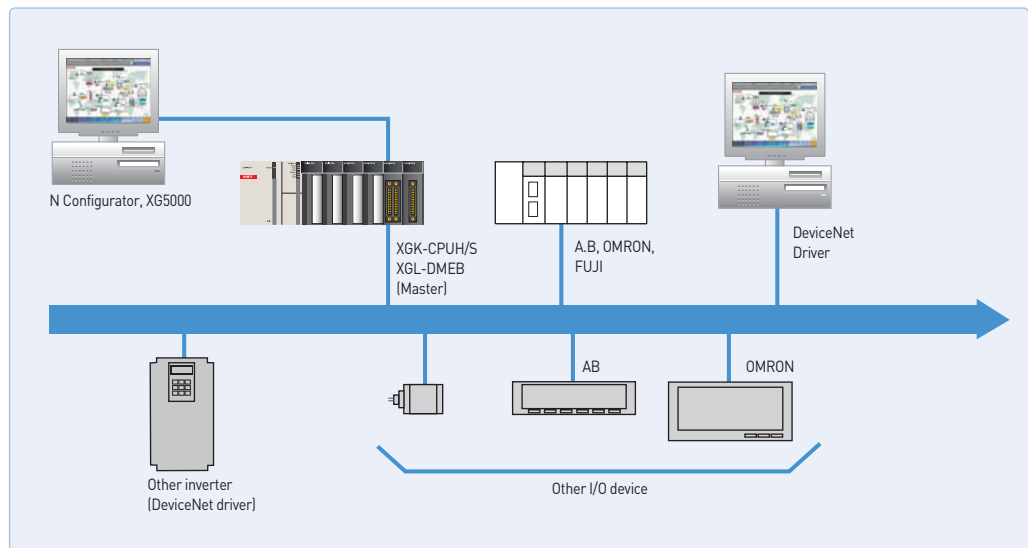

XGL-PMEB

- Profibus-DP protocol
- Proper to communicate among a master automation device and distributed slave I/O devices.
- Fast slave communication without application layer
- Transmission speed: 9.6Kbps ~ 12Mbps
- Transmission distance: Max. 1,200m
- Max. 126 slave stations available (32 stations per segment)
- Network setting using N Configurator / XG5000 (Parameter setting, diagnosis and monitoring)
- I/O data of master station: 7kbytes
- Automatic monitoring of slave modules in the network: Auto-scan (XG5000)
- Multi master
- Easy configuration tool : N Configurator / XG5000



System configuration with LS ELECTRIC products

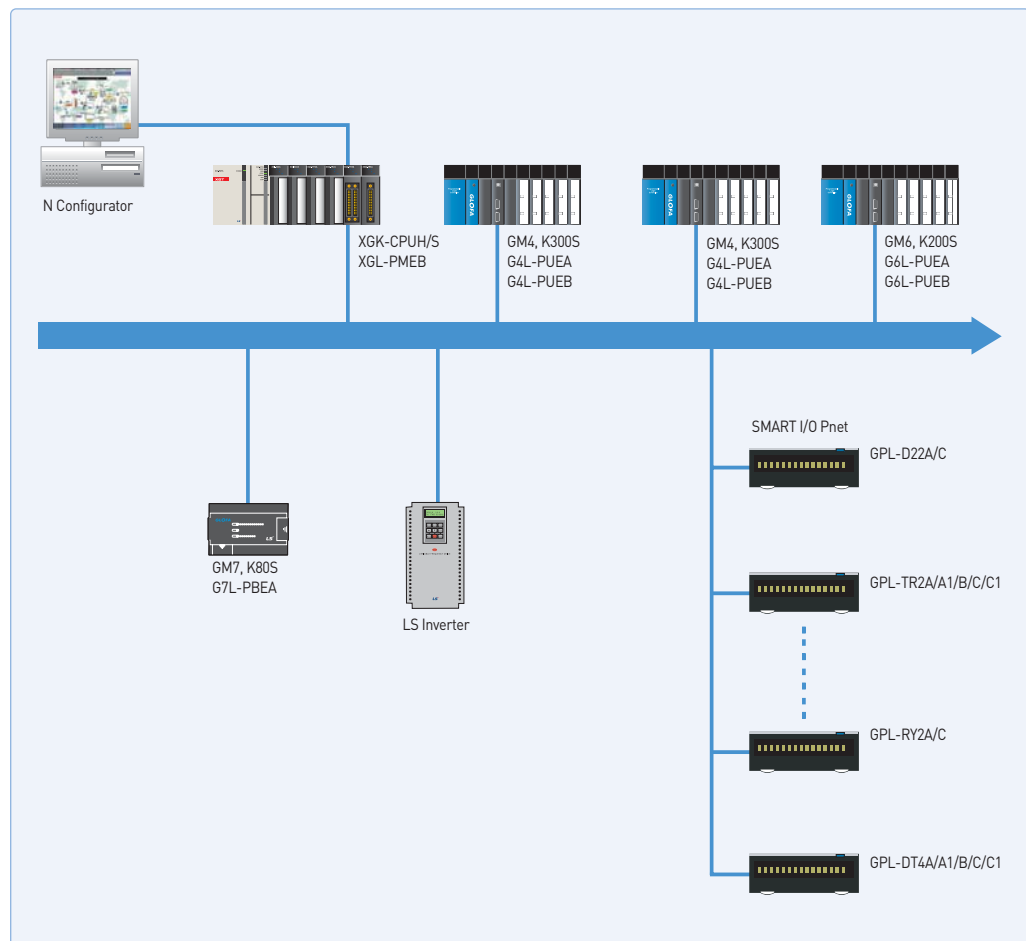

Specifications

Item	XGL-PMEB	
Module Type	Master	
Network Type	Profibus-DP	
Standard	EN50170/DIN19245	
Interface	RS-485 (Electric)	
Transmission Route	Bus type	
Modulation Type	NRZ	
MAC	Local Token Ring	
Max. Distance & Transmission Speed	Distance (m)	Transmission Speed (bps)
	1,200	9.6k/19.2k/31.25k/45.45k/93.7k
	1,000	187.5k
	400	500k
	200	1.5M
100	3M/6M/12M	
Max. number of stations per network	126	
Max. number of stations per segment	32 (including master & repeater)	
Max. number of modules per node	24 modules	
Cable used	Electric-twist shielded pair cable	
Max. communication size	7 KB	
Max. size per slave	244 bytes	
Max. number of units to be installed	XGK-CPUH/XGI-CPUU	XGK-CPUS/CPUA/CPUE
	12	12
Installation Position	XGK-CPUH/XGI-CPUU	XGK-CPUS/CPUA/CPUE
	Basic base ~ expansion stage 7	Basic base ~ expansion stage 3
Communication Parameters to set	XG5000 , SyCon (XGL-PMEA Dedicated Configuration Tool), N Configurator (XGL-PMEB/C Dedicated Configuration Tool)	
Internal-consumed current(mA)	500	
Weight (g)	88	

System configuration with other products

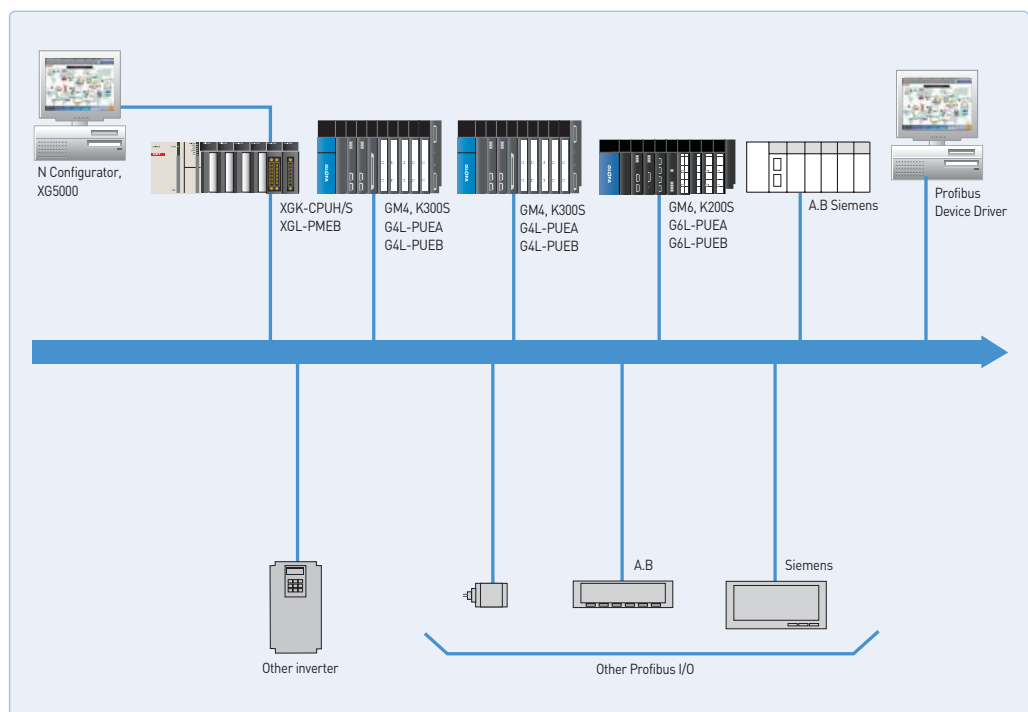

XGL-PSEA

- Profibus-DP
- Max. 98 stations available
- Other product Master <-> Pnet Slave I/F Module connect
- I/O configuration through XG5000 high-speed link parameter
- Provides online network status monitoring
- Global Command
 - Sync, Unsync, Freeze, Unfreeze



System configuration with other products

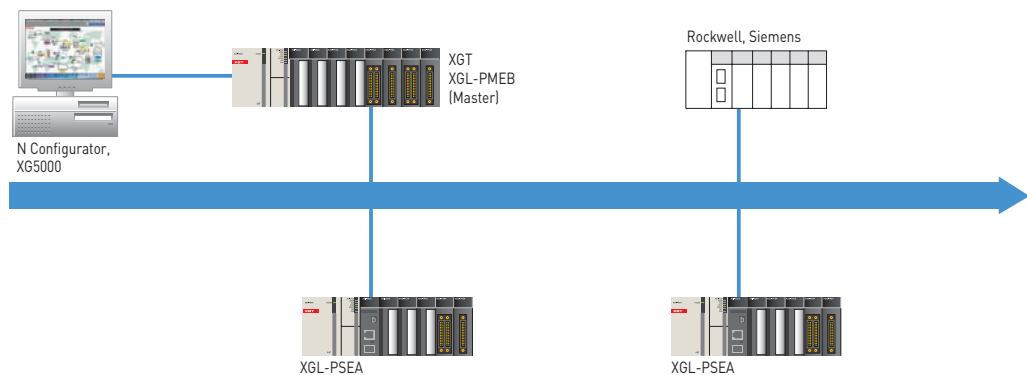

Specifications

Item	XGL-PSEA					
Standard	EN50170 / DIN 19245					
Interface	RS-485(Electric)					
Media access	Polling					
Topology	Bus					
Modulation	NRZ					
Network Interface	Auto baud rate					
Master / Slave	Slave					
Max. number of slave per network	99					
Max. number of slave per segment	32					
Cable	Shield twisted pair cable					
Max. I/O data	244 byte					
Configuration tool	XG5000					
Transmission distance and speed	Trans. speed(kbps)	9.6	19.2	93.75	187.5	500
	Max. network length(m)	1200	1200	1200	1000	400
	Trans. speed(kbps)	1500	3000	6000	12000	-
	Max. network length(m)	200	100	100	100	-
Max num. of node	99(0-98)					
Max num. of transmission block	24					
Max num. of installation	12ea (XGR: Max. 6ea)					
Installation	XGK-CPUU/H, XGI-CPUU			Main base ~ 7 th Expansion base		
	XGK-CPUE, XGI-CPUE			Main base ~ 1 st Expansion base		
	XGK-CPUA/S, XGI-CPUH/S			Main base ~ 3 rd Expansion base		
	XGR-CPUH/F, XGR-CPUH/T			Main base		
Current consumption (mA)	410					
Weight (g)	103					

XGL-PSRA

- Profibus-DP
- Remote base implementation
- Max. 98 stations available
- Various I/O module
 - DI/DO module
 - AI/AO/RTD/TC module
- Provides online network status monitoring
- Hot swap function



System configuration with other products

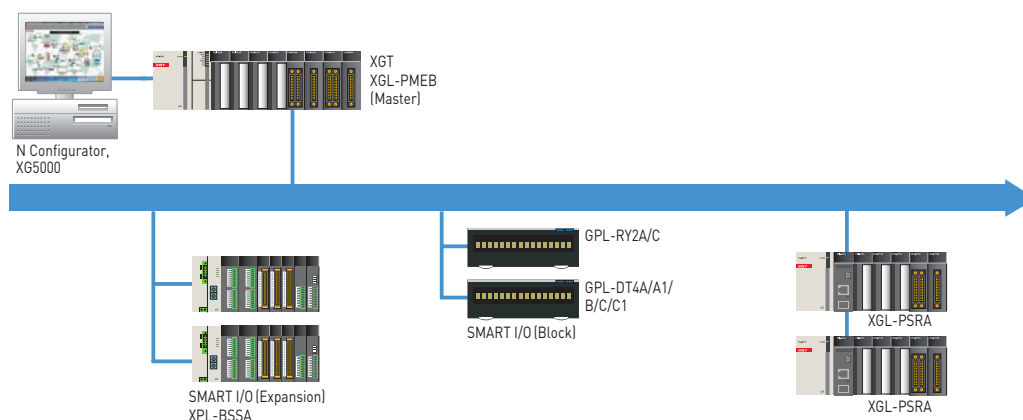

Specifications

Item	XGL-PSRA					
Standard	EN50170 / DIN 19245					
Interface	RS-485 (Electric)					
Media access	Polling					
Topology	Bus					
Modulation	NRZ					
Network Interface	Auto baud rate					
Master / Slave	Slave					
Max. number of slave per network	100					
Max. number of slave per segment	32					
Cable	Shield twisted pair cable					
Max. number of communication points	244 byte					
Transmission distance and speed	Trans. speed (kbps)	9.6	19.2	93.75	187.5	500
	Max. network length (m)	1200	1200	1200	1000	400
	Trans. speed (kbps)	1500	3000	6000	12000	-
	Max. network length (m)	200	100	100	100	-
Max num. of node	100 (0-99)					
Max. number of installation	12					
Max. digital I/O	768					
Max Analog I/O Channel	Input : 122ch. / Output : 96ch					
Current consumption (mA)	600					
Weight (g)	114					



XGL-RMEB

- Communication speed: 1Mbps
- Communication distance: Max. 750m
- Available to use max. 6 repeaters (Up to 5.25Km)
- Network management using Auto-scan (Slave module information)
- Multi-drop network with smart I/O
- Network diagnosis and monitoring by XG5000
- Max. 63 stations of slave modules controlled by one master module



System configuration

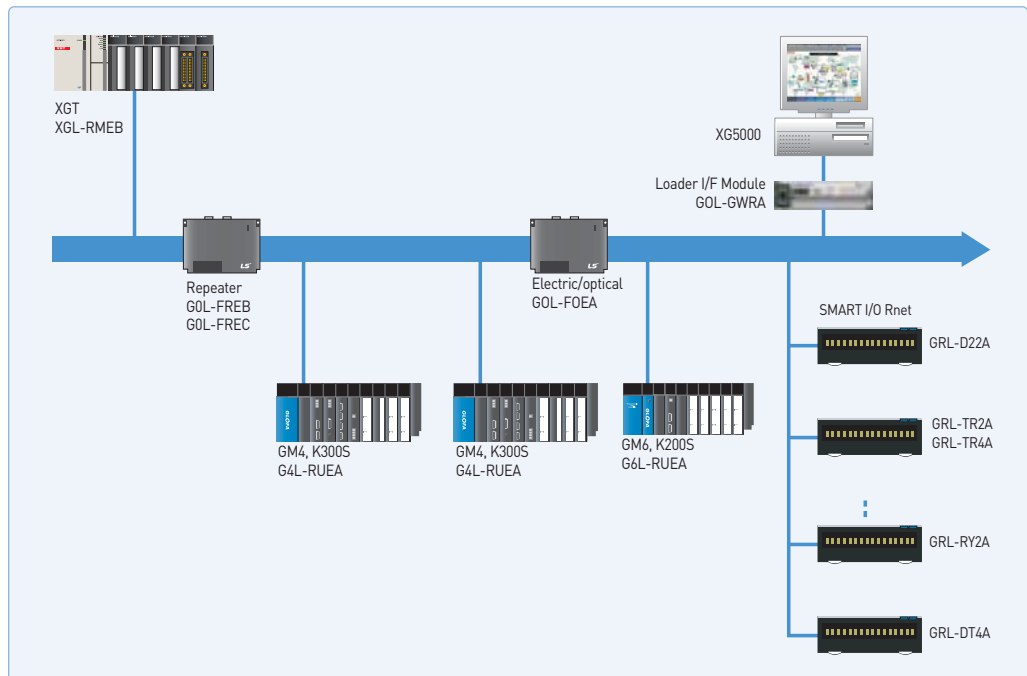

Specifications

Item		Specifications
Transmission Speed		1Mbps (Rnet I/F modules common)
Max. Tx distance		Max. 750m
Connection Cable		Twisted pair shielded cable - LIREV-AMESB 1Px22AWG (7/0.254):LS Cables
Maximum stations connected	Network	Master station 1[station no:0(fixed)] + Slave station 31[station no:1~63] = Max. 32 stations (In case of 32 stations, you have to use repeater.) - Only 1 master is available in the network.
	Diagnostic function	XG5000 : High Speed Link Monitoring
System characteristic		Available detachment and attachment of slave module during communication
Terminal resistance(Ω)		110(5%,1/2W)
Master/Slave operation		Only available as Master
XG5000 (HS Link)	Data Processing unit	Byte
	Tx/Rx cycle	Selection among 20ms, 50ms, 100ms, 200ms, 500ms, 1s, 5s, 10s(default :200ms)
	Max. Communication points.	3,720bytes(slave 31stations * 120bytes/station)
	Max. Block number	63(setting range : 0~62)
	Max. points by Block	120 Byte(60words)
	Max. Tx. Block number	32 Blocks
	HS Link number	Max. 12
Specification	Max. module mounted	12 modules(Main Base + Extension Base)
	Internal current consumption(mA)	410
	Weight(g)	115

SMART I/O

- Reduction of wiring and real-time control of distributed I/O
- Various I/O module (16/32 points)



Repeater specifications

Item	Specifications
Type	G0L-FREB: AC110V ~ AC220V, G0L-FREC: DC 24V
Communication speed	1Mbps
Transmission method	Twisted pair shield cable
Transmission distance	Max. 750m per repeater
Max. number of installation between stations	Max. 6 repeaters
Max. distance between stations	5.25Km (when 6 repeaters are installed)
Fault data reception	Error data transmission
Frame error check	CRC 16 check

Network cable and peripheral devices

Item	Specifications	Remarks
Twisted pair electric cable	LIREV-AMESB, 2×1mm, 18AWG	LS cable
RF terminator	110Ω , 1/2 W	-



XGL-FMEA

- Dedicated network for LS PLC
- Easy high-speed link parameter setup
- 1Mbps high-speed communication
- Max. 750m
- Max. 6ea repeater available (Max. expansion 5.25km)
- Network management through Auto scan
- Max. 12ea on 1ea base
- Deterministic Network through Token Passing & Broadcasting
- 3,840 Word for each station (Send 1920 Word /Receive 1920 Word)
- Max. number of block: Send 32blocks, Receive 64blocks, 60words for each block
- Max. communication points: 3840words (64block × 60word)
- Setup: Parameter download via XG5000
- Diagnosis by XG5000: Communication module information, High speed link fault, Auto scan



Specification

Item	Description
Communication speed	1Mbps
Encoding method	Manchester Biphas-L
Transmission length (for one segment)	Max. 750m
Transmission length (via repeater)	Max. 750m × (6ea repeaters+1)=5.25km
Transmission cable	Twisted pair shield cable
Max. number of connection	64stations (32stations /segment, 64stations for repeater)
Max. protocol size	256 bytes
Access method	Circulated Token Passing
Frame error check	CRC 16 check
Max. number of installation	12ea
Installation base	Main base or expansion base
Current consumption (mA)	410
Weight (g)	120

System configuration

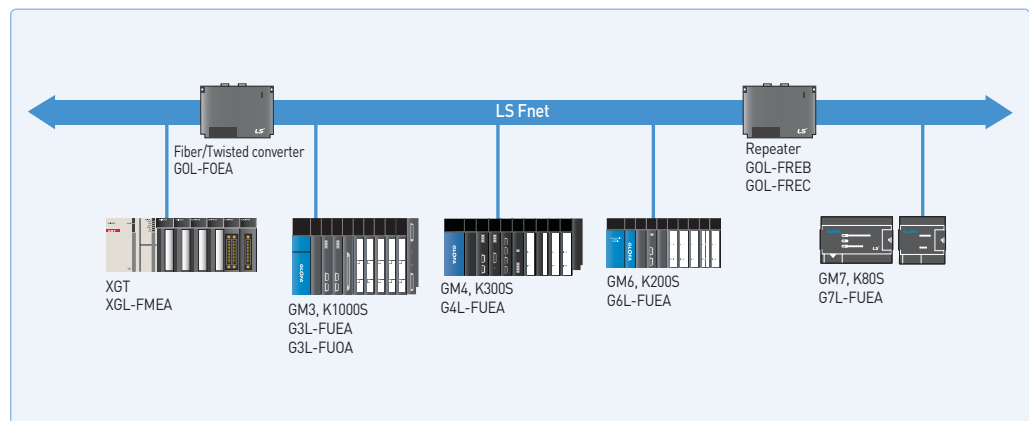

Ethernet switching hub

XGL-EH5T

- Rack type: No external power
- Reliability for industrial standard
- Auto Crossover
- FG (Frame Ground) for RJ-45 connector
- Decreased communication error by shielded FTP/STP cable



Specification

Item		XGL-EH5T
Transmission	Communication speed	10/100Mbps
	Port type	10/100BASE-TX, TP cable, RJ-45 socket, 5ports
	Interface	Auto-Crossing, Auto-Nego., Auto-Polarity
	Distance	100m
	Diagnosis	LED (PWR, Link status, Data)
Current consumption (mA)		550
Weight (g)		90

System configuration

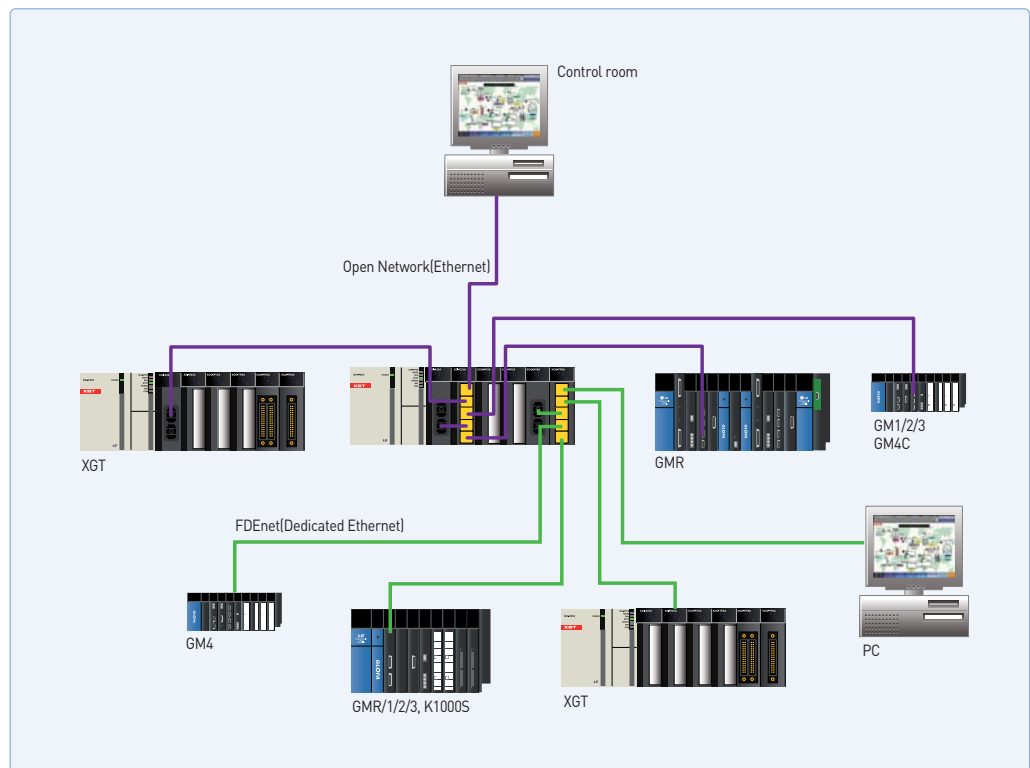

XGL-BIPT

- Compatibility: compatible with ANSI/ASHRAE 135-1995
- Provides 100BASE-TX media, and supports 100Mbps/Full Duplex.
- Up to 24 modules can be equipped per CPU module, and can be installed on main base or augmenting base. However, they can be installed only on main base in XGR system.
- With its internal switch function, it requires no switch or HUB, which reduces wires and provides flexibility in terms of installation.
- Makes cable works easier with its auto cross-over function.
- Provides various diagnosis functions and status information for modules and networks.



System configuration

XGL-BIPT module can be connected to BACnet Network using client/server, XGL-BIPT module is used as BACnet server, and sub-device can be controlled by being connected with exclusive power line communication (PLC).

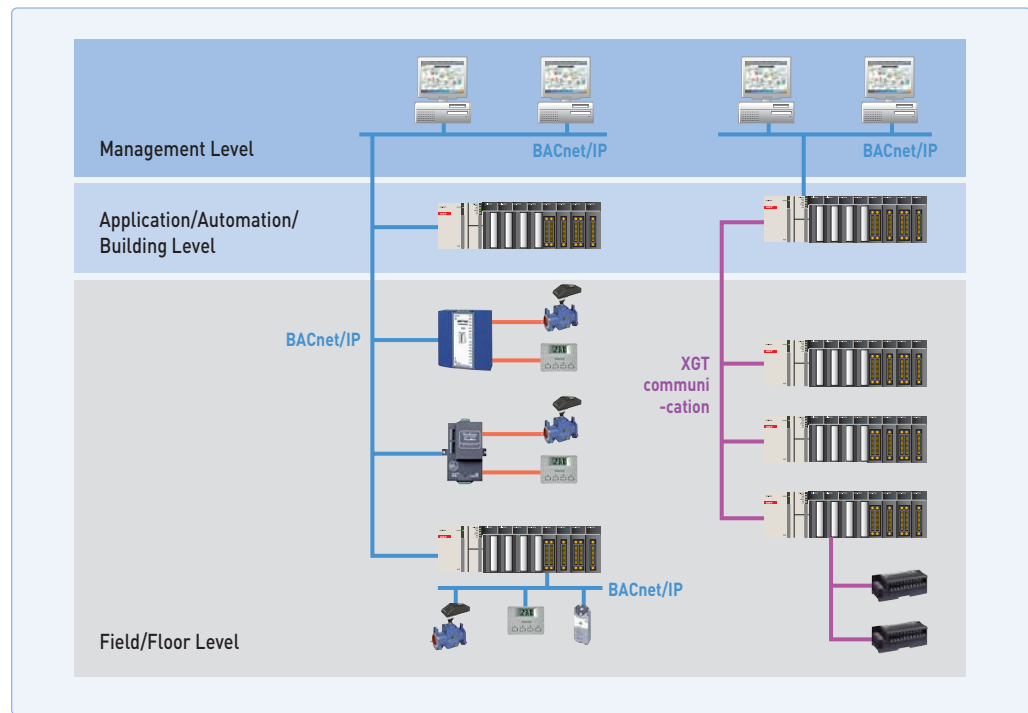

Device Profile	B-ASC + Client
Data Sharing	DS-RP-A, B DS-RPM-A, B DS-P-A, B DS-WPM-A, B
Device & Network Management	DM-DDB-B DM-DOB-B DM-DCC-A, B

Specifications

Item		Specification
Transmission standards	Transmission speed	100Mbps
	Transmission method	Base hand
	Maximum extension distance between nodes	100m
	Maximum size of protocol	1,536 bytes
	Communication access method	CSMA/CD
	Frame error check method	CRC 32 = $X^{32}+X^{28}+X^{25}+ \dots +X^2+X+1$
	Maximum number of units installed	24 units
Service	Service type	P2P/Server
	Maximum communication data	1,400 bytes
	Support object(Server)	Device Object Binary Input Object Binary Output Object Analog Input Object Analog Output Object
	Diagnostic function	Communication module information Service status information Media information Ping test Auto scan DCC(Device Communication Control) System log
Basic standards	External dimensions(mm)	90(H) × 27(W) × 90(D)
	Current consumption(mA)	400
	Weight(g)	102



Communication among PLCs

This is a system configuration communicating between XGT PLCs by serial communication. In this case, PLC 1 is the master (Client) and other PLC should be slaves (Server). It is called Master/Slave communication. Master PLC is defined by comm. basic parameter and P2P setting. And slave PLC is defined by basic parameter and driver setting.

Configuration

PLC1 reads present value, C0000 of PLC 2's up-counter and then saves it in M0200 of PLC1.

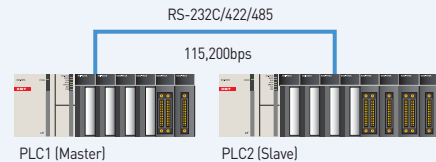

Data memory

PLC station	PLC memory	Setting Item
PLC 1	M0100	1. XG5000 parameter setting, 2. XG5000 programming
PLC 2	C0000	1. XG5000 parameter setting, 2. XG5000 programming

XG5000 setting

PLC setting 1 (Master)

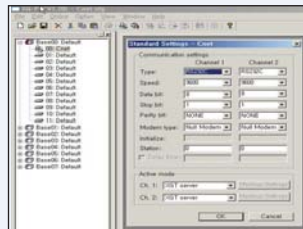

Communication basic parameter setting
Setting up station number, communication speed, etc. And setting up the operation mode as P2P

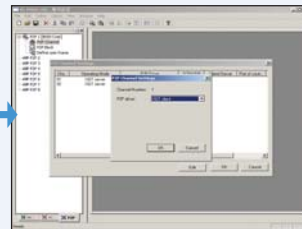

P2P channel setting
Setting up channel 01 as [XGT client]

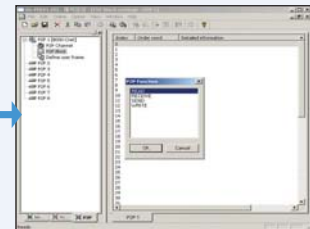

P2P setting
Setting up P2P block (READ)

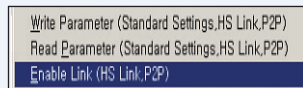

Enable Link
Enabling P2P for communication start



Parameter writing
Downloading parameters to PLC after online connection

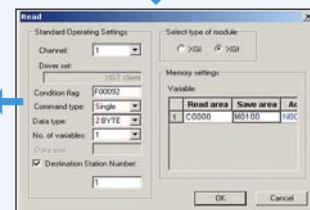

Communication data setting
Setting up Read area, Save area, etc.

PLC setting 2 (Slave)

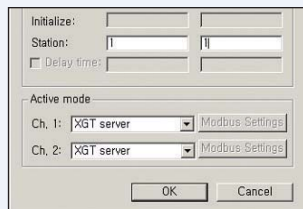

Communication parameter setting
Setting up station number and channel 01 mode as 1 and XGT server

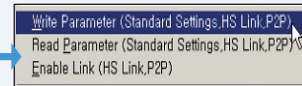

Parameter writing
Downloading parameters to PLC after online connection

* For basic parameter setting and SyCon setting/change, reset the module (Online reset).

XG5000 programming

PLC station 2 setting

Make up-counter program using CTU command

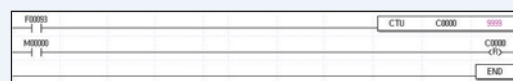

PLC station 1 setting

Check out the counter value of M0100 is transmitted.

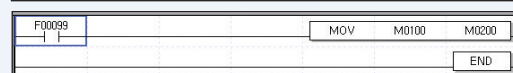

HMI communication configuration

This is a system configuration to monitor and control PLC (XGT) by XP (HMI). In this case, PLC is the slave (Server) and XP should be the master (Client). PLC is defined by comm. basic parameter and driver setting.

configuration



Data memory

PLC memory	Setting item	PMU
M000D1	1. XG5000 parameter setting	Using touch tag
	2. XG5000 programming	

XG5000 setting

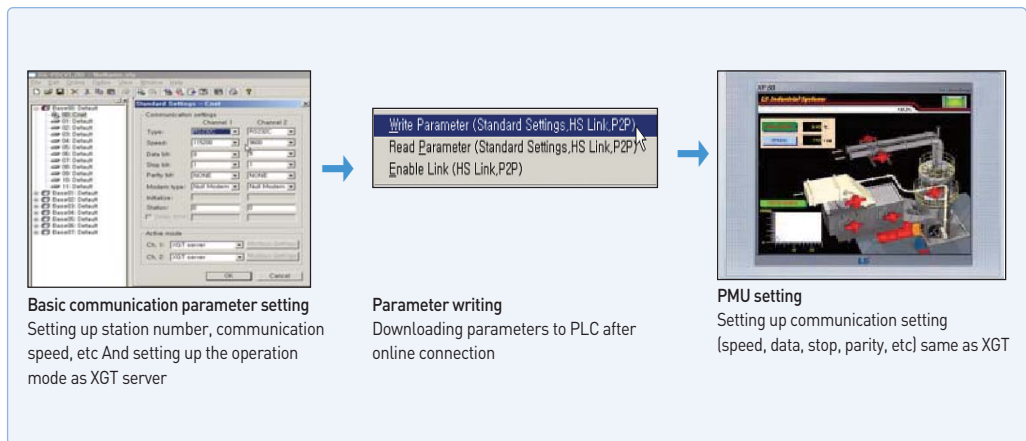

NETWORK

XG5000 programming

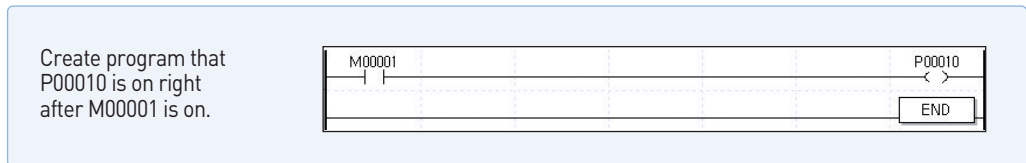

HMI communication configuration

This is a data communication system configuration among XGT PLCs via Ethernet network. In this case, communication is possible by HS link among PLCs. It just needs basic parameter setting and HS link item setting.

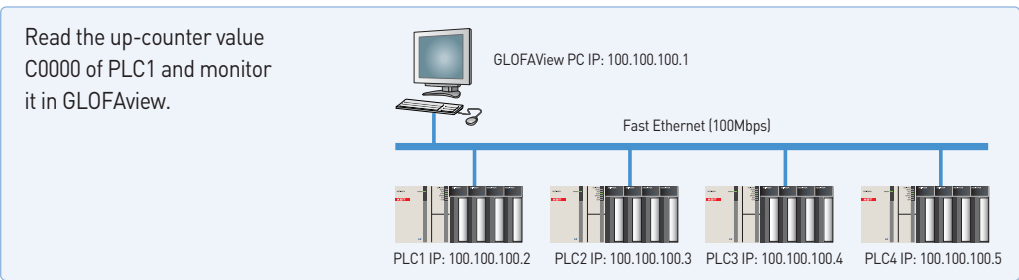

Data memory

PLC station	Setting item	GLOFAView
C0000	1. XG5000 parameter setting	Using analog tag
	2. XG5000 programming	

XG5000 setting

PLC setting 1 (Master)

Basic communication parameter setting
Specifying IP address and Subnet mask of PLC as above

Parameter writing
Downloading parameters to PLC after online connection

Ping Test
Starting diagnosis after inputting IP address of PLC

System Diagnosis
Selecting Ping Test

Communication test
Checking online and system diagnosis

* For basic parameter setting and SyCon setting/change, reset the module (Online reset).

XG5000 programming

Make the up-counter program using CTU command. Check out if the counter value of CTU value is transmitted.

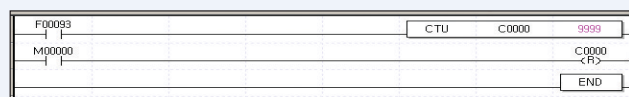

High-speed link communication configuration

This is a configuration for XGT to communicate each other via Ethernet. It just needs communication basic parameter setting and High-speed link item setting.

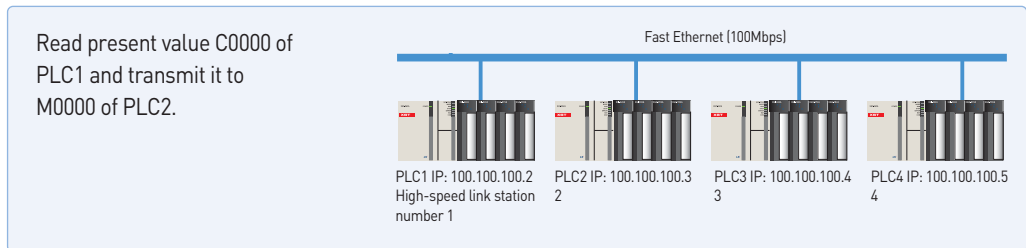

Data memory

PLC station	PLC memory	Setting Item
PLC 1	C0000	1. XG5000 parameter setting, 2. XG5000 programming
PLC 2	M0100	1. XG5000 parameter setting, 2. XG5000 programming

XG5000 setting

PLC station 1 (setting)

Basic communication parameter setting
Specifying HS link station, IP address and Subnet mask of PLC as above

Communication data setting
Setting up communication data in HS link item as above

Write Parameter (Standard Settings.HS Link.P2P)
Read Parameter (Standard Settings.HS Link.P2P)
Enable Link (HS Link.P2P)

Parameter writing
Downloading parameters to PLC after online connection

Write Parameter (Standard Settings.HS Link.P2P)
Read Parameter (Standard Settings.HS Link.P2P)
Enable Link (HS Link.P2P)

Enable Link
Enabling link for communication start

PLC station 2 (setting)

Basic communication parameter setting
Specifying HS link station, IP address and Subnet mask of PLC as above

Communication data setting
Setting up communication data in HS link item as above

Write Parameter (Standard Settings.HS Link.P2P)
Read Parameter (Standard Settings.HS Link.P2P)
Enable Link (HS Link.P2P)

Parameter writing
Downloading parameters to PLC after online connection

Write Parameter (Standard Settings.HS Link.P2P)
Read Parameter (Standard Settings.HS Link.P2P)
Enable Link (HS Link.P2P)

Enable Link
Enabling link for communication start

* For basic parameter setting and SyCon setting/change, reset the module (Online reset).

NETWORK

XG5000 programming

PLC1 setting
Make the up-counter program using CTU command

PLC2 setting
Check out if the counter value of M0100 is transmitted.

Communication example (Rnet)

Remote I/O configuration

LS ELECTRIC developed communication method is Rnet which is 'Distributed Control System' using Smart I/O. In this case, PLC is the master and the other Smart I/O are slaves. It just needs basic parameter setting for communication and High-speed link setting.

configuration

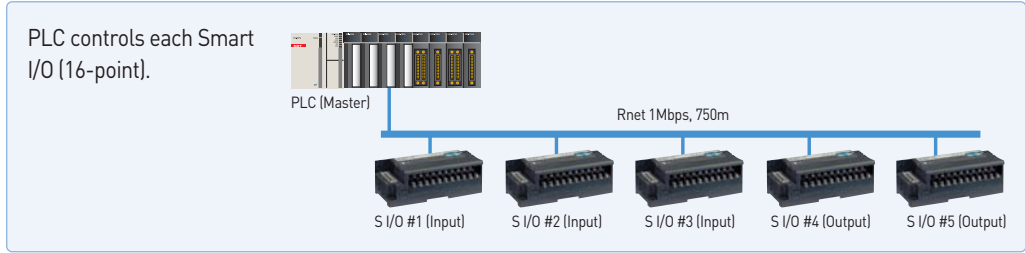

Data memory

Smart I/O #	Smart I/O address	PLC address	Setting item
1	P0000	P0010 (P00100~P0010F)	1. XG5000 parameter setting, 2. XG5000 programming
2	P0000	P0011 (P00110~P0011F)	
3	P0000	P0012 (P00120~P0012F)	
4	P0000	P0013 (P00130~P0013F)	
5	P0000	P0014 (P00140~P0014F)	

XG5000 setting

Communication data setting

Setting up type name, station number, address of each station's Smart I/O in HS link item as following example.

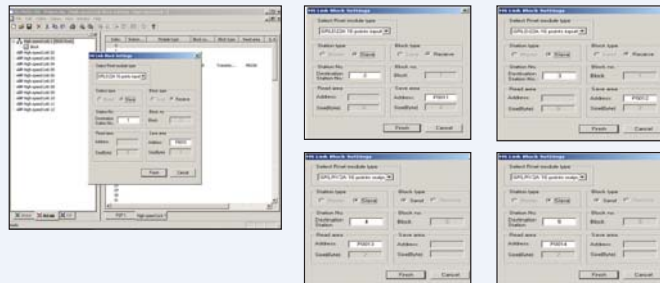

HS link registration completed



Parameter writing
Downloading parameters to PLC after online connection



Enable Link
Enabling link for communication start

* For basic parameter setting and SyCon setting/change, reset the module (Online reset).

XG5000 programming

Write a program using I/O address of Smart I/O.

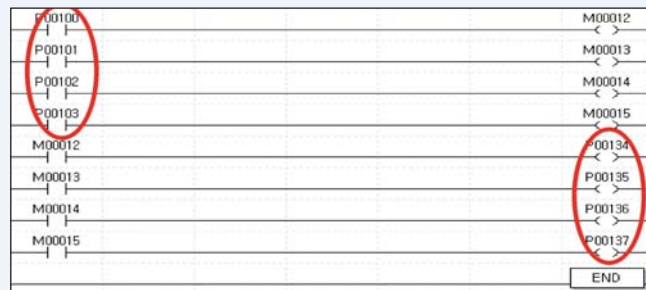

High-speed link communication among PLCs

XGT can create 'Distributed Control System' with Smart I/O, Inverter, pneumatic device via Profibus-DP. In this case, PLC is the master and the other devices such as Smart I/O are slaves. It just needs SyCon, basic parameter and High-speed link setting.

configuration

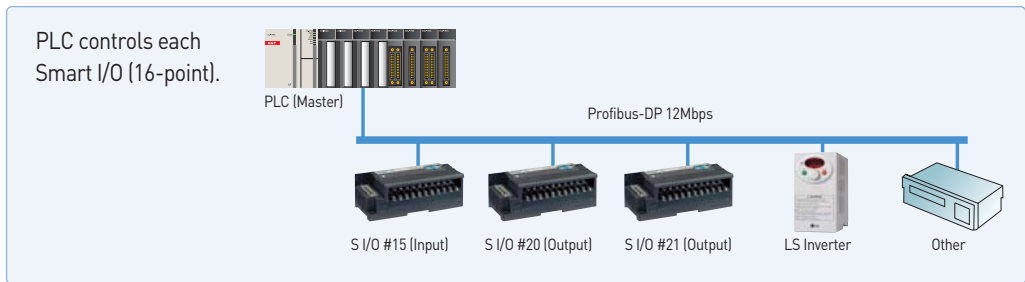

Data memory

Smart I/O #	Smart I/O address	PLC address	Setting item
15	P0000	P0010 (P00100-P0010F)	1. SyCon setting 2. XG5000 parameter setting, 3. XG5000 programming
20	P0000	P0011 (P00110-P0011F)	
21	P0000	P0012 (P00120-P0012F)	

XG5000 setting

SyCon setting
For detailed setting instruction, refer to page 43 (SyCon setting)

HS link setting
Uploading SyCon and setting up each Smart I/O station as following example

Parameter writing
Downloading parameters to PLC after online connection

Enable Link
Enabling link for communication start

NETWORK

* For basic parameter setting and SyCon setting/change, reset the module (Online reset).

XG5000 programming

Write a program using I/O address of Smart I/O Pnet

P0010 M00012
P0011 M00013
P0012 M00014
P0013 M00015
M00012 P0020
M00013 P0021
M00014 P0022
M00015 P0023
END

High-speed link communication among PLCs

XGT can create 'Distributed Control System' with Smart I/O, Inverter, pneumatic device via Dnet. In this case, PLC is the master and the other devices such as Smart I/O are Slaves. It just needs SyCon, basic parameter and High-speed link setting.

configuration

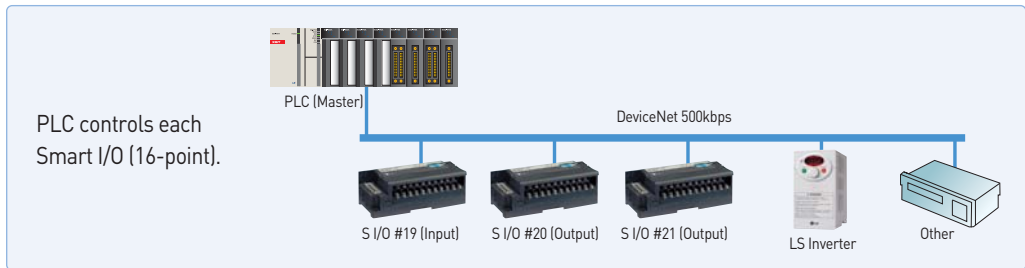

Data memory

Smart I/O #	Smart I/O address	PLC address	Setting item
19	P0000	P0010 (P00100~P0010F)	1. SyCon setting 2. XG5000 parameter setting, 3. XG5000 programming
20	P0000	P0011 (P00110~P0011F)	
21	P0000	P0012 (P00120~P0012F)	

XG5000 setting

SyCon setting
For detailed setting instruction, refer to page 43 (SyCon setting)

HS link setting
Uploading SyCon and setting up each Smart I/O station as following example

Parameter writing
Downloading parameters to PLC after online connection

Enable Link
Enabling link for communication start

* For basic parameter setting and SyCon setting/change, reset the module (Online reset).

XG5000 programming

Write a program using I/O address of Smart I/O Dent.

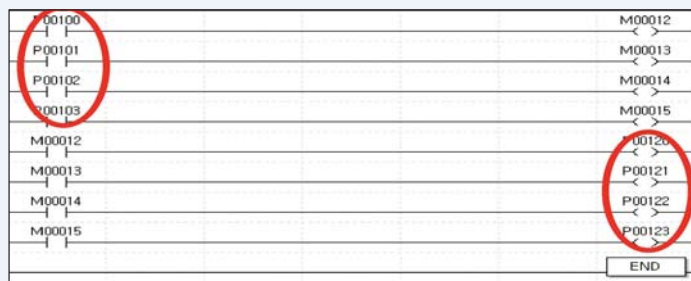

SyCon is the dedicated software that help user set up the communication environment for Profibus-DP and DeviceNet more easily and conveniently.

Example of application

New file
Select fieldbus that is used.

Basic communication parameter setting
Select [Master] in Insert menu.

Master module setting
Select [COM-C-DNM] for DeviceNet.
Select [COM-C-DPM] for Profibus-DP.

Bus parameter setting
Set up communication speed of master module.

Master module setting
After clicking the port button, check, the right check-box.

Automatic network scan of connected Smart I/O
Perform automatic network scan after station number setting and wiring with remote device such as Smart I/O.
At this time, all remote devices should be in normal connection (Power-On, etc).
After network scan is completed, press [Automatic Configuration] button and [OK] button.

Network checking
Check normal network (remote) condition.

Parameter download

Disconnect
Disconnect the port in Device Assignment.

Features

- Wiring reduction and real time control of distributed I/O
- Supporting Rnet, DeviceNet, Profibus-DP, Modbus (RS-422/485), RAPIEnet
- Various I/O (DC/TR/Relay) modules with the unit of 16/32 points



Digital I/O specifications

Item	Input		Output			Mixed module	
	DC (Sink/Source)		Transistor (Sink)	Relay	DC (Sink/Source)	Transistor (Sink)	
No. of point	16	32	16	32	16	16	
Rated input (Load voltage)	DC 24 V		DC 24 V		DC 24 V/AC 110 V/220 V		
Input current (Load current)	7 mA		0.1 A/2 A, 0.5 A/3 A		2 A/5 A		
Response time	Off → On	3 ms or less	3 ms or less	3 ms or less	3 ms or less	3 ms or less	
	On → Off	3 ms or less	3 ms or less	3 ms or less	3 ms or less	3 ms or less	
Common	16 points/COM		16 points/COM		16 points/COM		
Current consumption	200 mA	300 mA	280 mA	380 mA	550 mA	350 mA	
Network	Rnet	GRL-D22C	GRL-D24C	GRL-TR2C1	GRL-TR4C1	GRL-RY2C	GRL-DT4C1
	Profibus-DP	GPL-D22C	GPL-D24C	GPL-TR2C/TR2C1	GPL-TR4C/TR4C1	GPL-RY2C	GPL-DT4C/DT4C1
	DeviceNet	GDL-D22C	GDL-D24C	GDL-TR2C/TR2C1	GDL-TR4C/TR4C1	GDL-RY2C	GDL-DT4C/DT4C1
	Modbus	GSL-D22C	GSL-D24C	GSL-TR2C1	GSL-TR4C1	GSL-RY2C	GSL-DT4C1
RAPIEnet	-	GEL-D24C	-	GEL-TR4C1	GEL-RY2C	-	GEL-DT4C1

Note1) C Source, Rated current: 0.5A, terminal separated type
C1 Sink, Rated current: 0.5A terminal separated type

Analog I/O specifications

Item	GPL-AV8C/GEL-AV8C	GPL-AC8C/GEL-AC8C	Item	GPL-DV4C/GEL-DV4C	GPL-DC4C/GEL-DC4C
Input channels	8 channels		Output channels	4 channels	
Analog input	DC 1-5 V, 0-5 V, 0-10 V,	0-20 mA, 4-20 mA,	Digital input	0-4000, 0-8000, -8000-8000	0-8000
	-10~+10 V	-20-20 mA		DC 1-5 V, 0-5 V, 0-10 V,	0-20 mA, 4-20 mA
Digital output	0-4000, 0-8000, -8000-8000	0-4000, -8000-8000	Analog output	-10~+10 V	
Input impedance	1 MΩ	250 Ω		Load impedance	1 KΩ or more (0-5 V or 1-5 V)
Max. resolution	±15 V	±30 mA	Resolution	2 KΩ or more (0-10 V or -10-10 V)	2.5 μA
	1.25 mV	2.5 μA		Accuracy	±0.3% (full scale, Ta=0-55 °C)
Accuracy	±0.3% (full scale, Ta=0-55 °C)		Accuracy	±0.4% (full scale, Ta=0-55 °C)	
	±0.4% (full scale, Ta=0-55 °C)			Conversion speed	10 ms or less/4 channel
Conversion speed	10 ms or less/8 channel		Response period	10 ms or less/8 channels + Transmission period (ms)	
Response period	10 ms or less/8 channels + Transmission period (ms)			Analog input/output terminal with FG→Insulation	
Insulation method	Analog input/output terminal with Communication terminal→Insulation		Insulation method	Analog input/output terminal with Communication terminal→Insulation	
	Analog input/output terminal with each channel→No insulation			Analog input/output terminal with each channel→No insulation	
External power supply	DC 24 V (21.6 ~ 26.4)		External power supply	insulation	DC 24 V (20.4 ~ 28.8)
External current consumption	DC 24 V : 220 mA		External current consumption	210 mA	240 mA
Weight (kg)	0.313	0.313	Weight (kg)	0.314	0.322

Communication specifications

Item	Rnet (LS dedicated network)	Profibus-DP	DeviceNet	MODBUS	RAPIEnet(RJ-45)
Protocol	LS ELECTRICdedicated protocol (Fnet for Remote)	Profibus-DP (RS-485/EN50170)	DeviceNet (CAN)	MODBUS (RS-422/485)	Fast Ethernet
Transmission speed	1 Mbps	9.6 Kbps ~ 12 Mbps	125/250/500 Kbps	2.4 Kbps ~ 38.4 Kbps	100Mbps
Transmission distance	750 m/segment	100 m ~ 1.2 km	500/250/125 m (Thin cable: 100 m)	500 m	100M
Topology	Bus Token	Bus	Trunk & Drop	Bus	CRC32
Transmission	Pass & Broadcast	Token Pass & Master/Slave (Poll)	CSMA/NBA (Poll, Cyclic, COS, Bit Strobe)	Master/Slave (Poll)	CSMA/CD
No. of stations	32/segment (Input: 32, Output: 32)	32/segment, 99/network	64	32	64

(Modbus TCP/IP, Ether Net/IP Adapter) 84 / 85

Features

- IEEE 802.3 standard
- Modbus TCP/IP, EtherNet/IP
- 10/100BASE-TX media
- Ethernet Twisted pair 2ports (RJ-45)
- 2channels Ethernet MAC
- Auto-Negotiation/Auto-Crossover
- Various system configuration



Specification

Items		XEL-BSSA	XEL-BSSB
I/F	Protocol	Modbus TCP	EtherNet/ IP
	Transmission speed	10 /100Mbps	
	Connector	RJ-45(2ports)	
	Topology	Software(BootpServer)	
	IP setup	Bus, Star	
Max. expansion module		8ea	
Max. digital I/O point		256 points	
Max. analog I/O channel		32ch (Input 16ch, Output 16ch)	
Operating power	Rated voltage	DC 24V	
	Range	DC19.2 ~ 28.8V	
	Rated current	1.5A	
	Insulation	Non-Insulation, Comm. Part insulation	

System configuration

Items	Description	Max. I/O point			
Digital I/O	XBE-DC08A	DC24V input 8pt	Max. 256 points		
	XBE-DC16A	DC24V input 16pt			
	XBE-DC32A	DC24V input 32pt			
	XBE-RY08A	Relay output 8pt			
	XBE-RY16A	Relay output 16pt			
	XBE-TN08A	Tr output 8pt, Sink			
	Analog, Temperature	XBE-TP08A	Tr output 8pt, Source	Input Max. 16ch Output Max. 16ch	
		XBE-TN16A	Tr output 16pt, Sink		
		XBE-TP16A	Tr output 16pt, Source		
		XBE-TN32A	Tr output 32pt, Sink		
		XBE-TP32A	Tr output 32pt, Source		
		XBE-DN16A	DC24V input 8pt, Tr output 8pt		
Analog, Temperature		XBF-AD04A	Current/Voltage input 4Ch		Input Max. 16ch Output Max. 16ch
		XBF-AD04C	4-channel analog input (current / voltage, resolution : 1/16000)		
		XBF-DC04A	Current output 4Ch		
		XBF-DV04C	4-channel analog input (voltage, resolution : 1/16000)		
		XBF-DV04A	Voltage output 4Ch		
		XBF-DV04C	4-channel analog input (voltage, resolution : 1/16000)		
	XBF-RD04A	RTD input 4Ch			
	XBF-TC04S	TC input 4Ch			

* When Digital input and Analog input is used together or Digital output Analog output is used, configure the system within 32bytes
 (EX) If 4ch analog input is used, Digital input can be used max. 192points

Externals and inscriptions

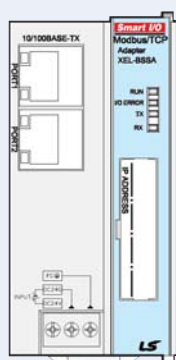

Item	LED status
RUN	Operation status
	On: Normal operation Off: Abnormal operation
I/O ERROR	Interface status of expansion module
	On: Expansion module error Off: Normal operation
TX	Data send status to master
	On: Under transmission Off: No data
RX	Data receive status from master
	On: Under receiving Off: No data

Dimension

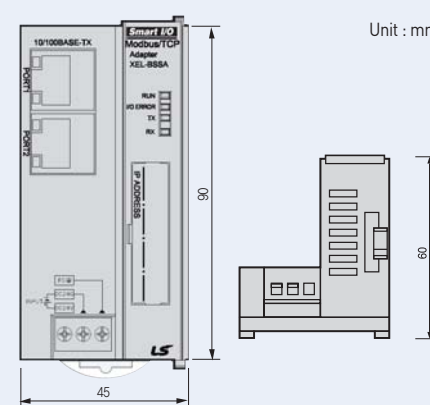

Unit : mm

45

85

60



Features

- Max. 63 stations
- Flexible connection via DeviceNet
- Utilize same I/O modules with XGB
 - Max. 512 I/O points
 - Max. 32 channels analog input/output



Specification

Items	Description			
Communication Specification	Poll, Bit-strobe, COS/Cyclic			
	Group 2 only slave			
	Auto baud rate			
Module's Type	Slave			
Max. Node Number [MAC ID]	64[0-63]			
Number of Expansion I/O Slots	8			
Max. DC I/O Data Size	Input:32bytes / Output:32bytes			
Max. Analog Channels	Input : 16Channels / Output : 16Channels			
Speed & Distance	Comm. Speed	125 kbps	250 kbps	500 kbps
	Distance	500 m	250 m	100 m
Input Power	System Power	DC 24V		
	Range	19.2V ~ 28.8V(11V operate)		
	Output Voltage/Current	5V(±20%) /1.5A		
Weight[g]	100			

* When I/O module is installed, check the current consumption
(Max. Current: 1.5A)

System configuration

Items	Description	Max. I/O point	
Digital I/O	XBE-DC08A	DC24V input 8pt	256points
	XBE-DC16A	DC24V input 16pt	
	XBE-DC32A	DC24V input 32pt	
	XBE-RY08A	Relay output 8pt	
	XBE-RY16A	Relay output 16pt	
	XBE-TN08A	Tr output 8pt, Sink	
	XBE-TP08A	Tr output 8pt, Source	
	XBE-TN16A	Tr output 16pt, Sink	
	XBE-TP16A	Tr output 16pt, Source	
	XBE-TN32A	Tr output 32pt, Sink	
	XBE-TP32A	Tr output 32pt, Source	
	XBE-DN16A	DC24V input 8pt, Tr output 8pt	
Analog, Temperature	XBF-AD04A	Current/Voltage input 4Ch	16channels
	XBF-AD04C	4-channel analog input (current / voltage, resolution : 1/16000)	
	XBF-DC04A	Current output 4Ch	
	XBF-DV04C	4-channel analog input (voltage, resolution : 1/16000)	
	XBF-DV04A	Voltage output 4Ch	
	XBF-DV04C	4-channel analog input (voltage, resolution : 1/16000)	
	XBF-RD04A	RTD input 4Ch	
XBF-TC04S	TC input 4Ch		

* When Digital input and Analog input is used together or Digital output Analog output is used, configure the system within 32bytes
(Ex) If 4ch analog input is used, Digital input can be used max. 192points

Externals and inscriptions

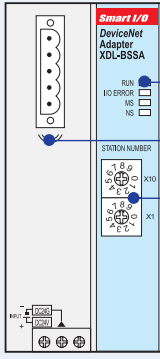

XDL-BSSA LED

DeviceNet port

Station switch

Item	LED status
RUN	ON : Normal
	OFF : Module error
I/O ERROR	ON : I/O module error
	OFF : Normal
MS	Green ON: Normal
	Green blink: Normal
	Red ON: Module error
NS	Green ON: Normal
	Green blink: Waiting
	Green off: Comm. stop
	Red ON: Network error
	Red blink: Disconnect

Dimension

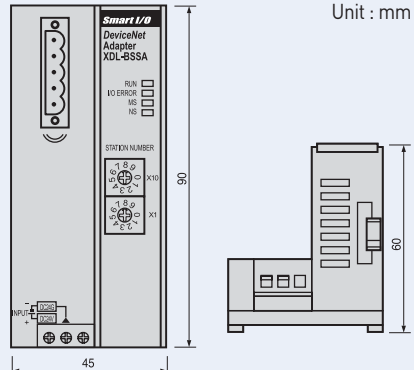

Unit : mm

SMART I/O (Profibus-DP adapter)

Features

- Max. 100 stations (32stations per segment)
- Flexible connection via Profibus
- Utilize same I/O modules with XGB
 - Max. 512 I/O points
 - Max. 32 channels analog input/output



Specification

Item		Performance Specification					
Transmission	Standard	EN50170 / DIN 19245					
	Interface	RS-485(Electric)					
	Media Access	Polling					
	Topology	BUS					
	Encoding Method	NRZ					
	Interface	Sync mode , Freeze mode Auto baud rate					
	Master/Slave	Slave					
	Cable Type	Twisted Pair Shielded Cable					
	Comm. Distance	Kbps	9.6	19.2	93.75	187.5	500
			m	1200	1200	1200	1000
		kbps	1500	3000	6000	12000	-
			m	200	100	100	100
	Max. Node Number	100 (0 ~ 99)					
Number of Expansion I/O Slots	8						
IO Data Size	64bytes (Input:32bytes/Output:32bytes)						
Number of Analog Channels	32Channels (Input : 16Channels/Output :16Channels)						
Input Power	System Power	Supply Voltage : DC 24Vdc 19.2 ~ 28.8Vdc					
	Output Voltage/Current	5V(± 20%) / 1.5A					
Weight(g)	100						

* When I/O module is installed, check the current consumption (Max. Current: 1.5A)

System configuration

Items	Description	Max. I/O point	
Digital I/O	XBE-DC08A	DC24V input 8pt	256points
	XBE-DC16A	DC24V input 16pt	
	XBE-DC32A	DC24V input 32pt	
	XBE-RY08A	Relay output 8pt	
	XBE-RY16A	Relay output 16pt	
	XBE-TN08A	Tr output 8pt, Sink	
	XBE-TP08A	Tr output 8pt, Source	
	XBE-TN16A	Tr output 16pt, Sink	
	XBE-TP16A	Tr output 16pt, Source	
	XBE-TN32A	Tr output 32pt, Sink	
	XBE-TP32A	Tr output 32pt, Source	
	XBE-DN16A	DC24V input 8pt , Tr output 8pt	
Analog, Temperature	XBF-AD04A	Current/Voltage input 4Ch	16channels
	XBF-AD04C	4-channel analog input (current/ voltage, resolution : 1/16000)	
	XBF-DC04A	Current output 4Ch	
	XBF-DV04C	4-channel analog input (voltage, resolution : 1/16000)	
	XBF-DV04A	Voltage output 4Ch	
	XBF-DV04C	4-channel analog input (voltage, resolution : 1/16000)	
	XBF-RD04A	RTD input 4Ch	
	XBF-TC04S	TC input 4Ch	

* When Digital input and Analog input is used together or Digital output Analog output is used, configure the system within 32bytes
(Ex) If 4ch analog input is used, Digital input can be used max. 192points

Externals and inscriptions

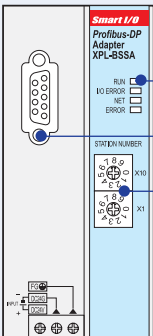

XDL-BSSA LED

Profibus-DP port

Station switch

Item	LED status
RUN	ON : Normal
	Blink: Waiting or comm. error
	OFF : Module error
I/O ERROR	ON : I/O module error OFF : Normal
NET	ON : Data send/receive OFF : Disconnection
ERROR	ON : Comm. error
	OFF : Normal

Dimension

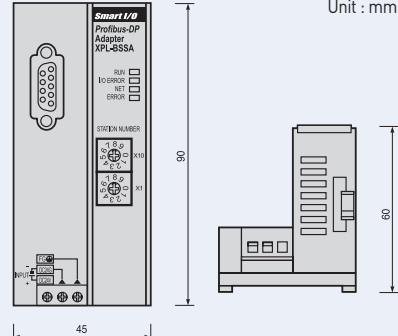

Unit : mm

Features

- Max. 63 stations
- LS dedicated protocol (Rnet)
- Utilize same I/O modules with XGB
 - Max. 512 I/O points
 - Max. 32 channels analog input/output



Specification

Item	Performance Specification	
Transmission	Tran. Rate	1Mbps
	Transmission Path	Bus type
	Method	750m
	Max. Cable Length	5 pin connector
	Connector type	Twisted Pair Shielded Cable
	Cable type	32(non-used repeater),
	No. of Station	64(used repeater)
	(Included Master)	512(Input : 256, Output: 256)
	Max. Digital I/O points	96
	Max. Analog I/O points	Digital I/O 8
	Number of I/O Slots	Analog I/O 4
	Selection of Latch/Clear	handling of mode change switch
Rated Voltage/current	DC24V/0.55A	
Weight (g)	100	

* When I/O module is installed, check the current consumption
[Max. Current: 1.5A]

System configuration

Items	Description	Max. I/O point	
Digital I/O	XBE-DC08A	DC24V input 8pt	256points
	XBE-DC16A	DC24V input 16pt	
	XBE-DC32A	DC24V input 32pt	
	XBE-RY08A	Relay output 8pt	
	XBE-RY16A	Relay output 16pt	
	XBE-TN08A	Tr output 8pt, Sink	
	XBE-TP08A	Tr output 8pt, Source	
	XBE-TN16A	Tr output 16pt, Sink	
	XBE-TP16A	Tr output 16pt, Source	
	XBE-TN32A	Tr output 32pt, Sink	
	XBE-TP32A	Tr output 32pt, Source	
	XBE-DN16A	DC24V input 8pt, Tr output 8pt	
	Analog, Temperature	XBF-AD04A	
XBF-AD04C		4-channel analog input (current /voltage, resolution : 1/16000)	
XBF-DC04A		Current output 4Ch	
XBF-DV04C		4-channel analog input (voltage, resolution : 1/16000)	
XBF-DV04A		Voltage output 4Ch	
XBF-DV04C		4-channel analog input (voltage, resolution : 1/16000)	
XBF-RD04A		RTD input 4Ch	
XBF-TC04S		TC input 4Ch	

* When Digital input and Analog input is used together or Digital output Analog output is used, configure the system within 32bytes
(Ex) If 4ch analog input is used, Digital input can be used max. 192points.

Externals and inscriptions

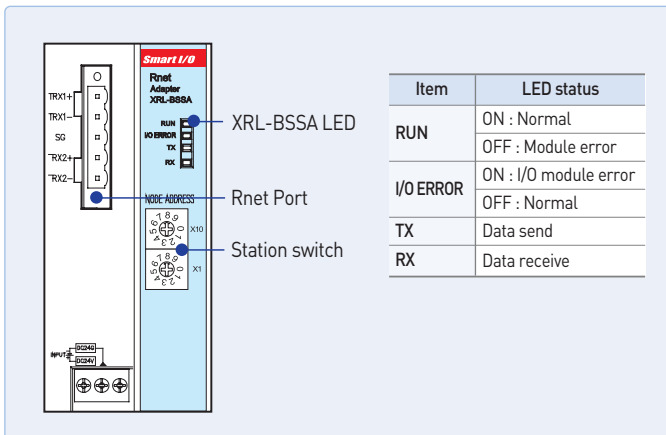

Dimension

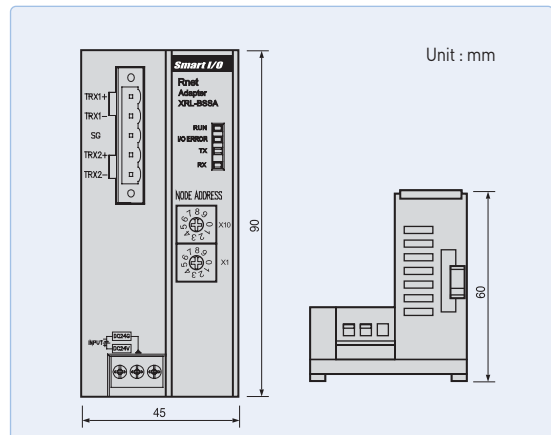

SMART I/O (Features)

Smart I/O Rnet system

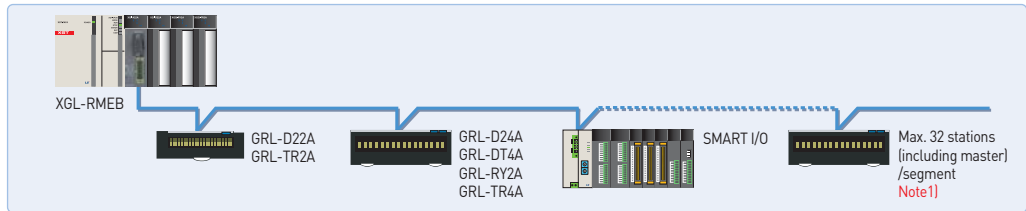

Smart I/O Modbus system

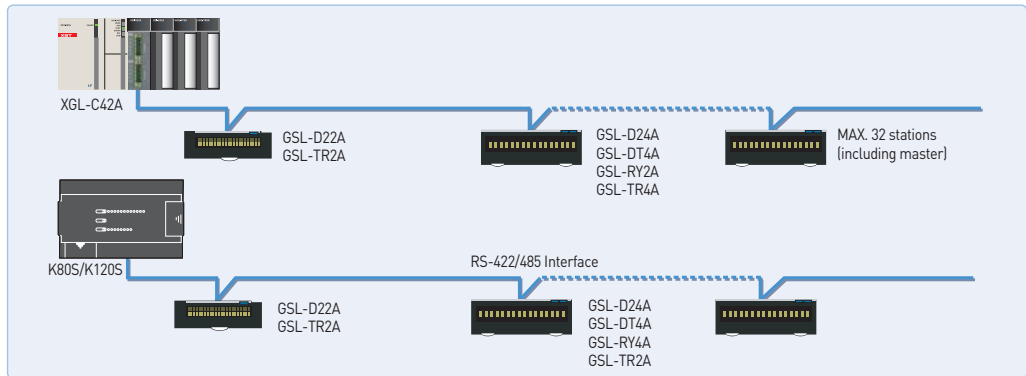

Smart I/O Profibus-DP system

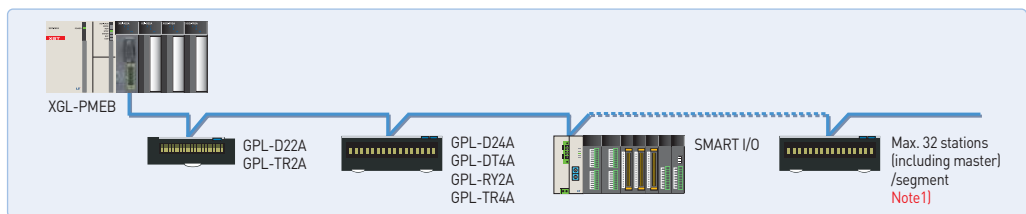

Smart I/O DeviceNet system

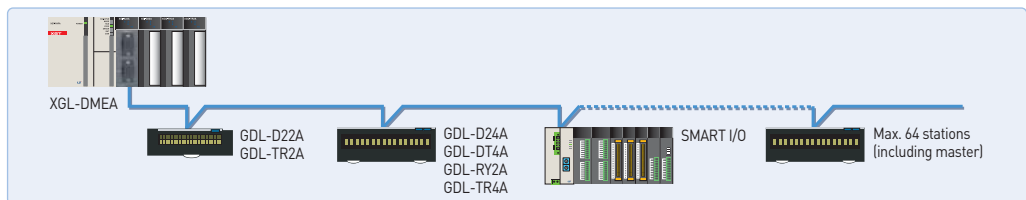

Note1) Segment: Communication section that does not use repeater or second master.

Dimensions

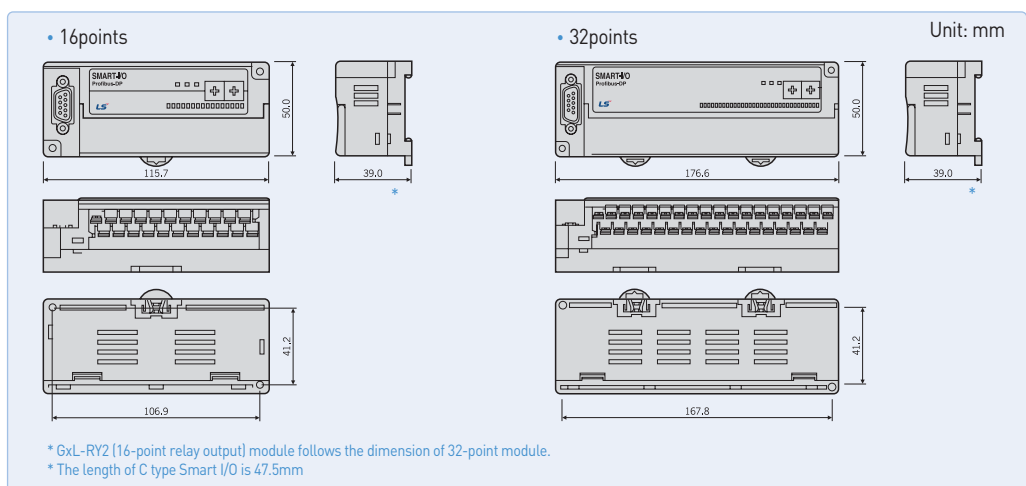

Network Standard

Item	Rnet (LS dedicated network)	Profibus-DP	DeviceNet	MODBUS	RAPINet (RJ-45)
Protocol	LSELECTRIC dedicated protocol (Fnet for Remote)	Profibus-DP (RS-485/EN50170)	DeviceNet (CAN)	MODBUS (RS-422/485)	Fast Ethernet
Transmission speed	1 Mbps	9.6 Kbps ~ 12 Mbps	125/250/500 Kbps	2.4 Kbps ~ 38.4 Kbps	100Mbps
Transmission distance	750 m/segment	100 m ~ 1.2 km	500/250/125 m (Thin cable: 100 m)	500 m	100M
Topology	Bus Token	Bus	Trunk & Drop	Bus	CRC32
Transmission	Pass & Broadcast	Token Pass & Master/Slave (Poll)	CSMA/NBA (Poll, Cyclic, COS, Bit Strobe)	Token Pass & Master/Slave (Poll)	CSMA/CD
No. of stations	32/segment (Input: 32, Output: 32)	32/segment, 99/network	64	32	64

NETWORK





Special

XGT series offer diverse special modules such as analog, HSC, and positioning to satisfy complicated industrial needs

Contents	92 XGT special module
	94 Analog input module
	96 2Wire Analog input module
	97 Analog input module [Isolated]
	98 Analog input module [Example]
	99 Analog output module
	100 Analog output module [Example]
	101 Analog input/output module
	102 HART interface analogue/digital conversion module
	103 High-speed counter module
	106 8-Channel high speed counter module
	107 High-speed counter module [Example]
	110 Positioning module (XPM)
	112 Positioning module (Network Type)
	114 XG5000
	116 Motion Module [EtherCAT]
	117 RTD input module
	118 Thermocouple module
	119 Temperature controller
	120 Event input module
	122 Datalog module



Revolution of easy to use ... XGT Special module

Fast processing of parameter and data of special module

- Continually refreshing operation data of special module by CPU module
- Including contact points such as conversion data of AD/DA module and command of HSC & positioning module

Easy- to-use(Easy operation parameter setting and data monitoring)

- Convenient parameter setting available through XG5000
- Providing useful functions that can monitor and test operation data and contact points through XG5000

Simple maintenance (Changing online module)

- Without turning off and holding CPU, users can change special module with ease.

Before

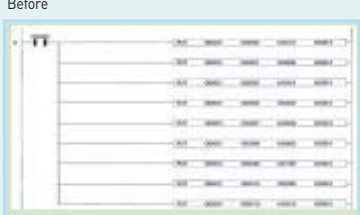



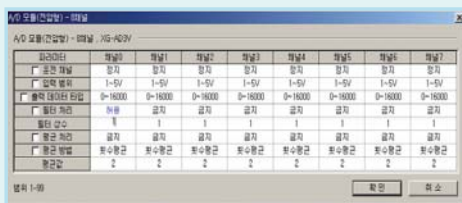

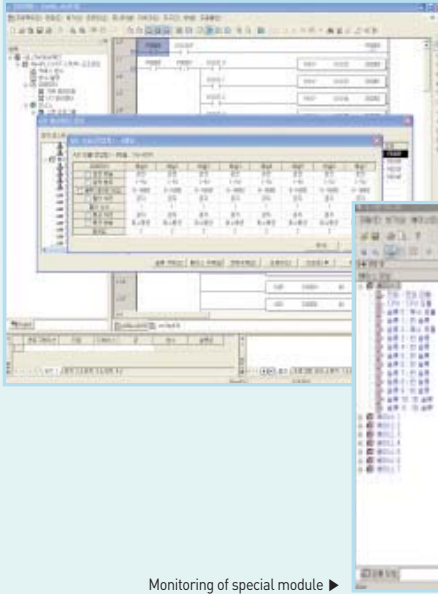

◀ Example of programming

Monitoring of special module ▶



Analog input/output module



Analog input module

XGF-AV8A	8 channels, voltage
XGF-AC8A	8 channels, current
XGF-AD8A	8 channels, voltage/current
XGF-AD4S	4 channels, voltage/current
XGF-AD16A	16 channels, voltage/current
XGF-AW4S	2-wire, Voltage/ Current input, 4Ch (Isolated)



Analog output module

XGF-DV4A	4 channels, voltage
XGF-DC4A	4 channels, current
XGF-DV8A	8 channels, voltage
XGF-DC8A	8 channels, current
XGF-DV4S	4 channels, voltage, Isolated
XGF-DC4S	4 channels, current, Isolated

Analog input/output module

XGF-AH6A	Input: 4ch, Voltage/ Current Output: 2Ch Voltage/ Current
----------	--

Temperature module



Temperature input module

XGF-TC4S	4 channels, thermocouple input, Isolated
XGF-RD4A	4 channels, RTD input
XGF-RD4S	4 channels, RTD input, Isolated



Temperature controller

XGF-RD8A	8 channels input: RTD
XGF-TC4UD	4 channels input: voltage/current/TC/RTD 8 channels output: current/TR
XGF-TC4RT	4 channels input: RTD 4 channels output: TR Control: 4loop

Positioning module/Motion controller



Positioning module

XGF-P01A-P03A	Open collector, 1~3axis
XGF-PD1A-PD3A	Line drive, 1~3axis
XGF-P01H-P04H	Open collector, 1~4axis
XGF-PD1H-PD4H	Line drive, 1~4axis

Motion module



Motion module

XGF-M32E	Standard EtherCAT Net, 32 axes
----------	--------------------------------

High speed counter module



High-speed counter module

XGF-H02A	2 channels, Open collector
XGF-HD2A	2 channels, Line driver
XGF-H08A	8-channels high speed counter module, 8Ch

Event input module



High-speed counter module

XGF-S0EA	DC24V, 32points
----------	-----------------



Features

- Fast conversion processing
- High resolution
- Setting and monitoring the special module parameter through XG5000
- Supporting 4 types of digital output data format

Specifications

Item	XGF-AV8A (Voltage input)	XGF-AC8A (Current input)	XGF-AD4S (Voltage/Current input)						
No. of input channel	8 channels		4 channels						
Analog input	DC 1-5V, 0-5V, 0-10V, -10-10V	DC 4-20mA, 0-20mA	DC 1-5V, 0-5V, 0-10V, -10-10V DC 4-20mA, 0-20mA						
Digital output	Selection of input range in program or S/W package (Available to be set per channel)								
	XGF-AV8A	Analog input		1-5V	0-5V	0-10V	-10-10V		
		Digital output	Unsigned value		0-16,000				
			Signed value		-8000-8,000				
			Precise value	1,000-5,000	0-5,000	0-10,000	-10,000-10,000		
	Percentile value		0-10,000						
	XGF-AC8A	Analog input		4-20mA		0-20mA			
		Digital output	Unsigned value		0-16,000				
			Signed value		-8,000-8,000				
			Precise value	4,000-20,000		0-20,000			
	Percentile value		0-10,000						
	XGF-AD4S	Analog input		1-5V	0-5V	0-10V	-10-10V	4-20mA	0-20mA
Digital output		Signed value		-32,000-32,000					
		Precise value	1,000-5,000	0-5,000	0-10,000	-10,000-10,000	4,000-20,000	0-20,000	
		Percentile value		0-10,000					
Resolution	1/16,000				1/64,000				
	1-5V	0.250mV	4-20mA	1.0μA	1-5V	62.5μV	4-20mA	250nA	
	0-5V	0.3125mV			0-5V	78.1μV			
	0-10V	0.625mV	0-20mA	1.25μA	0-10V	156.3μV	0-20mA	312.5nA	
-10V-10V	1.250mV	±10V			312.5μV				
Accuracy	±0.2% or less (Ambient temperature 25°C) ±0.3% or less (Range of operation temperature)				±0.05% or less (Ambient temperature 25°C) Temp. coefficient ±16.7ppm/°C (Range of operation temperature)				
Conversion speed	250μs/channel								
Max. absolute input	15V	±30mA		Voltage: ±15V, Current: ±30mA					
Insulation method	Photo-coupler Insulation between input terminal and power supply								
	No insulation between channels				Insulation between channels				
Connection terminal	18 points								
No. of occupied	Fixed type (Setting in basic parameter): 64 points								
I/O points	Variable type (Dissolving in basic parameter): 16 points								
Current consumption	420mA				610mA				
Weight [Kg]	0.14								

Configuration

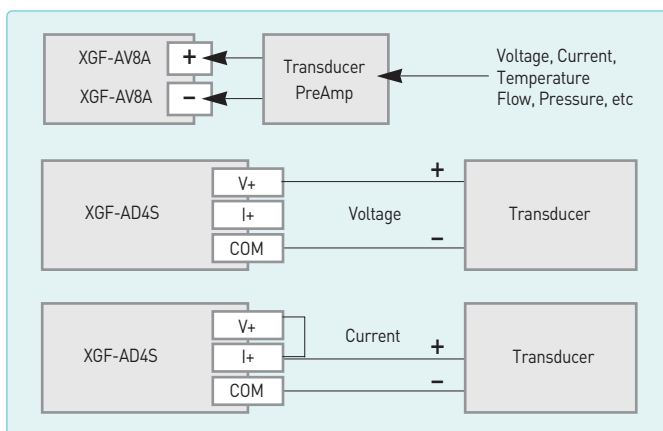

A/D conversion characteristics

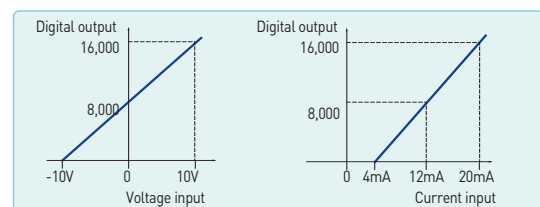

Insulation type

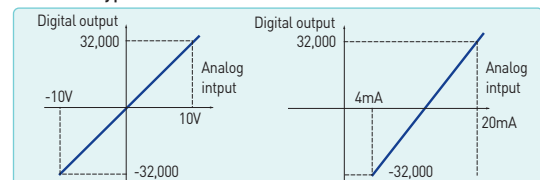

Features

- Fast conversion processing
- High resolution
- Setting and monitoring the special module parameter through XG5000
- Supporting 4 types of digital output data format



Specifications

Item	XGF-AD16A				XGF-AD8A	
No. of input channel	16 channels				8 channels	
Analog input	Voltage input					
	DC 1-5V, DC 0-5V, DC 0-10V, DC -10-10V (Input resistance: 1M Ω)					
	Current input					
	DC 4-20mA, DC 0-20mA (Input resistance: 250 Ω)					
	Dip switch					
Range selection	Selection of input range in the program or S / W package (Available to set per each channel)					
Input type	Voltage input				Current input	
	DC 1-5V	DC 0-5V	DC 0-10V	DC -10-10V	DC 4-20mA	DC 0-20mA
Digital output	Unsigned value					
	0-16,000					
	Signed value					
	-8,000-8,000					
	Precise value					
	0-10,000					
Percentile value	1,000-5,000	0-5,000	0-10,000	-10,000-10,000	4,000-20,000	0-20,000
Resolution(1/16000)	0.2500mV	0.3215mV	0.6250mV	1.250mV	1.00 μ A	1.25 μ A
Range selection	Selection of input type by program or parameter (Available to be set per each channel)					
Resolution	$\pm 0.2\%$ or less (Ambient temperature 25 $^{\circ}$ C), $\pm 0.3\%$ or less (Range of operation temperature)					
Max. absolute input	$\pm 15V$				$\pm 30mA$	
Conversion speed	500 μ s/channels			250 μ s/channels		
Insulation method	Photo-coupler insulation between terminal and power supply					
Terminal	32 points				18 points	
No. of occupied I/O points (XGK)	Fixed type (Setting in basic parameter): 64 points				Variable type (Dissolving in basic parameter): 16 points	
Current consumption	DC 5V : 420mA					
Wight	140g					

Configuration

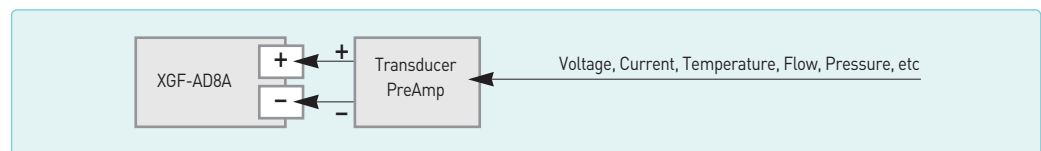

A/D conversion characteristics

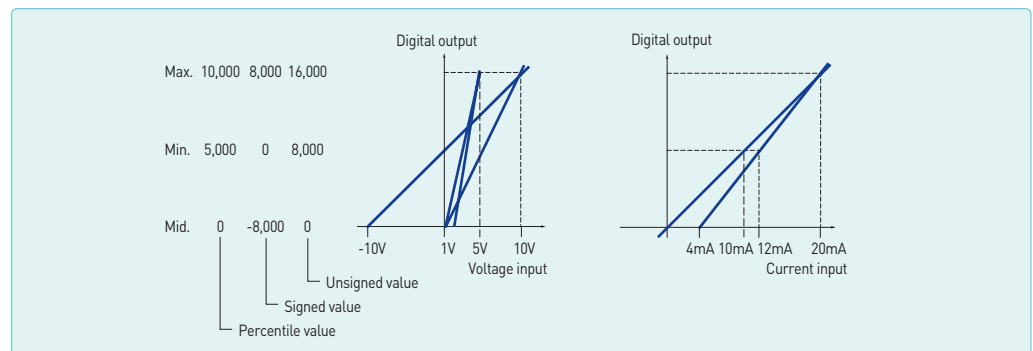

SPECIAL



Features

- 2Wire sensor (transmitter) input
- 1/64000 resolution
- Channel insulation
- Various additional functions

Specifications

Item		XGF-AW4S		
No. of input channel		4channels		
Voltage input		DC 1-5V(Input resistance: 11M Ω)		DC 4-20mA(Input resistance : 250 Ω)
Digital output	Signed value	-32,000-32,000		-32,000-32,000
	Precise value	1,000-5,000		4,000-20,000
	Percentile value	0-10,000		0-10,000
	Resolution(1/64000)	0.25mV		1 μ A
	Range selection	Selection of input range in program or S/W package (Available to be set per channel)		
Resolution		\pm 0.05% or less (Ambient temperature 25 $^{\circ}$ C), Temp. coefficient \pm 70ppm/ $^{\circ}$ C(Range of operation temperature)		
Max. absolute input		\pm 6V		\pm 30mA
Conversion speed		10ms/4channels		
Insulation	Item	Method	Withstand voltage	Resistance
	Channel	Transformer	500VAC, 50/60Hz, 1min, Leakage current: 10mA or less	500VDC, 10M Ω or more
	Terminal - Power	Photo-coupler		
Transmitter	Voltage	DC 24V \pm 15%		
	Max. current	30mA		
	Short circuit protection	Limit current: 25 ~35mA		
External power		DC 24V + 20%, -15%		
Terminal		18 point terminal		
No. of occupied I/O points (XGK)		Fixed type (Setting in basic parameter): 64 points, Variable type (Dissolving in basic parameter): 16 points		
Current	DC 5V	180mA		
consumption	DC 24V	480mA		
Wight		140		

Configuration

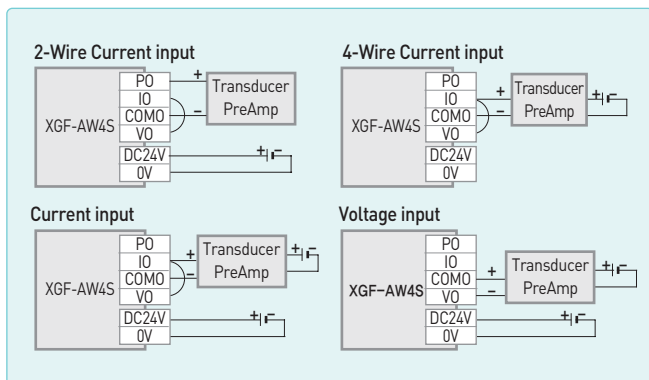

A/D conversion characteristics

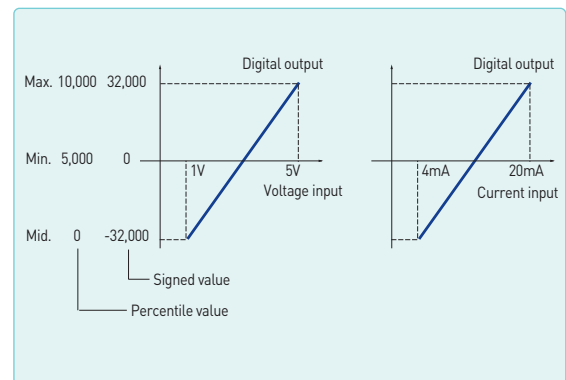

Analog input module(Isolated)

Features

- Channel isolation
- 1/64000 resolution
- $\pm 0.05\%$ (25°C) fixed density
- Setting and monitoring the special module parameter through XG5000



Specifications

Item		XGF-AD4S					
No. of input channel		4 channel					
Analog input	Voltage input	DC 1-5V, DC 0-5V, DC 0-10V, DC -10-10V (Input resistance: 1M Ω)					
	Current input	DC 4-20mA, DC 0-20mA (Input resistance: 250 Ω)					
	Input selection	Dip switch			-		
	Range selection	Selection input range in the program or S/W package(Available to set per each channel)					
	Input type	Voltage input			Current input		
		DC 1-5V	DC 0-5V	DC 0-10V	DC -10-10V	DC 4-20mA	DC 0-20mA
Digital output	Signed value	-32,000-32,000					
	Precise value	0-10,000					
	Percentile value	1,000-5,000	0-5,000	0-10,000	-10,000-10,000	4,000-20,000	0-20,000
	Resolution(1/64,000)	0.0625mV	0.0781mV	0.1563mV	0.3125mV	0.25 μ A	0.3125 μ A
	Range selection	Selection input range in the program or S/W package(Available to set per each channel)					
Resolution	$\pm 0.2\%$ or less(Ambient temperature 25°C), $\pm 0.3\%$ or less(Range of operation temperature)						
Max. absolute input	$\pm 15V$			$\pm 30mA$			
Conversion speed	10ms/4 channel						
Isolation Standards	Item	Isolation Method		Isolation withstand voltage		Isolation resistance	
	Channels	Transformer isolation		500VAC, 50/60Hz		10M Ω or more	
	Input-PLC Power	Photo-coupler isolation					
Terminal	18 points						
No. of occupied I/O points (XGK)	Fixed type(Setting in basic parameter):64points, Variable type(Dissolving in basic parameter): 16points						
Current consumption	DC 5V: 610mA						
Wight	140						



Analog input module (Example)

System Configuration

This is a simple example to start Analog input module setting. For more details, refer to user's manual.

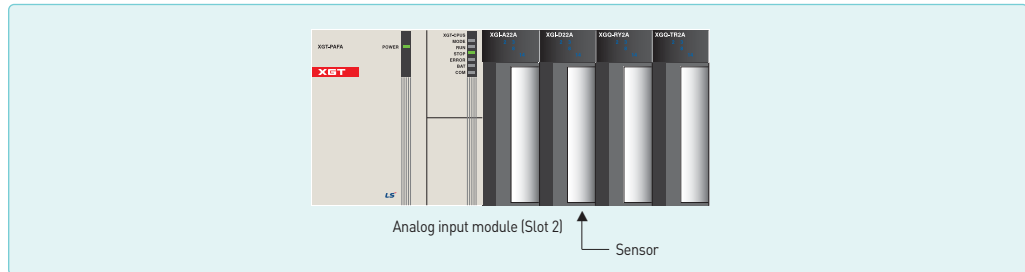

Wiring

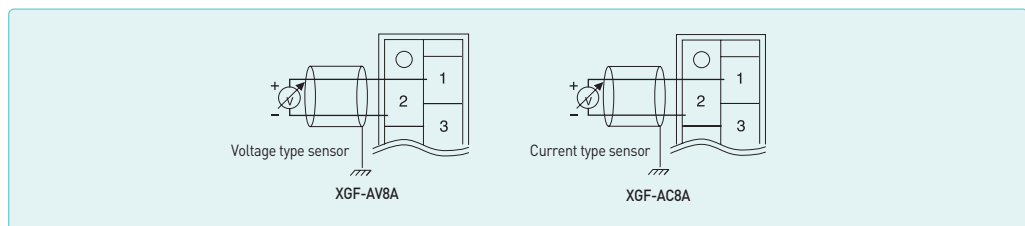

Parameter setting

In the parameter setting box, select slot and analog module that you want to use. (This example shows to select '0' channel of voltage input type.)

XGF-AV8A (Voltage, 8-CH)

XGF-AV8A (Voltage, 8-CH)

Parameter	CH 0
<input type="checkbox"/> Channels	Disable
<input type="checkbox"/> Input Range	1~5V
Output Type	0~16000
<input type="checkbox"/> Filter Process	Disable
Filter Constants	1
<input type="checkbox"/> Average Process	Disable
<input type="checkbox"/> Average Method	Count-Avr
Average Value	2

You need to fill out each item suitable for your system.

Press the <Details> button at lower end of parameter setting box after selecting the module.

Programming

Create a program for A/D conversion (0~10V to 0~16,000).

Special devices for programming

Refer to user's manual for more details.

U02.0.0: Error

U02.11.0: Requesting error-clear

U02.02: Memory of channel A/D value

Uxy.aa.bb
 x: Base number
 y: Slot number
 aa,bb: Refer to user's manual.

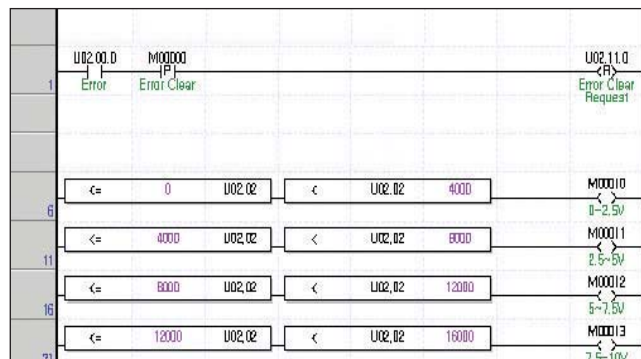

Analog output module



Features

- Fast conversion processing
- High resolution
- Setting and monitoring the special module parameter through XG5000
- Supporting 4 types of digital input data format

Specifications

Item	XGF-DV4A, XGF-DV8A, XGF-DV4S [Voltage output type]	XGF-DC4A, XGF-DC8A, XGF-DC4S [Current output type]					
No. of output channel	XGF-DV4A/4S, XGF-DC4A/4S : 4 channels / XGF-DV8A, XGF-DC8A : 8 channels						
Analog output range	DC 1-5V, 0-5V	DC 4-20mA					
	DC 0-10V, -10-10V	DC 0-20mA					
Selection of input range in the program or S/W package (Available to set per each channel)							
Digital input range	Voltage type						
	Analog output	Digital input	Unsigned value	1-5V	0-5V	0-10V	-10-10V
			Signed value	0-16,000			
			Precise value	1,000-5,000	0-5,000	0-10,000	-10,000-10,000
			Percentile value	0-10,000			
	Analog output	Digital input	Current type		4-20mA	0-20mA	
			Unsigned value	0-16,000			
			Signed value	-8,000-8,000			
			Precise value	4,000-20,000	0-20,000		
	Percentile value	0-10,000					
16-bit binary value: selection of input type by program or parameter (Available to be set per each channel)							
Max. resolution	1/16,000 (Per each input range)						
	1-5V	0.250mV	4-20mA		1.0μA		
	0-5V	0.3125mV					
	0-10V	0.625mV					
	±10V	1.250mV	0-20mA		1.25μA		
Accuracy	XGF-DV4A/8A, DC4A/8A : ±0.2% or less (Ambient temperature 25°C), ±0.3% or less (Range of operation temperature) XGF-DV4S/DC4S : ±0.1% or less (Ambient temperature 25°C), temp coefficient: ±80ppm/°C						
Conversion speed	250μs/channel						
Max. absolute output	±15V			±24mA			
Insulation method	Photo-coupler insulation between terminal and power supply XGF-DV4A/8A, XGF-DC4A/8A: No insulation between channels XGF-DV4S, XGF-DC4S (Insulation type): Insulation between channels						
Connection terminal	18 point terminal						
No. of occupied points	Fixed type (Setting in basic parameter): assign 64 points						
	Variable type (Dissolving in basic parameter): assign 16 points						
Current consumption (mA)		DV4A	DV8A	DV4S	DC4A	DC8A	DC4S
	Internal	190	190	200	190	190	200
External	140	180	150	210	300	220	
Weight (Kg)	0.15						

Output wiring

XGF-DV4A/4S/8A
XGF-DC4A/4S/8A

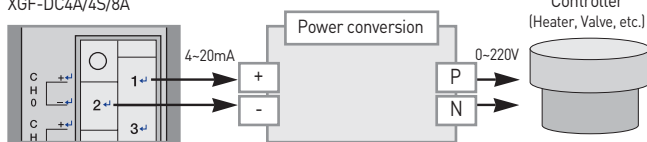

I/O conversion characteristics

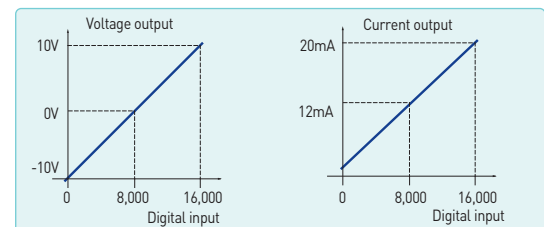

Insulation type

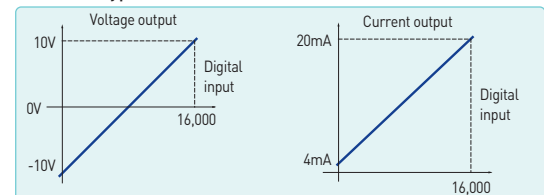

Analog input/output module

Features

- Input 4channels Output 2channels
- 4channels, 1/8000 resolution
- Parameter setting and monitoring by XG5000



Specifications

Item		XGF-AH6A					
Input	No. of input channel	4channels					
	Analog output	Range	DC1-5V	DC0-5V	DC0-10V	DC-10-10V	DC4-20mA
		Resistance	1MΩ				
		Selection	V+ and COM				
	Digital output	Unsigned value	0-8,000				0-8,000
		Signed value	-4,000-4,000				-4,000-4,000
		Precise value	0-10,000				
		Percentile value	1,000-5,000	0-5,000	0-10,000	-10,000-10,000	4,000-20,000
		Resolution(1/8000)	0.5mV	0.625mV	1.25mV	2.5mV	2.0uA
	Range selection	Selection of input range in program or S/W package (Available to be set per channel)					
	Resolution	±0.2% or less (Ambient temperature 25°C), ±0.3% or less (Range of operation temperature)					
	Max. absolute input	±15V				±30mA	
Conversion speed	500ms/channels						
Output	No. of input channel	2channels					
	Analog output	Range	DC1-5V	DC0-5V	DC0-10V	DC-10-10V	DC4-20mA
		Resistance	1kΩ or more				
		Selection	V+ and COM				
	Digital output	Unsigned value	0-8,000				0-8,000
		Signed value	-4,000-4,000				-4,000-4,000
		Precise value	0-10,000				
		Percentile value	1,000-5,000	0-5,000	0-10,000	-10,000-10,000	4,000-20,000
		Resolution(1/8000)	0.5mV	0.625mV	1.25mV	2.5mV	2.0uA
	Range selection	Selection of input range in program or S/W package (Available to be set per channel)					
	Resolution	±0.2% or less (Ambient temperature 25°C), ±0.3% or less (Range of operation temperature)					
	Max. absolute input	±15V				±24mA	
Conversion speed	500us/channels						
Insulation method	Photo-coupler insulation between terminal and power supply						
Terminal	18 point terminal						
No. of occupied I/O points (XGK)	Fixed type (Setting in basic parameter): 64 points, Variable type (Dissolving in basic parameter): 16 points						
Current consumption (DC5V)	770mA						
Wight	140						

Wiring

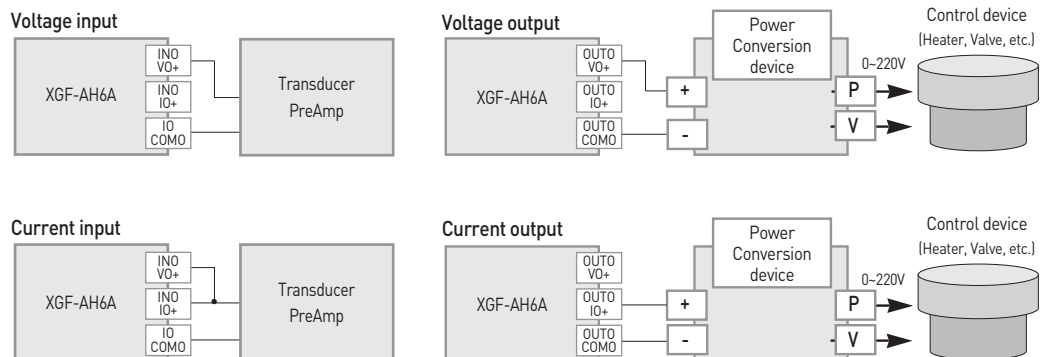

SPECIAL

Features

- It supports HART protocol
In the input range of 4 ~ 20mA, bi-directional digital communication is available by using analog signal wiring. If analog wiring is currently used, there is no need to add wiring for HART communication (HART communication is not supported in the range of 0 ~ 20mA)
- High accuracy
- Operation parameters setting/monitoring
- Input disconnection detection function



Specifications

Item		XGF-AC4H		XGF-DC4H	
No. of Channels		4channels		4channels	
Analog input/output range		DC4~20mA,DC 0~20mA, (Input Resistance 250Ω)		DC 4~20mA,DC 0~20mA, (Load resistance 600Ω or less)	
Digital input/output	Analog output/Digital input	DC4~20mA	DC0~20mA	DC4~20mA	DC0~20mA
	Signed value	-32000~32000		-8000~8000	
	Unsigned value	-		0~1600	
	Precise value	4000~2000	0~2000	4000~2000	0~2000
Percentile value		0~10000			
Max. resolution		0 / 64000		0 / 64000	
		4~20mA:250.0nA, 0~20mA:312.5nA		4~20mA:1.00nA, 0~20mA:1.25nA	
Accuracy		±0.10% or less (when ambient temperature is 25°C±5°C)		±0.10% or less (when ambient temperature is 25°C±5°C)	
		±0.25% or less (when ambient temperature is 0°C~55°C)		±0.3% or less (when ambient temperature is 0°C~55°C)	
Conversion speed		10ms/4channels			
Absolute Max. input/output		±3mA		DC 24mA	
Analog input points		4 channels / 1module			
Isolation specification		Photo-coupler isolation between input terminal and PLC power (no isolation between channels)			
Terminal connected		18-point terminal			
I/O points occupied		Fixed type: 64 points, Non fixed type : 16 points			
HART communication method		Mono drop only Primary master only			
Internal-consumed current		DC5V:340mA		DC5V:200mA, DC24V:220mA	
Weight (g)		145		150	

Features

- Parameter setting and monitoring using XG5000
- Incremental encoder available
- Supporting various pulse input (5V, 12V, 24V)
- Various multiplication (1/2 phase pulse input)
- External present input
- Providing function to prevent from counting external signal
- Supporting HTL-level incremental encoder in the line-drive input type



Specifications

Item		XGF-H02A			XGF-HD2A
No. of command	Signal	A Phase, B Phase			
	Input type	Voltage input (Open Collector)			Differential input (Line Driver)
	Signal level	DC 5/12/24V			RS-422 Line Drive/HTL LEVEL Line Drive
	Input voltage	24V DC (17.0V ~ 26.4V)	12V DC (9.8V ~ 13.2V)	5V DC (4.5V ~ 5.5V)	Line Driver
	Input current	7~11mA	7~11mA	7~11mA	RS-422 Line Drive HTL Level Line Drive
	Min. On guaranteed voltage	17.0V	9.8V	4.5V	
	Max. Off guaranteed voltage	4.5V	3.0V	1.7V	
Counter enable	Set by program (Count only in 'Enable')				
Max. counting speed	200Kpps			500Kpps (HTL input: 250Kpps)	
No. of channels	2 channels				
Counting range	Signed 32 Bit (-2,147,483,647 ~ 2,147,483,647)				
Counting type (Program setting)	Linear count (Generating Carry/Borrow when exceeding counting range, Max/Min value)				
Input mode (Program setting)	1 Phase input				
	2 Phase input				
	CW/CCW input				
Signal type	Voltage				
Up/Down counter setting	1-phase input	Program or B-phase			
	2-phase input	Phase difference			
	CW/CCW	A-phase input: Up count B-phase input: Down count			
Multiplication	1-phase input	1/2 multiplication (Programming)			
	2-phase input	1/2/4 multiplication (Programming)			
	CW/CCW	1 multiplication			
Control input	Signal	Preset signal, Signal to admit additional signal (Setting by terminal block or programming)			
	Signal level	DC 5V/12V/24V input type (Selecting terminal)			
	Signal type	Voltage			
External output	No. of output point	2 points/channel: Terminal output available			
	Type	Single comparison (>,>=,<=<) or section comparison			
	Output type	Open Collector (Sink)			
Operating status display	Input signal	A-phase, B-phase, Preset signal, Signal to admit additional signal			
	Output signal	OUT1, OUT2			
	Operation status	Module Ready, Pulse input status of A, B phase			
Addition functions (Program setting)	<ul style="list-style-type: none"> • Count clear, Count latch • Section count (Set time value:1~60000ms) • Measuring counting number per a unit time (Set time value:1~60000ms) • Preventing from counting (Setting by internal/external input during counting) 				
No. of occupied	Fixed type (Setting in basic parameter): 64 points				
I/O points	Variable type (Dissolving in basic parameter): 16 points				
Terminal block	40-pin connector				
Current consumption	270			330	
Weight (Kg)	0.09				

Terminal block configuration

XGF-H02A

Pin layout	Pin number		Signal name	
	CH0	CH1		
<p>The diagram shows a terminal block with 40 pins. Pins 1-16 are grouped into two channels: CH0 (pins 1-16) and CH1 (pins 17-32). Each channel has inputs for A phase (A12V, A24V, A5V), B phase (B12V, B24V, B5V), Preset (P12V, P24V, P5V), and Gate (G12V, G24V, G5V). Pins 33-36 are comparison outputs (OUT1, OUT0). Pins 37-38 are for external power supply (24V), and pins 39-40 are for DC24V.</p>	1	17	A12V	A phase DC12V input
	2	18	A24V	A phase DC24V input
	3	19	A_C	A phase COM
	4	20	A5V	A phase DC5V input
	5	21	B12V	B phase DC12V input
	6	22	B24V	B phase DC24V input
	7	23	B_C	B phase COM
	8	24	B5V	B phase DC5V input
	9	25	P12V	Preset DC12V input
	10	26	P24V	Preset DC24V input
	11	27	P_C	Preset COM
	12	28	P5V	Preset DC5V input
	13	29	G12V	Gate DC12V input
	14	30	G24V	Gate DC24V input
	15	31	G_C	Gate COM
	16	32	G5V	Gate DC5V input
	33	35	OUT1	Comparison output OUT1
	34	36	OUT0	Comparison output OUT0
	37	38	24V	External power supply
	39	40	24G	DC24V

Configuration

CPU	Setting preset value	H02A/HD2A
	Setting set value	CH0
	Writing operation status	CH0
	Counter admission, Reset, Output admission	CH0
	Reading operation status	CH1
	Reading counting value	CH1

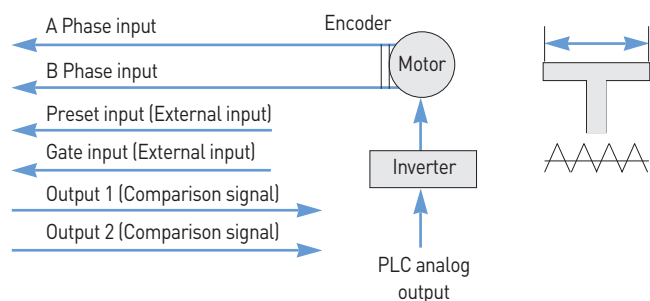

XGF-HD2A

Pin layout	Pin number		Signal name	
	CH0	CH1		
	1	17	AI-	AI-Input (LINEDRIVETTL LEVEL Input)
	2	18	AI+	AI+Input (LINEDRIVETTL LEVEL Input)
	3	19	AII-	AII-Input (LINE DRIVEHTL LEVEL Input)
	4	20	AII+	AII+Input (LINEDRIVEHTL LEVEL Input)
	5	21	BI-	BI- Input (LINEDRIVETTL LEVEL Input)
	6	22	BI+	BI+Input (LINE DRIVETTL LEVEL Input)
	7	23	BII-	BII-Input (LINEDRIVEHTL LEVEL Input)
	8	24	BII+	BII+Input (LINEDRIVEHTL LEVEL Input)
	9	25	P12V	Preset DC12V input
	10	26	P24V	Preset DC24V input
	11	27	P_C	Preset COM
	12	28	P5V	Preset DC5V input
	13	29	G12V	Gate DC12V input
	14	30	G24V	Gate DC24V input
	15	31	G_C	Gate COM
	16	32	G5V	Gate DC5V input
	33	35	OUT1	Comparison output OUT1
	34	36	OUT0	Comparison output OUT0
	37	38	24V	External power supply
	39	40	24G	DC24V

Configuration

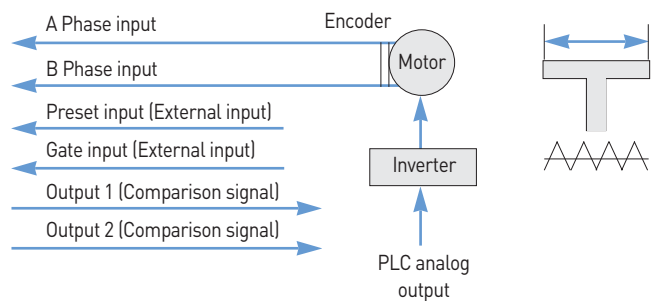
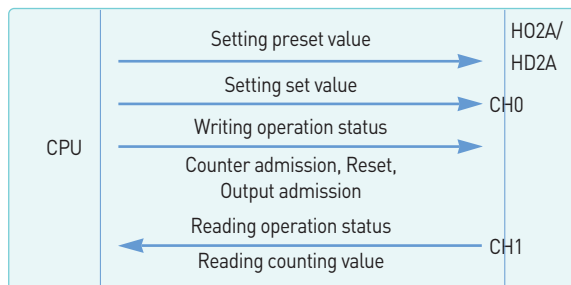

Features

- Multiple high-speed counter input support(8ch, 80-pin connector)
- Only improve performance and safety caused by the use of FPGA enhanced
- Program controlled by the preset function
- Per 1 channel output 1 point(Program setting)
- Input filter can be set (100kpps, 10kpps, 1kpps, 0.1kpps)
- The output signal through the operation status display



Specifications

Item		XGF-H08A
No. of Channels		8 channels
Phase		1-phase input, 2-phase input
Signal level		5V DC (7 to 11mA), 24V DC (7 to 11mA)
Input type		1/2/4 multiplication, CW/CCW
Max. counting speed		200 kpps
Input filter		None, 100kpps, 10kpps, 1kpps, 0.1kpps
Counting range		Signed 32bit (-2147483648 ~ 2147483647)
Counting type		Linear counter, Ring counter
Up/Down Counter setting	1-phase input	B-phase : Up/Down count
	2-phase input	Phase difference
	CW/CCW	A-phase : Up count, B-phase : Down count
Multiplication	1-phase input	1/2 multiplication(Programming)
	2-phase input	1/2/4 multiplication(Programming)
	CW/CCW	1 multiplication
External output	Comparison detection	Single comparison(→,→=,=←,←) or Section comparison
	Output points	1 point/channels : Internal or External output (programming)
	type	Open collector output(Sink)
Operating status display	Input signal	A-phase, B-phase
	Output signal	OUT
	Operating condition	Module ready
Addition functions(Program setting)		Counter clear, Count latch
		Section count(Set time value : 1 ~ 60000ms)
		Pulse frequency(Each input channel)
		Measuring counting number per a unit time (Set time value : 1 ~ 60000ms)
		Preventing from counting
Power		DC5V (600mA)
Terminal block		80-pin connector

This is a simple example of high-speed counter module setting.
For more details, refer to user's manual.

System Configuration

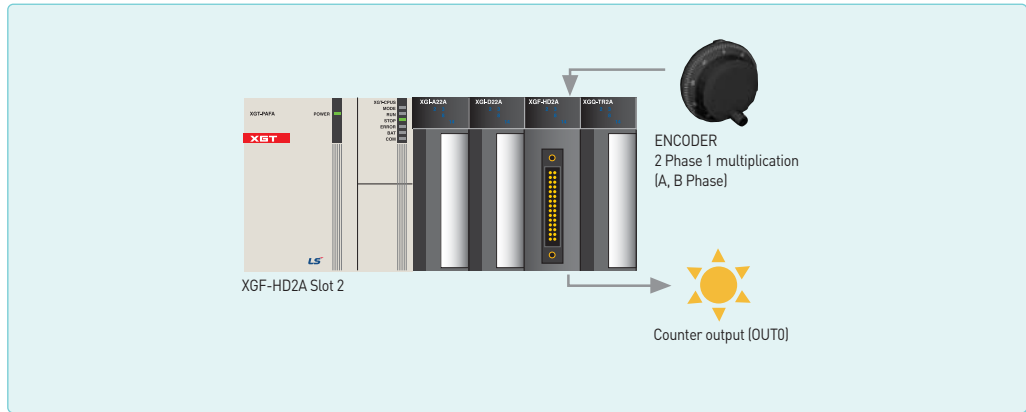

Wiring

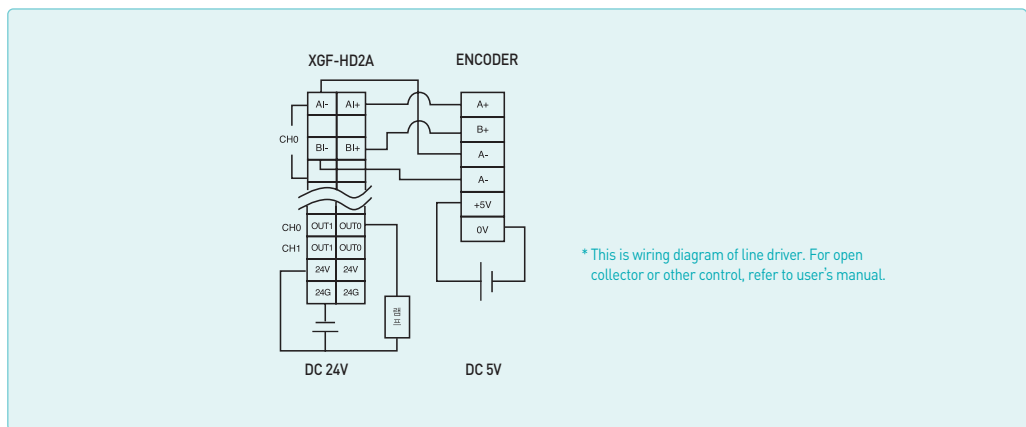

Control configuration

- Light a lamp of output when present value reaches 1000 of pulse input counted by encoder.
- Current value of pulse is saved in D100-D101 and is monitored.

Module test (Online)

- Module test function of XGT enables to monitor operation status of high-speed counter module and to test-run.

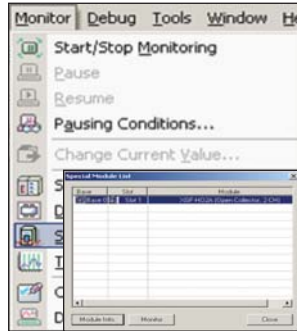

Select [Monitor] → [Special Module Monitoring] in menu and appoint high-speed counter.



After pressing the button for [Start Monitoring], press the button [FLAG monitor].

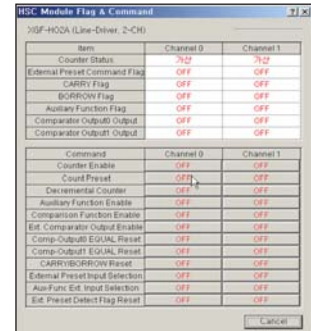

Change [Counter Enable] status to ON.

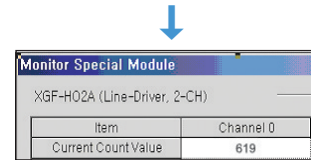

Check current counting value in 'Monitor Special Module' screen box.

Parameter setting

- In I/O parameter setting box, select slot and analog module that you want to use. (This example shows to select 2-channel line driver.)

Press the <Details> button at lower end of parameter setting box after selecting the module.

Input 1000 as Max. and Min. comparison output.

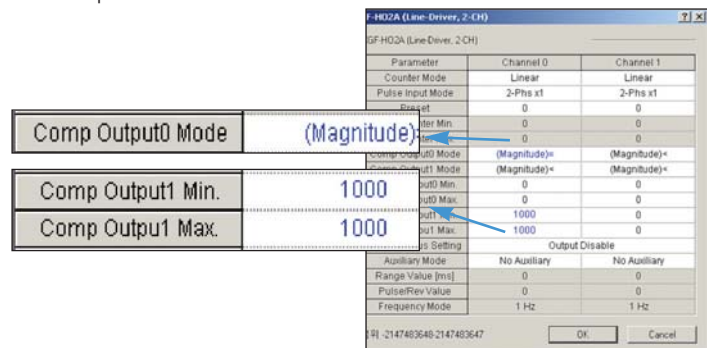
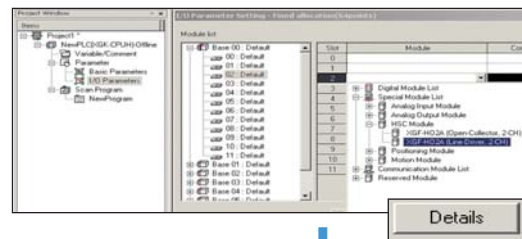

programming

- After completing programming like following figure, download it to PLC and check operation status.

Special devices for programming

Refer to user's manual for more details.

U02.23.0: Count operation admission

U02.23.1: Count preset

U02.23.4: Consistent output admission

U02.23.5: Output external terminal admission

U02.23.6: OUT0 consistent signal reset

U02.00.6: Contact for checking external output
(Practically effective output is
outputted through OUT0 terminal)

U02.02-U02.03: Counter present value

Uxy.aa.bb
x: Base number
y: Slot number
aa,bb: Refer to user's
manual

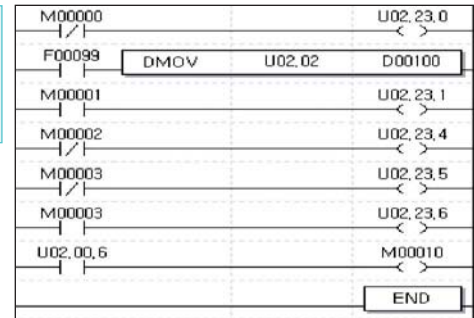

After downloading, monitor operation status.

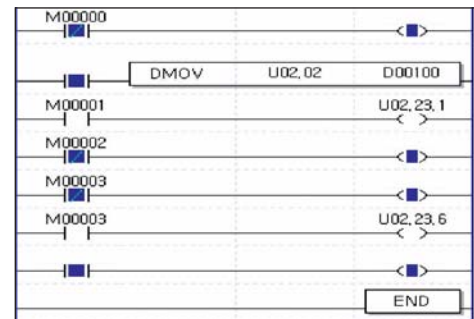

For monitoring just present value, follow the example.

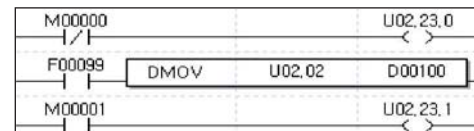

Features

- Max 4Axis, Max pulse output 4Mpps
- Circular/linear/ellipse/helical interpolation
- Asymmetric acceleration and deceleration driving
- FRAM parameter
- XG5000 monitoring, simulation, trace
- CAM profile program



Specifications

Item		XGF-P01H XGF-PD1H	XGF-P02H XGF-PD2H	XGF-P03H XGF-PD3H	XGF-P04H XGF-PD4H
Number of axis		1 axis	2 axis	3 axis	4 axis
Interpolation		—	Circular, linear, ellipse	Circular, linear, helical, ellipse	
Control method		Position control, speed control, speed/position control, position/speed control, FEED			
Positioning data		Each axis has 400 data items (Operation step number 1~400). It is available to set with XG5000 or programming.			
Configuration Tool		XG5000 (Connected with USB or RS-232C Port of CPU module)			
Data backup		FRAM (Parameter, Operation data), Flash memory (CAM Data), No battery			
Pulse output		XGF-P0xH: Open collector, XGF-PDxH: line driver			
Positioning	Positioning method		Absolute / Incremental		
	Position address range	mm	-214,748,364.8 ~ 214,748,364.7(μm)		
		inch	-21,474.83648 ~ 21,474.83647		
		degree	-21,474.83648 ~ 21,474.83647		
		pulse	-2,147,483,648 ~ 2,147,483,647		
	Position address speed	mm	0.01 ~ 20,000,000.00(mm/min)		
		inch	0.001 ~ 2,000,000.000(inch/min)		
		degree	0.001 ~ 2,000,000.000(degree/min)		
		pulse	1 ~ 500,000(pulse/sec): Open collector, 1 ~ 4,000,000(pulse/sec): line driver		
		RPM	0.1 ~ 100,000.0(RPM)		
Accel/Decel pattern		Trapezoidal & S-curve acceleration/deceleration			
Accel/Decel time		0~2,147,483,647ms			
Max. output pulse		Open collector: 500kpps, line driver: 4Mpps			
Max. distance		Open collector: 5m, line driver: 10m			
Max. encoder input		500kpps			
Error display		LED			
Size of cable		AWG #24			
Occupied points of I/O		64 points (Fixed type), 16 points (Variable type)			
Connection connector		40Pin		80Pin	
Current consumption (mA)		XGF-P01H:400mA	XGF-P02H:410mA	XGF-P03H:420mA	XGF-P04H:430mA
		XGF-PD1H:520mA	XGF-PD2H:600mA	XGF-PD3H:850mA	XGF-PD4H:890mA
Weight (kg)		120		130	

Terminal block configuration

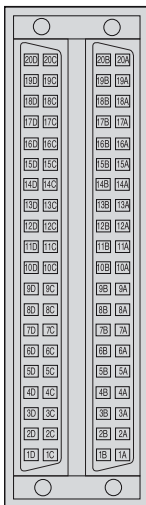

Pin number				Signal name	Remarks
AX1	AX2	AX3	AX4		
20A				MPG A+	Manual pulse generntor /Encoder A+ input
20B				MPG A-	Manual pulse generntor /Encoder A- input
19A				MPG B+	Manual pulse generntor /Encoder B+ input
19B				MPG B-	Manual pulse generntor /Encoder B- input
20C, 19C, 20D, 19D				NC	Not used
18A	18B	18C	18D	FP+	Foward pulse (‡)
17A	17B	17C	17D	FP-	Foward COM (-)
16A	16B	16C	16D	RP+	Backward pulse (‡)
15A	15B	15C	15D	RP-	Backward COM (-)
14A	14B	14C	14D	OV+	Max. signal
13A	13B	13C	13D	OV-	Min. signal
12A	12B	12C	12D	DOG	Approximate orgin signal
11A	11B	11C	11D	EMG	Emergency stop
				STOP	External stop signal
10A	10B	10C	10D	VTP	Speed / Position switching signal
9A	9B	9C	9D	COM	Common (OV+,OV-,DOG,EMG,STOP,VTP)
8A	8B	8C	8D	DR	Drive ready signal
7A	7B	7C	7D	INP	In-position
6A	6B	6C	6D	DR/INP COM	Drive ready/ In-position Common
5A	5B	5C	5D	CLR	Deviation counter clear signal
4A	4B	4C	4D	CLR COM	Deviation counter clear signal Common
3A	3B	3C	3D	HOME +5V	Zero signal (+5V)
2A	2B	2C	2D	HOME COM	Zero signal (+5V) Common
1A, 1C				+24V	+24V
1B, 1D				+24V COM	+24V GND

* Open collector type module : +24V (1A/1C: 24V, 1B/1D: 0V)

Features

- XGF-PN8A : Dedicated LS ELECTRIC EtherCAT Network Support (XGT Servo N series)
- XGF-PN8B : Standard EtherCAT Network Support(Standard EtherCAT Servo)
- Direct connect with servo driver Max 8
- 2~8 axis linear interpolation, 2axis circular interpolation, 3axis helical interpolation
- Position, speed, feed control is possible through the various operation
- Parameters, the operation data stored in the FRAM(without Battery)
- CAM for controlling up to eight different types of CAM data



Specifications

Item		XGF-PN8A/PN8B	XGF-PN4B		
Number of axis		8 axis	4 axis		
Interpolation		2~8 axis linear, 2axis circular, 3axis helical interpolation			
Control method		Position, speed, Speed/position, position/speed position/torque, Feed control			
Setting unit		pulse, mm, inch, degree			
Positioning data		Each axis has 400 data items (Operation step number 1~400). It is available to set with software package or programming.			
XG5000	Port	RS-232C, USB			
	Data	Basic, expansion, manual, servo parameter, operation data, cam data, command information			
	Monitor	Operation, trace, input sort, error information			
Back-up		FRAM(parameter, operation data) no battery			
Positioning	Positoning method	Absolute/Incremental			
	Position address range		Absolute	Incremental	Speed/position, position/speed conversion control
		mm	-214748364.8 ~ 214748364.7(μm)	-214748364.8 ~ 214748364.7(μm)	-214748364.8 ~ 214748364.7(μm)
		inch	-21474.83648 ~ 21474.83647	-21474.83648 ~ 21474.83647	-21474.83648 ~ 21474.83647
		degree	-21474.83648 ~ 21474.83647	-21474.83648 ~ 21474.83647	-21474.83648 ~ 21474.83647
	Position speed range	pulse	-2147483648 ~ 2147483647	-2147483648 ~ 2147483647	-2147483648 ~ 2147483647
		mm	0.01 ~ 2000000.00(mm/Min)		
		inch	0.001 ~ 200000.000(inch/Min)		
degree		0.001 ~ 200000.000(degree/Min)			
Accel/Decel pattern	pulse	1 ~ 20.000.000(pulse/Sec)			
	RPM	0.1 ~ 10000.0(RPM)			
Accel/Decel time		Trapezoidal & S-curve acceleration/deceleration			
Manual		1~2.147.483.647 ms			
Homing method		Jog/MPG/ inching			
The ability to Change speed		Max+Z(Forward), Min+Z(Backward), Near-point+Z(Forward, Backward), Max+near-point+Z(Forward), Min+near-point+Z(Backward), Z(Forward, Backward), near-point(Forward, Backward)			
Torque		Absolute/Percent			
Absolute position System		Rated torque %			
Encoder input		0 (Absolute encoder type servo)			
Encoder input	Channel	2 Channel			
	Max. Input	Max. 200 Kpps			
	Input method	line-drive input(RS-422A IEC), open collector output type			
	Type	CW/CCW, Pulse/Dir, Phase A/B			
Communication Cycle		Connector			
Max. distance		12 Pin connector			
Cable		800 μs			
Error display		100 m			
Operation display		STP(Shielded Twisted pair) cable			
Occupied points of I/O		LED			
Current consumption (mA)		LED			
Weight(kg)		64points(Fixed type), 16points(Variable type)			
		500 mA			
		115 g			

Terminal block configuration

Pin layout	Pin Number	Signal name	
ENC1A+	1	ENC1A+	Encoder1 A +input
ENC1A-	2	ENC1A-	Encoder1 A - input
ENC1B+	3	ENC1B+	Encoder1 B +input
ENC1B-	4	ENC1B-	Encoder1 B - input
ENC1Z+	5	ENC1Z+	Encoder1 Z +input
ENC1Z-	6	ENC1Z-	Encoder1 Z - input
ENC2A+	7	ENC2A+	Encoder2 A +input
ENC2A-	8	ENC2A-	Encoder2 A - input
ENC2B+	9	ENC2B+	Encoder2 B +input
ENC2B-	10	ENC2B-	Encoder2 B - input
ENC2Z+	11	ENC2Z+	Encoder2 Z +input
ENC2Z-	12	ENC2Z-	Encoder2 Z - input

External encoder wiring

	Pin Number	Signal	
<p>* Open collector type</p>	1	ENC1A+	Encoder1 A +input
	2	ENC1A-	Encoder1 A - input
	3	ENC1B+	Encoder1 B +input
	4	ENC1B-	Encoder1 B - input
	5	ENC1Z+	Encoder1 Z +input
	6	ENC1Z-	Encoder1 Z - input
<p>* line-drive type</p>	7	ENC2A+	Encoder2 A +input
	8	ENC2A-	Encoder2 A - input
	9	ENC2B+	Encoder2 B +input
	10	ENC2B-	Encoder2 B - input
	11	ENC2Z+	Encoder2 Z +input
	12	ENC2Z-	Encoder2 Z - input



Features

- Configuration tool with updated APM software package
- All models can be used for XGT Positioning module (APM, XPM)
- Simultaneous communications can be accessed with XG5000
- Powerful simulation, trace, monitoring

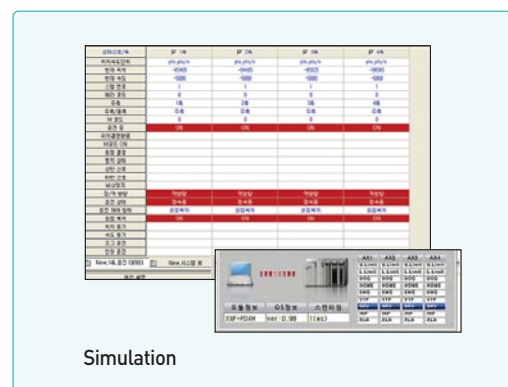
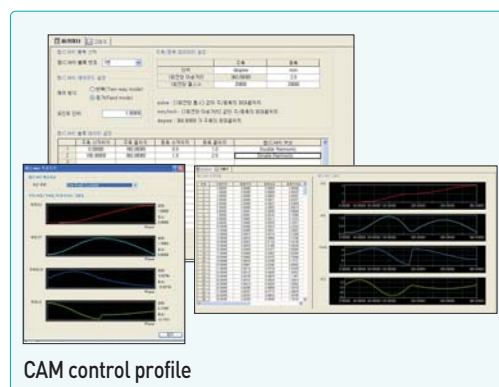
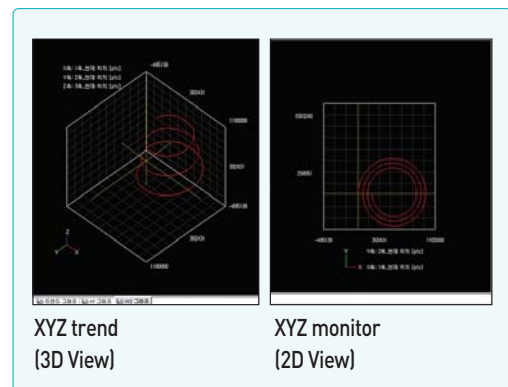
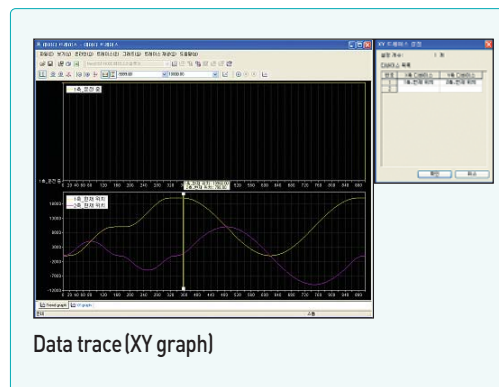
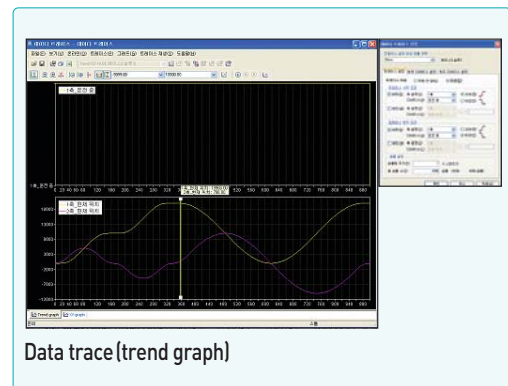
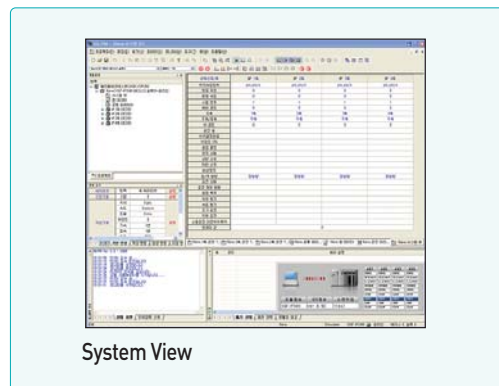

Motion Module[EtherCAT]

Features

- 32 axes (master) and 4 axes (virtual) control
- EtherCAT CoE supported servo drive
- Communication cycle : 1ms
- Built-in DI/DO 8 points each and EtherCAT I/O 512 points
- Program 2MB
- External encoder input 2ch (line drive)
- Max. transmission distance : 100m



Specifications

Item		XGF-M32E
Communication		EtherCAT (CoE : CANopen over EtherCAT)
Number of axis	Real	32 axes
	Virtual	4axes
	I/O	Input/output 8 points each (built-in) EtherCAT I/O connection available
Control period		1ms, 2ms, 4ms (same as main task period)
Control unit		Pulse, mm, inch, degree
I/O	Internal	Input 8 points, output 8 points
	External	EtherCAT I/O 4 ea(max. 256 points)
Motion Program	No. of program	Max. 256 ea
	Capacity	Max. 2Mbyte
	Language	LD(FB), ST
	Position data	6400 points/all aixs
Control method		Position, Velocity, Torque(Servo drivers support) control, Synchronous control, Interpolation control
Range of position/velocity		\pm LREAL, 0
Acc. Dec. process		Trapezoid type, S-type (Setting to specify the Jerk at function block)
Acc. Dec. time		1 ~ 2, 147, 483, 647ms
Manual operation		JOG operation
Torque unit		Rated torque % designation
Encoder input	Channel	2 chennels
	Max. input	Max. 500Kpps
	Input method	Line drive input (RS-422A IEC specification) Open collector output type encoder
	Input type	CW/CCW, Pulse/Dir, Phase A/B
Max. distance		100m
Communication cable		Over CAT.5 STP(Shielded Twisted-pair) cable
Error indication		Indicated by LED
Communication status indication		Indicated by LED
Occupied point I/O		Variable: 16 point, Fixed: 64 point
Communication physical layer		100BASE-TX
Consumable current(mA)		900mA
Weight		122g

System Configuration

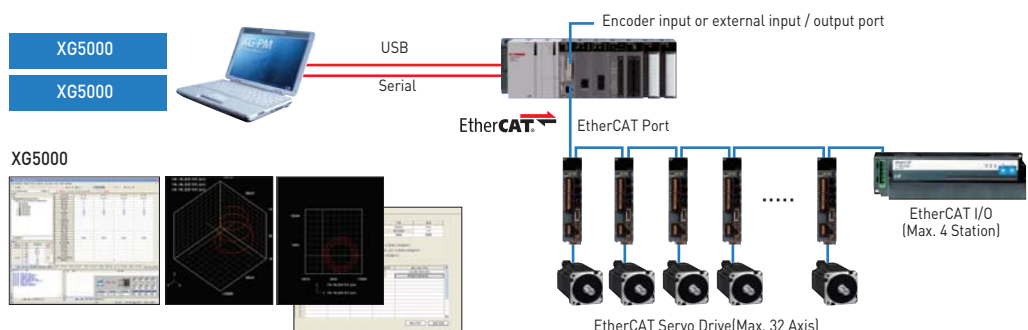



Features

- Supports various additional functions (average, alarm, filter)
- Special module parameter setting and monitoring with XG5000
- Supports digital conversion, temperature display and user scaling
- Support Offset/Gain function(only RD8A)

Specifications

Item		XGF-RD4A	XGF-RD4S	XGF-RD8A	
No. of input channel		4 channels	4 channels	8 channels	
Input sensor type	Pt100	JIS C1604-1997	JIS C1604-1997	JIS C1604-1997	
	JPt100	JIS C1604-1981, KS C1603-1991	JIS C1604-1981, KS C1603-1991	JIS C1604-1981, KS C1603-1991	
	PT1000	-	JIS C1604-1997	-	
	NI100	-	DIN 43760-1987	-	
Temperature input range	Pt100	-200.0 ~ 850.0°C	-200.0 ~ 850.0°C	-200.0 ~ 850.0°C	
	JPt100	-200.0 ~ 640.0°C	-200.0 ~ 640.0°C	-200.0 ~ 640.0°C	
	PT1000	-	-200.0 ~ 850.0°C	-	
	NI100	-	-60.0 ~ 180.0°C	-	
Digital output	Temperature display (unit: 0.1)	Pt100	-2,000 ~ 8,500	-2,000 ~ 8,500	-2,000 ~ 8,500
		JPt100	-2,000 ~ 6,400	-2,000 ~ 6,400	-2,000 ~ 6,400
		PT1000	-	-2,000 ~ 8,500	-
		NI100	-	-2,000 ~ 1,800	-
	Scaling display (Customize)	0 ~ 65535 -32768 ~ 32767			
Accuracy	Normal temp.(25°C)	±0.2%	±0.1%	±0.2%	
	Full temp.(0~55°C)	±0.3%	±70ppm/°C	±0.3%	
Conversion speed		40ms / channel			
Insulation	Channel to Channel	Non-insulation	Insulation	Non-insulation	
	Terminal to PLC Power	Photo-coupler			
Wiring method		3-wire	4-wire	3-wire	
Function	Average	Time average (320~6400ms)			
		Counting average(2~6400 count)			
		Moving average(2~100 samples)			
	Alarm	Process alarm			
		Input changing rate alarm			
Disconnection detection					
Offset / Gain	-	-	0		
Filtering	Digital filter (160~6400ms)				
Terminal block		18-point terminal block			
Current consumption		5V: 450mA	5V: 780mA	5V: 780mA	
Weight [g]		150g			

Characteristics of temperature conversion

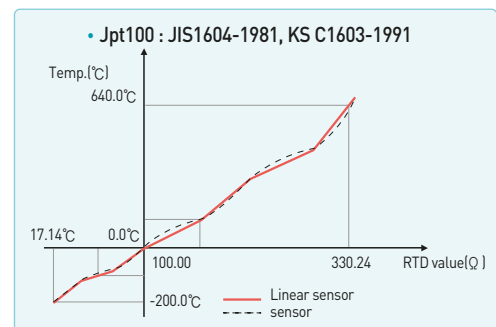
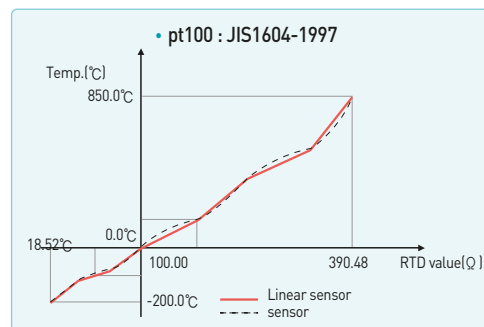

Wiring

• Connection with 2-Wire type sensor

• Connection with 3-Wire type sensor

• Connection with 4-Wire type sensor

1) When sensor and compensating wire are shielded, shield-connection to FG terminal of the module is available.
 2) The wiring of 4-wire type sensor is identical with the wiring of 3-wire type sensor. 3 wires is connected to the module. But the other wire is not connected with the module.

Thermocouple module



Features

- Insulation between channels
- $\pm 0.1\%$ (25°C) constant density
- Supports various input sensor (supporting C-type sensor)
- Various additional functions (average, filter, alarm, max/min value display)
- Special module parameter setting and monitoring with XG5000

Specifications

Item	XGF-TC4S	
Input channels	4 channels	
Input sensor type	K, J, E, T, B, R, S, N, C	JIS C1602-1995ITS-90
Input temperature range	K	-250 ~ 1350°C
	J	-200 ~ 1200°C
	E	-250 ~ 1000°C
	T	-250 ~ 400°C
	B	400 ~ 1800°C
	R	-50 ~ 1750°C
	S	-50 ~ 1750°C
	C	0 ~ 2300°C
Digital output	Temperature display (unit: 0.1)	Display down to the first decimal place (0.1°C)
	Scaling	0 ~ 65535
	(User range setting)	-32768 ~ 32767
Accuracy	Normal temp. (25°C)	$\pm 0.1\%$
	Temperature coefficient (Operating temp. range)	Some section can permit 0.5% $\pm 100\text{ppm}/^\circ\text{C}$
Conversion speed	40ms/ channel	
Insulation	Between channels Insulation	
	Between terminals and power	Insulation(Photo-Coupler)
Compensation	Automatic compensation by RJC sensing (PT100)	
	Compensation degree	$\pm 1.0\%$
Function	Average	Average time (320 ~ 6400ms)
		Average number (2 ~ 64000)
		Average move (2 ~ 100)
	Alarm	Process Alarm
		Change rate alarm
Filter	Digital filter (160 ~ 64000ms)	
Max./Min. values display	Max./Min. values display	
Terminal block	18-point terminal block	
Current consumption	5V : 610mA	
Weight (kg)	0.150	

Input wiring

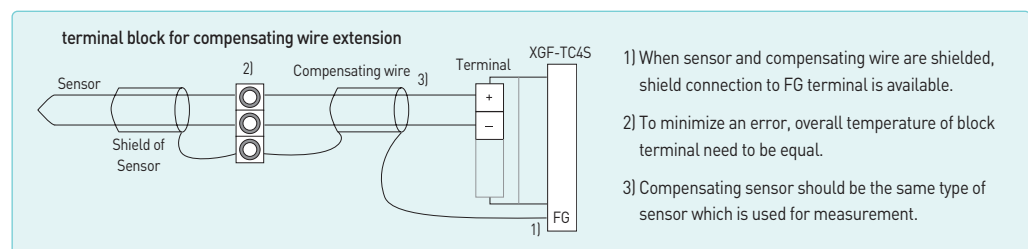

Characteristics of I/O conversion

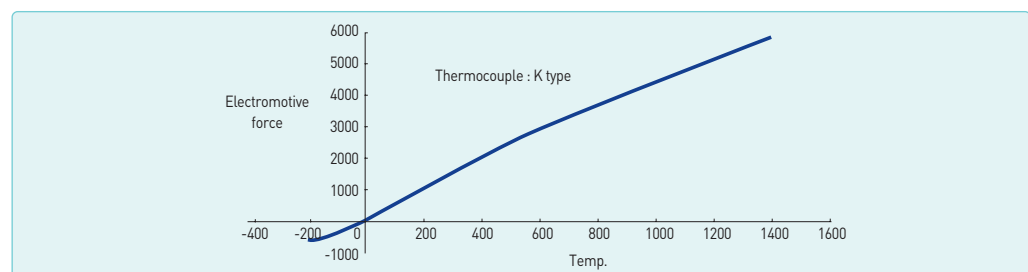

SPECIAL

Features

XGF-TC4UD

- Optimum temperature control
- Universal input: TC, RTD, Voltage, Current
- Isolated input
- Output: Current/Transistor
- Parameter setting via dedicated software: TG-CON
- Variety of control types
 - PID control
 - Cascade control
 - On/ Off control
- Disconnection detection
- Various input functions: Bias, Filter, Square root
- Auto-tuning

XGF-TC4RT

- Input RTD : Pt100, JPt100, Pt1000
- Control Type : PID, On / Off Control



Specifications

Item	XGF-TC4UD		XGF-TC4RT	
No. of loop	4 loops		4 loops	
Input	Thermo couple	K	-200 ~ 1300 °C	-
			0 ~ 500 °C	
		J	-200 ~ 1200 °C	
			0 ~ 500 °C	
		E	-200 ~ 1000 °C	
		T	-200 ~ 400 °C	
		B	400 ~ 1800 °C	
		R	0 ~ 1700 °C	
		S	0 ~ 1700 °C	
		N	-200 ~ 1300 °C	
		C(W5Re/W26Re)	0 ~ 2300 °C	
	PL II	0 ~ 1300 °C		
	L	-200 ~ 900 °C		
	U	-200 ~ 600 °C		
	RTD	Pt100	-200 ~ 850 °C	-200 ~ 850 °C
		JPt100	-200 ~ 600 °C	-200 ~ 600 °C
		Pt1000	-200 ~ 800 °C	-200 ~ 800 °C
Voltage	DC mV	0 ~ 10mV	-	
		0 ~ 100mV		
	DC V	0 ~ 1V		
		1 ~ 5V		
		0 ~ 5V		
		0 ~ 10V		
-5V ~ 5V				
10V ~ 10V				
Current	DC mA	4 ~ 20mA	-	
		0 ~ 20mA		
Input channel	4 channels(Input type selection per channel)		-	

Specifications

Item	XGF-TC4UD		XGF-TC4RT		
Resolution	Resolution Refer to the user's manual (Resolution for each input type)				
Cold junction compensation	Compensation	Automatic compensation by RJC sensor	-		
	Precision	±0.2°C	-		
Digital output	Temperature display	0.1°C/1°C (Selection by software)	0.1°C		
	Linear display	0-1000	-		
	Scale display	Only for voltage/current input Range : -3,000-3,000 Setting range: 0-3000	-		
Conversion speed	200ms / module		400ms / 4loops		
Control type	PID, On/Off control				
Parameter	Set value (SV)	Selection per input type			
	Gain	0 : ON/OFF control, Real type Range : 0.000-10000.000			
	Integrated time	0 : No Differential control, Real type Range : 0.000-10000.000			
	Differential time	0 : No Integrated control, Real type Range : 0.000-10000.000			
Output	No. of output channel		8 channels (PWM or analog output)		
	PWM	Rated load voltage	DC 24V		
		Max. current point	0.1A points		
		On voltage drop	DC 0.3V or less		
		Off leakage current	0.1mA or less		
		Response time	ON⇒OFF	1ms or less	
			OFF⇒ON	1ms or less	
	Periodic	0.5-120.0sec (resolution: 0.5sec)			
	Time resolution	High value between 10ms or 0.5% of full scale			
	Analog output	Range	4-20mA		
Resistance		600Ω or less			
Resolution		±1.0%, 25°C			
Precision		8μA			
Insulation	Item	Insulation	Insulation withstand voltage		
	Channel - Channel	Trans	500V AC, 50/60Hz 1min, Leakage 10mA or less		
	Input terminal - PLC	Photocoupler	500V DC, 10MΩ or more		
	Current output - Current output External power- Output	Non insulation			
Warm-up	20min or more		-		
Terminal	18 points terminal				
Power	5V, DC 24V (external)				
Current consumption	DC 5V : 900mA (Internal) DC 24V : 300mA (external)		DC 5V: 310mA DC 24V: 28mA		

Example : Constant temperature

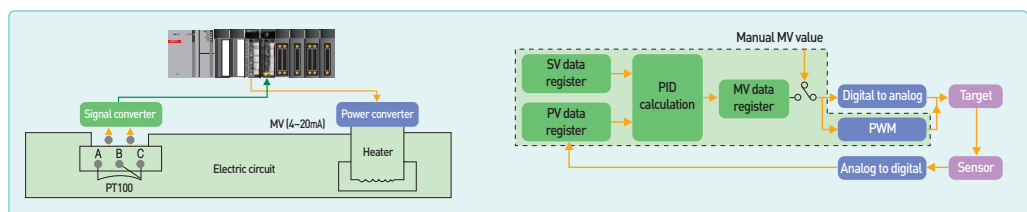

XG-TCON

- The configuration tool for the temperature control module
- Easy parameter settings, data monitoring and trend-monitor support
- Auto-tuning operation command to speed up the system is set up and test operation



Data Monitor

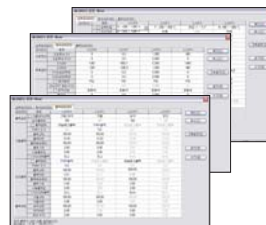

Parameter setting(input parameter)

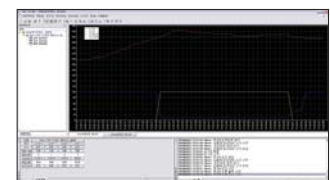

Trend monitor

SPECIAL



Features

- SOE: Sequence Of Events Recorder
- I/O information collection to analyze the control system in Generation and Transformer
- Event collection in every 1ms
- Max. 300ea data available
- Data retain by built-in memory
- Max. installable module: 16ea
- Event monitoring of history through SOE Viewer

Specifications

Item	XGF-SOEA
No. of input point	32 points
Insulation method	Photo-Coupler Insulation
Memory size	1Mbit
The first event setting time	CPU RTC : 1 ms (±2ms : delay between modules) RS-422 IRIG-B : 1 ms (±0.5ms : delay between modules)
Rated input voltage	DC24V
Rated input current	Approx. 4mA / points
Voltage range	DC20.4 ~ 28.8V(5% and lower ripple rate)
On voltage/On current	DC19V and higher / 3 mA and higher
Off voltage/ Off current	DC11V and lower/ 1.7 mA and lower
Input resistance	Approx. 5.6 kΩ
Response time (ms)	Off → On : 100us+Input filter time(User setting: 0~100ms) On → Off : 150us+Input filter time(User setting: 0~100ms)
Clock Synchronization	CPU RTC or RS-422 by IRIG-B format
Withstand voltage	AC560V rms/3 Cycle (altitude 2000m)
Insulation resistance	10MΩ and higher (DC500V)
COMM method	32point / COM
Current consumption	0.4 A (MAX)
Operation display	LED On with Input On
External connection method	40point connector
Size(mm)	27x98x90
Weight	0.2 kg

SOE Viewer

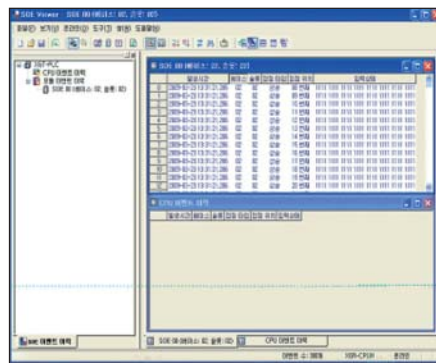

Monitoring window

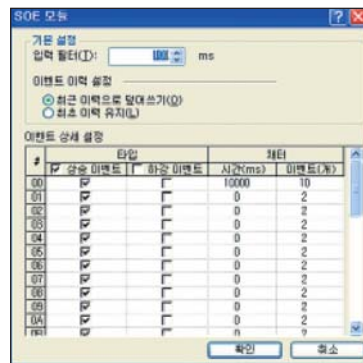

Parameter setup

Features

- Capable to easily save PLC device data without PC
- Capable to save PLC control data without missing any change
- Data can be saved whenever scanning is done or they can be saved at an interval of several ms(milliseconds).
- Capable to save a large volume of data file
- Long-term data saving is available since CF card and USB memory with a large volume of up to 16GB can be used.



Specifications

Item		XGF-DL16A					
CF Card	Voltage of power supply	3.3V ± 5%					
	Card Type	CF200I(Transcend's Industrial CF card)					
	Compatibility Capacity	1, 2, 4, 8, 16Gbyte					
	Number of mountable cards	1					
	Caution	Use only industrial CF cards manufactured by Transcend					
USB Memory	Voltage of power supply	5.0V ± 5%					
	Memory Type	USB 2.0 (Host function)					
	Compatibility Capacity	1, 2, 4, 8, 16Gbyte (Please use USB capacity above CF card capacity)					
	Saving Method	Auto Saving through PnP function (Activation of PnP auto duplication: when USB is mounted, when power is supplied again)					
	Number of mountable memories	1(Unavailable to support USB extension cables)					
Data Type	BOOL	0 or 1					
	BYTE	00 ~ FF					
	WORD	0000 ~ FFFF					
	DWORD	00000000 ~ FFFFFFFF					
	LWORD	00000000 00000000 ~ FFFFFFFF FFFFFFFF					
	SINT	-128 ~ 127					
	INT	-32,768 ~ 32,767					
	DINT	-2,147,483,648 ~ 2,147,483,647					
	LINT	-576,460,752,303,423,488 ~ 576,460,752,303,423,487					
	USINT	0 ~ 255					
	UINT	0 ~ 65,535					
	UDINT	0 ~ 4,294,967,295					
	ULINT	0 ~ 1,152,921,504,606,846,975					
	REAL	-3.402823466e+038 ~ -1.175494351e-038 or 0 or 1.175494351e-038 ~ 3.402823466e+038					
	LREAL	-1.7976931348623157e+308 ~ -2.2250738585072014e-308 or 0 or 2.2250738585072014e-308 ~ 1.7976931348623157e+308					
	STRING	Fixed letters (Maximum 8 letters)					
Data Saving	Number of Settings	Maximum 8					
	Number of Data	Maximum 32					
	Saving Kind	Saved by the ladder program					
	File Type	CSV file(Extension: csv)					
	Number of Saving Files	Total 800 (when using 16Gbyte CF memory)					
SavingSpeed	Processing Score(word)	4	16	64	256	1024	
	Processing Speed(ms)	1	4	10	30	120	
Time to Initialize CF card	Capacity(Gbyte)	1	2	4	8	16	
	Time(s)	10	20	40	60	120	
Collection Interval	1 ~ 9999999 ms (In consecutive saving)						
In/output Occupation Score	32 points 1 slot (Input 22 points, output 10 points)						
Clock	Synchronized at PLC CPU time whenever it is scanned						
DC5V Internal Consumption Current	0.53A						
External Size	98(H)[mm] x 27(W)[mm] x 90(D)[mm]						
Weight	0.13kg						

System Configuration

Data collection is available with simple settings

CSV File

	A	B	C	D
1	Time	Index	DWORD	WORD
2	2011/07/04/09:22:35.038	1807154	05701D3C	1D3C
3	2011/07/04/09:22:35.058	1807155	05701D3D	1D3D
4	2011/07/04/09:22:35.079	1807156	05701D3E	1D3E
5	2011/07/04/09:22:35.098	1807157	05701D3F	1D3F

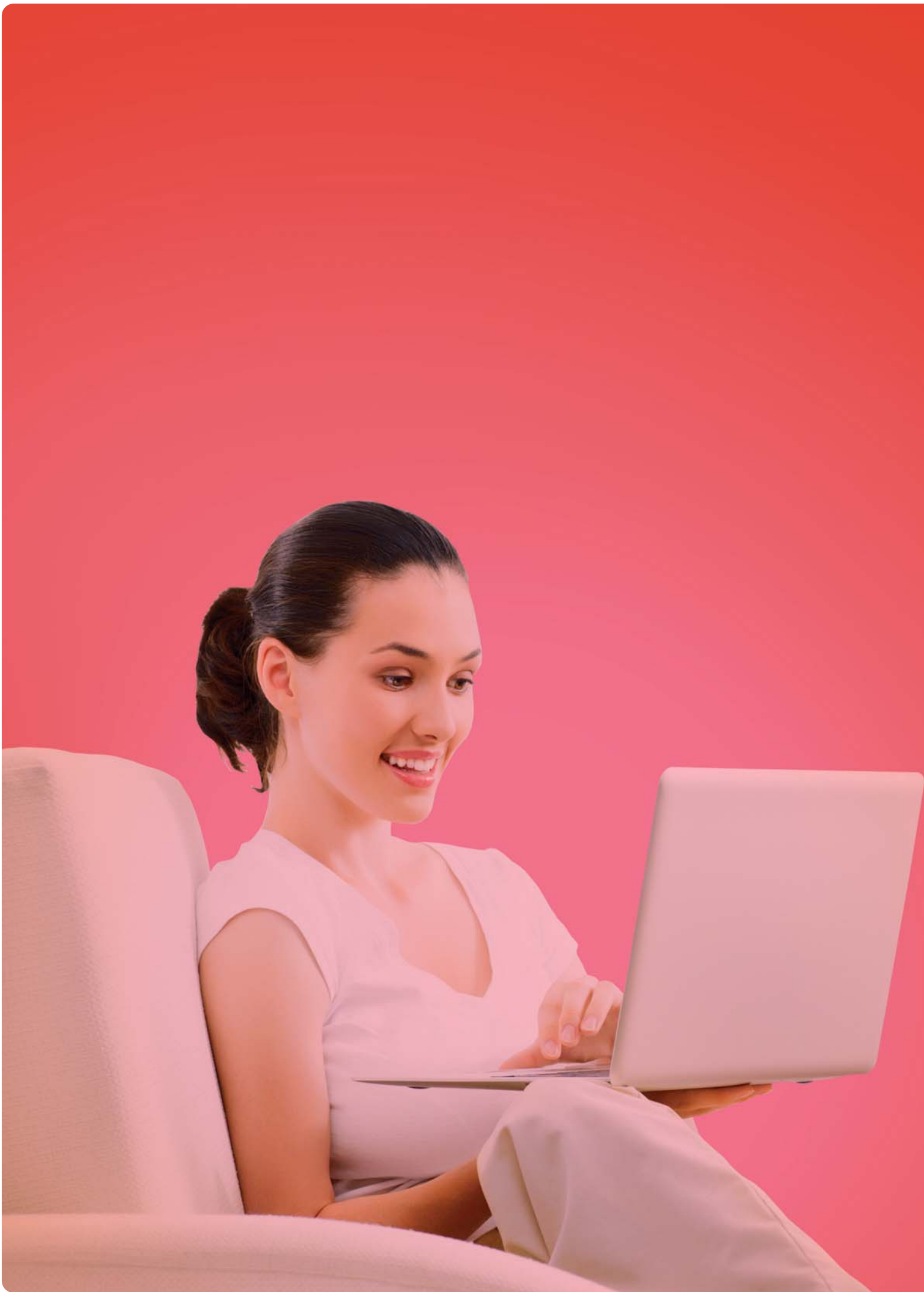



Software

Software innovation for integrated solution.

XG5000 is the optimum software which can cover various programming needs, debugging, and easy maintenance. Especially, XG5000 achieves customer satisfaction with useful maintenance tool by internet.

Contents	124 XG5000 programming
	134 XG5000 Communication Parameters
	136 XGT Panel iXP2 Series
	137 XGT Panel eXP2 Series
	139 APM[Positioning module] Software Package
	140 Product list
	142 Dimensions

Features



- Program editing & Engineering software
- Windows-based easy operation
- Multi-PLC, Multi-program, Multi-task in one project
- Various monitoring and diagnosis functions
- Windows 2000, XP, VISTA, Win7, Win8(32/64bits)
(Limited use in Windows 98, ME)

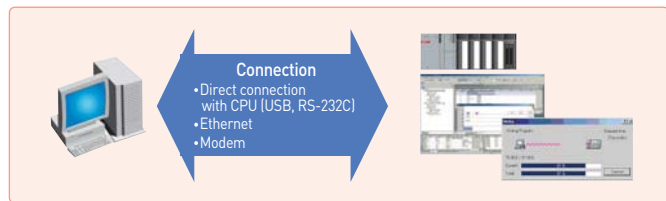
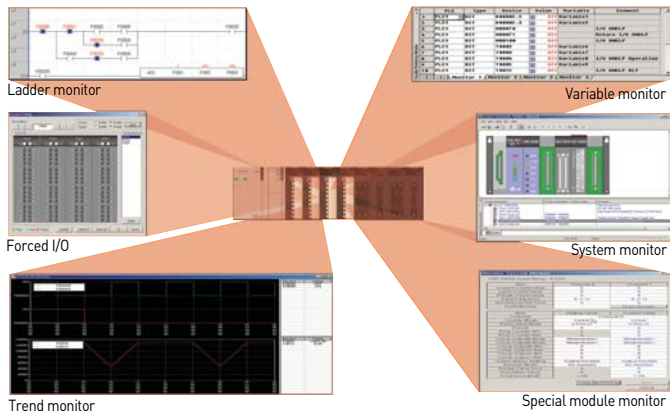

Programming tools

MPMP (Multi-PLC Multi-programming)
Different PLC systems can be edited, monitored, and managed simultaneously in one project.

Drag & Drop

It is available in project, variable/comment, ladder diagram editing and monitoring.

User-defined shortcut keys

User-defined shortcut keys increase editing convenience.

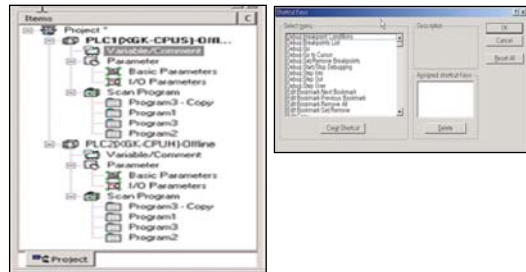

Monitoring

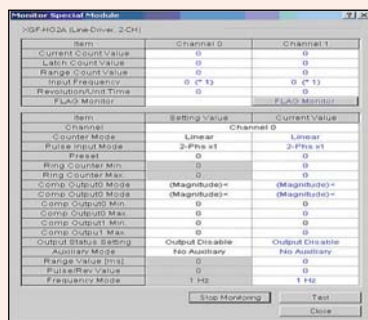

Special module monitoring

Monitoring and test-run of various special modules are available.

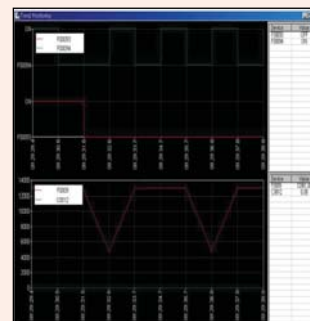

Trend monitoring

The changing value of specific device can be monitored and saved as a file.



System monitoring

Value	Variable	Comment

Monitor 1 | Monitor 2 | Monitor 3 | Monitor 4

Variable monitoring

System requirement

Item	System requirement
O/S	Windows 2000, XP, VISTA, Win7, Win8(32/64bits) (Limited use in Windows 98, ME)
CPU	IBM compatible PC with Min. 200MHz Pentium processor
Memory	Min. 128M
HDD	100 MB (Free memory space)
Serial port	Communication port for program transmission (RS-232C, USB)
Printer	Compatible with Windows 98 or later
Mouse	Compatible with Windows 98 or later

Variable and programming editing

- Data input like EXCEL
- Cell-unit edit
- Auto Fill function
- Compatible with Microsoft Excel
- Redo and Undo (Unlimited)
- Segment screen edit

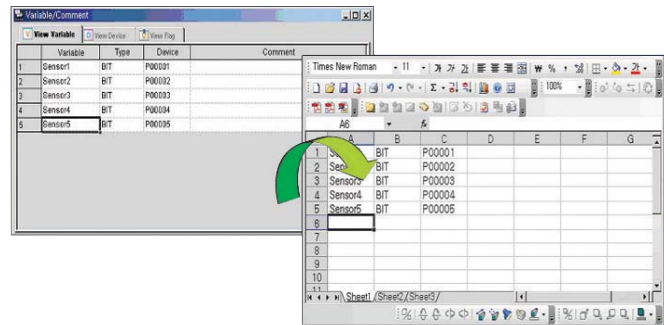

Improved diagnosis and maintenance



Module exchange wizard
It supports safe module exchange during 'RUN' mode.

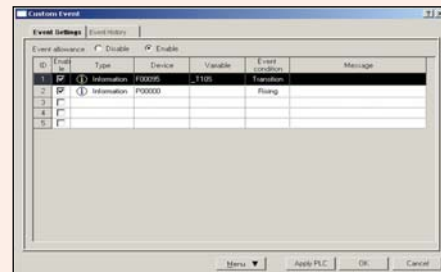

User-defined event
By registering user-defined event, users can read the record of specified event and use it for PLC operation and debugging



Forced I/O
The status of external output device can be checked without program. And when input device breaks down, forced input function specifies ON/OFF and can operate the system without interruption of equipment.

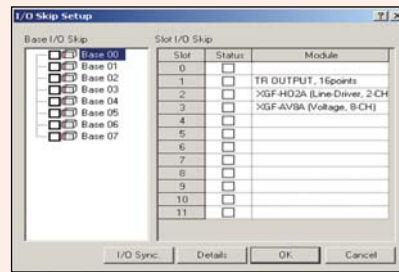

I/O skip, Error Mask
I/O inspection and renewal can be set for specific module and continuous operation is available when an error is occurred.

Program editing

- Start XG5000
- Select [New Project]
- Write project name and select CPU type

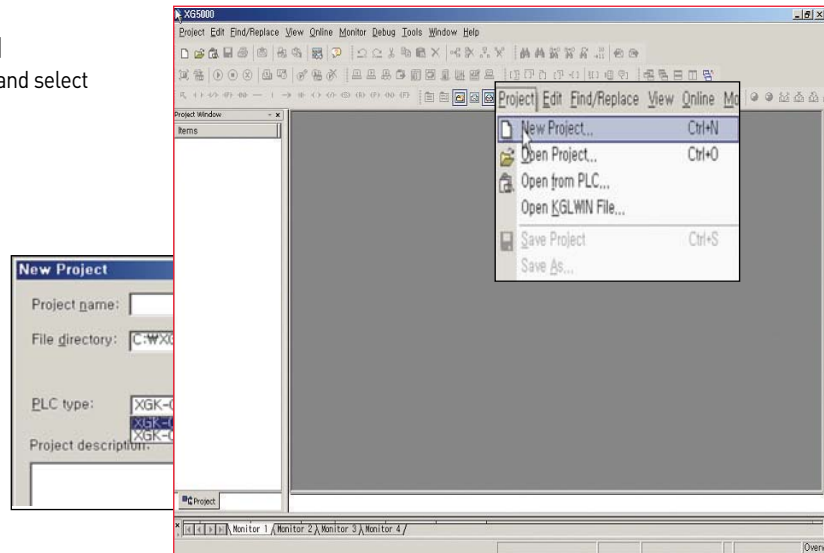

Configure ladder lines as below with ladder input tool bar

- Select input point and command with ladder tool bar.

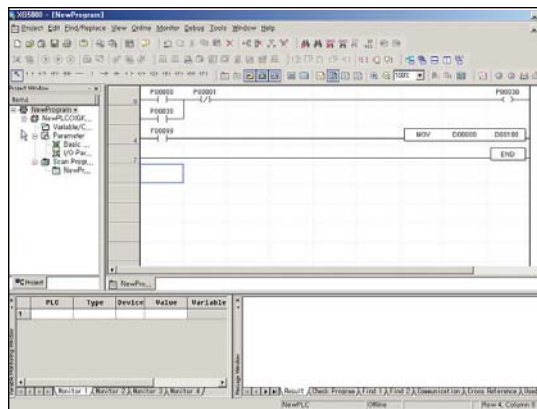

Icon	Description	Short key
	Arrow mode	ESC
	Normally open contact	F3
	Normally closed contact	F4
	Positive transition-sensing contact (On for 1 scan when Off → On)	Shift+F1
	Negative transition-sensing contact (On for 1 scan when On → Off)	Shift+F2
	Horizontal line	F5
	Vertical line	F6
	Fill horizontal line	Shift+F8
	Coil	F9
	NOT instruction contact	Shift+F9
	Negated coil	F11
	SET coil	Shift+F3
	RESET coil	Shift+F4
	Positive transition-sensing coil (On for 1 scan when Off → On)	Shift+F5
	Negative transition-sensing coil (On for 1 scan when On → Off)	Shift+F6
	Function	F10

Note) Addition of 'EDGE' detection instructions

Develop user-friendly programming through adding D, D NOT instructions (Rising EDGE, dropping EDGE) to contact and output coil.

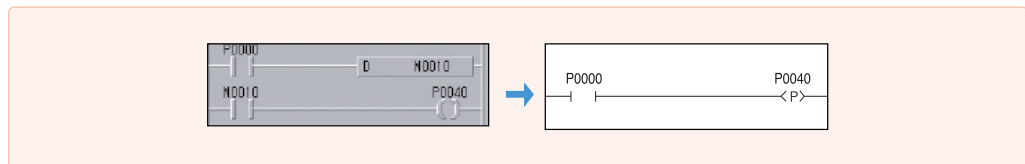

Program download

Connection setting

- Check a setting for connection between XGT and XG5000
- XGT supports USB and RS-232C

Set up communication port and download speed

* using 'USB TO RS-232C' converter, 115,200bps connection may be unavailable depending on characteristics of converter. In this case, change the communication speed to 38,400bps.

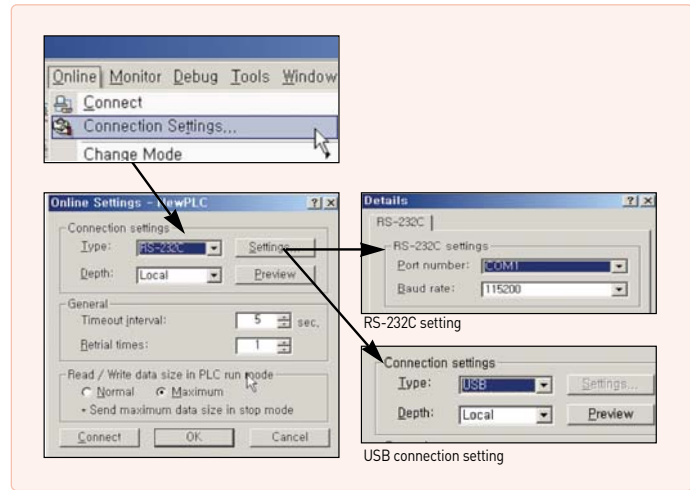

Connection

Connect to PLC and download the program as below.

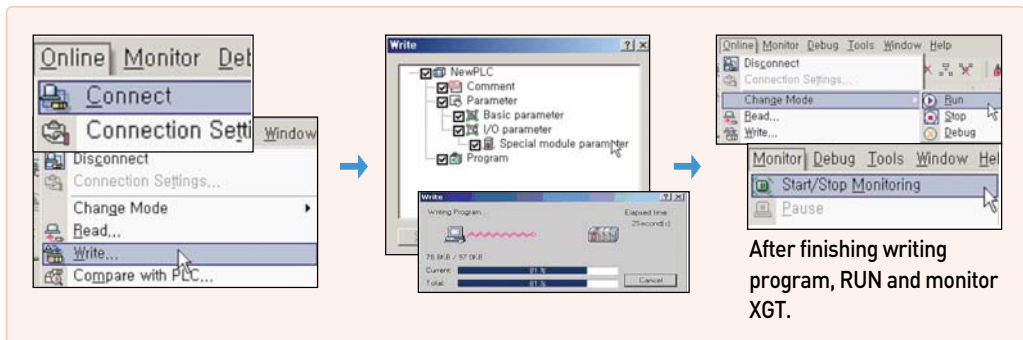

Short icon

* XGT doesn't support collective-writing monitoring for system safety.

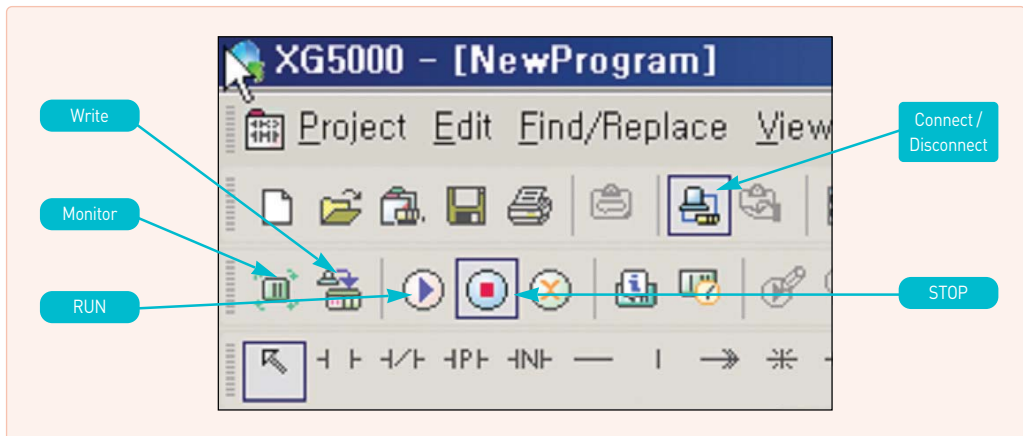

Online Editing

Select [Start Online Editing] in Online menu.

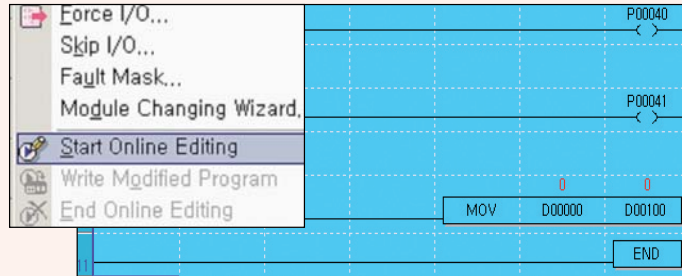

When starting Online Editing, the screen color becomes blue.

Modify the program.

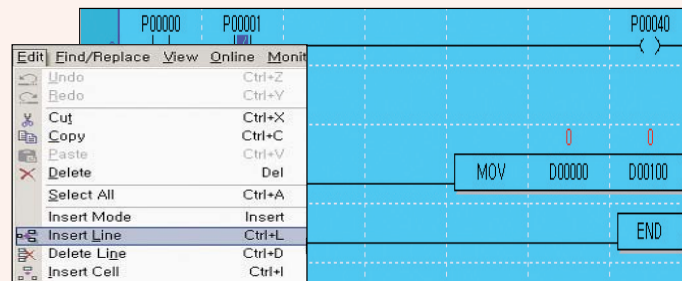

Edit menu

After finishing modifying the program, select [Write Modified Program] and [End Online Editing].

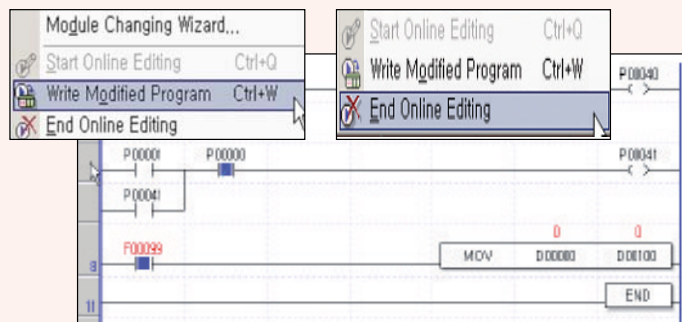

After finishing 'Online Editing'

Open a project written in KGL-WIN

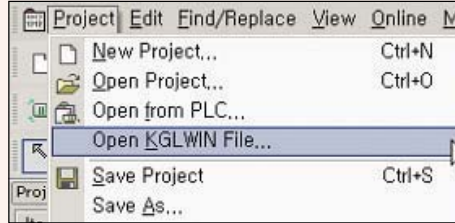

Select [Open KGLWIN file] in project.

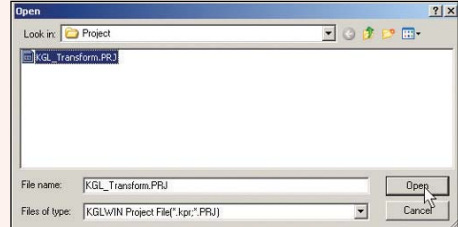

Select the file.

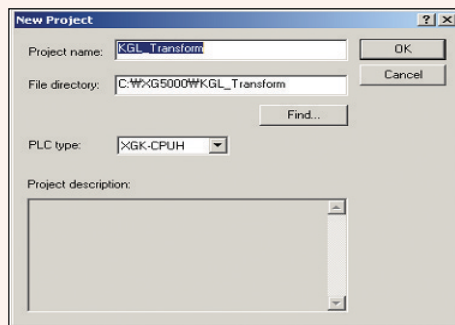

Select the type of XGT CPU.

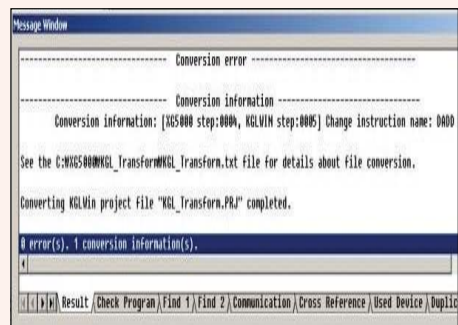

Check converted information in the message window.

Note) Dedicated instructions and special parameters for MASTER-K cannot be converted.
 Mostly General instructions and descriptions are converted.
 Information impossible to be converted is displayed as ERR.

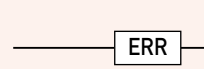

• Content of main special flag (F) change

MASTER-K	XGT	Specifications
F10	F99	ON regularly
F11	F9A	OFF regularly
F12	F9B	ON during first one scan
F13	F9C	OFF during first one scan

For more detailed information, refer to user's manual.

Data type

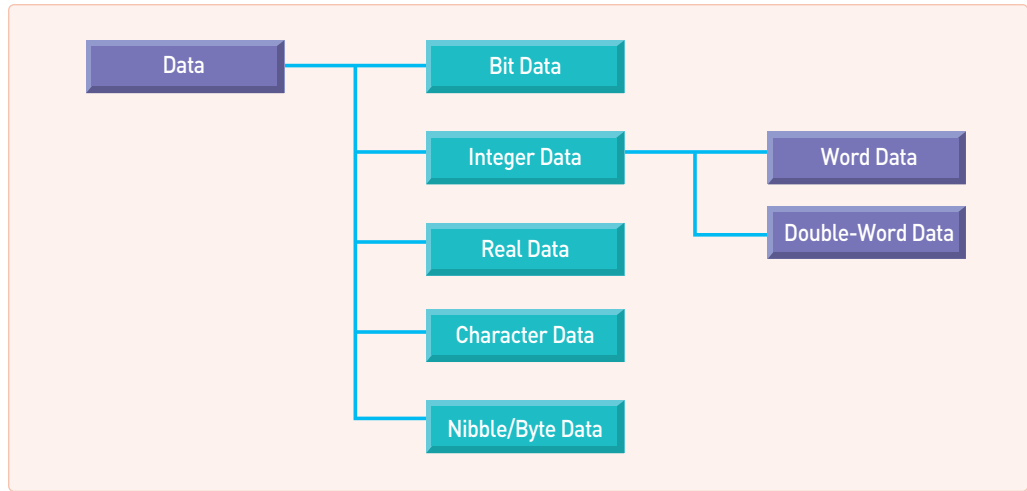

- Nibble: 4-bit unit data
- Byte: 8-bit unit data
- Real Data: 32-bit/64-bit floating point data

Real Number

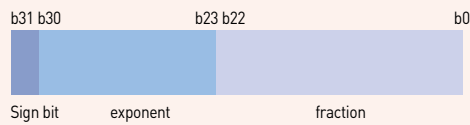

Long Real Number

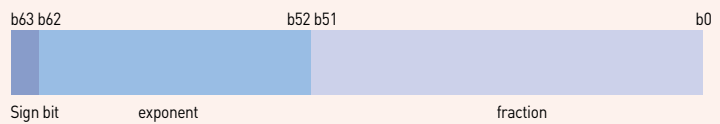

- Character Data: Saving numbers, alphabets, symbols as a type of ASCII code

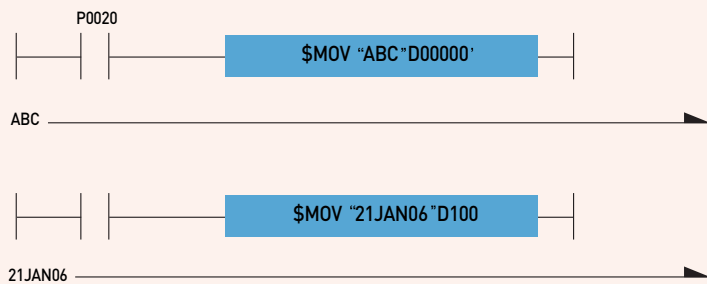

D100	0x31	0x32
D101	0x41	0x4A
D102	0x30	0x4E
D103	0x00	0x36
D104	0x00	0x36

Device type

Device	Size	Bit Contact	Word Data	Name
P	32768 points	P00000 ~ P2047F	P0000 ~ P2047	I/O Relay
M	32768 points	M00000 ~ M2047F	M0000 ~ M2047	Assistant Relay
L	180224 points	L00000 ~ L11263F	L0000 ~ L11263	Link Relay
N *1)	21K words	N/A	N00000 ~ N21503	Comm. data register
K	32768 points	K00000 ~ K2047F	K0000 ~ K2047	Keep Relay
F	32768 points	F00000 ~ F2047F	F0000 ~ F2047	Special Relay
T *2)	2048 points	T0000 ~ T2047	T0000 ~ T2047	Timer
C *3)	2048 points	C0000 ~ C2047	C0000 ~ C2047	Counter
U	3072 words	U00.00.0 ~ U7F.31.F	U00.00 ~ U7F.31	Special Module Counter
Z	128 words	N/A	Z0 ~ Z127	Index Register
S	128 groups	S00.00 ~ S127.99	N/A	Step Control Relay
D	32K words	D00000.0 ~ D32767.F	D00000 ~ D32767	Data Register
R (Internal RAM) *4)	32K words	R00000.0 ~ R32767.F	R00000 ~ R32767	File Register
ZR (Internal RAM) *5)	32K words	N/A	ZR00000 ~ ZR65535	File Register
R (Expanded)	1M words	N/A	Available as much as extension size	File Register
ZR (Expanded)	1M words	N/A	Available as much as extension size	File Register

- Note)** 1. When communication module is not used, it can be used as internal data area.
 2. Word data in timer shows a current value of relevant bit contact.
 3. Word data in counter shows a current value of relevant bit contact
 4. Even when using more than 32K words internal RAM, bit contact available to display is R00000.0~R32767.F Also word data enable to be displayed in the range of R00000.0~R32767.F
 5. When internal RAM is more than 32K words, bit contact can be in the range of ZR00000.0~ZR32767.F and word data can be displayed as much as the size of internal RAM

Special module register U

Register for reading data from special module mounted in slot

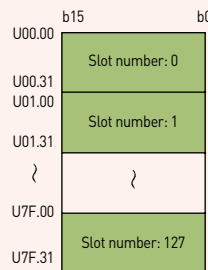

- Assigning 32 words per slot in U area
- Bit type display available
Ex) U93.12.x (x: Bit location, Hexadecimal display)
- Available to read/write internal memory value of special module without using PUT (P), GET (P), PUTS (P), GETS (P)
- Basic display in U area
Ex) Uxy.z
x: Base number (0~7)
y: Slot number (0~F)
z: Word number of special module internal memory

File register R, ZR

Register that a recorded value is not deleted when power failure is occurred. File register is used for data backup or data storage.

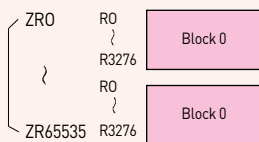

- R: Block unit access
- ZR: Entire file register access
- Internal RAM (Temporary preservation): 32K words
- FLASH (Permanent preservation): 1M words

Index register

Index register sets up devices using index function.
 The sum of index register value and directly specified device number is real device number.

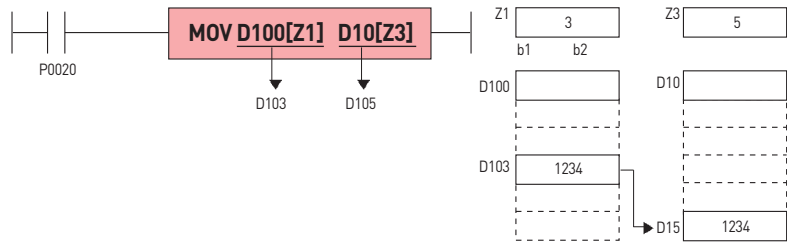

Available Device

- Bit Device: P, M, L, K, F, T, C
 - Word Device: U, D, R, ZR, N, present value of T and present value of C
- Ex) MOV T1[Z1] D10 : If Z1 is 5, present value of T(1+5)=T6 is transmitted to D10.
 Ex) LOAD D10[Z1].5 : If Z1 is 5, LOAD(10+5).5 => LOAD D15.5 is set.

Bit specifying method of word device

By assigning bit number to word device, bit data is available to use.

Word device number · Bit number

In this case, word device number should be addressed as decimal and bit number should be addressed as hexadecimal.
 Relevant Device: U, D, R

Instructions

Classification	Designations	Symbol	Description	No. of step
16 Bits transfer	MOV	MOV S D	(S) → (D)	2
	MOVP	MOVP S D		3
32 Bits	DMOV	DMOV S D	(S+1, S) → (D+1, D)	2
	DMOV P	DMOV P S D		

① **Classification:** Classifies instructions into applications.

② **Designations:** Displays instruction names to be used in program.

- Display rules: Instructions shall be basically displayed in word unit. According to data size, operation characteristics, real number data process, text process, the rules are as follows;
- Based on Data Size & Type
 - D: Double Word related instruction.
 - R: Real Number related instruction.
 - L: Long Real Number related instruction.
 - However, LMOV is 64 Bits transfer instruction.
 - \$: String related instruction.
 - G: Group calculation.
 - 4: Nibble related instruction, used only at the back of instruction.
 - 8: Byte related instruction, used only at the back of instruction.
 - 3: Instruction that process 3 operands, used only at the back of instruction.
- Based on Operation Characteristics
 - P: Instruction that is executed for 1 scan when input signal is changed OFF => ON

③ **Symbol:** Displays symbols used in program, showing the number of used operands and the type of Source or Destination. Operand display rules are as follows;

- S: Source, with data value not changed after calculated.
- D: Destination, with data value changeable after calculated.
- N, n: The number to process.
- St, En: Start and End, used only in BSFT & WSFT.
- Sb: Source in case Bit position is specified, mostly used in Nibble/Byte instruction.
- Db: Destination in case Bit position is specified.
- Z: Control word, which means previously specified format as based on each instruction.

④ **Description:** Describes general functions of instruction.

⑤ **No. of step:** The number of basic steps of instruction, which means the number of steps in case indirect specification, index formula and direct variable input were not used.

Features

- Default settings of the network and easy of user program
- Network system and provides extensive monitoring and control of the communication module
- Efficient implementation of a fast interface with the CPU to the network management
- Easy access with XGT and Modbus
- Rich built-in diagnostic function (Condition of CPU, Link, Auto SCAN, Frame monitor)

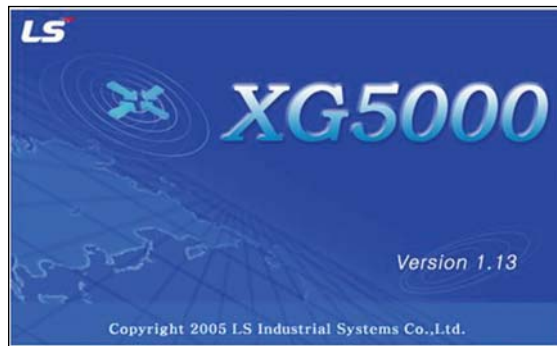

Item	Industrial Ethernet network				Fieldbus network					
	RAPIenet	EtherNet/IP	Modbus TCP/IP	XGT dedication	Cnet	Fnet	Rnet	DeviceNet	Profibus-DP	
Network service	Smart extension	○	○	-	-	-	-	-	-	-
	High speed link	○	-	-	○	-	○	○	○	○
	P2P	○	○	○	○	○	-	-	-	○
	XGT server	-	-	-	○	○	-	-	-	-
	Modbus server	-	-	○	-	○	-	-	-	-
Smart extension	Max. station	63	63	-	-	-	-	-	-	-
	Network cycle time	2-1000ms	2-2147,483,647ms	-	-	-	-	-	-	-
	No. of block	64	64	-	-	-	-	-	-	-
	Data per block	768 bytes	1400 bytes	-	-	-	-	-	-	-
High speed link	Max. station	64	-	-	64	-	64	64	63	123
	No. of block	128	-	-	128	-	64	64	63	123
	Send block	64	-	-	32	-	32	32	63	123
	Receive block	128 - Send block	-	-	128 - Send block	-	64 - Send block	32	63	123
	Data per block	200 words	-	-	200 words	-	60 words	60 words	256 bytes	244 bytes
P2P	No. of block	64	64	64	64	64	-	-	-	64
	Data per block	1400 bytes	1400 bytes	125 bytes	1400 bytes	256 bytes	-	-	-	244 bytes
Transmission speed Media	100/1,000Mbps	100/1,000Mbps	100/1,000Mbps	100/1,000Mbps	900-115,200Mbps	1Mbps	1Mbps	125/250/500kbps	9.6k-12,000kbps	
Topology	Ring, Line, Srat	Line, Srat	Line, Srat	Line, Srat	Bus	Bus	Bus, Srat	Bus, Srat	Bus, Srat	
Configuration Tool	XG5000							XG5000 / N Configurator		

Various network diagnosis and monitoring

- Auto Scan: Searching and displaying each node connected to network
- Ping Test : Indicates the port connection status of other stations connected to the network.
- View Communication Module Log : Communication module history view function of XG5000 program can check whether error occurred and measures
- Remote O/S download : Update OS of the remote module connected to the network.
- Loopback test : This function is to check for port anomalies and performs a loopback test for each port.
- System synchronization : Synchronize current PLC status to system diagnosis
- Frame Monitor: Collecting and displaying sending/receiving frame in real time

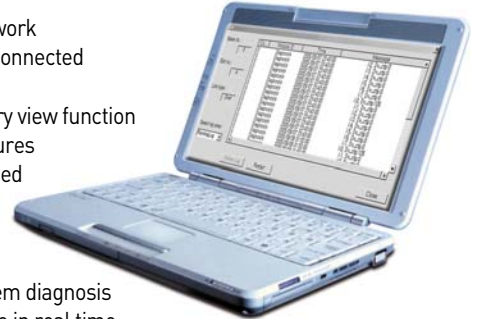

Item	Industrial Ethernet network				Fieldbus network				
	RAPIDnet	EtherNet/IP	Modbus TCP/IP	XGT dedication	Cnet	Fnet	Rnet	DeviceNet	Profibus-DP
Communication module status	○	○	○	○	○	○	○	○	○
Service status	○	○	○	○	○	○	○	○	○
Media information	○	○	○	○	○	-	-	-	-
Auto Scan	○	○	○	○	-	○	○	○	○
Ping Test	-	○	○	○	-	-	-	-	-
View Communication Module Log	○	○	○	○	○	○	○	-	○
Remote O/S download	○	-	-	-	-	-	-	-	-
Loopback test	○	○	○	○	○	-	-	-	-
System synchronization	○	○	○	○	○	○	○	○	○
Frame monitor	-	-	-	-	○	-	-	-	-

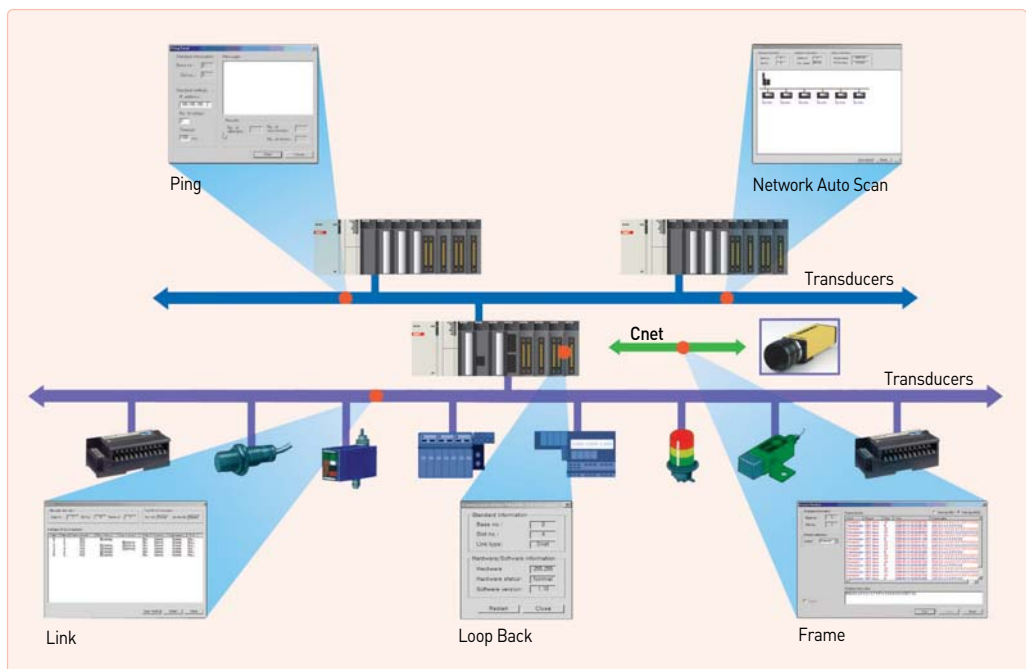

Main Specification

- Aluminum body frame, responsive touch screen.
- Easy-to-use Multi-touch, gesture, dual screen, portrait mode.
- Multi connected with 1Gbits 2ch. Ethernet between PC to PLC.
- Various interfaces : USB host /device, SD card, HDMI.
- High resolution : 1024 X 768
- IP66, UL type 4x, NEMA 4x standards
- Explosion proof. IECEx, ATEX, KCs



Item	iXP2-0800A/D	iXP2-1000A/D	iXP2-1200A/D	iXP2-1500A/D
Display type	TFT color LCD			
Screen size	8.4"	10.4"	12.1"	15"
Display resolution	800 × 600	1,024 × 768		
Color indication	24-bit color (16.7M colors)			
Backlight	LED method, automatic On / Off support			
Backlight lifetime	50,000 hour			
Touch panel	Capacitive touch			
Audio output	Magnetic buzzer [85dB]			
Processor	1GHz, Dual core			
Memory	Flash	1GB		
	Operating RAM	1GB		
	Backup RAM	1 Mbyte		
Backup data	Date / Time data, Logging / Alarm / Recipe data, Non-volatile devices			
Battery	CR2032(3.0V/210mAh, About 3years/25 °C)			
Video output	1 × HDMI			
Ethernet	1 × 10Base-T / 100Base-TX, 1 × 10Base-T / 100Base-TX / 1000Base-T			
USB host	3 × USB 2.0 (Front × 1, Rear × 2)			
USB device	1 × USB 2.0 (Send / Receive front, PC and project data etc.)			
RS-232C	1 × RS-232C (DSUB 9 / Male type)			
RS-422/485	1 × RS-422/485 (Terminal block)			
Multi-language	Can display 12 languages simultaneously			
Animation	GIF format support			
Recipe	Support			
Data logging	Support			
Script launcher	Support			
Standard certification	CE, KC, UL, IECEx, ATEX, KCs			
Protection standard	IP66, Conform to the UL type 4x, NEMA 4x standard			
Explosion proof	Ex nA IIC T5 Gc, Ex tc IIIC T100°C Dc IP64			
Dimensions (mm)	240 × 180 × 60	271 × 212 × 60	313 × 239 × 60	395 × 294 × 66
Panel cut (mm)	228.5 × 158.5	259.0 × 201.0	301.5 × 227.5	383.5 × 282.5
Power	iXP2-xxxxA : AC100 / 240V, iXP2-xxxxD : DC24V			
Power consumption (W)	25	25	30	30
Weight (Kg)	1.87	2.35	3.0	4.6

XGT Panel eXP2 Series

Programmable Logic Controller 136 / 137

Fully compatible with eXP

- Panel cut, interface, design, and drawing file are 100% compatible.

Superior Performance

- ARM Cortex A8 800MHz, eMMC 4G, DDR3

Enhanced product reliability

- LCD Backlight lifespan extended
- Non Battery Type NVRAM

Variety of interfaces and functions

- Various communication drivers and Micro SD I/F available



Item	eXP2-04□*0D	eXP2-05□*0D	eXP2-05□*2D	eXP2-07□*0D	eXP2-07□*1D	eXP2-07□*2D	eXP2-10□*0D	eXP2-10□*1D	
Display Type	TFT Color LCD								
Screen Size	10.9cm (4.3")	14.2cm (5.6")		17.8cm (7")			25.9cm (10.1")		
Display Resolution	480 x 272	640 x 480		800 x 480			1024 x 600		
Color Indication	24Bit Color (16.7M)	18Bit Color (262,144)		24Bit Color (16.7M)			24Bit Color (16.7M)		
Indication Degree	Left/Right: 60 deg. Upper: 40 deg. Lower: 50 deg.	Left/Right: 60 deg. Upper: 40 deg. Lower: 60 deg.		Left/Right: 70 deg. Upper: 50 deg. Lower: 70 deg.			Left/Right: 70 deg. Upper: 50 deg. Lower: 70 deg.		
Backlight	LED Type (Supports Backlight Auto-off Function)								
Backlight Duration	50,000 Hours	20,000 Hours		50,000 Hours			30,000 Hours		
Touch Panel	4-Wire Resistive, Analog								
Audio Output	Magnetic Buzzer (85dB)								
Process	800MHz	800MHz		800MHz			800MHz		
Memory	Drawing Memory	64MB	64MB		64MB			64MB	
	Operating RAM	512MB	512MB		512MB			512MB	
	Operating RAM	128KB	128KB		128KB			128KB	
Backup Data	Date/Hour Data, Logging/Alarm/Recipe Data and Nonvolatile Device								
Battery Life	Approx. 3 years (Operating Ambient Temperature of 50°C)								
Ethernet	1 Channel, IEEE802.1a, 10Base-T/100Base-TX	-		1 Channel, IEEE802.1a, 10Base-T/100Base-TX		-		1 Channel, IEEE802.1a, 10Base-T/100Base-TX	
USB Host	1 Channel, USB 2.0 Host (Mouse, keyboard, printer, USB flash drive, etc.)								
USB Device	-	1 Channel, USB 2.0 Device (for Download and Upload Project)					1 Channel, USB 2.0 Device (for Download and Upload Project File)		
Micro SD Card	-	-		-	1 Channel SDHC Class10	-		1 Channel SDHC Class10	
RS-485,RS-232C	1 Channel, RS-232C (DSUB 9/Male Type)			2 Channels, RS-485, RS-232C (DSUB 9/Male Type)					
RS-422/485	1 Channel, RS-422/485 (DSUB 9/Male Type)			1 Channel, RS-422/485 Mode (Terminal Type)					
Multi-language	Up to 12 Language Simultaneously								
Animation	GIF Format is Available								
Recipe	Available								
Data Logging	Available								
Script Executor	Available								
Certifications	CE, UL(cUL), UL Type 4X, KC		CE, UL(cUL), KC		CE, UL(cUL), UL Type 4X, KC		CE, UL(cUL), KC		
Protection Standard	IP65 ^{Note 1)}		IP65 ^{Note 1)}		IP65 ^{Note 1)}			IP65 ^{Note 1)}	
Dimension (mm)	128 x 102 x 32.5	165 x 132.5 x 36.1		208 x 154 x 44.4			276 x 218 x 35.1		
Panel Cut (mm)	119 x 93	156 x 123.5		192 x 138			260 x 202		
Rated Voltage	DC24V		DC24V		DC24V			DC24V	
Power Consumption (W)	4	5.5	5.5	6			6		
Weight (kg)	0.27	0.43	0.43	0.59	0.59	0.58	1.0	1.0	

□*0 (WinCE 7.0 Core), 1 (WinCE 7.0 Pro)

Note 1): IP66 for UL Type 4X models.

SOFTWARE

Text type XP10

- Screen: 192×64 Graphic STN LCD
- System RAM: 1000 words
- Flash memory: Program/Parameter back up
- Communication: Half-duplex comm.
 - Baud rate: 1200~115200 bps
 - Master/slave setting available
 - RS-232C/RS-485 2 CH separate to use
- Power requirements - 24 V input or 5 V direct input by LS PLC
- Various function key - ESC, ALM, SET, ENT, F1~F4, Arrow keys
- Panel Editor - Easy programming and H/W setting

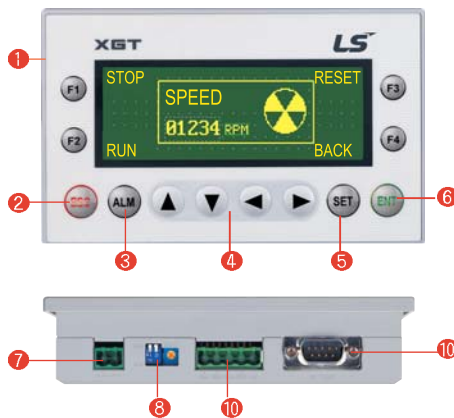

- 1 Key to control PLC device and screen
- 2 ESC key
- 3 Alarm history
- 4 Data input and Screen change
- 5 PLC data setting
- 6 Enter key
- 7 DC24V input terminal
- 8 RS-232C port to download a project
- 9 Brightness adjustment
- 10 RS-422 port

Item		Specifications	
		XP10BKA/DC	XP10BKB/DC
Input voltage	5VDC	DC 4.9 ~ 5.1 (RS-232C port)	
	24VDC	DC 21.6 ~ 26.4 (DC Input connector)	
	Consumption current	Less than 200mA	
Display		LED back-light (192 x 64 Dots)	
Communication interface		RS-232C, RS-422/485	
Flash memory		256K bytes	
Language		Default: English, Can be switched to Korean/Chinese/Russian	
RTC		None	Supports
Download specification		115,200bps	
Keys		12 Keys (F1~F4, ESC, ALM, ▲, ▼, ◀, ▶, SET, ENT)	

Features

- Windows-based easy operation
- Supporting all types of LS APM module
- Improved parameter editing (Copy, Paste, Initialization, etc.)
- Various monitoring (Operation type of each axis, etc.)
- Profile trace and operation monitoring
- Profile graph and simulation of circular interpolation
- Available to edit operation parameter in EXCEL

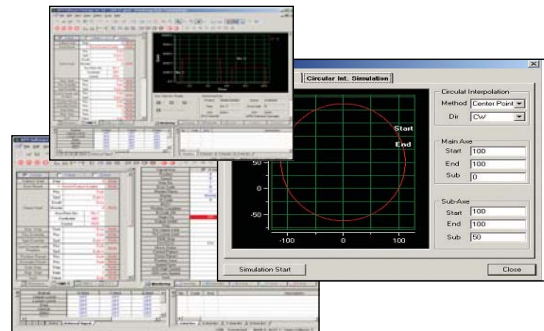

Step	Cond	Control	Pattern	Method	Address (pulse)	Sub Address (pulse)	M Code	A/D No.	Speed (pulse/s)	Dwell (ms)	Cr/Int/Dr
1	ABS	POS	END	SIN	10000	0	0	No1	1000	0	Dw
2	ABS	POS	END	SIN	0	0	0	No1	0	0	Dw
3	ABS	POS	END	SIN	0	0	0	No1	0	0	Dw
4	ABS	POS	END	SIN	0	0	0	No1	0	0	Dw
5	ABS	POS	KEEP	SIN	100000	0	0	No1	0	0	Dw
6	ABS	POS	END	SIN	0	0	0	No1	10000	0	Dw
7	ABS	POS	END	SIN	0	0	0	No1	10000	0	Dw
8	ABS	POS	END	SIN	0	0	0	No1	0	0	Dw
9	ABS	POS	END	SIN	0	0	0	No1	0	0	Dw
10	ABS	POS	CONT	SIN	100000	0	0	No1	0	0	Dw
11	ABS	POS	END	SIN	1000	0	0	No1	10000	0	Dw
12	ABS	POS	END	SIN	0	0	0	No1	5000	0	Dw

Operation Data

Define operation method, target location, operation speed of each axis.

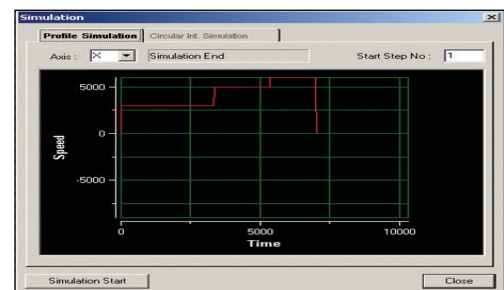

Profile simulation (Off-line)

Monitoring operation speed of each axis with graph type and saving result as image file.

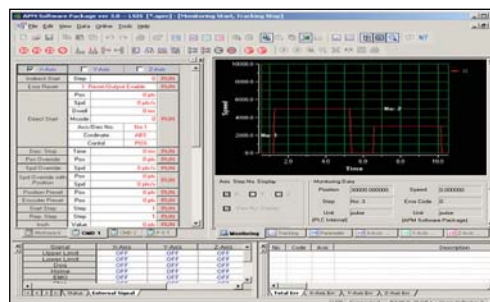

Profile Trace (On-line)

Monitoring operation speed of each axis with graph type and saving result as image file.

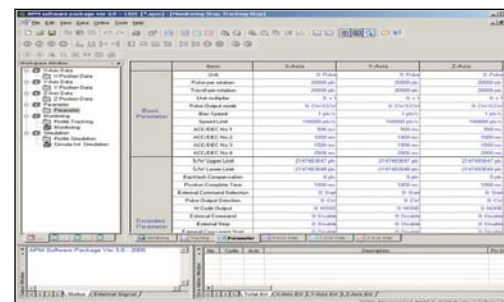

Operation parameter

Setting basic operation characteristics and limit value.

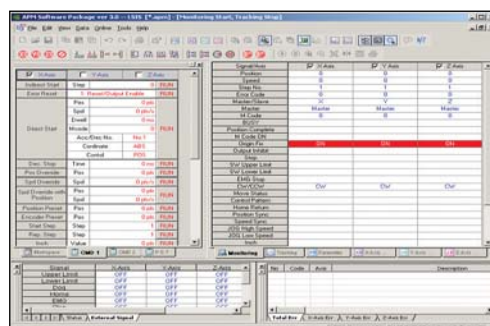

Monitoring (On-line)

Checking basic operation characteristics about each axis and monitoring operation condition.

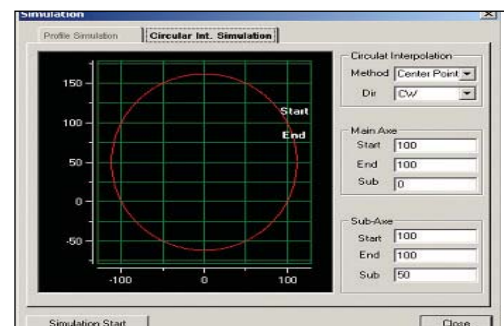

Circular interpolation simulation (Off-line)

CPU / PWR / Base / I/O

CPU	XGK-CPUH,* CPUU, CPUHN, CPUUN	6,144pt, Program memory : 64Ksteps
	XGK-CPUS,* CPUA, CPUSN	3,072pt, Program memory : 32Ksteps
	XGK-CPUE*	1,536pt, Program memory : 16Ksteps
	XGI-CPUUN, CPUUD, CPUU, CPUH*	9,144pt (IEC type), Program memory:1Mbyte
	XGI-CPUS*	3,072pt (IEC type), Program memory:128kbyte
	XGI-CPUE*	1,536pt (IEC type), Program memory:64kbyte
Power	XGP-ACF1*	Free Voltage/DC5V 3A, DC24V 0.6A
	XGP-ACF2*	Free Voltage/DC5V 6A
	XGP-AC23*	220V/DC5V 8.5A
	XGP-DC42*	DC24V/DC5V 6A
Main base	XGB-M04A*	4 Slot
	XGB-M06A*	6 Slot
	XGB-M08A*	8 Slot
	XGB-M10A*	10 Slot
	XGB-M12A*	12 Slot
Expansion base	XGB-E04A*	4 Slot
	XGB-E06A*	6 Slot
	XGB-E08A*	8 Slot
	XGB-E12A*	12 Slot
Input	XGI-A12A	AC110V, 16pt
	XGI-A21A	AC220V, 8pt
	XGI-A21C	AC 220V Input, 8pt(1COM)
	XGI-D21A	DC24V, 8pt
	XGI-D22A*	DC24V, 16pt, Sink/Source
	XGI-D22B	DC24V, 16pt, Source
	XGI-D24A*	DC24V, 32pt, Sink/Source
	XGI-D24B	DC24V, 32pt, Source
	XGI-D28A*	DC24V, 64pt, Sink/Source
	XGI-D28B	DC24V, 64pt, Source
Output	XGQ-RY1A	Relay, 8pt
	XGQ-RY2A*	Relay, 16pt
	XGQ-RY2B	Relay, 16pt, Surge killer
	XGQ-SS2A	Triac, 16pt
	XGQ-TR1C	Transist, 8pt(2A, 1COM)
	XGQ-TR2A*	Transist, 16pt, Sink
	XGQ-TR2B	Transist, 16pt, Source
	XGQ-TR4A*	Transist, 32pt, Sink
	XGQ-TR4B	Transist, 32pt, Source
	XGQ-TR8A*	Transist, 64pt, Sink
XGQ-TR8B	Transist, 64pt, Source	
Input/output	XGH-DT4A*	DC24V 16pt, Transist, 16pt, Sink

* : G3 Coating Products

Special module

Analog input	XGF-AV8A*	Voltage, 8ch
	XGF-AC8A*	Current, 8ch
	XGF-AD8A*	Voltage/Current, 8ch
	XGF-AD16A*	Insulation Voltage /Current, 16ch
	XGF-AD4S*	Voltage /Current, 4ch
Analog output	XGF-AW4S*	2-wire, Voltage/ Current input, 4Ch (Isolated)
	XGF-DV4A*	Voltage, 4ch
	XGF-DC4A*	Current, 4ch
	XGF-DV8A*	Voltage, 8ch
	XGF-DC8A*	Current, 8ch
Analog input/output	XGF-DV4S*	Voltage, 4ch, Insulation
	XGF-DC4S*	Current, 4ch, Insulation
Analog input/output	XGF-AH6A*	Input: 4ch, Voltage/ Current Output: 2Ch Voltage/ Current
HART I/F Analog input/output	XGF-AC4H	Input: 4ch
	XGF-DC4H	Output: 4Ch
High speed counter	XGF-HO2A*	Open collector, 2ch
	XGF-HD2A*	Line drive, 2ch
	XGF-HO8A*	8-channels high speed counter module, 8Ch
Positioning	XGF-P01H-P04H	Open collector, 1~4axis
	XGF-PD1H-PD4H	Line drive, 1~4axis
Positioning (Network type)	XGF-PN8A	LS ELECTRIC EtherCAT Network, 8axis
	XGF-PN8B	Standard EtherCAT Network, 8axis
	XGF-PN4B	Standard EtherCAT Network, 4axis
Motion control	XGF-M16M	MECHATROLINK-II, 4axis
	XGF-M32E	Standard EtherCAT, 32axes
Temperature input	XGF-RD8A	RTD, 8ch
	XGF-RD4A*	RTD, 4ch
	XGF-RD4S*	RTD, 4ch, Insulation
	XGF-TC4S*	Thermo couple, 4ch, Insulation
Temperature controller	XGF-TC4UD	Input: 4Ch(Voltage/Cuttent/RTD/TC) Output: 8Ch(TR/Current) 4loops
	XGF-TC4RT	Input:4Ch(RTD) Output: 4Ch(TR) 4loops
Event input	XGF-SOEA	DC24V, 32points
Datalog	XGF-DL16A	USB 2.0, CF2001, Max. 16Gbyte, 32points(input 22points, output 10points)

* : G3 Coating Products

Communication module

RAPIEnet+ -RAPIEnet v2 -Ethernet/IP -Modbus TCP/IP -Dedicated XGT Network	XGL-EFMTB*	Master/Client, Twisted fair 2ch.
	XGL-EFMFB*	Master/Client, Fiber optic 2ch.
	XGL-EFMHB*	Master/Client, Twisted fair/fiber optic
	XGL-DBDT	Expansion driver-Twisted pair 2ch.
	XGL-DBDF	Expansion driver-Fiber optic 2ch.
	XGL-DBDH	Expansion driver-Fiber optic/Twisted pair
	XGL-ES4T	Stand alone switch twisted pair 4ch.
	XGL-ES4H	Stand alone switch twisted 2ch. fiber 2ch.
	XGL-EH5T	Open Ethernet switching hub
Computer Link (Cnet)	XGL-CH2B*	RS-232C 1ch, RS-422/485 1ch
	XGL-C22B*	RS-232C 2ch
	XGL-C42B*	RS-422/485 2ch
DeviceNet(Dnet)	XGL-DMEB*	DeviceNet, Master
Profibus-DP (Pnet)	XGL-PMEB*	Profibus-DP, Master
	XGL-PSRA	Profibus-DP Slave, Remote interface
	XGL-PSEA	Profibus-DP Slave
Rnet	XGL-RMEB*	Rnet, Master, TP
	GOL-RR8T	Rnet stand alone repeater hub
Fnet	XGL-FMEA	Fnet, Master
BACnet/IP	XGL-BIPT	BACnet client/server
RAPIEnet V1	XGL-EIMT	RAPIEnet, Twisted fait 2ch
	XGL-EIMF	RAPIEnet, Fiber optic 2ch
	XGL-EIMH	RAPIEnet, Twisted fair, Fiber optic
EtherNet/IP	XGL-EIPT	Industrial Ethernet, Twisted fair 2ch

* : G3 Coating Products

XGR module

CPU	XGR-CPUH/T*	Twisted pair
	XGR-CPUH/F	Fiber optic(2km)
	XGR-CPUH/S	Fiber optic(15km)
Power	XGR-AC12*	110V, 5.5A(Main base)
	XGR-AC13*	110V, 8.5A(Expansion base)
	XGR-AC22*	220V, 5.5A(Main base)
	XGR-AC23*	220V, 8.5A(Expansion base)
	XGR-DC42*	DC24V/DC5V 7A, Main(Expansion base)
	Base	XGR-M06P*
XGR-M02P*		2Slot(Main base)
XGR-E08P		8Slot(Expansion base)
XGR-E12P*		12Slot(Expansion base)
XGR-E12H*		12Slot(Expansion base, Drive Redundancy)
Expansion drive	XGR-DBST*	Twisted pair - Twisted
	XGR-DBSF*	Pair Fiber optic - Fiber optic(2km)
	XGR-DBSH*	Twisted pair - Fiber optic(2km)
	XGR-DBSFS	Pair Fiber optic - Fiber optic(15km)
	XGR-DBSHS	Twisted pair - Fiber optic(15km)
Expansion drive redundancy	XGR-DBDT	Twisted pair - Twisted
	XGR-DBDF	Pair Fiber optic - Fiber optic(2km)
	XGR-DBDH	Twisted pair - Fiber optic(2km)

* : G3 Coating Products

CPU	Product	Description
Expansion cable	XGC-E041	0.4m
	XGC-E061	0.6m
	XGC-E121	1.2m
	XGC-E301	3.0m
	XGC-E501	5.0m
	XGC-E102	10m
	XGC-E152	15m
Termination connector	XGT-TERA	Termination connector for expansion base download cable
USB cable	USB-301A	USB download cable
RS232C cable	K1C-050A	RS232C download cable
Sync & Expansion cable	XGC-F201	2m (Fiber optic)
	XGC-F501	5m (Fiber optic)
Dummy	XGT-DMMA	Dummy module
	XGR-DMMA	Dummy module

Dimensions

• Base

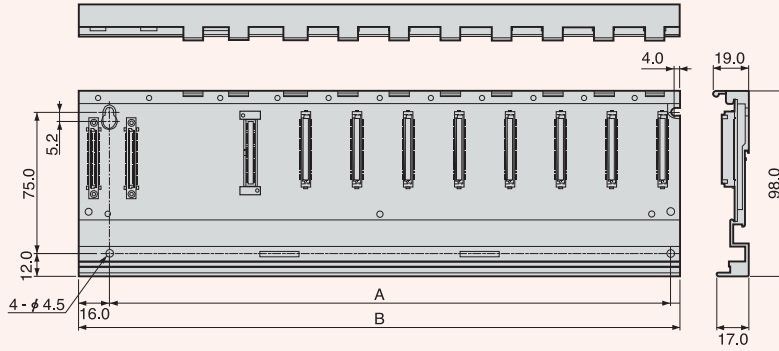

• Power module

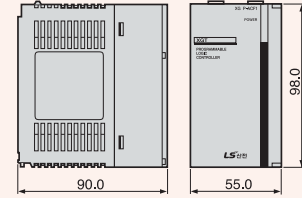

• CPU and I/O module

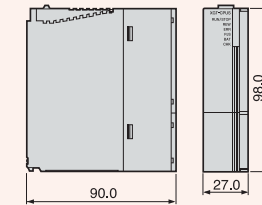

Base Dimensions (W)

Item	XGB-M04A/E04A	XGB-M06A/E06A	XGB-M08A/E08A	XGB-M10A	XGB-M12A/E12A
A	190	244	298	356	406
B	210	264	318	375	426

• Base base

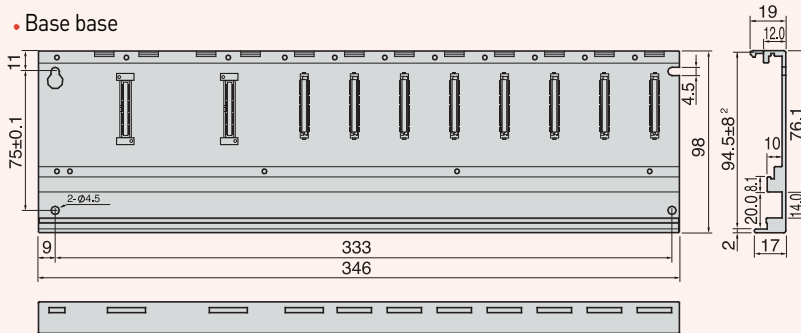

• Expansion base

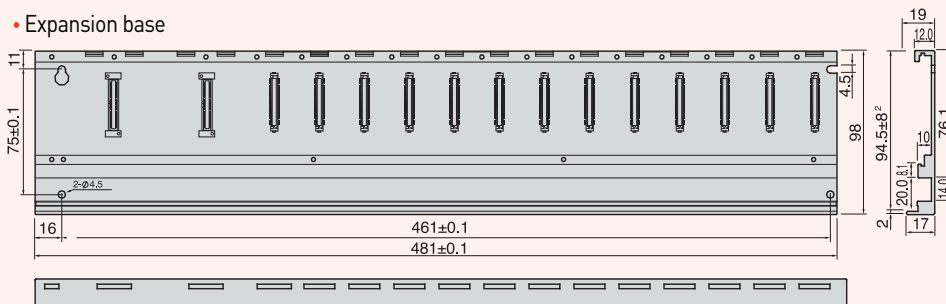

• Power and CPU

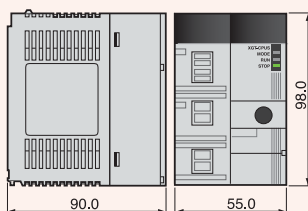

• I/O

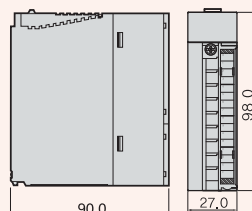

Base Dimensions (W)

Item	XGR-M06P	XGR-E08P	XGR-E12P
A	333	353	461
B	346	373	481

SOLUTION SQUARE

EVERYTHING ABOUT AUTOMATION ENGINEERING

How can I get information on LS ELECTRIC Automation Technology?



SOLUTION SQUARE provides technical information and training materials across a wide range of automation technologies.

SOLUTION SQUARE

Engineering Software-associated Services

Linked with Automation Software

Users can access graphic libraries and samples in the engineering software in a few clicks.



Simple Software Updates

Check the latest information and keep your software up-to-date.



Quick and Easy Search for Automation Technologies

Getting Effective Search Results

Quick and easy search for up-to-date content of products and technologies



Mobile Friendly

Optimized for web and mobile



Search on Google. Visit at sol.ls-electric.com





Safety Instructions

- For your safety, please read user's manual thoroughly before operating.
- Contact the nearest authorized service facility for examination, repair, or adjustment.
- Please contact qualified service technician when you need maintenance. Do not disassemble or repair by yourself!
- Any maintenance and inspection shall be performed by the personnel having expertise concerned.



- According to The WEEE Directive, please do not discard the device with your household waste.



www.ls-electric.com

■ Headquarter

LS-ro 127(Hogye-dong) Dongan-gu, Anyang-si, Gyeonggi-Do, 14119, Korea

■ Seoul Office

LS Yongsan Tower, 92, Hangang-daero, Yongsan-gu, Seoul, 04386, Korea
Tel: 82-2-2034-4033, 4888, 4703 Fax: 82-2-2034-4588
E-mail: automation@ls-electric.com

■ Overseas Subsidiaries

- **LS ELECTRIC Japan Co., Ltd. (Tokyo, Japan)**
Tel: 81-3-6268-8241 E-Mail: japan@ls-electric.com
- **LS ELECTRIC (Dalian) Co., Ltd. (Dalian, China)**
Tel: 86-411-8730-6495 E-Mail: china.dalian@lselectric.com.cn
- **LS ELECTRIC (Wuxi) Co., Ltd. (Wuxi, China)**
Tel: 86-510-6851-6666 E-Mail: china.wuxi@lselectric.com.cn
- **LS ELECTRIC Middle East FZE (Dubai, U.A.E.)**
Tel: 971-4-886-5360 E-Mail: middleeast@ls-electric.com
- **LS ELECTRIC Europe B.V. (Hoofddorp, Netherlands)**
Tel: 31-20-654-1424 E-Mail: europartner@ls-electric.com
- **LS ELECTRIC America Inc. (Chicago, USA)**
Tel: 1-800-891-2941 E-Mail: sales.us@lselectricamerica.com
- **LS ELECTRIC Türkiye Co., Ltd.**
Tel: 90-212-806-1225 E-Mail: Türkiye@ls-electric.com

■ Overseas Branches

- **LS ELECTRIC Tokyo Office (Japan)**
Tel: 81-3-6268-8241 E-Mail: tokyo@ls-electric.com
- **LS ELECTRIC Beijing Office (China)**
Tel: 86-10-5095-1631 E-Mail: china.auto@lselectric.com.cn
- **LS ELECTRIC Shanghai Office (China)**
Tel: 86-21-5237-9977 E-Mail: china.auto@lselectric.com.cn
- **LS ELECTRIC Guangzhou Office (China)**
Tel: 86-20-3818-2883 E-Mail: china.auto@lselectric.com.cn
- **LS ELECTRIC Chengdu Office (China)**
Tel: 86-28-8670-3201 E-Mail: china.auto@lselectric.com.cn
- **LS ELECTRIC Qingdao Office (China)**
Tel: 86-532-8501-2065 E-Mail: china.auto@lselectric.com.cn
- **LS ELECTRIC Nanjing Office (China)**
Tel: 86-25-8467-0005 E-Mail: china.auto@lselectric.com.cn
- **LS ELECTRIC Bangkok Office (Thailand)**
Tel: 66-90-950-9683 E-Mail: thailand@ls-electric.com
- **LS ELECTRIC Jakarta Office (Indonesia)**
Tel: 62-21-2933-7614 E-Mail: indonesia@ls-electric.com
- **LS ELECTRIC Moscow Office (Russia)**
Tel: 7-499-682-6130 E-Mail: info@lselectric-ru.com
- **LS ELECTRIC America Western Office (Irvine, USA)**
Tel: 1-949-333-3140 E-Mail: america@ls-electric.com
- **LS ELECTRIC Italy office (Italy)**
Tel: 39-030-8081-833 E-Mail: italia@ls-electric.com