

ø6·7·8·9·10 UP Series Miniature Pilot Lights

Available in Various Sizes

- Five illumination colors: amber, green, red, white, yellow
- Various sizes and design.
- Available with a built-in current limiting resistor.
- Degree of protection: IP65 (ø9 and ø10)
- Panel thickness 0.6 to 4 mm (built-in current limiting resistor type 0.6 to 6 mm)

Specifications

Without a Built-in Current Limiting Resistor

Color Code	A (amber), G (Green), R (Red), W (white), Y (yellow)
Rated Current	10 mA (Amber, Green, Red, Yellow) 15 mA (White)
Forward Current	20 mA maximum at 25°C
Reverse Voltage	3V maximum at 25°C
Power Consumption	60 mW maximum at 25°C
Operating Temperature	-20 to +55°C
Storage Temperature	-25 to +80°C
Forward Voltage	Maximum value: 3V Standard value: 2V (forward current: 10 mA)
Dielectric Strength	Between live and dead parts: 500V AC, 1 minute

- Approx. 30,000 hours (until the brightness reduces to 50% of the initial value when lit at complete direct current the rated voltage under 25°C environment.)

With a Built-in Current Limiting Resistor

Color Code	A (amber), G (Green), R (Red), W (white), Y (yellow)
Operating Voltage	12V DC±10%, 24V DC±10%
Rated Current	15 mA
Operating Temperature	-20 to +55°C (no freezing)
Storage Temperature	-25 to +80°C (no freezing)
Operating Humidity	45 to 85% RH (no condensation)
Dielectric Strength	Between live and dead parts: 500V AC, 1 minute

- Approx. 30,000 hours (until the brightness reduces to 50% of the initial value when lit at complete direct current the rated voltage under 25°C environment.)



Panel Cut-out

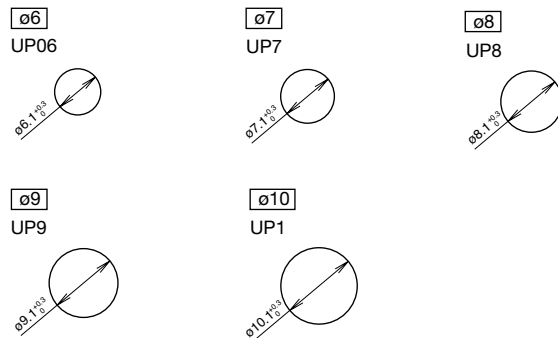







All dimensions in mm.

Weight (example)

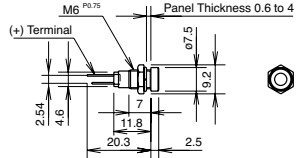

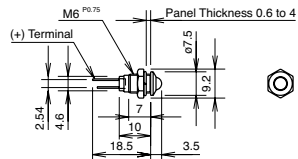

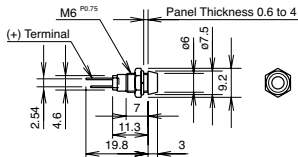







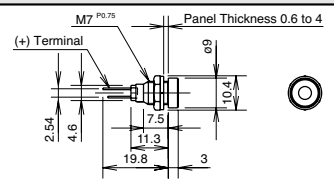

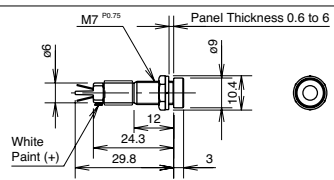

Weight (approx.)	2g (UP06-67)
	5g (UP7-1277)
	6g (UP8-2487)
	7g (UP9-2497)
	8g (UP1-2417)

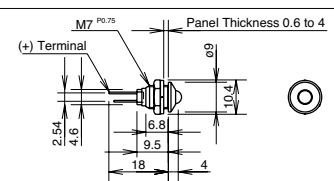
ø6 UP06 Series

Shape	Operating Voltage	Degree of Protection	Part No.	Ordering No.	Color Code	Dimensions	Package Quantity
 (+)  (-)	—	IP65	UP06-67②	UP06-67②	Specify a color code in place of ② in the Part No. A: amber G: green R: red W: white Y: yellow		1
				UP06-67②PN10			10
 (+)  (-)	—	IP40	UP06-68②	UP06-68②			1
				UP06-68②PN10			10
 (+)  (-)	—	IP65	UP06-69②	UP06-69②			1
				UP06-69②PN10			10

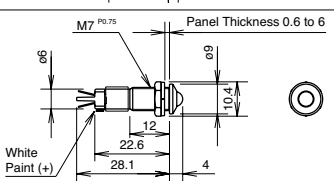

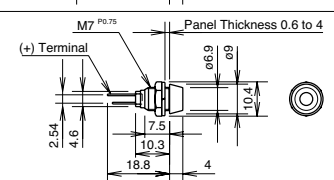
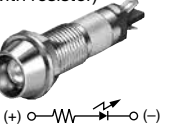

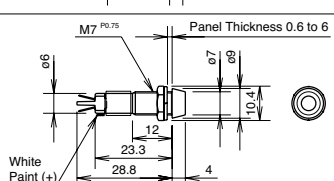



Note: For UP series pilot lights without built-in current limiting resistors, connect an external resistor in series. Otherwise, the LED may be damaged.

ø7 UP7 Series

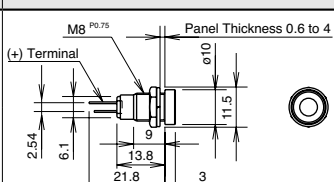
Shape	Operating Voltage	Degree of Protection	Part No.	Ordering No.	Color Code	Dimensions	Package Quantity	
 (+) o  o (-)	-	IP40	UP7-77②	UP7-77②	Specify a color code in place of ② in the Part No. A: amber G: green R: red W: white Y: yellow		1	
				UP7-77②PN10			10	
 (+) o   o (-)	12V DC ±10%		UP7-1277②	UP7-1277②			1	
	24V DC ±10%			UP7-1277②PN10			10	
				UP7-2477②			UP7-2477②	1
							UP7-2477②PN10	10
 (+) o  o (-)	-		UP7-78②	UP7-78②			1	
				UP7-78②PN10			10	
 (+) o   o (-)	12V DC ±10%		UP7-1278②	UP7-1278②			1	
	24V DC ±10%			UP7-1278②PN10			10	
				UP7-2478②			UP7-2478②	1
							UP7-2478②PN10	10
 (+) o  o (-)	-	UP7-79②	UP7-79②		1			
			UP7-79②PN10		10			
 (+) o   o (-)	12V DC ±10%	UP7-1279②	UP7-1279②		1			
	24V DC ±10%		UP7-1279②PN10		10			
			UP7-2479②		UP7-2479②	1		
					UP7-2479②PN10	10		

Note: For UP series pilot lights without built-in current limiting resistors, connect an external resistor in series. Otherwise, the LED may be damaged.

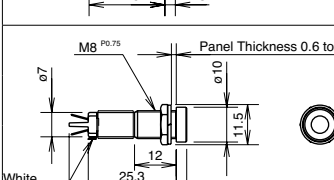
ø8 UP8 Series

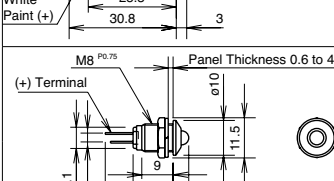
Shape	Operating Voltage	Degree of Protection	Part No.	Ordering No.	Color Code	Dimensions (mm)	Package Quantity	
 (+) o  o (-)	-	IP40	UP8-87②	UP8-87②	Specify a color code in place of ② in the Part No. A: amber G: green R: red W: white Y: yellow		1	
				UP8-87②PN10			10	
 (+) o   o (-)	12V DC ±10%		UP8-1287②	UP8-1287②			1	
	24V DC ±10%			UP8-1287②PN10			10	
				UP8-2487②			UP8-2487②	1
							UP8-2487②PN10	10
 (+) o  o (-)	-		UP8-88②	UP8-88②			1	
				UP8-88②PN10			10	

Note: For UP series pilot lights without built-in current limiting resistors, connect an external resistor in series. Otherwise, the LED may be damaged.

Instructions

Polarity

Pay attention to the polarity of the power supply as UP series units do not contain a diode for protection against reverse polarity. On solder terminal units, the terminal with a white paint marking is positive. On wire-wrap terminal units, the long terminal is positive and the short terminal is negative.

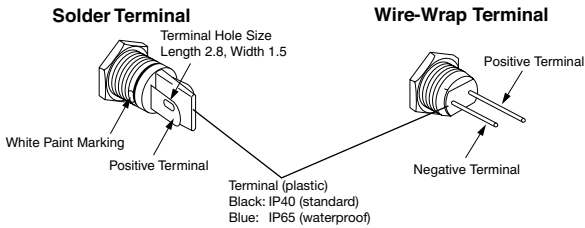

Current Limiting Resistor

When using a UP series unit without a built-in current limiting resistor, connect an external current limiting resistor. Calculate the resistance using the following formula.

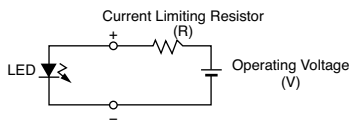

$$\text{Resistance (R)} = \frac{\text{Operating Voltage (V)} - 2}{\text{Rated Current (I)} *}$$

* Rated Current (I) = 10 mA, except white color at 15 mA

Note: Use a resistor of higher resistance than the calculated value (R).

$$\text{Rated Wattage of Resistor (W)} = \text{Rated Current (I)} \times \text{Operating Voltage (V)} \times 2 \text{ to } 3 *$$

* 2 to 3 is a safety factor

Reference Value of Current Limit Resistor

Color	Amber, Green, Red, Yellow	White
5V DC	300Ω (1/4W)	200Ω (1/4W)
6V DC	390Ω (1/4W)	270Ω (1/4W)
12V DC	1000Ω (1/4W)	680Ω (1/4W)
24V DC	2200Ω (1/2W)	1500Ω (1/2W)

Waterproof Type

The degree of protection is distinguished by the color of the terminal.

Terminal (Plastic)	Degree of Protection
Black	IP40
Blue	IP65

Wiring

Solder the terminal at 350°C within 3 seconds using a 60W soldering iron. SnAgCu type lead-free solder is recommended. When soldering, do not touch the pilot light housing with the terminal. Do not bend the terminal or apply excessive force to the terminal.

Notes on Operating Voltage

The rated operating voltage represents a complete DC value. When using a pulsating voltage such as a full-wave rectification voltage, keep peak currents within the forward current I_f. Peak currents exceeding I_f may shorten the life of the LED lamp.

Panel Mounting

When mounting UP series units on to the panel, refer to the table below for the recommended tightening torque. Do not tighten with excessive force, otherwise the locking ring will be damaged.

Model	Recommended Tightening Torque
UP06	0.29 N·m
UP7	0.39 N·m
UP8	0.49 N·m
UP9	0.59 N·m
UP9P	0.29 N·m
UP1	0.59 N·m
UP1P	0.29 N·m

UP Series Miniature Pilot Lights (Single Board Mounting)

Single board mounting for miniature LEDs. Same length as H6, L6, and LW series control units

- Five illumination colors: amber, green, red, white, yellow

Specifications

Rated Current	10 mA (Amber, Green, Red, Yellow) 15 mA (White)
Forward Current	20 mA maximum at 25°C
Reverse Voltage	3V maximum at 25°C
Power Consumption	60 mW maximum at 25°C
Operating Temperature	-20 to +55°C (no freezing)
Storage Temperature	-25 to +80°C (no freezing)
Forward Voltage	Maximum value: 3V Standard value: 2V (forward current: 10 mA)
Dielectric Strength	Between live and dead parts: 500V AC, 1 minute
Weight (approx.)	6g (UP8-89V)



ø8 ø9 ø10 UP8 / UP9P / UP1P

Mounting Hole Size	Shape	Degree of Protection	Part No.	Ordering No.	Color Code	Package Quantity
ø8 UP8	Deep shroud	IP40	UP8-89V②	UP8-89V②PN10	A: amber	10
ø9 UP9	Deep shroud	IP65	UP9P-99V②	UP9P-99V②PN10	G: green	10
ø10 UP1P	Deep shroud	IP65	UP1P-19V②	UP1P-19V②PN10	R: red W: white Y: yellow	10

•Specify a color code in place of ② in the Part No.

Note: Connect an external current limiting resistor in series. Otherwise, the LED may be damaged.

Dimensions

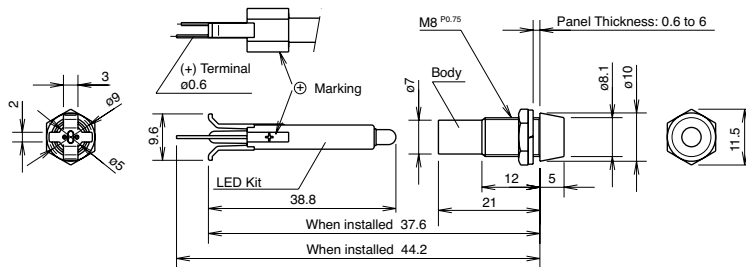

UP8-89V

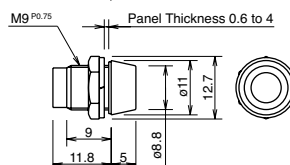

UP9-99V

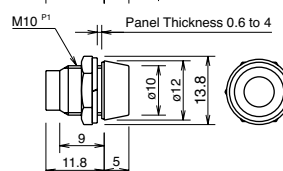

UP1P-19V

All dimensions in mm.

PC Board Mounting Hole

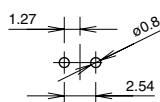

Panel Cut-out

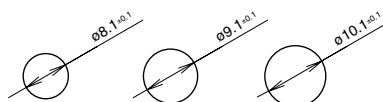

Internal Circuit

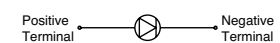

The longer pin is the positive terminal

Safety Precautions

• Turn off power to the unit before installation, removal, wiring, maintenance, and inspection. Failure to turn off may cause electrical shocks or fire hazard.

• For wiring, use wires of a proper size to meet the voltage and current requirements. Improper soldering or failure to tighten the terminal screw may cause overheating and fire.

Instructions

Single Board Mounting

UP series miniature pilot light single board mounting types can be mounted with H6, L6, LW series control units on the same panel. Follow the instructions below on single board mounting.

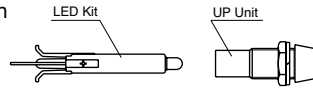

1. Mount the LED kit to the PC board.

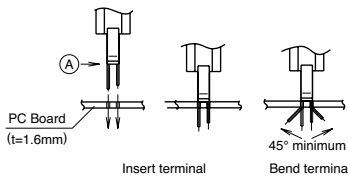

- Temporary mounting
- 1. Note the polarity of the terminals and insert the terminals to the PC board.
- 2. Make sure that part A of the LED kit is pressed tightly to the PC board. Bend the terminals sideways as shown on the left.

2. Mount the operator and the UP series pilot lights on to the control panel.

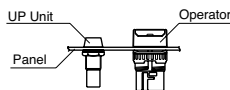

3. Mount the contact block to the operator of the miniature control unit and lock the unit by turning the locking lever.

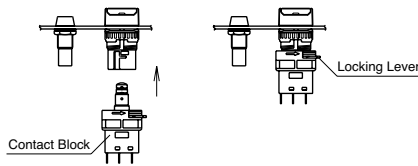

4. Install the PC board in 1. to the panel in 3.

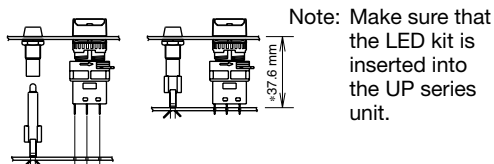

5. Solder the terminals.

Before soldering, make sure that each terminal of the contact block is securely inserted into the PC board holes.

* When mounting H6, L6, LW, and UP series on a single board, make sure that the distance between the front of the panel and the mounting side of the PC board is 37.6 mm.

Polarity

Pay attention to the polarity of the power supply as UP series units do not contain a diode for protection against reverse polarity. The long terminal is positive and the short terminal is negative.

Current Limiting Resistor

When using a UP series unit without a built-in current limiting resistor, connect an external current limiting resistor. Calculate the resistance using the following formula.

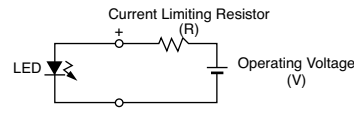

$$\text{Resistance (R)} = \frac{\text{Operating Voltage (V)} - 2}{\text{Rated Current (I)} *}$$

* Rated Current (I) = 10 mA, except white color at 15 mA

Note: Use a resistor of higher resistance than the calculated value (R).

$$\text{Rated Wattage of Resistor (W)} = \text{Rated Current (I)} \times \text{Operating Voltage (V)} \times 2 \text{ to } 3 *$$

* 2 to 3 is a safety factor

Current Limiting Resistor Reference Value

Color	Amber, Green, Yellow, Amber	White
Operating Voltage		
5V DC	300Ω (1/4W)	200Ω (1/4W)
6V DC	390Ω (1/4W)	270Ω (1/4W)
12V DC	1000Ω (1/4W)	680Ω (1/4W)
24V DC	2200Ω (1/2W)	1500Ω (1/2W)

Wiring

Solder the terminal at 350°C within 3 seconds using a 60W soldering iron. SnAgCu type lead-free solder is recommended. When soldering, do not touch the pilot light housing with the terminal. Do not bend the terminal or apply excessive force to the terminal.

Notes on Panel Mounting

Use an optional locking ring wrench to mount the unit onto a panel. Tightening torque should not exceed 0.5 N·m. Do not use pliers. Do not tighten with excessive force, otherwise the locking ring will be damaged.

PC Board and Circuit Design

Use glass epoxy copper clad laminate, double-sided through-hole PC boards with a thickness of 1.6 mm.

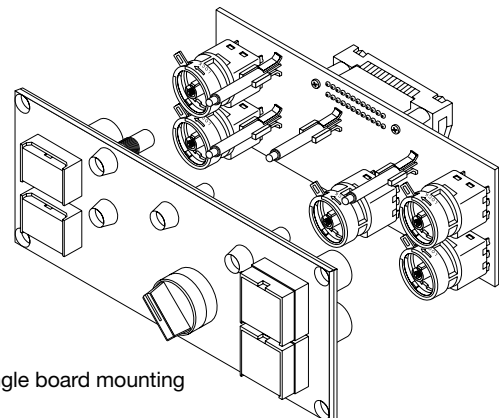

Example of single board mounting

Ordering Terms and Conditions

Thank you for using IDEC Products.

By purchasing products listed in our catalogs, datasheets, and the like (hereinafter referred to as "Catalogs") you agree to be bound by these terms and conditions. Please read and agree to the terms and conditions before placing your order.

1. Notes on contents of Catalogs

- (1) Rated values, performance values, and specification values of IDEC products listed in this Catalog are values acquired under respective conditions in independent testing, and do not guarantee values gained in combined conditions.
Also, durability varies depending on the usage environment and usage conditions.
- (2) Reference data and reference values listed in Catalogs are for reference purposes only, and do not guarantee that the product will always operate appropriately in that range.
- (3) The specifications / appearance and accessories of IDEC products listed in Catalogs are subject to change or termination of sales without notice, for improvement or other reasons.
- (4) The content of Catalogs is subject to change without notice.

2. Note on applications

- (1) If using IDEC products in combination with other products, confirm the applicable laws / regulations and standards.
Also, confirm that IDEC products are compatible with your systems, machines, devices, and the like by using under the actual conditions. IDEC shall bear no liability whatsoever regarding the compatibility with IDEC products.
- (2) The usage examples and application examples listed in Catalogs are for reference purposes only. Therefore, when introducing a product, confirm the performance and safety of the instruments, devices, and the like before use. Furthermore, regarding these examples, IDEC does not grant license to use IDEC products to you, and IDEC offers no warranties regarding the ownership of intellectual property rights or non-infringement upon the intellectual property rights of third parties.
- (3) When using IDEC products, be cautious when implementing the following.
 - i. Use of IDEC products with sufficient allowance for rating and performance
 - ii. Safety design, including redundant design and malfunction prevention design that prevents other danger and damage even in the event that an IDEC product fails
 - iii. Wiring and installation that ensures the IDEC product used in your system, machine, device, or the like can perform and function according to its specifications
- (4) Continuing to use an IDEC product even after the performance has deteriorated can result in abnormal heat, smoke, fires, and the like due to insulation deterioration or the like. Perform periodic maintenance for IDEC products and the systems, machines, devices, and the like in which they are used.
- (5) IDEC products are developed and manufactured as general-purpose products for general industrial products. They are not intended for use in the following applications, and in the event that you use an IDEC product for these applications, unless otherwise agreed upon between you and IDEC, IDEC shall provide no guarantees whatsoever regarding IDEC products.
 - i. Use in applications that require a high degree of safety, including nuclear power control equipment, transportation equipment (railroads / airplanes / ships / vehicles / vehicle instruments, etc.), equipment for use in outer space, elevating equipment, medical instruments, safety devices, or any other equipment, instruments, or the like that could endanger life or human health
 - ii. Use in applications that require a high degree of reliability, such as provision systems for gas / waterworks / electricity, etc., systems that operate continuously for 24 hours, and settlement systems
 - iii. Use in applications where the product may be handled or used deviating from the specifications or conditions / environment listed in the Catalogs, such as equipment used outdoors or applications in environments subject to chemical pollution or electromagnetic interference
If you would like to use IDEC products in the above applications, be sure to consult with an IDEC sales representative.

3. Inspections

We ask that you implement inspections for IDEC products you purchase without delay, as well as thoroughly keep in mind management/maintenance regarding handling of the product before and during the inspection.

4. Warranty

- (1) Warranty period
The warranty period for IDEC products shall be one (1) year after purchase or delivery to the specified location. However, this shall not apply in cases where there is a different specification in the Catalogs or there is another agreement in place between you and IDEC.
- (2) Warranty scope
Should a failure occur in an IDEC product during the above warranty period for reasons attributable to IDEC, then IDEC shall replace or repair that product, free of charge, at the purchase location / delivery location of the product, or an IDEC service base. However, failures caused by the following reasons shall be deemed outside the scope of this warranty.
 - i. The product was handled or used deviating from the conditions / environment listed in the Catalogs
 - ii. The failure was caused by reasons other than an IDEC product
 - iii. Modification or repair was performed by a party other than IDEC
 - iv. The failure was caused by a software program of a party other than IDEC
 - v. The product was used outside of its original purpose
 - vi. Replacement of maintenance parts, installation of accessories, or the like was not performed properly in accordance with the user's manual and Catalogs
 - vii. The failure could not have been predicted with the scientific and technical standards at the time when the product was shipped from IDEC
 - viii. The failure was due to other causes not attributable to IDEC (including cases of force majeure such as natural disasters and other disasters)Furthermore, the warranty described here refers to a warranty on the IDEC product as a unit, and damages induced by the failure of an IDEC product are excluded from this warranty.

5. Limitation of liability

The warranty listed in this Agreement is the full and complete warranty for IDEC products, and IDEC shall bear no liability whatsoever regarding special damages, indirect damages, incidental damages, or passive damages that occurred due to an IDEC product.

6. Service scope

The prices of IDEC products do not include the cost of services, such as dispatching technicians. Therefore, separate fees are required in the following cases.

- (1) Instructions for installation / adjustment and accompaniment at test operation (including creating application software and testing operation, etc.)
- (2) Maintenance inspections, adjustments, and repairs
- (3) Technical instructions and technical training
- (4) Product tests or inspections specified by you

The above content assumes transactions and usage within your region. Please consult with an IDEC sales representative regarding transactions and usage outside of your region. Also, IDEC provides no guarantees whatsoever regarding IDEC products sold outside your region.

IDEC CORPORATION

Head Office

6-64, Nishi-Miyahara-2-Chome, Yodogawa-ku, Osaka 532-0004, Japan

USA	IDEC Corporation	Tel: +1-408-747-0550	opencontact@idec.com
Germany	APEM GmbH	Tel: +49-40-25 30 54-0	service@eu.idec.com
Singapore	IDEC Izumi Asia Pte. Ltd.	Tel: +65-6746-1155	info@sg.idec.com
Thailand	IDEC Asia (Thailand) Co., Ltd	Tel: +66-2-392-9765	sales@th.idec.com
India	IDEC Controls India Private Limited	Tel: +91-80679-35328	info_india@idec.com
Taiwan	IDEC Taiwan Corporation	Tel: +886-2-2577-6938	service@tw.idec.com

Hong Kong	IDEC Izumi (H.K.) Co., Ltd.	Tel: +852-2803-8989	info@hk.idec.com
China	IDEC (Shanghai) Corporation	Tel: +86-21-6135-1515	idec@cn.idec.com
	Beijing Branch	Tel: +86-10-6581-6131	idec@cn.idec.com
	Guangzhou Branch	Tel: +86-20-8362-2394	idec@cn.idec.com
Japan	IDEC Corporation	Tel: +81-6-6398-2527	jp_marketing@idec.com

 www.idec.com

Specifications and other descriptions in this brochure are subject to change without notice.

