

ø25 TWS Series Switches & Pilot Lights

General-purpose switches & pilot lights for various applications
Heavy-duty type for high-level protection against harsh environment

- No terminal cover required (except for full voltage pilot lights)
- Easy wiring for crimping terminal.
- Six different colors with a single LED (LSRD)
Previously, 5 different color LEDs were required but with the new illuminated unit, only a single LED is used.
- UL, CSA, TÜV, CCC compliant (except for some models).



- DC-DC converter types are not approved by standards.
- See website for details on approvals and standards.



Specifications and Ratings

Contact Ratings

Pushbuttons Illuminated Pushbuttons Selector Switches Illuminated Selector Switches	Rated insulation voltage	600V
	Rated continuous current	10A
	Contact ratings by utilization category IEC 60947-5-1	AC-15 (A600) DC-13

For the units listed below, the rated current (load switching current) is reduced to a half of the rated operational current of the contact block. The rated insulation voltage (600V) and the rated thermal current (10A) remain unchanged.
Selector switches and illuminated selector switches with contact code 2R, 3S, 4S, or 4R.

Contact Ratings by Utilization Category

HW-U10 (NO contact), HW-U01 (NC contact)

Operating Voltage		24V	48V	50V	110V	220V	440V
Operating Current	AC 50/60 Hz	AC-12 Control of resistive loads and solid state loads	10A	—	10A	10A	2A
		AC-15 Control of electromagnetic loads (> 72 VA)	10A	—	7A	5A	1A
	DC	DC-12 Control of resistive loads and solid state loads	10A	5A	—	2.2A	—
		DC-13 Control of electromagnets	5A	2A	—	1.1A	—

HW-U10R (EM contact/NO contact), HW-U01R (LB contact/NC contact)

Operating Voltage		24V	48V	50V	110V	220V	440V
Operating Current	AC 50/60 Hz	AC-12 Control of resistive loads and solid state loads	5A	—	5A	3A	1A
		AC-15 Control of electromagnetic loads (> 72 VA)	5A	—	3.5A	2.5A	0.5A
	DC	DC-12 Control of resistive loads and solid state loads	5A	2.5A	—	1.1A	—
		DC-13 Control of electromagnets	2.5A	1A	—	0.55A	—

- The operating current represents the classification by making and breaking currents (IEC 60947-5-1).
- Contact materials: Silver contacts
- Minimum applicable load: 3V AC/DC, 5 mA (applicable range may vary with operating conditions and load types)

HW-U Contact Block

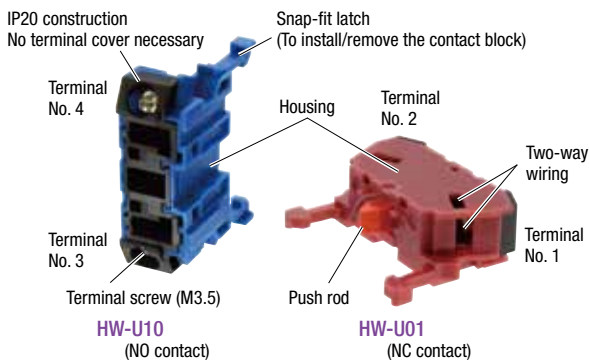

Part No.	HW-U10	HW-U01	HW-U10R	HW-U01R
Contact				
Contact	1NO	1NC	EM (NO) (early make)	LB (NC) (late break)
Contact No.	3-4	1-2	3-4	1-2
Housing	Blue	Purple red	Blue	Purple red
Push Rod	Green	Red	Black	White
Weight	Approx. 11g			





- Up to 2 layers (4 blocks) can be attached. AYS: 2 blocks (1 layer) maximum.
- Gold contacts available (gold-plated silver)

LED Illuminated Part Specifications

Unit	LED lamp			
	Rated Voltage	Operating Voltage		
Pilot light Illuminated pushbutton Illuminated selector switch	6V AC/DC	6V AC/DC	Lamp Base BA9S/13	Part No. LSRD-6
	12V AC/DC	12V AC/DC		LSRD-1
	24V AC/DC	24V AC/DC		LSRD-2
	100/110V AC	100/110V AC	±10%	LSRD-6
	115/120V AC	115/120V AC		
	200/220V AC	200/220V AC		
	230/240V AC	230/240V AC		
	380V AC	380V AC		
	400/440V AC	400/440V AC		
	480V AC	480V AC		
	110V DC	90 to 140V DC		

• See below for details on LED lamp ratings.

Illuminated Part Type and Shape

	Illuminated Unit	Illuminated Unit/Pilot Light			Pilot Light
Power Unit	Full voltage adapter	Transformer		DC-DC converter	Full voltage adapter (integrated)
Rated Voltage	6, 12, 24V AC/DC	100 to 240V AC	380V AC minimum	110V DC	6, 12, 24V AC/DC
Polarity	None	None	None	X1 (+) X2 (-)	None
Shape/Terminal					

LED Lamp Ratings

LSRD

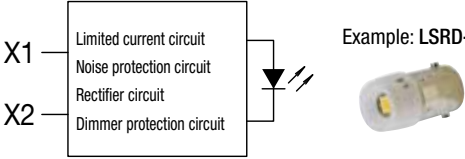
Part No.	LSRD-6	LSRD-1	LSRD-2
Lamp Base	BA9S/13		
Rated Voltage	6V AC/DC	12V AC/DC	24V AC/DC
Voltage Range	6V AC/DC ±10%		
Current Draw	DC	10 mA	7 mA
	AC	14 mA	8 mA
Voltage Marking	Die stamped on the base		
Life (reference value)	Approx. 50,000 hours (The luminance is reduced to 50% the initial intensity when used on complete DC at 25°C.)		
Internal Circuit	 <p>Example: LSRD-2</p>		
Weight	Approx. 2 g		

• Only one color is available for LSRD so there are no codes to specify the color in the part no.

Specifications

Operating Temperature		-25 to +50°C (no freezing)	
Operating Humidity		45 to 85% RH (no condensation)	
Storage Temperature		-40 to +80°C (no freezing)	
Contact Resistance		50 mΩ maximum (initial value)	
Insulation Resistance		100 MΩ minimum (500V DC megger)	
Dielectric Strength		Between live and dead metal parts: 2,500V AC, 1 minute (Full voltage and illuminated units: 2,000V AC, 1 minute)	
Vibration Resistance	Operating extremes	5 to 55 Hz, amplitude 0.5 mm	
	Damage limits	30 Hz, amplitude 1.5 mm	
Shock Resistance	Operating extremes	100 m/s ²	
	Damage limits	1,000 m/s ²	
Mechanical Life (minimum operations)	Pushbutton	Momentary	5,000,000
		Maintained	500,000 (3 contact blocks and over: 250,000)
		Push-to-lock, Turn-to-reset	500,000
		Other	500,000
	Illuminated pushbutton	Momentary	5,000,000
		Maintained	500,000 (3 contact blocks and over: 250,000)
		Push-to-lock, Turn-to-reset	500,000
	Selector switch		500,000
Key selector switch		500,000	
Illuminated selector switch		500,000	
Electrical Life (*4) (minimum operations)	Pushbutton	Momentary	500,000 (*1)
		Maintained	500,000 (3 contact blocks and over: 250,000) (*3)
		Push-to-lock, Turn-to-reset	500,000 (*3)
		Other	500,000
	Illuminated pushbutton	Momentary	500,000 (*1)
		Maintained	500,000 (3 contact blocks and over: 250,000) (*3)
		Push-to-lock, Turn-to-reset	500,000 (*3)
	Selector switch		500,000 (*2)
Key selector switch		500,000 (*2)	
Illuminated selector switch		250,000 (*2)	
Weight (Approx.)	Pushbutton		72 g (ABS122N)
	Pilot light		36 g (APS122DN)
	Illuminated pushbutton		97 g (ALS22222DN)
	Selector switch		76 g (ASS222N)
	Key selector switch		117 g (ASS2K22N)
	Illuminated selector switch		97 g (ASLS22222DN)

*1) Switching frequency 1,800 operations/h, duty ratio 40%

*2) Switching frequency 1,200 operations/h, duty ratio 40%

*3) Switching frequency 900 operations/h, duty ratio 40%

*4) Load condition 220V AC, 3A (AC-15)

Degree of Protection

	Unit	IEC 60529
A□□□□ (Part number that starts with "A")	Pushbutton Pilot light with round lens Illuminated pushbutton with round lens Selector switch	IP65
	Illuminated selector switch Key selector switch	IP54
U□□□□ (Part number that starts with "U")	Square pilot light Square flush illuminated pushbutton	IP40

For harsh environment such as torrid/frigid area

TWS series for harsh environment such as torrid/frigid area is also available (not approved by standards). Contact IDEC for details.

Mounting Hole Layout

All dimensions in mm.

Panel Cut (IEC60947-5-1)

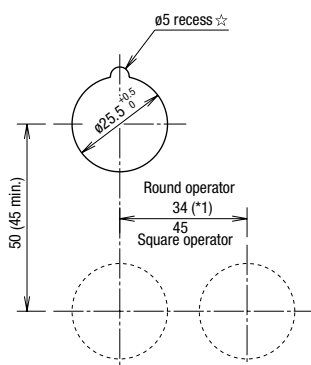

- The minimum mounting centers are applicable to switches with one layer of contact blocks (one to two contact blocks). When two layers of contact blocks are mounted, determine the minimum mounting centers in consideration of convenience for wiring.
 - 1*) ø35 mm mushroom button type: 35 mm minimum
 - 1*) ø42 mm mushroom button type: 42 mm minimum
 - 1*) 2-position, 3-position lever selector switch: 42 mm minimum
 - 1*) 4-position, 5-position lever selector switch: 50 mm minimum
- When high temperature is expected, take necessary measures such as securing sufficient mounting centers or using a cooling fan.
- The 5 mm recess is to prevent rattle and is necessary only when using a nameplate or an anti-rotation ring.

Ordering Information

Standard models

- Specify Ordering No. when ordering.
- Specify a button or lens color code in place of *.
- An LED lamp is installed in pilot lights, illuminated pushbuttons, and illuminated selector switches unless otherwise specified.
- Pilot light of full voltage adapter type is equipped with a terminal cover.
- Nameplates and accessories are ordered separately. See page 22 to 28.

- Color codes for units without LED lamps: R (red), G (green), A (amber), Y (yellow), S (blue)
- When using a commercially available lamp, choose a lamp with rated voltage 5 to 30V AC/DC and 1W maximum, and with the same base and shape.
- Make sure of correct operation before installation. The operation of TWS series cannot be guaranteed when a commercially available lamp is used.

Pushbuttons (Page 7 to 9)

When specifying gold-plated silver contact and contact configuration:

ABS 1	11	NR	-	MAU	
				Optional contact	MAU: Gold contact
				Contact configuration	10: 1NO
					01: 1NC
					11: 1NO1NC
					20: 2NO
					02: 2NC
					22: 2NO2NC
					40: 4NO
					04: 4NC
					13: 1NO3NC
					31: 3NO1NC
					30: 3NO
					03: 3NC
					12: 1NO2NC
					21: 2NO1NC

- Pushbuttons with 1 or 3 contact blocks have a dummy block.
- Push-pull type AYS3 (page 9) can have a maximum of two contact blocks.

Pilot Lights (Page 10 to 11)

When specifying LED operating voltage:

APS 1	126	DR	
			Operating voltage
			99: Without LED lamp
			66: 6V AC/DC
			11: 12V AC/DC
			22: 24V AC/DC
			16: 100/110V AC
			126: 115/120V AC
			26: 200/220V AC
			246: 230/240V AC
			386: 380V AC
			46: 400/440V AC
			486: 480V AC

- See page 8 for how to specify 110V DC type (DC-DC converter).

Ordering Information

Illuminated Pushbuttons (Page 12 to 14)

When specifying gold-plated silver contact, contact configuration, and LED operating voltage:

ALFS 2 126 13 DNR - MAU			
	Optional contact	MAU	Gold contact
	Contact configuration	10:	1NO
		01:	1NC
		11:	1NO1NC
		20:	2NO
		02:	2NC
		21:	2NO1NC
		12:	1NO2NC
		30:	3NO
		03:	3NC
		31:	3NO1NC
		22:	2NO2NC
		13:	1NO3NC
		40:	4NO
		04:	4NC
	Operating voltage	99:	Without LED lamp
		66:	6V AC/DC
		11:	12V AC/DC
		22:	24V AC/DC
		16:	100/110V AC
		126:	115/120V AC
		26:	200/220V AC
		248:	230/240V AC
		386:	380V AC
		46:	400/440V AC
		486:	480V AC

Note:

- Illuminated pushbuttons of 100V AC and over is not available with 1 or 3 contact blocks.
- Illuminated pushbuttons of 24V AC/DC and below with 2 or 4 contact blocks have a dummy block.
- See page 6 for how to specify 110V DC type (DC-DC converter).

Selector Switches (pages 15 to 16)

When specifying gold-plated silver contact, key removal position, and key number:

ASS 2 11 N -MAU		
	Optional contact	MAU: Gold-plated silver
	Contact arrangement codes	See page 19 to 21.

How to specify key removal/retained position

Position		Removable Position	Code	Part No. Example
2-position	Maintained	Removable in all positions	—	ASS2K11N
		Removable in left only	B	ASS2K11NB
		Removable in right only	C	ASS2K11NC
	Spring return from right	Removable in left only	—	ASS21K11N
	Spring return from left	Removable in right only	—	ASS22K11N
3-position	Maintained	Removable in all positions	—	ASS3K20N
		Removable in left and center only	B	ASS3K20NB
		Removable in right and center only	C	ASS3K20NC
		Removable in center only	D	ASS3K20ND
		Removable in right and left only	E	ASS3K20NE
		Removable in left only	G	ASS3K20NG
		Removable in right only	H	ASS3K20NH
		Spring return from right	Removable in left and center only	—
	Removable in center only		D	ASS31K20ND
	Removable in left only		G	ASS31K20NG
	Spring return from left	Removable in right and center only	—	ASS32K20N
		Removable in center only	D	ASS32K20ND
		Removable in right only	H	ASS32K20NH
		Spring return two-way	Removable in center only	—

- The key cannot be removed in a spring returned position.

Ordering Information

Illuminated selector switches (page 18)

When specifying gold-plated silver contact, contact configuration, and LED operating voltage:

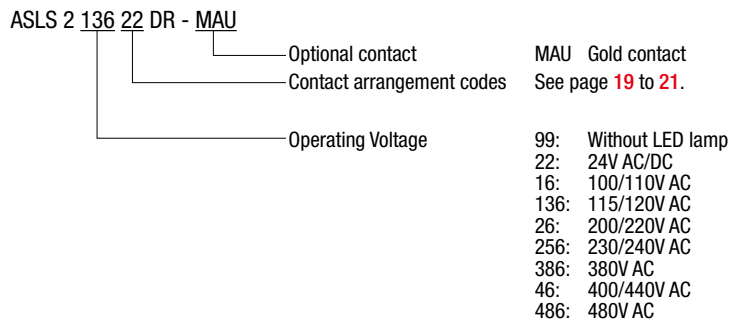

Note:

- Illuminated selector switches of 100V AC and over is not available with 1 or 3 contact blocks.
- Illuminated selector switches of 24V AC/DC and below with 2 or 4 contact blocks have a dummy block.
- See below for how to specify 110V DC type (DC-DC converter).

DC-DC Converter (110V DC)

When specifying illuminated pushbuttons, illuminated selector switches, and pilot lights:

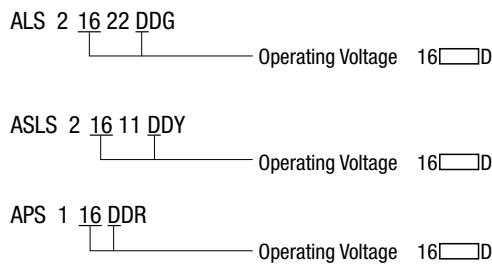





Note:

- DC-DC converter type (110V DC) is not approved by standards (90 to 140V DC).
- DC-DC converter type is not available with 1 or 3 contact blocks.

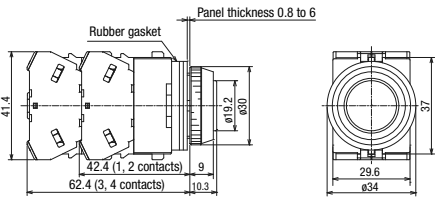
Flush / Extended / Extended with Full Shroud

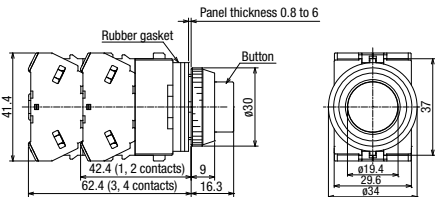
Package Quantity: 1

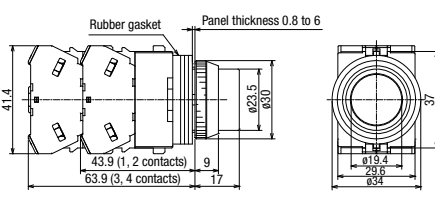



Shape	Operation	Contact	Part No.	Color Code	Dimensions (mm)
Flush ABS1 AOS1 	Momentary	1NO	ABS110N*	B G R Y S W Note	 <p>Note: The depth behind the panel of maintained unit is 1.5 mm longer than the momentary unit.</p>
		1NC	ABS101N*		
		1NO-1NC	ABS111N*		
		2NO	ABS120N*		
		2NC	ABS102N*		
		2NO-2NC	ABS122N*		
	Maintained	1NO	AOS110N*		
		1NC	AOS101N*		
		1NO-1NC	AOS111N*		
		2NO	AOS120N*		
		2NC	AOS102N*		
		2NO-2NC	AOS122N*		
Extended ABS2 AOS2 	Momentary	1NO	ABS210N*	B G R Y S W	 <p>Note: The depth behind the panel of maintained unit is 1.5 mm longer than the momentary unit.</p>
		1NC	ABS201N*		
		1NO-1NC	ABS211N*		
		2NO	ABS220N*		
		2NC	ABS202N*		
		2NO-2NC	ABS222N*		
	Maintained	1NO	AOS210N*		
		1NC	AOS201N*		
		1NO-1NC	AOS211N*		
		2NO	AOS220N*		
		2NC	AOS202N*		
		2NO-2NC	AOS222N*		
Extended with Full Shroud ABFS2 Aofs2 	Momentary	1NO	ABFS210N*	B G R Y S W	 <p>Note: The depth behind the panel of maintained unit is 1.5 mm longer than the momentary unit.</p>
		1NC	ABFS201N*		
		1NO-1NC	ABFS211N*		
		2NO	ABFS220N*		
		2NC	ABFS202N*		
		2NO-2NC	ABFS222N*		
	Maintained	1NO	Aofs210N*		
		1NC	Aofs201N*		
		1NO-1NC	Aofs211N*		
		2NO	Aofs220N*		
		2NC	Aofs202N*		
		2NO-2NC	Aofs222N*		

- Specify a color code in place of * in Part No. B (black), G (green), R (red), Y (yellow), S (blue), W (white)
- Round bezel and shroud (metal): Chrome-plated
- Pushbuttons with 1 or 3 contact blocks have a dummy block.
- See page 4 for other contact configurations and gold-plated silver contacts.
- Terminal screws: M3.5
- Integrated terminal cover
- See page 9 for bottom view.

Note ABS1, AOS1 with button color of B (black), G (green), or (R) red
 Supply of color buttons B, G, R has been discontinued for ABS1/AOS1 without color code.
 When ordering, make sure to specify the required button code.

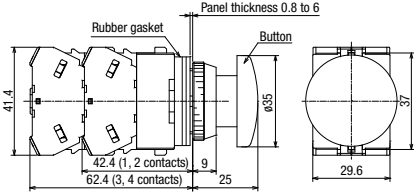
Mushroom / Pushlock Turn Reset

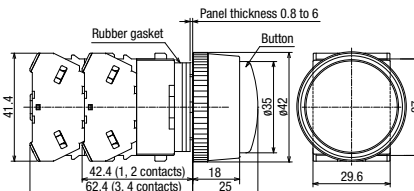
Package Quantity: 1

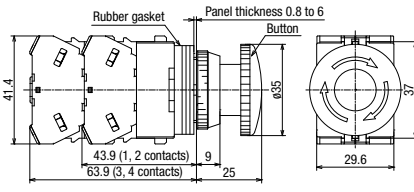
Shape	Operation	Contact	Part No.	Color Code	Dimensions (mm)
Mushroom ABS3 AOS3 	Momentary	1NO	ABS310N*	B G R Y S W	 <p>Note: The depth behind the panel of maintained unit is 1.5 mm longer than the momentary unit.</p>
		1NC	ABS301N*		
		1NO-1NC	ABS311N*		
		2NO	ABS320N*		
		2NC	ABS302N*		
		2NO-2NC	ABS322N*		
	Maintained	1NO	AOS310N*		
		1NC	AOS301N*		
		1NO-1NC	AOS311N*		
		2NO	AOS320N*		
Mushroom with Full Shroud ABGS3 AOGS3 	Momentary	1NO	ABGS310N*	B G R Y S W	
		1NC	ABGS301N*		
		1NO-1NC	ABGS311N*		
		2NO	ABGS320N*		
		2NC	ABGS302N*		
		2NO-2NC	ABGS322N*		
Pushlock Turn Reset (*1) AVS3 		1NO	AVS310N*	R Y	
		1NC	AVS301N*		
		1NO-1NC	AVS311N*		
		2NO	AVS320N*		
		2NC	AVS302N*		
		2NO-2NC	AVS322N*		

- Specify a color code in place of * in Part No. B (black), G (green), Y (yellow), S (blue), W (white)
- Round bezel (metal): Chrome-plated
- Pushbuttons with 1 or 3 contact blocks have a dummy block.
- See page 4 for other contact configurations and gold-plated silver contacts.
- Pushbuttons: terminal screws M3.5, integrated terminal cover
- See page 9 for bottom view.

*1) Pushlock turn reset pushbuttons cannot be used as emergency stop switches. When emergency stop switches are required, use HW series emergency stop switches and ring adapter (HW9Z-A25).



Pushbutton operation

Pushlock Turn Reset

Pushlock turn reset is locked when pressed, and reset when turned clockwise.

Mushroom Push-Pull / Square Flush

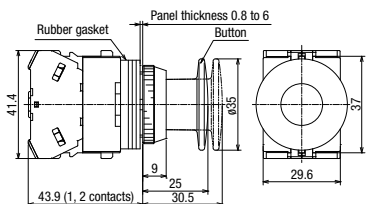
Package Quantity: 1

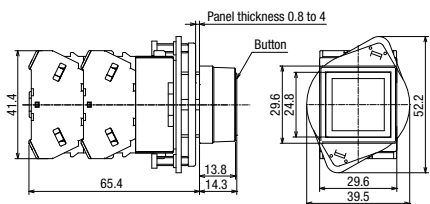
Shape	Operation	Contact	Part No.	Color Code	Dimensions (mm)
Mushroom Push-Pull (*1) AYS31 		1NO	AYS3110N*	B G R Y	
		1NC	AYS3101N*		
		1NO-1NC	AYS3111N*		
		2NO	AYS3120N*		
		2NC	AYS3102N*		
Square Flush UBQS1 UOQS1 	Momentary	1NO	UBQS110N*	B G R Y S	
		1NC	UBQS101N*		
		1NO-1NC	UBQS111N*		
		2NO	UBQS120N*		
		2NC	UBQS102N*		
		2NO-2NC	UBQS122N*		
	Maintained	1NO	UOQS110N*		
		1NC	UOQS101N*		
		1NO-1NC	UOQS111N*		
		2NO	UOQS120N*		
		2NC	UOQS102N*		
		2NO-2NC	UOQS122N*		











- Specify a color code in place of * in Part No. B (black), G (green), Y (yellow), S (blue).
 - Round bezel (metal): Chrome-plated
 - Square bezel (plastic): Black
 - Pushbuttons with 1 or 3 contact blocks have a dummy block.
 - See page 4 for other contact configurations and gold-plated silver contacts.
 - Push-pull switch can have a maximum of two contact blocks.
 - Pushbuttons: terminal screws M3.5, integrated terminal cover
- *1) Push-pull switch with red button cannot be used as emergency stop switches.
 When emergency stop switches are required, use HW series emergency stop switches and ring adapter (HW9Z-A25).

Pushbutton operation

Push-Pull

2-position switches with button maintained in both depressed and reset positions.

Push-Pull contact operation

Contact	AYW4	
	Push	Pull
1NO		
1NC		
1NO-1NC		
2NO		
2NC		

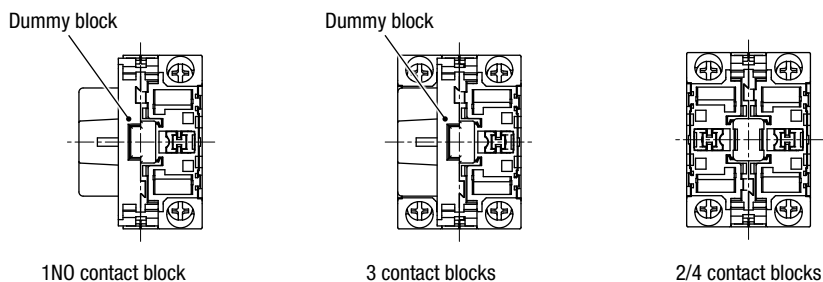

Bottom View (non-illuminated switches)



- For 1NC contact, the contact block will mount on the opposite side.
- See page 33 for wiring.
- Integrated terminal cover

Dome / Square / Rectangular (Marking) Pilot Lights

Package Quantity: 1

Shape	Illumination	Rated Voltage	Part No.	Color Code
Dome APS1  (24V AC/DC)  With transformer (100/110V AC)	LED	24V AC/DC	APS122DN*	R G Y A S PW
		100/110V AC	APS116DN*	
		200/220V AC	APS126DN*	
Square (Marking) UPQS1B (Plastic Bezel)  (24V AC/DC)  With transformer (100/110V AC)	LED	24V AC/DC	UPQS1B22DN*	R G Y A S PW
		100/110V AC	UPQS1B16DN*	
		200/220V AC	UPQS1B26DN*	

- Specify a color code in place of * in Part No. R (red), G (green), Y (yellow), A (amber), S (blue), PW (pure white)
- An LED lamp is installed in pilot lights unless otherwise specified.
- A pure white (PW) LED lamp is used for yellow (Y) illumination.
- A (pure white (PW) lens of marking type consists of a clear lens and a white marking plate.
- See page 30 for marking plate size and engraving area.
- Round bezel (metal): Chrome-plated
- Square bezel (plastic): Black
- See page 4 for other operating voltage such as 6V AC/DC, 12V AC/DC, and 110V DC.
- See page 4 for how to specify units without LED lamps. When using a commercially available lamp, choose a lamp with rated voltage 5 to 30V AC/DC and 1W maximum, and with the same base and shape. The operation of pilot lights cannot be guaranteed when a commercially available lamp is used.

Dimensions

All dimensions in mm

Round Flush

Terminal screws: M3.5

6, 12, 24V AC/DC, Without LED lamp

100/110V AC, 200/220V AC (240V AC maximum)

110V DC, 380V AC minimum

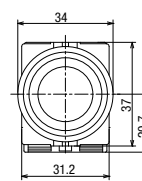
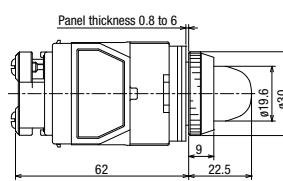
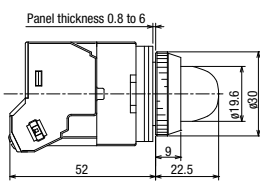
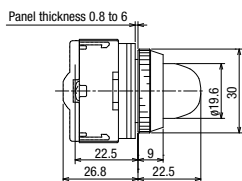

Square Flush (Marking Type)

Terminal screws: M3.5

APQW1B

6, 12, 24V AC/DC, Without LED lamp

100/110V AC, 200/220V AC (240V AC maximum)

110V DC, 380V AC minimum

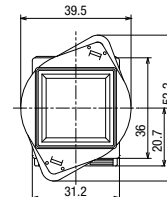
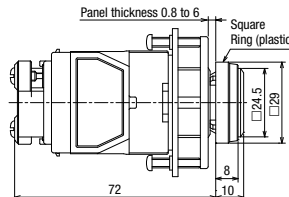
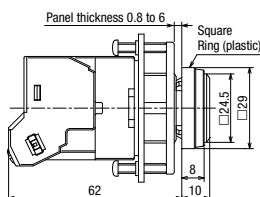
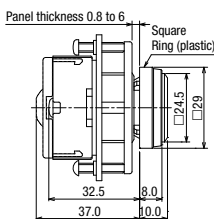

Bottom View

6, 12, 24V AC/DC, Without LED lamp

100/110V AC, 200/220V AC (240V AC maximum)

110V DC, 380V AC minimum

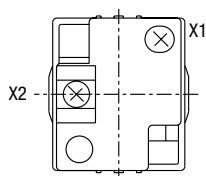

With terminal cover (APS-PVL)
(APS-PVL is supplied with full voltage type)

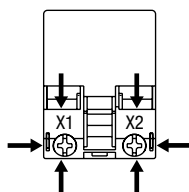

Integrated terminal cover

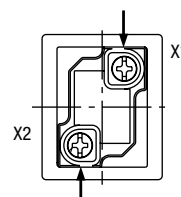

For DC-DC Converter types,
terminal X1 is ⊕, X2 is ⊖.
Integrated terminal cover

• See page 33 for wiring.

Extended / Extended with Full Shroud



Package Quantity: 1

Shape	Illumination	Operation	Rated Voltage	Contact Configuration	Part No.	Color Code
Round Extended ALS2 AOLS2  (24V AC/DC)  With transformer (100/110V AC)	LED	Momentary	24V AC/DC	1NO-1NC	ALS22211DN*	R G Y A S PW
				2NO	ALS22220DN*	
			100/110V AC	2NO-2NC	ALS22222DN*	
				1NO-1NC	ALS21611DN*	
			2NO	ALS21620DN*		
			2NO-2NC	ALS21622DN*		
		200/220V AC	1NO-1NC	ALS22611DN*		
			2NO	ALS22620DN*		
		Maintained	24V AC/DC	1NO-1NC	AOLS22211DN*	
				2NO	AOLS22220DN*	
			100/110V AC	2NO-2NC	AOLS22222DN*	
				1NO-1NC	AOLS21611DN*	
2NO	AOLS21620DN*					
2NO-2NC	AOLS21622DN*					
200/220V AC	1NO-1NC	AOLS22611DN*				
	2NO	AOLS22620DN*				
Round Extended with Full Shroud ALFS2 AOLFS2  (24V AC/DC)  With transformer (100/110V AC)	LED	Momentary	24V AC/DC	1NO-1NC	ALFS22211DN*	R G Y A S PW
				2NO	ALFS22220DN*	
			100/110V AC	2NO-2NC	ALFS22222DN*	
				1NO-1NC	ALFS21611DN*	
			2NO	ALFS21620DN*		
			2NO-2NC	ALFS21622DN*		
		200/220V AC	1NO-1NC	ALFS22611DN*		
			2NO	ALFS22620DN*		
		Maintained	24V AC/DC	2NO-2NC	ALFS22622DN*	
				1NO-1NC	AOLFS22211DN*	
			100/110V AC	2NO	AOLFS22220DN*	
				2NO-2NC	AOLFS22222DN*	
200/220V AC	1NO-1NC		AOLFS21611DN*			
	2NO		AOLFS21620DN*			
2NO-2NC	AOLFS21622DN*					
200/220V AC	1NO-1NC	AOLFS22611DN*				
	2NO	AOLFS22620DN*				
2NO-2NC	AOLFS22622DN*					

- Specify a color code in place of * in Part No. R (red), G (green), Y (yellow), A (amber), S (blue), PW (pure white)
- An LED lamp is installed in illuminated pushbuttons unless otherwise specified.
- Round bezel (metal): Chrome-plated
- A pure white (PW) LED lamp is used for yellow (Y) illumination.
- See page 6 for other operating voltage such as 6V AC/DC, 12V AC/DC, and 110V DC.
- See page 6 for other contact configurations and gold-plated silver contacts.
- Illuminated pushbuttons of 24V AC/DC or below with 2 or 4 contact blocks have a dummy block.
- See page 6 for how to specify units without LED lamps. When using a commercially available lamp, choose a lamp with rated voltage 5 to 30V AC/DC and 1W maximum, and with the same base and shape. The operation of pilot lights cannot be guaranteed when a commercially available lamp is used.

Mushroom Pushlock Turn Reset

Package Quantity: 1



Shape	Illumination	Rated Voltage	Contact Configuration	Part No.	Color Code
Mushroom Pushlock Turn Reset AVLS3 (*1)  (24V AC/DC)  With transformer (100/110V AC)	LED	24V AC/DC	1NO-1NC	AVLS32211DNR	R
			2NO	AVLS32220DNR	
			2NO-2NC	AVLS32222DNR	
		100/110V AC	1NO-1NC	AVLS31611DNR	
			2NO	AVLS31620DNR	
			2NO-2NC	AVLS31622DNR	
		200/220V AC	1NO-1NC	AVLS32611DNR	
			2NO	AVLS32620DNR	
			2NO-2NC	AVLS32622DNR	

- An LED lamp is installed in illuminated pushbuttons unless otherwise specified. Round bezel (metal): Chrome-plated
- See page 6 for other operating voltage such as 6V AC/DC, 12V AC/DC, and 110V DC.
- See page 6 for other contact configurations and gold-plated silver contacts.
- Illuminated pushbuttons of 24V AC/DC or below with 2 or 4 contact blocks have a dummy block.

- *1) Pushlock turn reset switch cannot be used as emergency stop switches. When emergency stop switches are required, use XW or HW series pushbuttons (ISO 13850 and IEC 60947-5-5 compliant).
- See page 6 for how to specify units without LED lamps. When using a commercially available lamp, choose a lamp with rated voltage 5 to 30V AC/DC and 1W maximum, and with the same base and shape. The operation of pilot lights cannot be guaranteed when a commercially available lamp is used.

Square Flush

Package Quantity: 1

Shape	Illumination	Operation	Rated Voltage	Contact Configuration	Part No.	Color Code
Square Flush (Marking) ULQS1B UOLS1B  (24V AC/DC)  With transformer (100/110V AC)	LED	Momentary	24V AC/DC	1NO-1NC	ULQS1B2211DN*	R G Y A S PW
				2NO	ULQS1B2220DN*	
				2NO-2NC	ULQS1B2222DN*	
			100/110V AC	1NO-1NC	ULQS1B1611DN*	
				2NO	ULQS1B1620DN*	
				2NO-2NC	ULQS1B1622DN*	
			200/220V AC	1NO-1NC	ULQS1B2611DN*	
				2NO	ULQS1B2620DN*	
				2NO-2NC	ULQS1B2622DN*	
		Maintained	24V AC/DC	1NO-1NC	UOLS1B2211DN*	R G Y A S PW
				2NO	UOLS1B2220DN*	
				2NO-2NC	UOLS1B2222DN*	
			100/110V AC	1NO-1NC	UOLS1B1611DN*	
				2NO	UOLS1B1620DN*	
				2NO-2NC	UOLS1B1622DN*	
			200/220V AC	1NO-1NC	UOLS1B2611DN*	
				2NO	UOLS1B2620DN*	
				2NO-2NC	UOLS1B2622DN*	

- Specify a color code in place of * in Part No. R (red), G (green), Y (yellow), A (amber), S (blue), PW (pure white) An LED lamp is installed in illuminated pushbuttons unless otherwise specified.
- A pure white (PW) LED lamp is used for yellow (Y) illumination.
- Square bezel (plastic): Black
- Marking plate size: 21.2 × 1.0 mm (two plates are supplied)
- The PW (pure white) lens of marking type consists of a clear lens and a white marking plate.
- See page 33 for marking plate size and engraving area.
- See page 6 for other operating voltage such as 6V AC/DC, 12V AC/DC, and 110V DC.

- See page 6 for other contact configurations and gold-plated silver contacts.
- Illuminated pushbuttons of 24V AC/DC or below with 2 or 4 contact blocks have a dummy block.
- See page 6 for how to specify units without LED lamps. When using a commercially available lamp, choose a lamp with rated voltage 5 to 30V AC/DC and 1W maximum, and with the same base and shape. The operation of pilot lights cannot be guaranteed when a commercially available lamp is used.

Dimensions

All dimensions in mm

Round Extended (momentary/maintained)

Terminal screw: M3.5, Integrated terminal cover

6, 12, 24V AC/DC, Without LED lamp

100/110V, 200/220V AC (240V AC maximum)

110V DC, 380V AC minimum

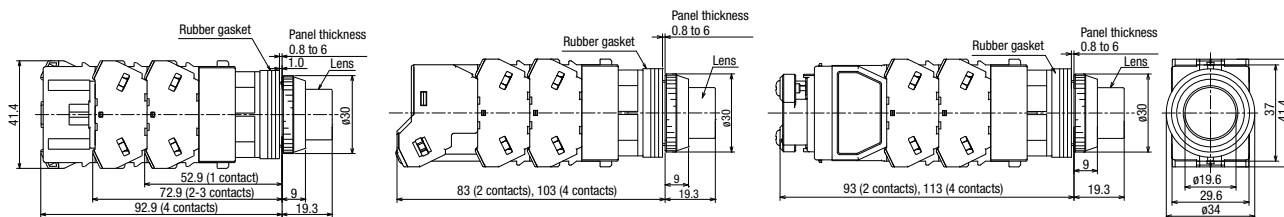

Round Extended with Full Shroud (momentary/maintained)

Terminal screw: M3.5, Integrated terminal cover

6, 12, 24V AC/DC, Without LED lamp

100/110V, 200/220V AC (240V AC maximum)

110V DC, 380V AC minimum

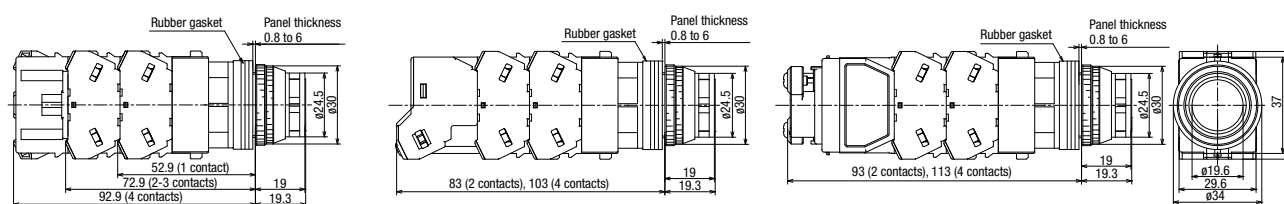

Mushroom Pushlock Turn Reset

Terminal screw: M3.5, Integrated terminal cover

6, 12, 24V AC/DC, Without LED lamp

100/110V, 200/220V AC (240V AC maximum)

110V DC, 380V AC minimum

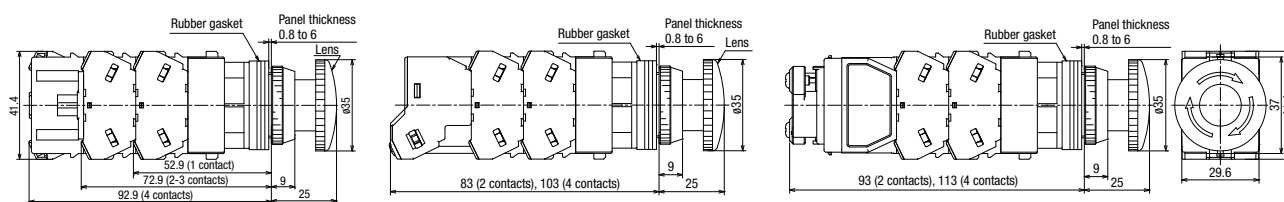

Square Flush

Terminal screw: M3.5, Integrated terminal cover

6, 12, 24V AC/DC, Without LED lamp

100/110V, 200/220V AC (240V AC maximum)

110V DC, 380V AC minimum

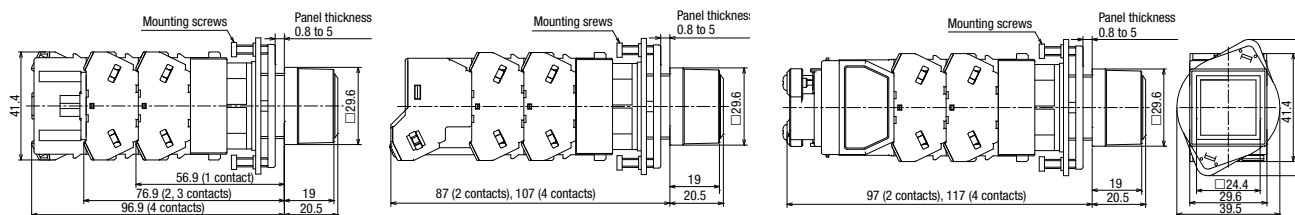

Bottom View (illuminated units)

6, 12, 24V AC/DC, Without LED lamp

100/110V, 200/220V AC (240V AC maximum)

110V DC, 380V AC minimum

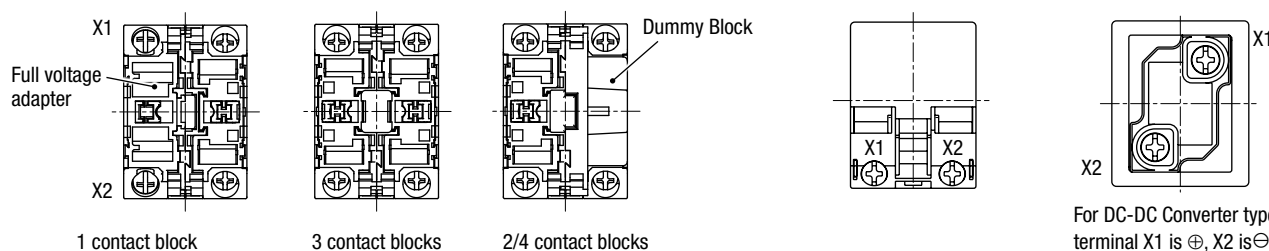

• See page 33 for wiring.

Selector Switches (Knob Operator)

Package Quantity: 1

Shape	Knob Operator ASS												
	Contact Code	Contact Block		Operator Position			Maintained 1 2	Spring Return from Right 1 2	Spring Return from Left				
		Mounting Position	Contact	1	2	Mounting Position			Contact	1	2	1 2	
90° 2-position	1NO (10)	①	NO		●		ASS210N	ASS2110N	①	NO	●		ASS2210N
		②	—	Dummy Block					②	—	—		
	1NO-1NC (11)	①	NO		●		ASS211N	ASS2111N	①	NO	●		ASS2211N
		②	NC	●		●			②	NC		●	
	2NO (20)	①	NO		●		ASS220N	ASS2120N	①	NO	●		ASS2220N
		②	NO		●				②	NO	●		
	2NO-2NC (22)	①	NO		●		ASS222N	ASS2122N	①	NO	●		ASS2222N
		②	NC	●		●			②	NC		●	
		③	NO	●		●			③	NO	●		
	2R ☆	①	EM	■			ASS22RN-118 ☆	ASS212RN-118 ☆	①				—
		②	LB	■					②				
	2R ☆	①					—	—	①	LB	■		ASS222RN-169 ☆
②						②			EM	■			
45° 3-position	2NO (20)	①	NO	●			ASS320N	ASS3120N	ASS3220N			ASS3320N	
		②	NO			●							
	2NC (02)	①	NC		■		ASS302N	ASS3102N	ASS3202N			ASS3302N	
		②	NC	■									
	2NO-2NC (22)	①	NO	●			ASS322N	ASS3122N	ASS3222N			ASS3322N	
		②	NO			●							
		③	NC		■								
	4NO (40)	①	NO	●			ASS340N	ASS3140N	ASS3240N			ASS3340N	
		②	NO			●							
		③	NO	●									
		④	NO			●							
	4NC (04)	①	NC		■		ASS304N	ASS3104N	ASS3204N			ASS3304N	
		②	NC	■									
		③	NC		■								
		④	NC	■									
3S ☆	①	NO	●			ASS33SN-243 ☆	—	—			—		
	②	NO			●								
	③	NC		●									
	④	—	Dummy Block										

- Knob operator: white indicator on black body
- Round bezel (metal): Chrome-plated
- See page 19 to 21 for other contact arrangements.
- Selector switches with one or three contact blocks contain a dummy block.
- Spring return is not available with contact code 3S.

- On the contact arrangement marked with ☆ in the table above, the rated current (load switching current) is reduced to a half of the related current of the contact block. The rated insulation voltage and the rated thermal current remain unchanged.
- See page 5 for gold-plated silver contacts.
- Turn the operator to each position accurately.

Contact Block Mounting Position

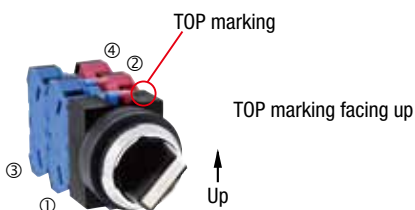

Dimensions

All dimensions in mm.

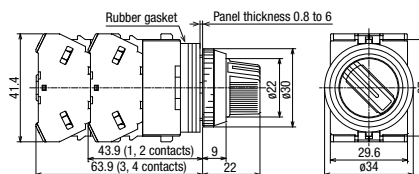

Terminal screws: M3.5
Integrated cover

• See page 14 for bottom view.

Selector Switches (Lever Operator)

Package Quantity: 1

Shape	Lever Operator ASS□L												
	Contact Code	Contact Block		Operator Position			Maintained	Spring Return from Right	Spring Return from Left				
		Mounting Position	Contact	1	2		1 2	1 2	Contact Block		Operator Position		1 2
							Mounting Position	Contact	1	2	1	2	
90° 2-position	1NO (10)	①	NO		●		ASS2L10N	ASS21L10N	①	NO	●		ASS22L10N
		②	—	Dummy Block						②	—	—	
	1NO-1NC (11)	①	NO		●		ASS2L11N	ASS21L11N	①	NO	●		ASS22L11N
		②	NC	●					②	NC		●	
	2NO (20)	①	NO			●	ASS2L20N	ASS21L20N	①	NO	●		ASS22L20N
		②	NO			●			②	NO	●		
	2NO-2NC (22)	①	NO			●	ASS2L22N	ASS21L22N	①	NO	●		ASS22L22N
		②	NC	●					②	NC		●	
		③	NO			●			③	NO	●		
	2R ☆	①	EM	—			ASS2L2RN-118 ☆	ASS21L2RN-118 ☆	①				—
②		LB	—			②							
2R ☆	①					—	—	①	LB	—		ASS22L2RN-169 ☆	
	②							②	EM	—			
45° 3-position	2NO (20)	①	NO	●			ASS3L20N	ASS31L20N	ASS32L20N		ASS33L20N		
		②	NO			●							
	2NC (02)	①	NC	—			ASS3L02N	ASS31L02N	ASS32L02N		ASS33L02N		
		②	NC	—									
	2NO-2NC (22)	①	NO	●			ASS3L22N	ASS31L22N	ASS32L22N		ASS33L22N		
		②	NO			●							
		③	NC	—									
	4NO (40)	①	NO	●			ASS3L40N	ASS31L40N	ASS32L40N		ASS33L40N		
		②	NO			●							
		③	NO	●									
		④	NO			●							
	4NC (04)	①	NC	—			ASS3L04N	ASS31L04N	ASS32L04N		ASS33L04N		
		②	NC	—									
		③	NC	—									
④		NC	—										
3S ☆	①	NO	●			ASS3L3SN-243 ☆	—	—		—			
	②	NO			●								
	③	NC			●								
	④	—	Dummy Block										

- Knob operator: white indicator on black body
- Round bezel (metal): Chrome-plated
- See page 19 to 21 for other contact arrangements.
- Selector switches with one or three contact blocks contain a dummy block.
- Spring return is not available with contact code 3S.

- On the contact arrangement marked with ☆ in the table above, the rated current (load switching current) is reduced to a half of the related current of the contact block. The rated insulation voltage and the rated thermal current remain unchanged.
- See page 5 for gold-plated silver contacts.
- Turn the operator to each position accurately.

Contact Block Mounting Position

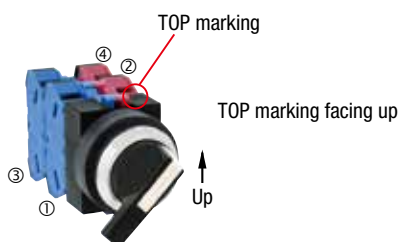

Dimensions

All dimensions in mm.

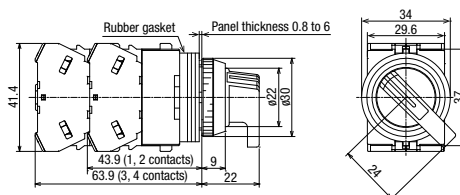

Terminal screw: M3.5
Integrated terminal cover

• See page 14 for bottom view.

Key Selector Switches

Package Quantity: 1

Shape	Key Selector Switch ASS□K (Key No. 0)														
	Contact Code	Contact Block		Operator Position			Maintained 1 2	Spring Return from Right 1 2	Spring Return from Left						
		Mounting Position	Contact	1	2				Mounting Position	Contact	1	2	1 2		
90° 2-position	1NO (10)	①	NO		●		ASS2K10N	ASS21K10N	①	NO	●		ASS22K10N		
		②	—	Dummy Block					②	—	—				
	1NO-1NC (11)	①	NO		●		ASS2K11N	ASS21K11N	①	NO	●		ASS22K11N		
		②	NC	●					②	NC		●			
	2NO (20)	①	NO		●		ASS2K20N	ASS21K20N	①	NO	●		ASS22K20N		
		②	NO		●				②	NO	●				
	2NO-2NC (22)	①	NO		●		ASS2K22N	ASS21K22N	①	NO	●		ASS22K22N		
		②	NC	●					②	NC		●			
		③	NO		●				③	NO	●				
		④	NC	●					④	NC		●			
2R ☆	①	EM	—			ASS2K2RN-118	ASS21K2RN-118	①				—			
	②	LB	—					②							
2R ☆	①					—	—	①	LB	—		ASS22K2RN-169 ☆			
	②							②	EM	—					
45° 3-position	2NO (20)	①	NO	●			ASS3K20N	ASS31K20N	Spring Return from Left 1 0 2				ASS32K20N	ASS33K20N	
		②	NO			●			②						●
	2NC (02)	①	NC			—	ASS3K02N	ASS31K02N	Spring Return from Left 1 0 2				ASS32K02N	ASS33K02N	
		②	NC			—			②						—
	2NO-2NC (22)	①	NO	●			ASS3K22N	ASS31K22N	Spring Return from Left 1 0 2				ASS32K22N	ASS33K22N	
		②	NO			●			②						●
		③	NC			—			③						—
	4NO (40)	①	NO	●			ASS3K40N	ASS31K40N	Spring Return from Left 1 0 2				ASS32K40N	ASS33K40N	
		②	NO			●			②						●
		③	NO	●					③						●
		④	NO			●			④						●
	4NC (04)	①	NC			—	ASS3K04N	ASS31K04N	Spring Return from Left 1 0 2				ASS32K04N	ASS33K04N	
		②	NC			—			②						—
		③	NC			—			③						—
④		NC			—	④						—			
3S ☆	①	NO	●			ASS3K3SN-243 ☆	—	Spring Return from Left 1 0 2				—	—		
	②	NO			●			②						●	
	③	NC						③							
	④	—	Dummy Block					④							

- Cylinder cover: black
- Round bezel (metal): Chrome-plated
- See page 19 to 21 for other contact arrangements.
- Selector switches with one or three contact blocks contain a dummy block.
- Spring return is not available with contact code 3S.
- On the contact arrangement marked with ☆ in the table above, the rated current (load switching current) is reduced to a half of the related current of the contact block. The rated insulation voltage and the rated thermal current remain unchanged.

- On the spring-returned types, the key can be released only from the maintained position. On the maintained types, the key can be released from every position. Other key retained positions are also available. See page 7.
- See page 5 for gold-plated silver contacts.
- Key selector switch is supplied with two standard keys.
- Different key number is available upon request. Contact IDEC. Turn the key to each position accurately.

Contact Block Mounting Position

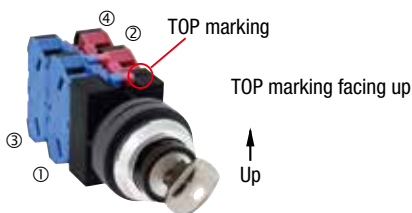

Dimensions

All dimensions in mm.

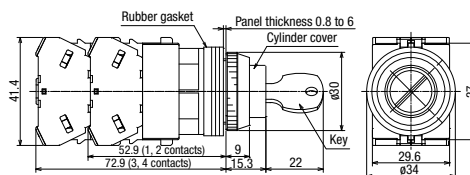

Terminal screw: M3.5
Integrated terminal cover

• See page 14 for bottom view.

LED

Illuminated Selector Switches

Package Quantity: 1

Shape	ASLS												
	Contact Code	Contact Block		Operator Positions		Rated Voltage	Maintained	Spring return from right	Spring return from left		Color Code		
		Mounting Position	Contact	1	2		1 2	1 2	Mounting Position	Contact		1 2	
90° 2-position	1NO-1NC (11)	①	NO		●	24V AC/DC	ASLS22211DN*	ASLS212211DN*	①	NO	●	ASLS222211DN*	
		②	NC	●		100/110V AC	ASLS21611DN*	ASLS211611DN*	②	NC		●	ASLS2221611DN*
						200/220V AC	ASLS22611DN*	ASLS212611DN*					ASLS2222611DN*
	2NO (20)	①	NO		●	24V AC/DC	ASLS22220DN*	ASLS212220DN*	①	NO	●		ASLS222220DN*
		②	NO		●	100/110V AC	ASLS21620DN*	ASLS211620DN*	②	NO	●		ASLS2221620DN*
						200/220V AC	ASLS22620DN*	ASLS212620DN*					ASLS2222620DN*
	2NO-2NC (22)	①	NO		●	24V AC/DC	ASLS22222DN*	ASLS212222DN*	①	NO	●		ASLS222222DN*
		②	NC	●		100/110V AC	ASLS21622DN*	ASLS211622DN*	②	NC		●	ASLS2221622DN*
		③	NO		●	200/220V AC	ASLS22622DN*	ASLS212622DN*	③	NO	●		ASLS2222622DN*
		④	NC	●					④	NC		●	
	45° 3-position	2NO (20)	①	NO	●		24V AC/DC	ASLS32220DN*	ASLS312220DN*	ASLS322220DN*			ASLS332220DN*
			②	NO		●	100/110V AC	ASLS31620DN*	ASLS311620DN*	ASLS31620DN*			ASLS331620DN*
						200/220V AC	ASLS32620DN*	ASLS312620DN*	ASLS322620DN*			ASLS332620DN*	
2NC (02)		①	NC		●	24V AC/DC	ASLS32202DN*	ASLS312202DN*	ASLS32202DN*			ASLS332202DN*	
		②	NC		●	100/110V AC	ASLS31602DN*	ASLS311602DN*	ASLS31602DN*			ASLS331602DN*	
						200/220V AC	ASLS32602DN*	ASLS312602DN*	ASLS322602DN*			ASLS332602DN*	
2NO-2NC (22)		①	NO		●	24V AC/DC	ASLS32222DN*	ASLS312222DN*	ASLS32222DN*			ASLS332222DN*	
		②	NO		●	100/110V AC	ASLS31622DN*	ASLS311622DN*	ASLS31622DN*			ASLS331622DN*	
		③	NC		●	200/220V AC	ASLS32622DN*	ASLS312622DN*	ASLS322622DN*			ASLS332622DN*	
		④	NC		●								
4NO (40)		①	NO		●	24V AC/DC	ASLS32240DN*	ASLS312240DN*	ASLS32240DN*			ASLS332240DN*	
		②	NO		●	100/110V AC	ASLS31640DN*	ASLS311640DN*	ASLS31640DN*			ASLS331640DN*	
		③	NO		●	200/220V AC	ASLS32640DN*	ASLS312640DN*	ASLS322640DN*			ASLS332640DN*	
		④	NO		●								
4NC (04)		①	NC		●	24V AC/DC	ASLS32204DN*	ASLS312204DN*	ASLS32204DN*			ASLS332204DN*	
		②	NC		●	100/110V AC	ASLS31604DN*	ASLS311604DN*	ASLS31604DN*			ASLS331604DN*	
		③	NC		●	200/220V AC	ASLS32604DN*	ASLS312604DN*	ASLS322604DN*			ASLS332604DN*	
		④	NC		●								

- Specify a color code in place of * in Part No. R (red), G (green), Y (yellow), A (amber), S (blue), PW (pure white)
- An LED lamp is installed in illuminated selector switches unless otherwise specified.
- A pure white (PW) LED lamp is used for yellow (Y) illumination.
- Round bezel (metal): Chrome-plated
- See page 19 to 21 for other contact arrangements.
- See page 6 for other operating voltage such as 110V DC.
- See page 6 for gold-plated silver contacts.
- Illuminated selector switches of 24V AC/DC or below with 2 or 4 contact blocks have a dummy block.
- See page 6 for how to specify units without LED lamps. When using a commercially available lamp, choose a lamp with rated voltage 5 to 30V AC/DC and 1W maximum, and with the same base and shape. The operation of pilot lights cannot be guaranteed when a commercially available lamp is used.

Contact Block Mounting Position

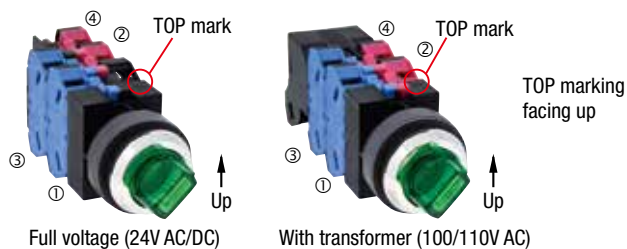

Terminal screw: M3.5
Integrated terminal cover • See page 14 for bottom view.

Dimensions

All dimensions in mm.

24V AC/DC, Without LED lamp

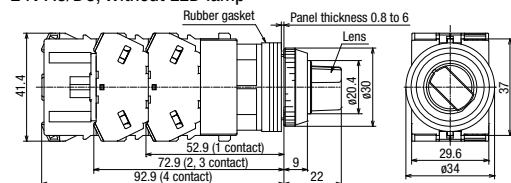

100/110V AC, 200/220V AC (240V AC or below)

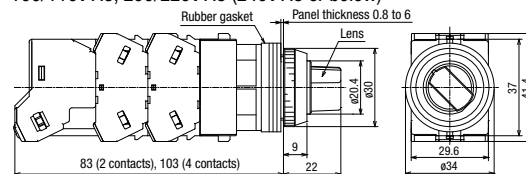

110V DC, 380V AC minimum

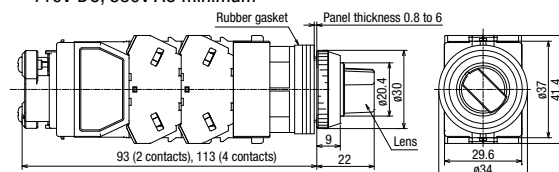

Selector Switch Contact Arrangement

90° 2-position (maintained/spring return from right/spring return from left)

Contact Code	Circuit No.	Contact Block		Operator Operation and Circuit Availability									Operator Availability						
				Maintained			Spring return from right			Spring return from left									
		Mounting Position	Contact	Knob/Lever	Key	Illuminated	Knob/Lever	Key	Illuminated	Knob/Lever	Key	Illuminated	Knob	Lever	Key	Illuminated			
				Operator Position		Operator Position		Operator Position		24V AC/DC		100/110V AC, 200/220V AC							
				1	2	1	2	1	2	R, G, Y, A	S, PW	R, G, Y, A				S, PW			
10	—	①	NO		●				●			×	×	×	×	×	—	—	
		②	—	Dummy Block			Dummy Block			Dummy Block			×	×	×	×	×	—	—
01	—	①	NC	●				●			●	×	×	×	×	×	—	—	
		②	—	Dummy Block			Dummy Block			Dummy Block			×	×	×	×	×	—	—
11	—	①	NO		●				●			×	×	×	×	×	×	×	
		②	NC	●			●			●		×	×	×	×	×	×	×	
20	—	①	NO		●				●			×	×	×	×	×	×	×	
		②	NO		●				●			×	×	×	×	×	×	×	
02	—	①	NC	●			●			●	×	×	×	×	×	×	×	×	
		②	NC	●			●			●	×	×	×	×	×	×	×	×	
22	—	①	NO		●				●			×	×	×	×	×	×	×	
		②	NC	●			●			●	×	×	×	×	×	×	×	×	
		③	NO		●				●			×	×	×	×	×	×	×	
		④	NC	●			●			●	×	×	×	×	×	×	×	×	
31	107	①	NC	●			●			●	×	×	×	×	×	×	×	×	
		②	NO		●			●			×	×	×	×	×	×	×	×	
		③	NO		●			●			×	×	×	×	×	×	×	×	
		④	NO		●			●			×	×	×	×	×	×	×	×	
40	—	①	NO		●				●		×	×	×	×	×	×	×	×	
		②	NO		●				●		×	×	×	×	×	×	×	×	
		③	NO		●				●		×	×	×	×	×	×	×	×	
		④	NO		●				●		×	×	×	×	×	×	×	×	
2R ☆	118 ☆	①	EM	—————			—————						×	×	×	×	×	×	
		②	LB	—————			—————						×	×	×	×	×	×	
	168 ☆	①	EM							—————			×	×	×	×	×	×	
		②	LB							—————			×	×	×	×	×	×	

• On the contact arrangement marked with ☆ in the table above (contact code: 2R), the rated current (load switching current) is reduced to a half of the related current of the contact block. The rated insulation voltage and the rated thermal current remain unchanged.

Contact Block Mounting Position

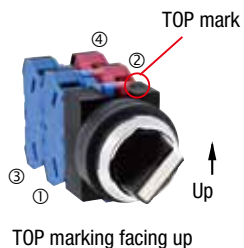

Ordering Information

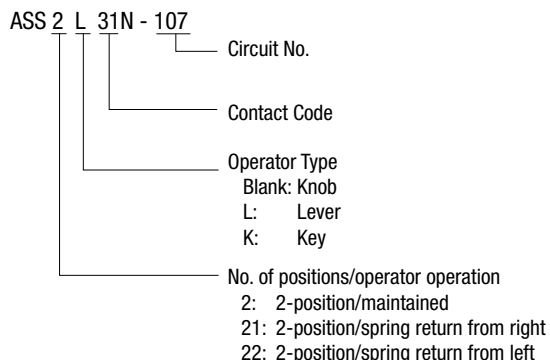

45° 3-position <Maintained / Spring Return from Right / Spring Return from Left / Spring Return Two-way>

Contact Code	Circuit No.	Contact Block		Operator Position			Circuit Availability			Operator Availability								
		Mounting Position	Contact	1	0	2	Kob/ Lever	Key	Illuminated	Knob	Lever	Key	Illuminated					
				●	●	●							24V AC/DC		100/110V AC, 200/220V AC			
													R, G, Y, A	S, PW	R, G, Y, A	S, PW		
11	202	①	NO	●														
		②	NC		■				×	×	×	×	×	×	×	×	×	×
	203	①	NC			■												
		②	NO				●			×	×	×	×	×	×	×	×	×
	303	①	NC			●												
		②	NO					●		×	×	×	×	×	×	×	×	×
20	—	①	NO	●														
		②	NO						×	×	×	×	×	×	×	×	×	
02	—	①	NC			■												
		②	NC		■				×	×	×	×	×	×	×	×	×	
22	—	①	NO	●														
		②	NO															
		③	NC			■				×	×	×	×	×	×	×	×	
		④	NC		■													
	210	①	NC			■												
		②	NO				●			×	×	×	×	×	×	×	×	
		③	NC			■												
		④	NO					●										
	310	①	NC			●												
		②	NO							×	×	×	×	×	×	×	×	
		③	NC			●												
		④	NO															
40	—	①	NO	●														
		②	NO															
		③	NO		●					×	×	×	×	×	×	×	×	
		④	NO															
04	—	①	NC			■												
		②	NC		■													
		③	NC			■				×	×	×	×	×	×	×	×	
		④	NC		■													

Contact Block Mounting Position

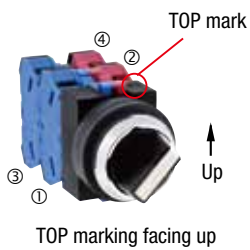

Ordering Information

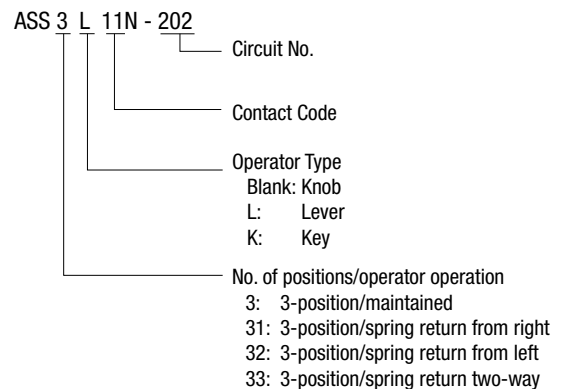

45° 3-position (Maintained)

Contact Code	Circuit No.	Contact Block		Operator Position			Circuit Availability			Operator Availability						
		Mounting Position	Contact	1	0	2	Kob/ Lever	Key	Illuminated	Knob	Lever	Key	Illuminated			
				R, G, Y, A	S, PW	100/110V AC, 200/220V AC										
						R, G, Y, A							S, PW			
3S ☆	243	①	NO	●			×			×	×	×	×	×	—	—
		②	NO			●										
		③	NC		●											
		④	—	Dummy Block												
4S ☆	237	①	NO	●			×			×	×	×	×	×	×	×
		②	NO			●										
		③	NC		●											
		④	NO			●										
	1336	①	NO	●			×			×	×	—	×	×	×	×
		②	NO			●										
		③	NC		●											
		④	NC		●											

Ordering Information

ASS 3 L 3SN - 243
 Circuit No.
 Contact Code
 Operator Type
 Blank: Knob
 L: Lever
 K: Key
 No. of positions/operator operation
 3: 3-position/maintained

45° 4-position (Maintained)

Contact Code	Circuit No.	Contact Block		Operator Position				Operator Availability	
				Maintained					
				Operator Position					
		Mounting Position	Contact	1	2	3	4	Knob	Lever
4S ☆	407	①	LB	—————				×	×
		②	NC		●				
		③	NC			●			
		④	NO				●		
	411	①	NO	●				×	×
		②	NC		●				
		③	NC			●			
		④	NO				●		

Ordering Information

ASS 4 L 4SN - 411
 Circuit No.
 Contact Code
 Operator Type
 Blank: Knob
 L: Lever
 No. of positions/operator operation
 4: 4-position/maintained
 5: 5-position/maintained

30° 5-position (Maintained)

Contact Code	Circuit No.	Contact Block		Operator Position					Operator Availability (*1)	
				Maintained						
				Operator Position						
		Mounting Position	Contact	1	2	3	4	5	Knob	Lever
4S ☆	501	①	NO	●	●				×	×
		②	NC		●					
		③	NC				●			
		④	NO					●		

- On the contact arrangement marked with ☆ in the table above (contact code: 3S, 4S), the rated current (load switching current) is reduced to a half of the related current of the contact block. The rated insulation voltage and the rated thermal current remain unchanged.
- For models with ☆, contacts may overlap when the operator position is changed.

Contact Block Mounting Position

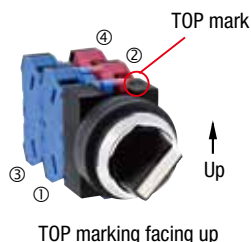

Nameplates		All dimensions in mm.			
Shape	Legend	Material	Part No.	Ordering No.	Package Quantity
	<div style="display: flex; justify-content: space-between;"> <div style="width: 25%;"> <p>NSA</p> <p>1.2 mm thick</p> </div> <div style="width: 25%;"> <p>Blank</p> </div> <div style="width: 25%;"> <p>Aluminum (black) (Legend: white)</p> </div> <div style="width: 25%;"> <p>NSA-0</p> </div> </div> <div style="display: flex; justify-content: space-between; margin-top: 10px;"> <div style="width: 25%;"> <p>With legend</p> </div> <div style="width: 25%;"> <p>NSA-□</p> </div> </div> <div style="display: flex; justify-content: space-between; margin-top: 10px;"> <div style="width: 25%;"> <p>NSALO</p> <p>1.2 mm thick</p> </div> <div style="width: 25%;"> <p>Blank</p> </div> <div style="width: 25%;"> <p>Aluminum (black)</p> </div> <div style="width: 25%;"> <p>NSALO</p> </div> </div> <div style="display: flex; justify-content: space-between; margin-top: 10px;"> <div style="width: 25%;"> <p>Blank</p> </div> <div style="width: 25%;"> <p>NSFO</p> <p>1.2 mm thick</p> </div> <div style="width: 25%;"> <p>Stainless Steel</p> </div> <div style="width: 25%;"> <p>NSFO</p> </div> </div>				

• Specify a legend code in place of □ in the Ordering No.

Legends

Code	Legend
0	(blank)
1	ON
2	OFF
3	START
4	STOP
31	OFF ON
35	HAND AUTO
53	HAND OFF AUTO











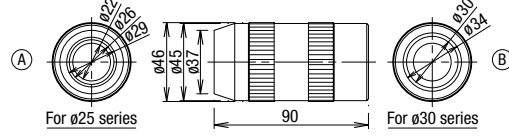

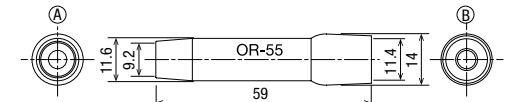

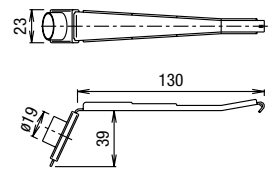
Engraving Area on Nameplates

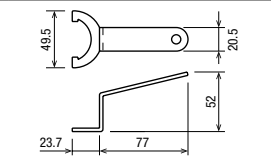
Shape	Engraving Area (mm)		Max. No. of Lines	No. of Letters per Line
	Height	Width		
<p>Standard (NSA/NFSO)</p>	4	31	1	17
<p>Mushroom (NSALO)</p>	8	31	2	17

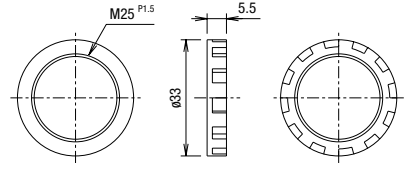
- The above example is when the letter is 3 mm tall.
- Engraving must be made within 1.5 mm from the sides.

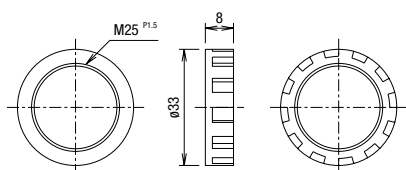

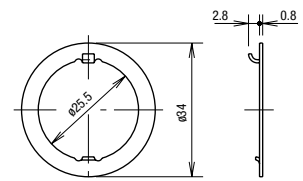

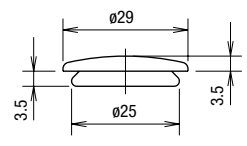



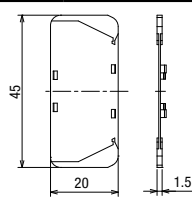

Accessories

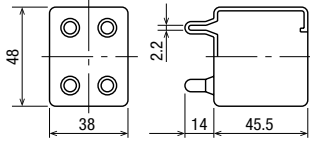
All dimensions in mm.

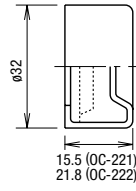
Shape		Material	Part No.	Ordering No.	Package Quantity	Dimensions
Tool	Locking Ring Wrench 	Nitril rubber	OR-12	OR-12	1	<ul style="list-style-type: none"> Used to tighten the round bezel when installing the TW switch onto a panel.  <p>For ø25 series For ø30 series</p>
	Lamp Holder Tool 	Nitril rubber	OR-55	OR-55	1	<ul style="list-style-type: none"> Used to install and remove the LED lamps. See page 31 for how to install. Ⓐ : BA9S Ⓑ : E12 
	Contact Block Removal Tool 	Zinc-plated metal Nitril rubber	TW-KC1	TW-KC1	1	<ul style="list-style-type: none"> Used to remove the transformer, to install/remove the waterproof lens and pilot light lens. 
	Nut Locking Wrench 	Metal (steel: zinc-plated)	TWST-T1	TWST-T1	1	<ul style="list-style-type: none"> Used to tighten the locking ring on the square switches/pilot lights. 
Locking Ring (for square units)	Pushbutton Illuminated Pushbutton 	Polyamide	OG-RT1	OG-RT1PN02	2	<ul style="list-style-type: none"> Used to attach square pushbuttons and illuminated pushbuttons on to the panel. Mounting centers are the same as round switches/pilot lights. 
	Pilot Light 	Polyamide	OG-RT2	OG-RT2PN02	2	<ul style="list-style-type: none"> Used to attach pilot lights on to the panel. Mounting centers are the same as round switches/pilot lights. 
Anti-rotation Ring 		Metal (steel: zinc-plated)	OGL-21	OGL-21PN10	10	<ul style="list-style-type: none"> Used to prevent the operator from rotating. Generally used when using no nameplates on selector switches. 
Rubber Mounting Hole Plug 	Black Nitril rubber Gray	OBS-13B OBS-13	OBS-13BPN05 OBS-13PN05	5	<ul style="list-style-type: none"> Used to plug unused ø25.5 mm mounting holes. Degree of protection: • IP65 (round mounting hole) • IP40 (with anti-rotation function) 	

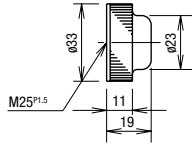
Accessories

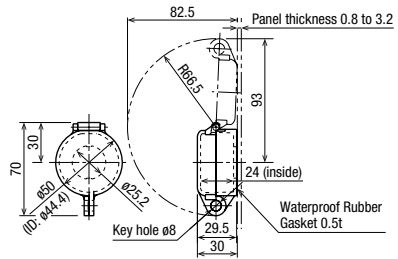
All dimensions in mm.

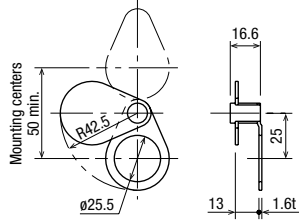
Shape	Material	Part No.	Ordering No.	Package Quantity	Dimensions															
	Polyamide	HW-VU1	HW-VU1PN10	10	<ul style="list-style-type: none"> Used to prevent contact between adjacent lead wires when units are mounted closely (see page 33 for details). Barriers should always be used in close mounting. 															
Contact Rubber Boot For 1 layer of contact blocks (2 contact blocks) 	Nitril rubber (black)	OCS-99	OCS-99	1	<ul style="list-style-type: none"> Oiltight rubber boot used for the contact blocks of pushbuttons and selector switches. Temperature range: -5 to +60°C  <p>When inserting a cable, cut the projection on the cover to match the cable size.</p>															
Button Clear Boot For flush pushbuttons For extended pushbuttons 	Rubber (EPDM)	OCS-221	OCS-221	1	<ul style="list-style-type: none"> Used to cover and protect pushbuttons where units are subject to water splash. Not suitable for outdoor use or where the units are subject to oil splash. To install, remove the bezel from TWS switch/pilot light, and place it in the cover. Then tighten the cover onto the TWS switch/pilot light. 															
		OCS-222	OCS-222	1																
Button Cover For extended pushbuttons 	Nitril rubber (black)	<table border="1"> <thead> <tr> <th>Color</th> <th>Part No.</th> <th>—</th> </tr> </thead> <tbody> <tr> <td>Black</td> <td>OCS-11B</td> <td>OCS-11B</td> </tr> <tr> <td>Green</td> <td>OCS-11G</td> <td>OCS-11G</td> </tr> <tr> <td>Red</td> <td>OCS-11R</td> <td>OCS-11R</td> </tr> <tr> <td>Yello</td> <td>OCS-11Y</td> <td>OCS-11Y</td> </tr> </tbody> </table>	Color	Part No.	—	Black	OCS-11B	OCS-11B	Green	OCS-11G	OCS-11G	Red	OCS-11R	OCS-11R	Yello	OCS-11Y	OCS-11Y		1	<ul style="list-style-type: none"> Metallic bezels covered with rubber boot to enhance waterproof and oiltight characteristics. Button is installed in the cover. Remove the button from the pushbutton before using the button cover. Temperature range: -5 to +60°C Extended button is not installed in the cover. Flush button must be replaced by extended button. 
Color	Part No.	—																		
Black	OCS-11B	OCS-11B																		
Green	OCS-11G	OCS-11G																		
Red	OCS-11R	OCS-11R																		
Yello	OCS-11Y	OCS-11Y																		
Padlock Cover 	Polyarylate (gasket: nitril rubber)	OLS-KL1	OLS-KL1	1	<ul style="list-style-type: none"> Used to protect momentary and maintained pushbuttons, illuminated pushbuttons, knob selector switches, and key selector switches. (Except for mushroom/mushroom with full shroud and keys) 															
Metal Protector 	Metal (steel: zinc-plated)	OLS-C	OLS-C	1	<ul style="list-style-type: none"> Used to protect flush buttons from inadvertent operation. Can be easily attached under the round bezel. 															









Accessories

All dimensions in mm.

Shape	Material	Part No.	Ordering No.	Package Quantity	Color Code * / Remarks		
Bezel 	① Metal (chromeplated) ZDC	OG-22	OG-22PN02	2	B (black), G (green), R (red), Y (yellow), W (white) •Cannot be used for switches/ pilot lights with half shroud or full shroud.		
	② Polycarbonate	OGP-22*	OGP-22*PN02				
	③ Metal (chromeplated) ZDC	OG-33	OG-33PN02	2		B (black), G (green), R (red), Y (yellow), W (white) •Cannot be used for switches/ pilot lights with half shroud or full shroud.	
	④ Polycarbonate	OGP-33*	OGP-33*PN02				
	⑤ Pushbutton with Full Shroud ø23.5, height 17	⑤⑥ Metal (chromeplated) ZDC	ABS2FN	ABS2FN	1		
	⑥ Mushroom with Full Shroud ø42, height 18		ABS3GN	ABS3GN			
	⑦ Pushbutton/ Illuminated Pushbutton with Half Shroud ø31, height 20.2	⑦ Half shroud: brass Others: chrome-plated ZDC	ALS1G	ALS1G	1	With locking ring (chromeplated brass)	
	⑧ Illuminated Pushbutton with Full Shroud ø30, height 19	⑧ Illumination shroud: chrome-plated ZDC	ALS1F	ALS1F			
Button 	Polycacetal	ABS1BN-*	ABS1BN-*PN05	5	B (black), G (green), R (red), S (blue), Y (yellow), W (white) • Light color		
		ABS2BN-*	ABS2BN-*PN05				
		ABS3BN-*	ABS3BN-*PN02	2			
		UBQS1BN-*	UBQS1BN-*PN02	2	B (black), G (green), R (red), S (blue), Y (yellow) • Light color		
		UBQS2BN-*	UBQS2BN-*PN02				
		AVS3BN-*	AVS3BN-*PN02	2	R (red), Y (yellow)		
		AYS3BN-*	AYS3BN-*PN02	2	B (black), G (green), R (red), Y (yellow)		
Lens (for pilot lights) 	AS resin	APS106LD-*K	APS106LD-*KPN05	5	G (green), R (red), S (blue), A (amber), W (white), Y (yellow) C (clear), G (green), R (red), S (blue), A (amber), Y (yellow) (Use clear lens for pure white illumination)		
		UPQS306LD-*K	UPQS306LD-*KPN05				
Lens (for pilot lights and illuminated pushbuttons) 	AS resin	UPQS106LD-*K	UPQS106LD-*KPN05	5	C (clear), G (green), R (red), S (blue), A (amber), Y (yellow) (Use clear lens for pure white illumination)		
Lens (for illuminated pushbuttons) 	AS resin	ALS06LD-*K	ALS06LD-*KPN05	5	G (green), R (red), S (blue), A (amber), Y (yellow), W (white)		
		AVLS3L-R-K	AVLS3L-R-KPN02	2			

Maintenance Parts



All dimensions in mm.

Shape	Material	Part No.	Ordering No.	Package Quantity	Color Code * / Remarks	
Selector Operator 	① Knob ø22.4, height 19	Polyacetal	ASSHHY-*	ASSHHY- *PN02	2	B (black), G (green), R (red)
	③ Color Insert Width 19, depth 5, height 18.5	Polyacetal	TWS-HC1*	TWS-HC1- *PN05	5	B (black), G (green), R (red), S (blue), Y (yellow), W (white)
	④ Illuminated Selector ø20.4, height 20.2	AS resin	ASLSDDY- *-K	ASLSDDY- *-K	1	G (green), R (red), S (blue), A (amber), W (white), Y (yellow)
Cap for Key Selector ø20.4, height 14 	Polyacetal	AKS2B-*	AKS2B- *PN05	5	B (black), R (red)	
Clears Button Cover 	① Clear Button Cover ø19.8, height 5	Polycarbonate	ABS1B-C	ABS1B- CPN05	5	B (black), G (green), R (red), W (white), Y (yellow) Used on flush pushbuttons to indicate a mark or a symbol engraved on the marking plate. The clear button cover holds the marking plate.
	② Marking Plate ø16.8, height 4.1	Polyacetal	TWS-0*	TWS-0- *PN10	10	
Marking Plate 	① For Square Pilot Lights and Illuminated Pushbuttons □21.2, thickness 1	Acrylic	UPQS106P-*	UPQS106P- *PN02	2	W (white), C (clear) Engraving area: □19.2, 0.5 mm thick max.
	② For Square Pilot Lights with Metal Bezel □20, thickness 2		UPQS306N-W	UPQS306N- WPN02		W (white) only Engraving area: □19.2, 0.5 mm thick max.
Contact Block HW-U 	Weight: 11 g (approx.)	1NO	HW-U10	HW-U10	1	Housing: Blue Push rod: Green -MAU: gold contact
			HW-U10-MAU	HW-U10-MAU		
		1NC	HW-U01	HW-U01	1	Housing: Purple red Push rod: Red -MAU: gold contact
			HW-U01-MAU	HW-U01-MAU		
		EM contact (early make)	HW-U10R	HW-U10R	1	Housing: Blue Push rod: Black -MAU: gold contact
			HW-U10R-MAU	HW-U10R-MAU		
LB contact (late break)	HW-U01R	HW-U01R	1	Housing: Purple red Push rod: White -MAU: gold contact		
	HW-U01R-MAU	HW-U01R-MAU				
Dummy Block 	Polyamide	HW-DB	HW-DB PN10	10	For HW-U contact blocks Used when total number of contact blocks and full voltage adapters is odd.	
Full Voltage Adapter For illuminated unit (*1) 	Polyamide	HW-GA1N	HW-GA1 NPN02	2	Applicable model: Illuminated pushbuttons Illuminated selector switches Applicable load (LED lamp) LSRD-6, LSTD-6 (6V AC/DC) LSRD-1, LSTD-1 (12V AC/DC) LSRD-2, LSTD-2 (24V AC/DC)	
Transformer (*1) 	100/110V AC	HW-T16	HW-T16	1	Applicable model: Pilot lights Illuminated pushbuttons Illuminated selector switches Applicable load (LED lamp) LSRD-6, LSTD-6 (6V AC/DC)	
	200/220V AC	HW-T26	HW-T26			
Contact Block Plug 	Polyamide	HW9Z-CBPL	HW9Z- CBPLPN10	10	Used to plug the hole in the center of contact block.	

*1) For use as maintenance parts. Do not use for expansion or remodelling purposes.

Maintenance Parts

All dimensions in mm.

Shape	Material	Part No.	Ordering No.	Package Quantity	Remarks
 Spare Key For Key Selector Switch Length 39 Width 19.7 Thickness 1.8	Metal (nickel-plated brass)	TW-SK-0	TW-SK-OPN02	2	
 Rubber Washer ① 3.0 mm thickness Outside diameter: ø33.8 Inside diameter: ø25.5 ② 1.5 mm thickness Outside diameter: ø33.8 Inside diameter: ø25.5	Rubber (synthetic soft vinyl)	OW-22	OW-22PN10	10	• Used to tighten mounting panels.
		OW-21	OW-21PN10		

TWS series LED Lamps

Dimensions	Rated Voltage	Current Draw		Part No.	Ordering No.	Package Quantity	Base
		DC	AC				
	6V AC/DC	10 mA	14 mA	LSRD-6	LSRD-6	1	BA9S/13
					LSRD-6PN10	10	
	12V AC/DC	7 mA	8 mA	LSRD-1	LSRD-1	1	
					LSRD-1PN10	10	
	24V AC/DC	7 mA	8 mA	LSRD-2	LSRD-2	1	
					LSRD-2PN10	10	

- Only one color is available for LSRD so there are no codes to specify the color in the part no.
- When replacing the LED with LSRD, the lens must also be replaced (see page 25).



LED lamps for replacing incandescent lamps

- Use the following replacement LED lamps to replace incandescent lamps.
- See TWS series LED lamps shown above for ordering.
- LED lamps may have different brightness/color hue compared with incandescent lamps.

Incandescent Lamp					Replacement LED Lamp		
Model (mm)	Part No.	Operating Voltage	Lamp Rating	Base	Part No.	Operating Voltage	Base
 Bulb: ø11 Length: 23	LS-6	6V AC/DC	1W (6V)	BA9S/13	LSRD-6	6V AC/DC	BA9S/13
	LS-8	12V AC/DC	1W (18V)		LSRD-1	12V AC/DC	
	LS-2	18V AC/DC	1W (24V)		LSRD-2	24V AC/DC	
	LS-3	24V AC/DC	1W (30V)				

- Only one color is available for LSRD so there are no codes to specify the color in the part no.
- When replacing the incandescent lamp with LSRD, the lens must also be replaced (see page 25).

Transformer

Shape	Rated Voltage	Operating Voltage Range	Ordering No.	Applicable Load
	100/110V AC	100/110V AC ±10%	TWR516	LSRD-6 (6V AC/DC, LED lamp) LSTD-6* (6V AC/DC, LED lamp)
	200/220V AC	200/220V AC ±10%	TWR526	
	400/440V AC	400/440V AC ±10%	TWR546	
	100/110V AC	100/110V AC ±10%	TWR512	LSRD-2 (24V AC/DC, LED lamp) LSTD-2* (24V AC/DC, LED lamp)
	200/220V AC	200/220V AC ±10%	TWR522	
	400/440V AC	400/440V AC ±10%	TWR542	

- Specify a color code in place of * in Part No. R (red), G (green), A (amber), S (blue), PW (pure white)
- Terminal cover (TWR-VL3) is installed on transformers as standard.
- Transformer is installed to one TWS series unit.

Specifications



Part No.	TWR5□6	TWR5□2
Operating Voltage	100/110V AC, 200/220V AC, 400/440V AC (50/60Hz)	
Current Draw	2.4VA	
Rated Insulation Voltage	600V	
Insulation Resistance	100 MΩ minimum (500V DC megger)	
Operating Temperature	-30 to +60°C (no freezing)	
Operating Humidity	35 to 85% RH (no condensation)	
Storage Temperature	-40 to +80°C (no freezing)	
Vibration Resistance	Damage limits: 30 Hz, amplitude 1.5 mm Operating extremes: 5 to 55 Hz, amplitude 0.5 mm	
Shock Resistance	Damage limits: 1,000 m/s ² Operating extremes: 100 m/s ²	
Dielectric Strength	2500V AC, 1 minute	
Terminal Screw	M3.5	
Applicable Wire	2 mm ² maximum, 2 wires maximum	
Weight (approx.)	87g	

Dimensions

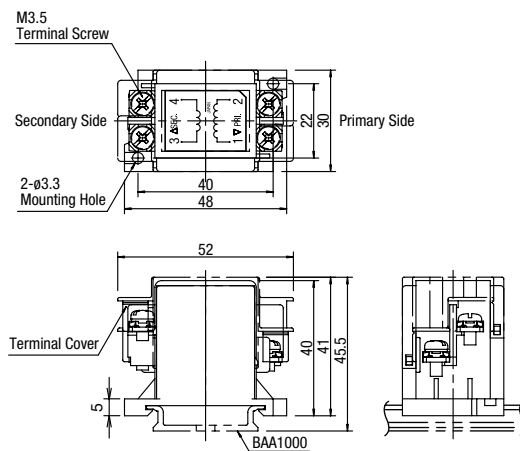
All dimensions in mm.

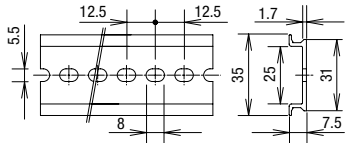

Accessories

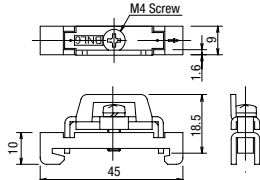
Shape	Material	Part No.	Ordering No.	Package Quantity	Dimensions (mm)
 Weight: 200g approx.	Aluminum Length: 1000 mm	BAA1000	BAA1000PN10	10	
 Weight: 15g approx.	Metal (zinc-plated steel) Applicable rail: BAA1000	BNL6	BNL6PN10	10	

⚠ Safety Precautions

- Turn off the power to the TWS series switches & pilot lights before starting installation, removal, wiring, maintenance, and starting installation, removing, wiring, maintenance, and inspection of the products. Failure to turn power off may cause electrical shocks or fire hazard.
- To avoid a burn on your hand, use the lamp holder tool when replacing lamps.

- For wiring, use wires of a proper size to meet the voltage and current requirements. Tighten the terminal screws to the recommended tightening torque (see page 34). Failure to tighten terminal screws may cause overheating and fire.
- When using a commercially available lamp, choose a lamp with rated voltage 5 to 30V AC/DC and 1W maximum, and with the same base and shape. Make sure of correct operation before installation. The operation of illuminated pushbutton switches cannot be guaranteed when a commercially available lamp is used.

Operating Instructions

Panel Mounting

1. Remove the locking ring from the operator and check that the rubber gasket is in place. For mushroom and jumbo mushroom switches, remove the button before removing the locking ring.
2. Adjust the thickness of the rubber washers according to the panel thickness.
3. Insert the switch into the panel from the back of the panel.
4. On the panel front, install the nameplate and locking ring. For mushroom and jumbo mushroom switches, install the button before installing the locking ring.

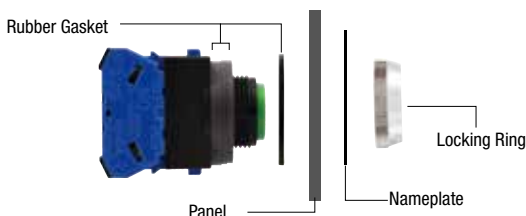

Panel Thickness and Rubber Washer

Adjust the thickness of the rubber washers according to the panel thickness as shown in the tables below. Also, make sure to include the nameplate thickness when using a nameplate.



Applicable Model

Pushbutton (momentary)
Pushbutton (mushroom w/full shroud)
Pilot light (round type)

Panel Thickness (mm)	Rubber Washer	
	1.5 mm-thick	3.0 mm-thick
Supplied	2 pieces	1
0.8 to 2.5	2 pieces	1
2.5 to 4.0	1	1
4.0 to 5.5	–	1
5.5 to 6.0	1	–

Pushbutton (momentary, extended w/half shroud)

Panel Thickness (mm)	Rubber Washer	
	1.5 mm-thick	3.0 mm-thick
Supplied	1	1
0.8	1	1
0.8 to 2.3	–	1
2.3 to 3.8	1	–

Pushbutton (maintained, extended w/half shroud)
Illuminated pushbutton (momentary/maintained extended w/half shroud)

Panel Thickness (mm)	Rubber Washer	
	1.5 mm-thick	3.0 mm-thick
Supplied	2 pieces	1
0.8	2 pieces	1
0.8 to 2.3	1	1
2.3 to 3.8	–	1
3.8 to 5.3	1	–

Pushbutton (momentary, extended w/full shroud)

Panel Thickness (mm)	Rubber Washer	
	1.5 mm-thick	3.0 mm-thick
Supplied	3 pieces	1
0.8 to 1.5	3 pieces	1
1.5 to 3.0	2 pieces	1
3.0 to 4.5	1	1
4.5 to 6.0	–	1

Pushbutton (maintained, extended with full shroud)

Panel Thickness (mm)	Rubber Washer	
	1.5 mm-thick	3.0 mm-thick
Supplied	4 pieces	1
0.8 to 1.5	4 pieces	1
1.5 to 3.0	3 pieces	1
3.0 to 4.5	2 pieces	1
4.5 to 6.0	1	1

Other models (excluding square type)

Panel Thickness (mm)	Rubber Washer	
	1.5 mm-thick	3.0 mm-thick
Supplied	3 pieces	1
0.8 to 2.5	3 pieces	1
2.5 to 4.0	2 pieces	1
4.0 to 5.5	1	1
5.5 to 6.0	–	1

Notes for Panel Mounting

Locking ring wrench recommended torque

Tighten the bezel to a tightening torque of 3.0 to 3.5 N·m.

Locking ring wrench

Locking ring wrench (OR-12) can be used to tighten the bezel. Use side A to tighten.

Side A: TWS series

Side B: For TWN/TWND series

Locking ring wrench (OR-12)



Installing the Anti-rotation Ring (OGL-11)

Anti-rotation rings are used on selector switches or pushbuttons which rotate and used when using no nameplates. Insert a 1.5 mm-thick rubber washer between the panel and the anti-rotation ring as shown on the right. To install, adjust the panel thickness by taking the thickness of anti-rotation ring (OGL-11) into consideration.

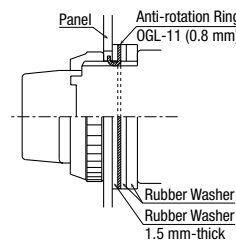

Replacement of LED Lamps

Lamps can be replaced by using the lamp holder tool (OR-55) from the front of the panel. (See page 25 for lamp holder tool.)

How to Remove

To remove, slip the lamp holder tool onto the lamp head lightly. Then push slightly, and turn the lamp holder tool counterclockwise.



How to Install

To install, insert the lamp head into the lamp holder tool. Place the two pins on the lamp base to the grooves in the lamp socket. Inset the lamp and turn it clockwise.



Operating Instructions

Installing/Removing the Buttons and Lenses

To install

To remove

Pushbutton button

Flush/Extended
Push in the button to install.



Insert a flat screwdriver between the button and the bezel to remove the button.



Mushroom/
Jumbo Mushroom
Button has threads.
Turn clockwise to install the button.



Turn the button counterclockwise to remove.



Illuminated Pushbutton Lens

Extended
Lens has threads. Turn clockwise to install the lens.



Turn the lens counterclockwise to remove.



Pilot Light Lens

Round
Lens has threads.
Turn clockwise to install the lens.



Turn the lens counterclockwise to remove.



A rubber gasket is installed between the lens and operator on pilot lights. Make sure that the rubber gasket is in place when installing the lens.

Notes on Square Units on Panel

- 1) Position the square bezel correctly. Make sure that it is tightened securely.
- 2) The square bezel can be retained securely by tightening the screws lightly.
- 3) Do not turn the square bezel after the screws are tightened, otherwise it may come off.

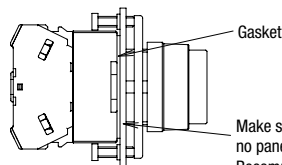

Installing Square Lenses

Lens Structure and Marking Plate

All square lens units are marking types. To engrave on the marking plate, remove the marking plate from the lens.

• Square Pilot Lights

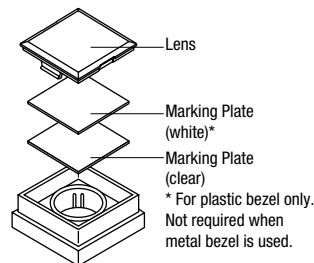

• Square Illuminated Pushbuttons

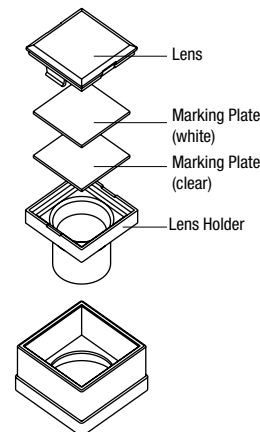

Operating Instructions

Marking Plate on Pilot Lights/Illuminated Pushbuttons

Rectangular Marking Plates

Removing

- ① Insert a flat screwdriver between the lens and bezel, and tilt the screwdriver to remove the lens.
- ② In metal bezel, a white marking plate is installed in the lens. It can be removed easily.



<Plastic Bezel>

A white marking plate and a clear marking plate installed in the lens can be removed by inserting a flat screwdriver.

Engraving Area

- For UPQS1B square pilot light (plastic bezel)
- For ULQS1B/UOLQS1B square flush illuminated pushbutton

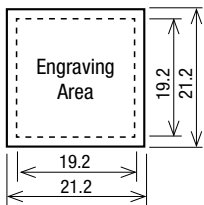

Material: Acrylic resin
Thickness: 1.0 mm
Depth: 0.5 mm

Collective Mounting

When mounting the units closely in a horizontal row on 30-mm centers, use optional barriers (HW-VU1) to prevent interconnection between adjoining terminals. The barriers can be attached simply by pressing them onto the sides of contact blocks.

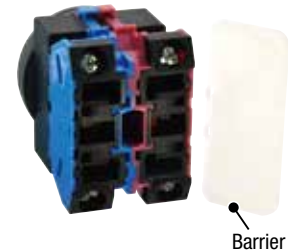
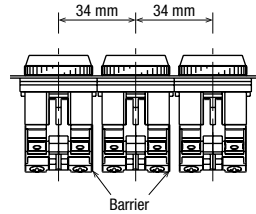

- Sufficient insulation distance cannot be obtained if barriers are not installed, or when other barriers such as HW-VG1 is used.

Notes on Wiring Transformer Type Units

When using transformer type illuminated TWS series of 240V AC maximum closely in a horizontal row on 34 mm centers, insert straight the solid wires or stranded wires into inside of the terminal screw on the transformer (see figure below) to prevent short circuit between adjoining terminals.

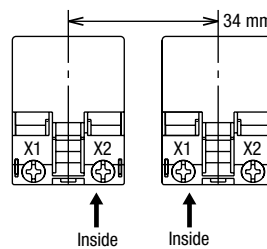

Enlarged View of Terminal Part

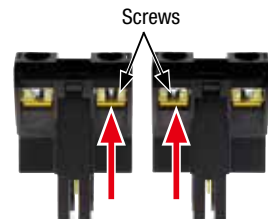

Selector Switches

Turn the operator such as knob, lever, and key to each position accurately. Releasing halfway may cause the operator to return to the former position, or to get stuck between. On spring return two-way types, the center of operators may be misaligned slightly.

Key Selector Switches

Insert the key completely before turning. Failure to do so may cause failures.

Operating Instructions

Installing the Operator on Selector Switches

(1) Install the switch with TOP marking facing upward, so that the operator can be installed on the switch in the correct direction.



(2) On non-illuminated models, install the color insert in the middle of operator. The color insert also serves to retain the operator.



(3) On illuminated models, align the operator with the switch by confirming the TOP marking on the switch and also the switch operation. Then press in the operator into the switch.



Installation of Selector Operators

The shaft of each non-illuminated selector switch has a recess to identify the direction to install the operator. Align the operator with the recess and press in the operator. Press a color insert (non-illuminated) into the operator (illuminated selector switches do not have a recess on the shaft).

Non-illuminated Selector Switches

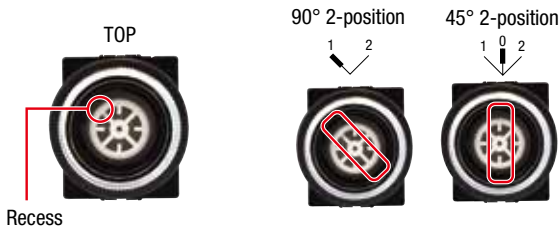

In addition to the standard positions shown below, the non-illuminated operators can be installed 45° intervals.

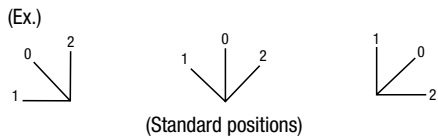

Illuminated Selector Switches



In addition to the standard positions shown below, the non-illuminated operators can be installed 45° intervals.

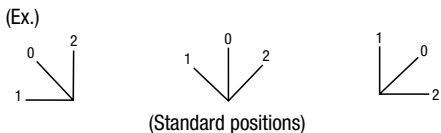

Removal

Non-illuminated Selector Switches

Insert a flat screwdriver with tip width 4.5 mm maximum into the recess under the color insert. Turn the screwdriver to push out the insert from the operator.



A tapping screw is used to fasten the Pull out the operator sideways as shown in the left photo to remove the operator.



Illuminated Selector Switches

Insert a flat screwdriver with tip width 5 mm maximum into the recess opposite from the color insert and tilt. The operator is displaced slightly.



Removing the Contact Blocks/Full Voltage Adapters

Insert a flat screwdriver (4 to 6 mm) into the snap-fit latches of the contact block or full voltage adapter and lift to remove.

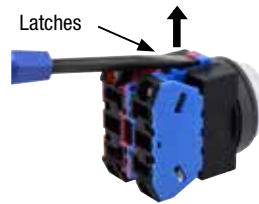

- Make sure to lift both latches. Contact blocks cannot be removed by lifting one latch only.
- Do not apply excessive force to the latches, otherwise damage may be caused.

Transformer Units and DC-DC Converters

Insert the end of the contact block removal tool (TW-KC1) into the snap-fit latch of the transformer units or DC-DC converter and pull the tool forward. The contact block removable tool cannot be used to remove the contact blocks (HW-U), full voltage adapters (HW-GA1N), or dummy blocks (HW-DB).

Illuminated Pushbuttons/Illuminated Selector Switches

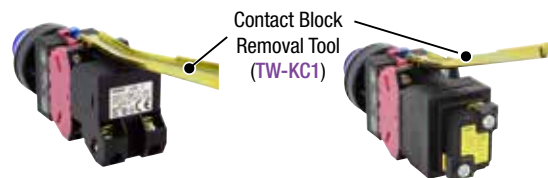

Pilot Lights

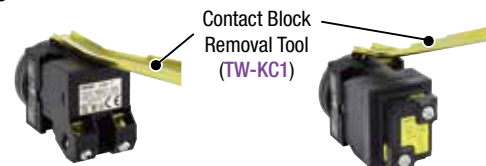

Notes on Replacing Units

When replacing parts (contact block, dummy block, full voltage adapter, transformer) for maintenance, make sure to install the parts to the original position. Otherwise proper operation cannot be guaranteed.

Operating Instructions

Applicable Wiring

(1) Contact Block 0.3 to 3.5 mm² (solid wire ø0.5 to 2.0 mm)
 Pushbutton/illuminated pushbutton/selector switch/
 illuminated selector switch

Ⓐ and Ⓑ show the wiring direction to the terminals.

<Contact Block>

Terminal screws M3.5
 (spring-up)

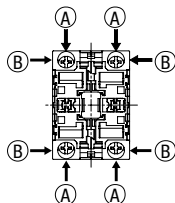

Applicable Crimping Terminal

Be sure to use an insulation tube or cover on the crimping part of the crimping terminal to prevent electrical shocks.

Crimping terminal for Ⓐ

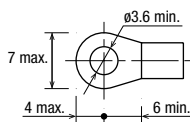
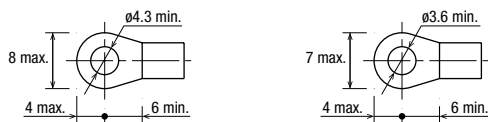

IP20 crimping terminal

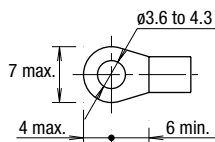

Crimping terminal for Ⓑ

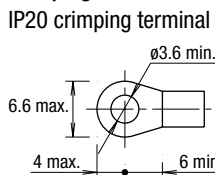

Solid wire

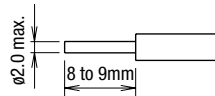

- Strip the wire insulation 8 to 9 mm from the end.
- Insert the wire until the insulation comes into contact with the terminal metal part.

(1)-1 IP20 Degree of Protection

The terminal of HW-U contact block has IP20 degree of protection.
 When IP20 is required for wiring, observe the followings.
 Make sure to insert the crimping terminal or wire to the terminal straight and fully.

When using a crimping terminal

Use IP20 crimping terminals.

When using a solid wire

Strip the wire insulation 8 to 9 mm from the end and insert the wire to the terminal fully.

When using a stranded wire

Strip the wire insulation 8 to 9 mm from the end and insert the wire to the terminal fully. Make sure that the wires are not loosened.

(2) Power Unit 0.3 to 2 mm² (solid wire ø0.5 to 1.6 mm)

Illuminated pushbutton/illuminated selector switch

Ⓐ and Ⓑ show the wiring direction to the terminals.

<Full Voltage Adapter>

Terminal screws M3.5
 (spring-up)

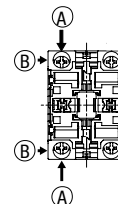

<Transformer Unit>

100/110V AC, 200/220V AC

Terminal screws M3.5
 (spring-up)

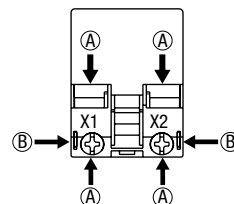

<DC-DC Converter Unit/Transformer Unit>

110V DC, 380V AC minimum

Terminal screws M3.5
 (spring-up)

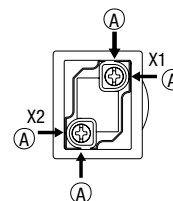

Applicable Crimping Terminal

Be sure to use an insulation tube or cover on the crimping part of the crimping terminal to prevent electrical shocks.

Crimping terminal for Ⓐ

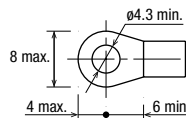

Crimping terminal for Ⓑ

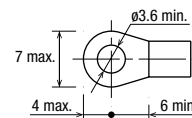

Solid wire

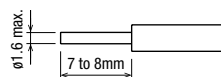

- Strip the wire insulation 7 to 8 mm from the end.
- Insert the wire until the insulation comes into contact with the terminal metal part.

- Terminal cover is integrated in the full voltage adapter and transformer unit. Note that the connection terminal is not IP20.

Operating Instructions

(3) Pilot Light 0.3 to 2 mm² (solid wire ø0.5 to 1.6 mm)

Applicable crimping terminal

Be sure to use an insulation tube or cover on the crimping part of the crimping terminal to prevent electrical shocks.

<Full Voltage Type>

6V, 12V, 24V AC/DC
Terminal screws M3.5 (self-lifting)

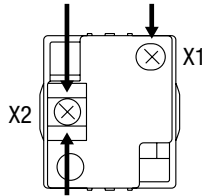
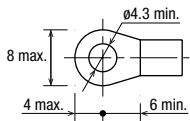

<Transformer Unit>

100/110V AC, 200/220V AC (240V AC maximum)
Terminal screws M3.5 (spring-up)

Crimping terminal for (A)

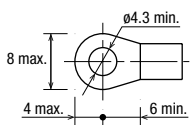

Crimping terminal for (B)

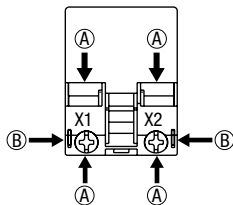
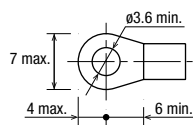

<DC-DC Converter Unit/Transformer Unit>

110V DC, 380V AC minimum
Terminal screws M3.5 (spring-up)

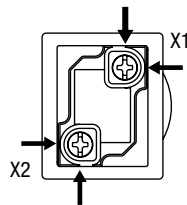
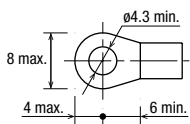

Solid wire

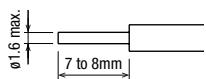

- Strip the wire insulation 7 to 8 mm from the end.
- Insert the wire until the insulation comes into contact with the terminal metal part.

- Install a terminal cover to 6, 12, 24V AC types. The connection terminal is not IP20.
- Terminal cover is integrated in the transformer and DC-DC converter unit. Note that the connection terminal is not IP20.
- When selecting mounting centers and crimping terminals, take sufficient insulation distance into consideration.

Cautions for Wiring

About using DC-DC Converter Unit

1. Note the polarity for wiring when connecting to the DC-DC converter.

Terminal No.	Polarity
X1	Positive
X2	Negative

- 2. Incandescent lamps cannot be used in DC-DC converter unit.
- 3. DC-DC converters are equipped with an electric circuit and noise may be heard inside the unit, which does not affect the performance of DC-DC converters.

Recommended Tightening Torque Number of Wires

Unit	Wire	Number of Wires	Recommended Tightening Torque	Terminal Screw	
HW-U Contact Block	Crimping Terminal	2	1.0 to 1.3	M3.5	
	Solid Wire	ø0.5 to 1.6 mm (AWG14 to 22)	2		1.0 to 1.3
		ø1.7 to 2.0 mm (AWG12)	1		1.2 to 1.3
	Stranded Wire	0.3 to 2.0 mm ² (AWG14 to 22)	2		1.0 to 1.3
2.1 to 3.5 mm ² (AWG12)		1	1.2 to 1.3		
Illuminated Unit (*1)	Crimping Terminal	2	1.0 to 1.3	M3.5	
	Solid Wire				ø0.5 to 1.6 mm (AWG14 to 22)
	Stranded Wire				0.3 to 2.0 mm ² (AWG14 to 22)
Pilot Light	Crimping Terminal	2	1.0 to 1.3	M3.5	
	Solid Wire				ø0.5 to 1.6 mm (AWG14 to 22)
	Stranded Wire				0.3 to 2.0 mm ² (AWG14 to 22)

*1) Lamp terminal of illuminated pushbuttons and illuminated selector switches

Ordering Terms and Conditions

Thank you for using IDEC Products.

By purchasing products listed in our catalogs, datasheets, and the like (hereinafter referred to as "Catalogs") you agree to be bound by these terms and conditions. Please read and agree to the terms and conditions before placing your order.

1. Notes on contents of Catalogs

- (1) Rated values, performance values, and specification values of IDEC products listed in this Catalog are values acquired under respective conditions in independent testing, and do not guarantee values gained in combined conditions.
Also, durability varies depending on the usage environment and usage conditions.
- (2) Reference data and reference values listed in Catalogs are for reference purposes only, and do not guarantee that the product will always operate appropriately in that range.
- (3) The specifications / appearance and accessories of IDEC products listed in Catalogs are subject to change or termination of sales without notice, for improvement or other reasons.
- (4) The content of Catalogs is subject to change without notice.

2. Note on applications

- (1) If using IDEC products in combination with other products, confirm the applicable laws / regulations and standards.
Also, confirm that IDEC products are compatible with your systems, machines, devices, and the like by using under the actual conditions. IDEC shall bear no liability whatsoever regarding the compatibility with IDEC products.
- (2) The usage examples and application examples listed in Catalogs are for reference purposes only. Therefore, when introducing a product, confirm the performance and safety of the instruments, devices, and the like before use. Furthermore, regarding these examples, IDEC does not grant license to use IDEC products to you, and IDEC offers no warranties regarding the ownership of intellectual property rights or non-infringement upon the intellectual property rights of third parties.
- (3) When using IDEC products, be cautious when implementing the following.
 - i. Use of IDEC products with sufficient allowance for rating and performance
 - ii. Safety design, including redundant design and malfunction prevention design that prevents other danger and damage even in the event that an IDEC product fails
 - iii. Wiring and installation that ensures the IDEC product used in your system, machine, device, or the like can perform and function according to its specifications
- (4) Continuing to use an IDEC product even after the performance has deteriorated can result in abnormal heat, smoke, fires, and the like due to insulation deterioration or the like. Perform periodic maintenance for IDEC products and the systems, machines, devices, and the like in which they are used.
- (5) IDEC products are developed and manufactured as general-purpose products for general industrial products. They are not intended for use in the following applications, and in the event that you use an IDEC product for these applications, unless otherwise agreed upon between you and IDEC, IDEC shall provide no guarantees whatsoever regarding IDEC products.
 - i. Use in applications that require a high degree of safety, including nuclear power control equipment, transportation equipment (railroads / airplanes / ships / vehicles / vehicle instruments, etc.), equipment for use in outer space, elevating equipment, medical instruments, safety devices, or any other equipment, instruments, or the like that could endanger life or human health
 - ii. Use in applications that require a high degree of reliability, such as provision systems for gas / waterworks / electricity, etc., systems that operate continuously for 24 hours, and settlement systems
 - iii. Use in applications where the product may be handled or used deviating from the specifications or conditions / environment listed in the Catalogs, such as equipment used outdoors or applications in environments subject to chemical pollution or electromagnetic interference
If you would like to use IDEC products in the above applications, be sure to consult with an IDEC sales representative.

3. Inspections

We ask that you implement inspections for IDEC products you purchase without delay, as well as thoroughly keep in mind management/maintenance regarding handling of the product before and during the inspection.

4. Warranty

- (1) Warranty period
The warranty period for IDEC products shall be one (1) year after purchase or delivery to the specified location. However, this shall not apply in cases where there is a different specification in the Catalogs or there is another agreement in place between you and IDEC.
- (2) Warranty scope
Should a failure occur in an IDEC product during the above warranty period for reasons attributable to IDEC, then IDEC shall replace or repair that product, free of charge, at the purchase location / delivery location of the product, or an IDEC service base. However, failures caused by the following reasons shall be deemed outside the scope of this warranty.
 - i. The product was handled or used deviating from the conditions / environment listed in the Catalogs
 - ii. The failure was caused by reasons other than an IDEC product
 - iii. Modification or repair was performed by a party other than IDEC
 - iv. The failure was caused by a software program of a party other than IDEC
 - v. The product was used outside of its original purpose
 - vi. Replacement of maintenance parts, installation of accessories, or the like was not performed properly in accordance with the user's manual and Catalogs
 - vii. The failure could not have been predicted with the scientific and technical standards at the time when the product was shipped from IDEC
 - viii. The failure was due to other causes not attributable to IDEC (including cases of force majeure such as natural disasters and other disasters)Furthermore, the warranty described here refers to a warranty on the IDEC product as a unit, and damages induced by the failure of an IDEC product are excluded from this warranty.

5. Limitation of liability

The warranty listed in this Agreement is the full and complete warranty for IDEC products, and IDEC shall bear no liability whatsoever regarding special damages, indirect damages, incidental damages, or passive damages that occurred due to an IDEC product.

6. Service scope

The prices of IDEC products do not include the cost of services, such as dispatching technicians. Therefore, separate fees are required in the following cases.

- (1) Instructions for installation / adjustment and accompaniment at test operation (including creating application software and testing operation, etc.)
- (2) Maintenance inspections, adjustments, and repairs
- (3) Technical instructions and technical training
- (4) Product tests or inspections specified by you

The above content assumes transactions and usage within your region. Please consult with an IDEC sales representative regarding transactions and usage outside of your region. Also, IDEC provides no guarantees whatsoever regarding IDEC products sold outside your region.

IDEC CORPORATION

Head Office

6-64, Nishi-Miyahara-2-Chome, Yodogawa-ku, Osaka 532-0004, Japan

USA	IDEC Corporation	Tel: +1-408-747-0550	opencontact@idec.com
Germany	APEM GmbH	Tel: +49-40-25 30 54-0	service@eu.idec.com
Singapore	IDEC Izumi Asia Pte. Ltd.	Tel: +65-6746-1155	info@sg.idec.com
Thailand	IDEC Asia (Thailand) Co., Ltd	Tel: +66-2-392-9765	sales@th.idec.com
India	IDEC Controls India Private Limited	Tel: +91-80679-35328	info_india@idec.com
Taiwan	IDEC Taiwan Corporation	Tel: +886-2-2577-6938	service@tw.idec.com

 www.idec.com

Hong Kong	IDEC Izumi (H.K.) Co., Ltd.	Tel: +852-2803-8989	info@hk.idec.com
China	IDEC (Shanghai) Corporation	Tel: +86-21-6135-1515	idec@cn.idec.com
	Beijing Branch	Tel: +86-10-6581-6131	idec@cn.idec.com
	Guangzhou Branch	Tel: +86-20-8362-2394	idec@cn.idec.com
Japan	IDEC Corporation	Tel: +81-6-6398-2527	jp_marketing@idec.com

Specifications and other descriptions in this brochure are subject to change without notice.

