

LCD Temperature/Humidity Controllers



TH4M Series PRODUCT MANUAL

For your safety, read and follow the considerations written in the instruction manual, other manuals and Autonics website.

The specifications, dimensions, etc are subject to change without notice for product improvement. Some models may be discontinued without notice.

Features

- Simultaneous control of temperature and humidity
- LCD display with easy-to-read white and blue characters
- Input correction of temperature and humidity
- Output delay time setting
- Deviation high/low-limit alarm output
- Dedicated temperature/humidity sensor THD-RM (accessory)

Safety Considerations

- Observe all 'Safety Considerations' for safe and proper operation to avoid hazards.
- ⚠ symbol indicates caution due to special circumstances in which hazards may occur.

⚠ Warning Failure to follow instructions may result in serious injury or death

- 01. Fail-safe device must be installed when using the unit with machinery that may cause serious injury or substantial economic loss.** (e.g. nuclear power control, medical equipment, ships, vehicles, railways, aircraft, combustion apparatus, safety equipment, crime/disaster prevention devices, etc.)
Failure to follow this instruction may result in personal injury, economic loss or fire.
- 02. Do not use the unit in the place where flammable/explosive/corrosive gas, high humidity, direct sunlight, radiant heat, vibration, impact or salinity may be present.**
Failure to follow this instruction may result in explosion or fire.
- 03. Install on a device panel to use.**
Failure to follow this instruction may result in fire or electric shock.
- 04. Do not connect, repair, or inspect the unit while connected to a power source.**
Failure to follow this instruction may result in fire or electric shock.
- 05. Check 'Connections' before wiring.**
Failure to follow this instruction may result in fire.
- 06. Do not disassemble or modify the unit.**
Failure to follow this instruction may result in fire or electric shock.

⚠ Caution Failure to follow instructions may result in injury or product damage

- 01. When connecting the power input and relay output, use AWG 20 (0.50 mm²) cable or over, and tighten the terminal screw with a tightening torque of 0.74 to 0.90 N m.**
When connecting the sensor input and communication cable without dedicated cable, use AWG 28 to 16 cable and tighten the terminal screw with a tightening torque of 0.74 to 0.90 N m.
Failure to follow this instruction may result in fire or malfunction due to contact failure.
- 02. Use the unit within the rated specifications.**
Failure to follow this instruction may result in fire or product damage
- 03. Use a dry cloth to clean the unit, and do not use water or organic solvent.**
Failure to follow this instruction may result in fire or electric shock.
- 04. Keep the product away from metal chip, dust, and wire residue which flow into the unit.**
Failure to follow this instruction may result in fire or product damage.

Cautions during Use

- Follow instructions in 'Cautions during Use'. Otherwise, it may cause unexpected accidents.
- Check the polarity of the terminals before wiring the temperature/humidity sensor. Use the cables in same thickness and length. Use the designated compensation wire for extending wire.
- Keep away from high voltage lines or power lines to prevent inductive noise. In case installing power line and input signal line closely, use line filter or varistor at power line and shielded wire at input signal line. Do not use near the equipment which generates strong magnetic force or high frequency noise.
- Do not apply excessive power when connecting or disconnecting the connectors of the product.

- Install a power switch or circuit breaker in the easily accessible place for supplying or disconnecting the power.
- Do not use the unit for other purpose (e.g. voltmeter, ammeter), but temperature/humidity controller.
- When changing the input sensor, turn off the power first before changing. After changing the input sensor, modify the value of the corresponding parameter.
- Make a required space around the unit for radiation of heat. For accurate temperature measurement, warm up the unit over 20 min after turning on the power.
- Make sure that power supply voltage reaches to the rated voltage within 2 sec after supplying power.
- Do not wire to terminals which are not used.
- This unit may be used in the following environments.
 - Indoors (in the environment condition rated in 'Specifications')
 - Altitude Max. 2,000 m
 - Pollution degree 2
 - Installation category II

Ordering Information

This is only for reference, the actual product does not support all combinations. For selecting the specified model, follow the Autonics website.

TH 4 ① - ② ③ ④

① Size

M: DIN W 72 × H 72 mm

② Option I/O

2: Alarm 1/2 output

③ Power supply

4: 100 - 240 VAC

④ Control output

R: Relay 2-stage

Product Components

- Product (+ bracket)
- Temperature/Humidity sensor THD-RM
- Instruction manual

Sold Separately

- Terminal protection cover: RMA-COVER

Unit Descriptions

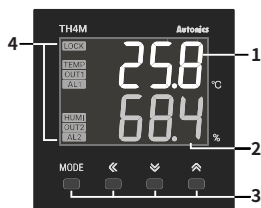

1. Temperature display part (White)

- Run mode: displays temperature PV (Present value)
- Setting mode: displays parameter name

2. Humidity display part (Blue)

- Run mode: displays humidity SV (Setting value)
- Setting mode: displays parameter setting value

3. Input key

Display	Name
[MODE]	Mode key
[◀], [▼], [▲]	Setting value control key

4. Indicator

Display	Name	Description
LOCK	Lock	Turns ON when lock function is activated (parameter)
TEMP	Temperature control	Turns ON when temperature control is ON
HUMI	Humidity control	Turns ON when humidity control is ON
OUT1/2	Control output	Turns ON when the control output is ON
AL1/2	Alarm output	Turns ON when the alarm output is ON

Crimp Terminal Specifications

- Unit: mm, Use the crimp terminal of follow shape.

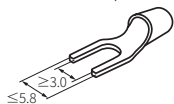

Fork crimp terminal

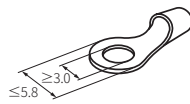

Round crimp terminal

Dimensions

- Unit: mm, For the detailed drawings, follow the Autonics website.

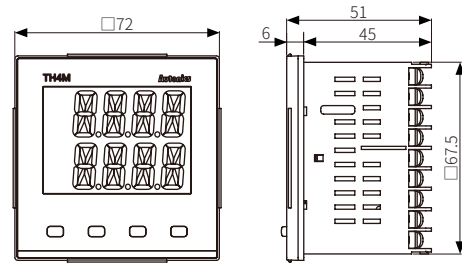

■ Panel cut-out

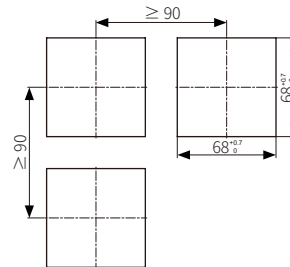

■ Bracket

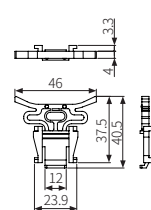

■ Temperature/Humidity sensor

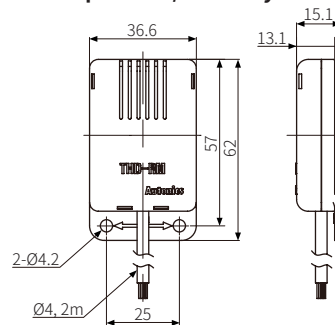

Installation Method

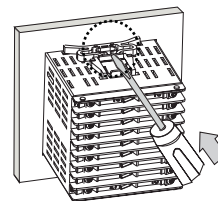

Flathead screwdriver

Insert the unit into a panel, fasten the bracket by pushing with tools with a flathead screwdriver.

■ Temperature/Humidity sensor

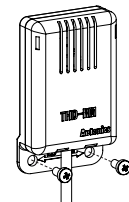

- Mounts sensor with M2 bolt and tighten screws by torque from 0.5 to 0.9 N.m.
- Do not impact on the unit with hard objects and do not bend the cable part too much. It may cause damage.

Connections

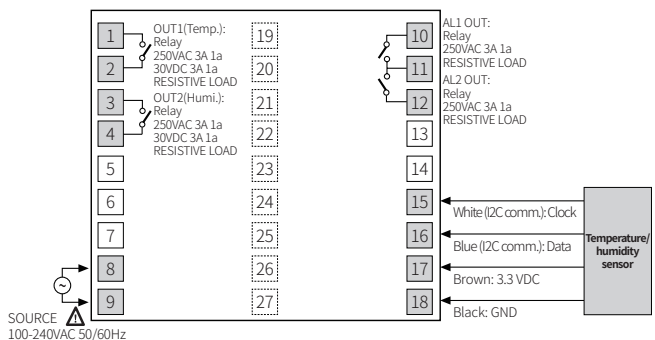

Specifications

Model	TH4M-24R		
Power supply	100 - 240 VAC ~ 50/60 Hz		
Permissible voltage range	90 to 110 % of rated voltage		
Power consumption	≤ 8 VA		
Sampling period	1 sec		
Display accuracy	Temperature	<ul style="list-style-type: none"> At room temperature (25 °C ± 5 °C): ≤ ± 1.0 °C Out of room temperature range: ≤ ± 2.0 °C 	
	Humidity	<ul style="list-style-type: none"> At room temperature (25 °C ± 5 °C): ≤ ± 3.0%RH (20 to 90%RH), ≤ ± 5.0%RH (below 20%RH, over 90%RH) Out of room temperature: ≤ ± 5.0%RH (all range) 	
Display range	Temperature	-20.0 to 60.0 °C	
	Humidity	10.0 to 100.0%RH	
Using range	Temperature	-20.0 to 60.0 °C	
	Humidity	10.0 to 100.0%RH	
Control output ⁰¹⁾	Temperature (OUT1)	Relay: 250 VAC ~ 3 A, 30 VDC ~ 3 A, 1 A	
	Humidity (OUT2)	Relay: 250 VAC ~ 3 A, 30 VDC ~ 3 A, 1 A	
Alarm output	Relay	AL1/2: 250 VAC ~ 3 A, 1 A	
Display type ⁰²⁾	11-Segment (temperature: white, humidity: blue), other display (yellow) LCD type		
Control type	ON/OFF control		
Relay life cycle	Mechanical	≥ 5,000,000 operations	
	Electrical	≥ 200,000 operations (resistance load: 250 VAC ~ 3 A)	
Dielectric strength	Between the charging part and the case : 3,000 VAC ~ 50/60 Hz for 1 min		
Vibration	0.75 mm amplitude at frequency 5 to 55Hz in each X, Y, Z direction for 2 hours		
Insulation resistance	≥ 100 MΩ (500 VDC = megger)		
Noise immunity	± 2 kV square shaped noise (pulse width 1 μs) by noise simulator R-phase, S-phase		
Memory retention	≈ 10 years (non-volatile semiconductor memory type)		
Ambient temperature	-10 to 50 °C, storage: -20 to 60 °C (no freezing or condensation)		
Ambient humidity	35 to 85%RH, storage: 35 to 85%RH (no freezing or condensation)		
Insulation type	Double or reinforced insulation (mark: □), dielectric strength between primary circuit and secondary circuit: 3 kV)		
Certification	CE UK		
Unit weight	≈ 144 g		

01) Connect to a load using the same power supply. Connecting to a load from a different power supply may cause safety issues.

02) When using the unit at low temperature (below 0°C), display cycle is slow.

■ Temperature/Humidity sensor

Model	THD-RM		
Power supply	3.3 VDC ± 2%		
Power consumption	≤ 1.3mA		
Response time	15 sec		
Sensing accuracy	Temperature	<ul style="list-style-type: none"> At room temperature (25 °C ± 5 °C): ≤ ± 1.0 °C Out of room temperature: ≤ ± 2.0 °C 	
	Humidity	<ul style="list-style-type: none"> At room temperature (25 °C ± 5 °C): ≤ ± 3.0%RH (20 to 90%RH), ≤ ± 5.0%RH (below 20%RH, over 90%RH) Out of room temperature: ≤ ± 5.0%RH (all range) 	
Sensing range	Temperature	-20.0 to 60.0 °C	
	Humidity	10.0 to 100.0%RH	
Communication type	I2C communication output		
Dielectric strength	Between the charging part and the case : 500 VAC ~ 50/60 Hz for 1 min		
Vibration	0.75 mm amplitude at frequency 5 to 55Hz in each X, Y, Z direction for 2 hours		
Ambient temperature	-20 to 60 °C, storage: -20 to 60 °C (no freezing or condensation)		
Ambient humidity	0 to 100%RH, storage: 35 to 85%RH (no freezing or condensation)		
Cable	Ø4 mm, 4-core, 2 m (tensile strength: 1kgf/s)		
Certification	CE UK		
Unit weight	≈ 56 g		

Initial Display When Power is ON

When power is supplied, after all display will flash for 1 sec, model name is displayed sequentially. After input sensor type will flash twice, enter into RUN mode.

Display	1. All	2. Model	3. RUN mode
Temperature	00.00	TH4M	55.0
Humidity	00.00	24R	42.8

Errors

Indicator	Display	Description	Trouble shooting
Temperature	Flashes $\sigma P E n$	Flashes when input sensor is disconnected or sensor is not connected.	Check input sensor status.
Humidity	Turns on $HHHH$ ⁰¹⁾	Turns on when measured value is higher than input range.	When input is within the rated input range, this display disappears.
Temperature	Fixes maximum value		
Temperature	Turns on $LLLL$ ⁰¹⁾	Turns on when measured value is lower than input range.	
Humidity	Fixes minimum value		

01) Be careful that when $HHHH / LLLL$ error occurs, the control output may occur by recognizing the maximum or minimum input depending on the control type.

Mode Setting

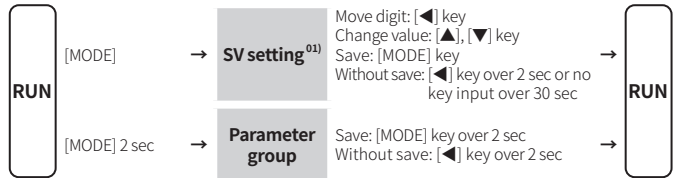

01) When entering SV setting mode, temperature SV setting mode appears. After that, when saving or not saving SV, it enters the sequence of humidity SV setting and RUN mode. In temperature SV setting mode, TEMP indicator lights up, and in humidity SV setting mode, HUMI indicator lights up.

Parameter Setting

- [MODE] key: Move to next item after saving / Return to RUN mode after saving (≥ 2 sec)
- [Left Arrow] key: Move digits / Return to RUN mode without saving (≥ 2 sec)
- [Up Arrow], [Down Arrow] key: Select parameter group / Change setting value
- TEMP indicator is ON in temperature related parameter, and HUMI indicator is ON in humidity related parameter.
- The control is operated during parameter setting.

■ Temperature parameter setting group [TEMP]

Parameter	Display	Default	Setting range
T-1 Control output mode	$\sigma - F E$	HE RE	HEAT: Heating, COOL: Cooling
T-2 Hysteresis	HY5	1.0	0.1 to 19.9 °C
T-3 Delay time	dL 5t	0	0 to 600 sec
T-4 Input correction	i N - b	0.0	-10.0 to 10.0 °C
T-5 Sensor error, MV	ER MV	$\sigma F F$	OFF, ON
T-6 Temperature SV low limit	L - 5V	- 2.0	-20.0 to [H-SV] - 0.1 °C
T-7 Temperature SV high limit	H - 5V	6.0	[L-SV] + 0.1 to 60.0 °C

■ Humidity parameter setting group [HUMI]

Parameter	Display	Default	Setting range
H-1 Control output mode	$\sigma - F E$	HE RE	HEAT: Heating, COOL: Cooling
H-2 Hysteresis	HY5	1.0	0.1 to 19.9 %RH
H-3 Delay time	dL 5t	0	0 to 600 sec
H-4 Input correction	i N - b	0.0	-10.0 to 10.0 %
H-5 Sensor error, MV	ER MV	$\sigma F F$	OFF, ON
H-6 Humidity SV low limit	L - 5V	1.0	10.0 to [H-SV] - 0.1 %RH
H-7 Humidity SV high limit	H - 5V	10.0	[L-SV] + 0.1 to 100.0 %RH

■ Additional parameter setting group [ADD]

Parameter	Display	Default	Setting range
A-1 Input digital filter	MAVF	1.0	0.1 to 100.0
A-2 Temperature alarm operation ⁰¹⁾	AL ME	AL MD	AM0: Off AM1: Deviation high limit alarm AM2: Deviation low limit alarm AM3: Deviation high, low limit alarm
A-3 Temperature alarm value	AL t	15.5	-155.0 to 155.0 °C
A-4 Humidity alarm operation ⁰¹⁾	AL MH	AL MD	AM0: Off AM1: Deviation high limit alarm AM2: Deviation low limit alarm AM3: Deviation high, low limit alarm
A-5 Humidity alarm value	AL H	9.0	-90.0 to 90.0 %RH
A-6 Lock	L o C	$\sigma F F$	OFF ON: Lock temperature/humidity parameter setting group ⁰²⁾
A-7 Parameter reset	i N I E	N o	NO: No reset YES: Reset all parameters

01) Alarm hysteresis = 1.0 °C/%RH (fixed)

02) When entering the parameter group, 'LOCK' indicator is ON.

Function: Alarm

■ Operation

• H: Alarm output hysteresis

Name	Alarm operation	Description
-	-	No alarm output
Deviation high limit		If deviation between PV and SV as high-limit is higher than set value of deviation temperature, the alarm output will be ON.
	High deviation: Set as 10°C High deviation: Set as -10°C	
Deviation low limit		If deviation between PV and SV as low limit is higher than set value of deviation temperature, the alarm output will be ON.
	Low deviation: Set as 10°C Low deviation: Set as -10°C	
Deviation high, low limit		If deviation between PV and SV as high/low-limit is higher than set value of deviation temperature, the alarm output will be ON.
	High, Low deviation: Set as 10°C	

Sold Separately: Terminal Protection Cover

• Unit: mm

RMA-COVER: DIN W72 × H72

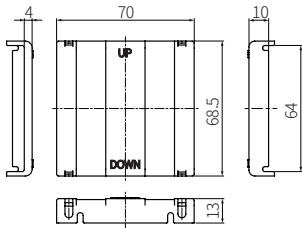

Segment Table

The segments displayed on the product indicate the following meanings. It may differ depending on the product.

7 Segment	11 Segment	12 Segment	16 Segment
0	0	0	0
1	1	1	1
2	2	2	2
3	3	3	3
4	4	4	4
5	5	5	5
6	6	6	6
7	7	7	7
8	8	8	8
9	9	9	9
A	A	A	A
b	b	b	b
c	c	c	c
d	d	d	d
E	E	E	E
F	F	F	F
G	G	G	G
H	H	H	H
I	I	I	I
J	J	J	J
K	K	K	K
L	L	L	L
M	M	M	M
N	N	N	N
O	O	O	O
P	P	P	P
Q	Q	Q	Q
R	R	R	R
S	S	S	S
T	T	T	T
U	U	U	U
V	V	V	V
W	W	W	W
X	X	X	X
Y	Y	Y	Y
Z	Z	Z	Z