

Multifunctional Signal/ Warning Lights with Built-in Sounder

STND100

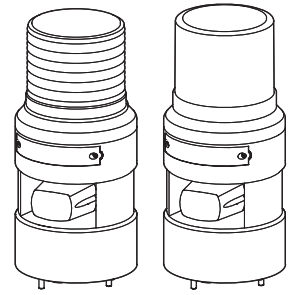

Thank you for purchasing Qlight's products. Please read this user manual carefully prior to installation and operation to ensure safe and correct use.

⚠ Precautions for Safety

Failure to follow the instructions below may cause a loss of life or serious physical injury.

1. During wiring or maintenance, please completely turn off the power of the product. (Failure to follow this may lead to an electric shock.)
2. Do not install the product in locations that subjects it to excessive dust or water other than the conditions designated by the IP protection ratings indicated for each product. (Failure to follow these instructions may cause a fire to the product, electric shock, physical injury, malfunction or damage to the product.)
3. Do not alter or repair this product. If maintenance or repair service is required, please contact your local Qlight contact point. (Failure to follow these instructions may lead to fire, electric shock, or product damage.)
4. Please apply the correct voltage to the product. (Failure to follow these instructions may lead to fire, electric shock, or product damage.)
5. When the product is applied to a condition that may impact lives or property, please make sure to have a double safety device. (Failure to follow this may cause damage to property, fire, electric shock and loss of life.)

⚠ Precautions for Correct Use

Failure to follow the proper instructions may cause damage to property, the product, and or malfunction of the product that would void the warranty.

1. Please remove any objects that can interrupt ventilation around the product.
2. Please turn off the power of the product immediately if it fails to operate properly.
3. Carefully wire the product according to each product's specification.
4. Please be careful in preventing chemicals such as thinner, benzene, etc. in contact with the surface of the product.
5. Do not apply excessive force/impact to the product.
6. Failure to follow any of the instructions above may cause malfunction or damage to the product, fire, and electric shock.

Ordering Specifications

STND100LR	-	24	-	R
[Model number]		[Voltage]		[Color]
• STND100LR		• 12-DC12V		R-Red
• STND100L		• 24-DC24V		A-Amber
• STND100R		• 12/24-DC12-24V(STND100L only)		G-Green
		• 110/220- AC110V-220V		B-Blue



Please scan the QR code for more detailed product information.

www.qlight.com

Product Specifications

Model number	Voltage	Current	Sound pattern and volume	Certificates	Weight	Color
STND100LR	DC12V	0.445A	Bit input : 5Ch Binary input : 30Ch Warning sound : Max. 105dB MP3 : Max. 98dB	CE	1.40Kg	R-Red A-Amber G-Green B-Blue
	DC24V	0.450A			1.62Kg	
	AC110V-220V	Max.0.170A			1.37Kg	
STND100L	DC12V-24V	Max.0.485A			1.78Kg	
	AC110V-220V	Max.0.190A				

Model number	Voltage	Current	Bulb specifications			Sound pattern and volume	Certificate	Weight	Color
			Volts/Watts	Configuration	Part#				
STND100R	DC12V	1.130A	12V10W	T16x35 15S	9	Bit input : 5Ch Binary input : 30Ch Warning sound : Max. 105dB MP3 : Max. 98dB	CE	1.57Kg	R-Red A-Amber G-Green B-Blue
	DC24V	0.865A	24V10W	T16x35 15S	10				
	AC110V -220V	Max. 0.350A	24V10W	T16x35 15S	10				
			24V10W	T16x35 15S	10				

※ CE compliant : DC24V

- Protection rating : IP54
- Ambient operating temperature : -20°C to +50°C (STND100LR, STND100R)
-30°C to +50°C (STND100L)

Dimensions

(Units : mm)

STND100LR/ STND100L/ STND100R

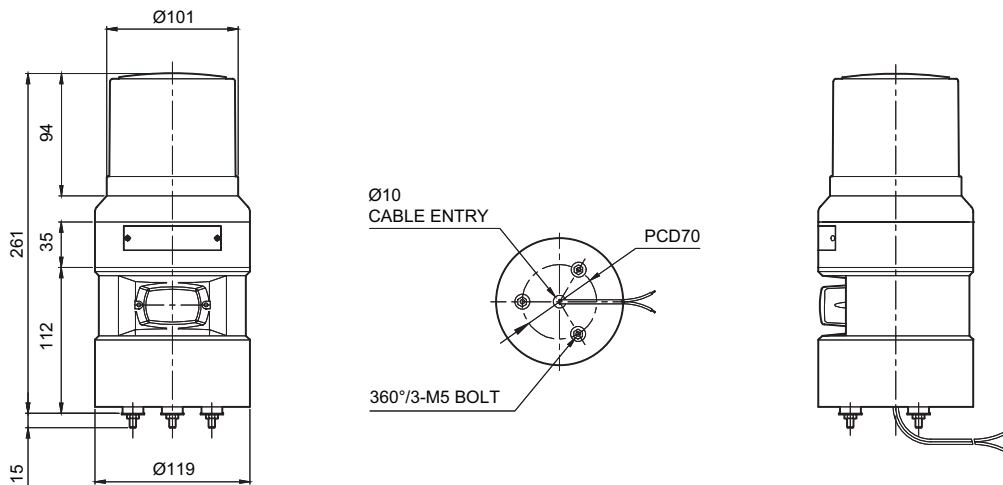

Wiring Instructions

STND100LR/ STND100L/ STND100R-DC/AC

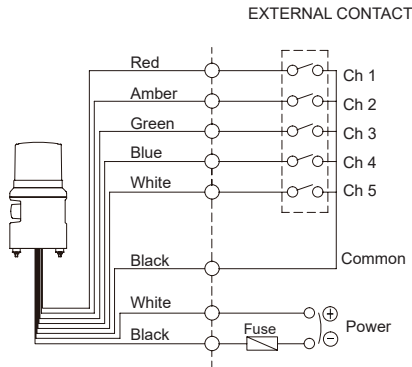

STND100L-DC/AC

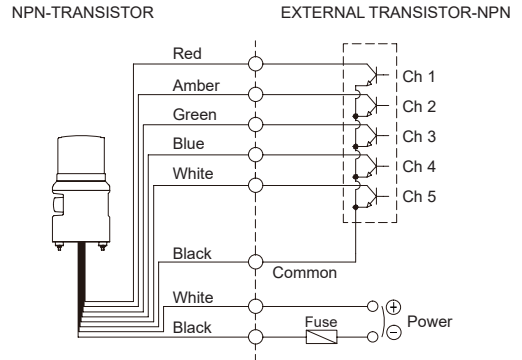

- External power line - UL1015 AWG18(0.75sq) x 2C 400mm
- External signal line - UL1007 AWG22(0.3sq) 400mm
- This product can be wired regardless of polarity.(STND100L only)

Bit/ Binary Input Method Depending on Wiring Method

■ Bit Input Mode

- Bit input mode(using external line) allows you to select one of five sound options by switching on one of the 5 channels (Ch1 - Ch5).
- Total of 5 sound options are configurable.

■ Binary Input Mode

- Binary input mode(using external line) allows you to receive multiple inputs by using the 5 channels (Ch1 - Ch5) to configure one of 30 sound options.
- Total of 30 sound options are configurable.

※ The channel selection method using a transistor is the same as the external contact method, please refer to the figure on the right.

※ The switch figure to the right explains how to wire the external contacts of a signal line product. If the product is not a signal line product, use the channel selection switch attached inside the product.

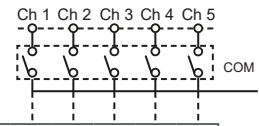

Bit Input Mode
Can select up to 5 sound options

Binary Input Mode
Can select up to 30 sound options

	Ch1	Ch2	Ch3	Ch4	Ch5
ON(1)	<input type="checkbox"/>	<input type="checkbox"/>	<input type="checkbox"/>	<input type="checkbox"/>	<input type="checkbox"/>
OFF(0)	<input checked="" type="checkbox"/>	<input checked="" type="checkbox"/>	<input checked="" type="checkbox"/>	<input checked="" type="checkbox"/>	<input checked="" type="checkbox"/>
No.	1	2	3	4	5
0	0	0	0	0	0
1	1	0	0	0	0
2	0	1	0	0	0
3	0	0	1	0	0
4	0	0	0	1	0
5	0	0	0	0	1
6	0	0	0	0	0
7	0	0	0	0	1
8	0	0	0	1	0
9	0	0	0	1	1
10	0	0	1	0	0
11	0	0	1	0	1
12	0	0	1	1	0
13	0	0	1	1	1
14	0	1	0	0	0
15	0	1	0	0	1
16	0	1	0	1	0
17	0	1	0	1	1
18	0	1	1	0	0
19	0	1	1	0	1
20	0	1	1	1	0
21	0	1	1	1	1
22	1	0	0	0	0
23	1	0	0	0	1
24	1	0	0	1	0
25	1	0	0	1	1
26	1	0	1	0	0
27	1	0	1	0	1
28	1	0	1	1	0
29	1	1	1	0	1
30	1	1	1	1	0

Parts Definition/ Installation

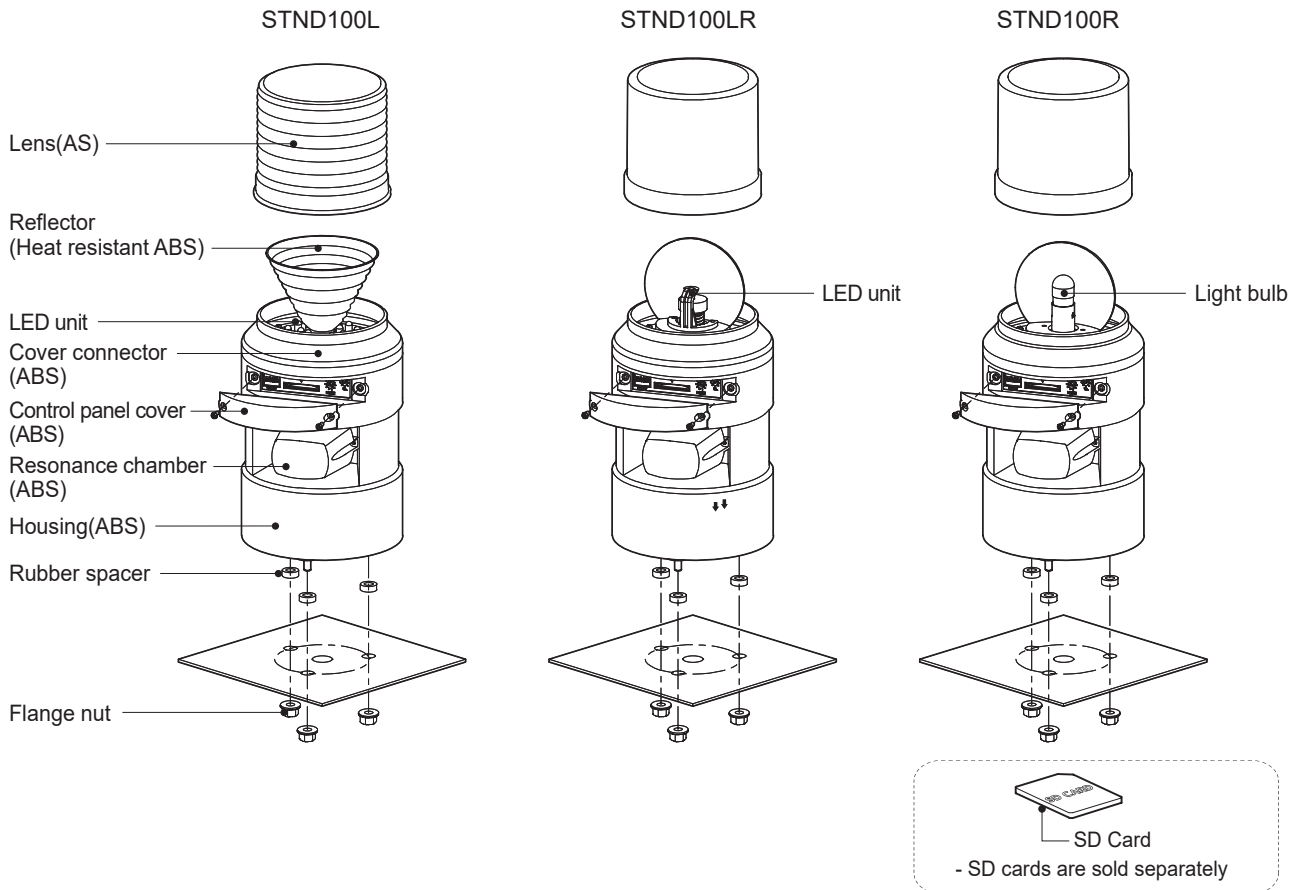

- First, remove the flange nuts from bolts and place the product through the mounting surface holes.
- Fasten the flange nuts on the opposite side of the mounting surface until the product is tightened securely.

Mounting Hole Specifications

- Machine holes on the mounting surface referring to the diagram on the right.

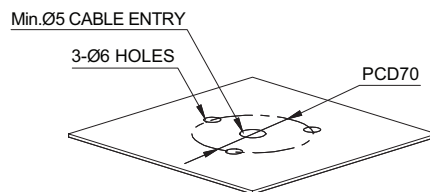

STND100LR/ STND100L/ STND100R

Installation Environment and Protection Rating

- This product is designed for use with protection rating of IP54.
- If the product is installed in locations that subject it to excessive dust or water other than the designated IP protection rating indicated(IP54), it may cause malfunction or damage to the product.
- In case of outdoor applications, install the product in the upright or horizontal position. Do not install the product upside-down or in positions where water can potentially penetrate into the product and impact its operation.
- For further information, please visit our website(www.qlight.com).

Front Cover Removal Instructions

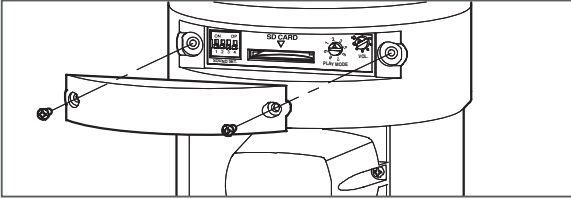

- To access the control panel, remove the front cover by unscrewing the M3 bolts on the front cover.

Front Control Configuration

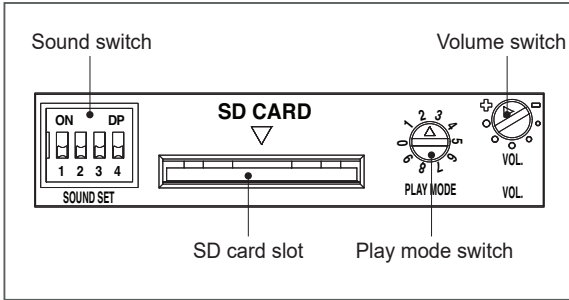

Sound Setting

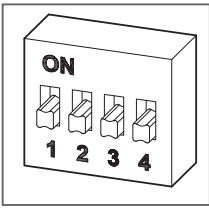

- Select different built-in sounds using the sound setting switch.
- Please be conscious of the number selected for your desired sound option.
 - Switch 1 : Can select between built-in sound and external sound options
 - Switch 2, 3 and 4 : Can select sound group from built-in sounds

Select Built-in Voice Group

- This is used when built-in sound mode is selected.
- Select between the six sound groups.
- Every group has 5 type of sounds.

How to select binary type sound group				
No.	ON(1)	OFF(0)	OFF(0)	Sounds
	2	3	4	
1	0	0	1	5 Warning Sounds
2	0	1	0	5 Special Warning Sounds (1st Group)
3	0	1	1	5 Melodies
4	1	0	0	5 Alarms
5	1	0	1	5 Special Warning Sounds (2nd Group)
6	1	1	0	5 Special Warning Sounds (3rd Group)

Selection between Built-in Sound and External Sound (SD Card Type)

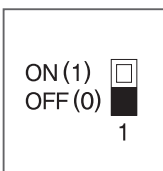

- To play built-in sounds, set the sound setting switch to the OFF (0) position.
- To play an external sound on the SD card, insert the SD card into SD card slot and set the sound setting switch to ON (1).

Play Mode Setting

- Can select between channel input methods (bit/ binary) and various playback modes.
- Use a (-) flat screwdriver to rotate one space at a time. (regardless of the direction of rotation.)
- Switch 0 and 9 have no function.

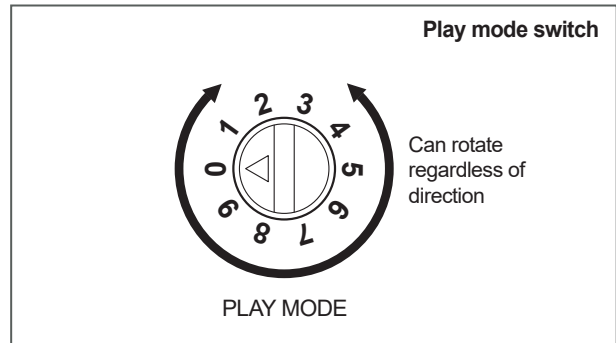

PLAY MODE		
1	Bit Input Mode	<ul style="list-style-type: none"> • Play back one of the 5 built-in or external sounds once • For a built-in sound, the playback time is about 10 seconds
2	Binary Input Mode	<ul style="list-style-type: none"> • Play back one of the 30 built-in or external sounds once • For a built-in sound, the playback time is about 10 seconds
3	Bit Input Hold Playback Mode	<ul style="list-style-type: none"> • Play back one of the 5 built-in or external sounds continuously
4	Binary Input Hold Playback Mode	<ul style="list-style-type: none"> • Play back one of the 30 built-in or external sounds continuously
5	Bit Input Sound Reduction Mode	<ul style="list-style-type: none"> • Decrease the volume of the selected channel by 15dB • Play back one of the 5 built-in or external sounds continuously
6	Binary Input Sound Reduction Mode	<ul style="list-style-type: none"> • Decrease the volume of the selected channel by 15dB • Play back one of the 30 built-in or external sounds continuously
7	Bit Input Sequence Memory Playback Mode	<ul style="list-style-type: none"> • When other channel signals are continuously inputted within 3 seconds after inputting the channel, the input order is memorized and playback in the memorized order (playback time is 3 - 5 seconds) • The last input channel is played continuously (Bit input only)
8	Test Mode	<ul style="list-style-type: none"> • In the test mode, the Ch1 of the built-in sound or the external sound is automatically played continuously • Switch back to another mode to exit test mode

Volume Adjustment

- The volume output of this product is adjustable.
- Turn the volume dial clockwise to increase the volume, and turn counter clockwise to decrease the volume.
- There will be no sound when the dial is put at MIN.

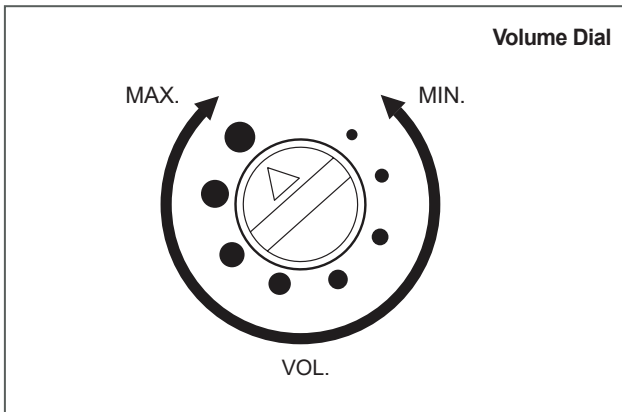



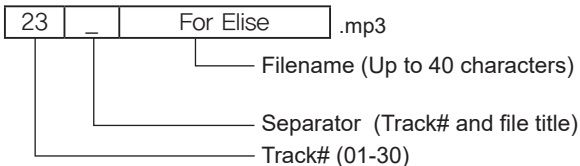

SD Card Specifications and Sound Saving Manual

- SD card specifications
 - Use standard SD card.
 - Mini SD or Micro SD also can be used with adaptor.
 - SD, SDHC type supported
 - Storage capacity : Max. 32GB
 - Class : No specification
- Please save the MP3 sound file on the SD card as shown below.
- Create an "MP3_FILE" folder on the SD card and save the MP3 file in the following file format.
- MP3 file format



- When saving files, please save them in order.
- Please start saving after formatting the SD card.
- The length of the file name must not exceed 40 characters.

[Example]

-  01_Fire.mp3
-  02_Emergency.mp3
-  03_For Elise.mp3
- ⋮
-  30_Cuckoo's Waltz.mp3

Sound Type and Combination Manual

■ Bit input - Playing Built-in Sound

- In bit input mode, you can choose one sound from 30 sounds by configuring the 5 channels.
- For sound configurations, refer to the table below.

Bit input method sound configuration						Type of sound (WS group as an example)
ON(1) OFF(0)	Ch1	Ch2	Ch3	Ch4	Ch5	
No.	1	2	3	4	5	
0	0	0	0	0	0	No sound
1	1	0	0	0	0	Fire.A-ANG(560Hz-1.5kHz)
2	0	1	0	0	0	Emergency WA-U (600Hz-1.5kHz)
3	0	0	1	0	0	Ambulance PI-PO (450Hz-900Hz)
4	0	0	0	1	0	Machinery Fault(820Hz)
5	0	0	0	0	1	High Expansion(1kHz)

※ Please be noted that the configuration chart above is explaining how to wire terminal blocks. The actual product does not have a switch.

■ Sound Type by Group

Bit input method sound configuration			
Group	Channel	Type of sound	
WS	5 Warning Sounds	Ch1	Fire.A-ANG (560Hz-1.5kHz)
		Ch2	Emergency WA-U (600Hz-1.5kHz)
		Ch3	Ambulance PI-PO (450Hz-900Hz)
		Ch4	Machinery Fault (820Hz)
		Ch5	High Expansion (1kHz)
WP	5 Special Warning Sounds (1st Group)	Ch1	Fire.A-ANG (560Hz-1.5kHz)
		Ch2	Abandon Alarm (820Hz)
		Ch3	Machinery Fault (820Hz)
		Ch4	High Expansion (1kHz)
		Ch5	7 Short PI. / 1 Long (1kHz)
WM	5 Melodies	Ch1	Sweet Home
		Ch2	For Elise
		Ch3	Cuckoo's Waltz
		Ch4	Piano Sonata
		Ch5	Turkish March
WA	5 Alarms	Ch1	Beep Intermittent
		Ch2	Door Chime
		Ch3	Phone Ring
		Ch4	PI.PI.PI Short
		Ch5	Tripping Beat
WO	5 Special Warning Sounds (2nd Group)	Ch1	Rel rel rel (730Hz-920Hz)
		Ch2	Slow Ambulance PI-PO (820Hz-1.05kHz)
		Ch3	Wye yong Wye yong (770Hz-1.2kHz)
		Ch4	Phone ring 2 (740Hz-910Hz)
		Ch5	Fire.A-ANG (770Hz-1.11kHz)
WN	5 Special Warning Sounds (3rd Group)	Ch1	Oit Oit (500Hz-1.11kHz)
		Ch2	Pi o Pi o (940Hz-2.19kHz)
		Ch3	Slow Di o Di o (680Hz-840Hz)
		Ch4	Li long Li ling (420Hz-470Hz)
		Ch5	911 Siren (150Hz-1kHz)

■ Binary Input - Playing Built-in Sound

- In binary input mode, you can choose one sound from 30 sounds by configuring the 5 channels.
- For sound configurations, refer to the table below.
- Please be aware that the configuration for sound using the binary input method is different from the bit input method.

Binary input method sound configuration						
No.	Ch1	Ch2	Ch3	Ch4	Ch5	Type of sound
	ON(1) OFF(0)	ON(1) OFF(0)	ON(1) OFF(0)	ON(1) OFF(0)	ON(1) OFF(0)	
0	0	0	0	0	0	No sound
1	0	0	0	0	1	Fire.A-ANG (560Hz-1.5kHz)
2	0	0	0	1	0	Emergency WA-U (600Hz-1.5kHz)
3	0	0	0	1	1	Ambulance PI-PO (450Hz-900Hz)
4	0	0	1	0	0	PI-ik PI-ik (800Hz)
5	0	0	1	0	1	Machinery Fault (820Hz)
6	0	0	1	1	0	High Expansion (1kHz)
7	0	0	1	1	1	Alarm (1kHz)
8	0	1	0	0	0	Sweet Home
9	0	1	0	0	1	For Elise
10	0	1	0	1	0	Cuckoo's Waltz
11	0	1	0	1	1	Piano Sonata
12	0	1	1	0	0	Turkish March
13	0	1	1	0	1	Magic Flute
14	0	1	1	1	0	Badinerie
15	0	1	1	1	1	Pineapple Rag
16	1	0	0	0	0	Beep Intermittent
17	1	0	0	0	1	Door Chime
18	1	0	0	1	0	Phone Ring
19	1	0	0	1	1	PI.PI.PI Short
20	1	0	1	0	0	Tripping Beat
21	1	0	1	0	1	Rel rel rel (730Hz-920Hz)
22	1	0	1	1	0	Slow Ambulance PI-PO (820Hz-1.05kHz)
23	1	0	1	1	1	Wye yong Wye yong (770Hz-1.2kHz)
24	1	1	0	0	0	Phone ring 2 (740Hz-910Hz)
25	1	1	0	0	1	Fire.A-ANG (770Hz-1.11kHz)
26	1	1	0	1	0	Oit Oit (500Hz-1.11kHz)
27	1	1	0	1	1	Pi o Pi o (940Hz-2.19kHz)
28	1	1	1	0	0	Slow Di o Di o (680Hz-840Hz)
29	1	1	1	0	1	Li long Li ling (420Hz-470Hz)
30	1	1	1	1	0	911 Siren (150Hz-1kHz)

※ Please be noted that the configuration chart above is explaining how to wire terminal blocks. The actual product does not have a switch.

Sound Type and Combination

■ Bit Input - Playing External Sound (SD Card)

- User can save sounds(MP3) to the SD card and able to select 1 sounds from 5 saved sounds.
- For sound configurations, refer to the table below.

Bit input method sound source configuration						
No.	Ch1	Ch2	Ch3	Ch4	Ch5	Type of sound
	ON(1) OFF(0)	ON(1) OFF(0)	ON(1) OFF(0)	ON(1) OFF(0)	ON(1) OFF(0)	
0	0	0	0	0	0	No sound
1	1	0	0	0	0	Custom sound 1(01_xxx.mp3)
2	0	1	0	0	0	Custom sound2(02_xxx.mp3)
3	0	0	1	0	0	Custom sound3(03_xxx.mp3)
4	0	0	0	1	0	Custom sound4(04_xxx.mp3)
5	0	0	0	0	1	Custom sound5(05_xxx.mp3)

※ Please be noted that the configuration chart above is explaining how to wire terminal blocks. The actual product does not have a switch.

■ Binary Input - Playing External Sound (SD Card)

- Binary input mode chooses one of the 30 sounds by combining the on/ off switch of the 5 different channels to the associated tone.
- For sound configurations, refer to the table below.
- Please be aware that the configuration for sound using the binary input method is different from the bit input method.

Binary input method sound source configuration						
No.	Ch1	Ch2	Ch3	Ch4	Ch5	Type of sound
	ON(1) OFF(0)	ON(1) OFF(0)	ON(1) OFF(0)	ON(1) OFF(0)	ON(1) OFF(0)	
0	0	0	0	0	0	No sound
1	0	0	0	0	1	Custom sound1(01_xxx.mp3)
2	0	0	0	1	0	Custom sound2(02_xxx.mp3)
3	0	0	0	1	1	Custom sound3(03_xxx.mp3)
4	0	0	1	0	0	Custom sound4(04_xxx.mp3)
5	0	0	1	0	1	Custom sound5(05_xxx.mp3)
6	0	0	1	1	0	Custom sound6(06_xxx.mp3)
7	0	0	1	1	1	Custom sound7(07_xxx.mp3)
8	0	1	0	0	0	Custom sound8(08_xxx.mp3)
9	0	1	0	0	1	Custom sound9(09_xxx.mp3)
10	0	1	0	1	0	Custom sound10(10_xxx.mp3)
11	0	1	0	1	1	Custom sound11(11_xxx.mp3)
12	0	1	1	0	0	Custom sound12(12_xxx.mp3)
13	0	1	1	0	1	Custom sound13(13_xxx.mp3)
14	0	1	1	1	0	Custom sound14(14_xxx.mp3)
15	0	1	1	1	1	Custom sound15(15_xxx.mp3)
16	1	0	0	0	0	Custom sound16(16_xxx.mp3)
17	1	0	0	0	1	Custom sound17(17_xxx.mp3)
18	1	0	0	1	0	Custom sound18(18_xxx.mp3)
19	1	0	0	1	1	Custom sound19(19_xxx.mp3)
20	1	0	1	0	0	Custom sound20(20_xxx.mp3)
21	1	0	1	0	1	Custom sound21(21_xxx.mp3)
22	1	0	1	1	0	Custom sound22(22_xxx.mp3)
23	1	0	1	1	1	Custom sound23(23_xxx.mp3)
24	1	1	0	0	0	Custom sound24(24_xxx.mp3)
25	1	1	0	0	1	Custom sound25(25_xxx.mp3)
26	1	1	0	1	0	Custom sound26(26_xxx.mp3)
27	1	1	0	1	1	Custom sound27(27_xxx.mp3)
28	1	1	1	0	0	Custom sound28(28_xxx.mp3)
29	1	1	1	0	1	Custom sound29(29_xxx.mp3)
30	1	1	1	1	0	Custom sound30(30_xxx.mp3)

※ Please be noted that the configuration chart above is explaining how to wire terminal blocks. The actual product does not have a switch.

Operation Method and Setting

When using a built-in sound		When using an external sound (SD card)	
Bit input	Binary input	Bit input	Binary input
Organized into 6 groups of 5 sound tones for a total of 30 sound tone options. Play one of the five sounds in each 5 group	Play one of 30 built-in sounds	Play one of the 5 user-recorded sounds	Play one of the 5 user-recorded sounds

■ When Using a Built-in Sound in Bit Input Mode

※ Sound switch setting → Play mode switch setting → Channel selection

- Set the No. 1 switch of the Sound setting switch to OFF to select built-in sound.
 - For more information, see page 5 'Sound Settings'.
- Use one of the sound setting switches 2, 3 and 4 to select one of the 6 groups.
 - For more information, see page 5 'Sound Settings'.
- Use the play mode setting switch to select one of the modes between 1, 3, 5, 7, or 8.
 - Mode 8 is a test mode which continuously plays channel 1. (In this case, channel selection is disabled.)
 - For more information, refer to page 5 'Play Mode Setting'.
- Use the sound select switch to select one of the five built-in sounds.
 - For more information, please refer to page 6 'Bit input - Playing Built-in Sound'.
 - For external signal line type (LC) products, please refer to page 3 'Bit/ Binary Input Method Depending on Wiring Method'.

■ When Using a Built-in Sound in Binary Input Mode

※ Sound switch setting → Play mode switch setting → Channel selection

- Set the No. 1 switch of the sound setting switch to OFF to select the built-in sound.
 - For more information, see page 5 'Sound Settings'.
- Use one of the sound setting switches 2, 3 and 4 to select one of the 6 groups.
 - For more information, see page 5 'Sound Settings'.
- Use the play mode setting switch to select one of the modes between 2, 4, 6, or 8.
 - Mode 8 is a test mode which continuously plays channel 1. (In this case, channel selection is disabled.)
 - For more information, refer to page 5 'Play Mode Setting'.
- Use the sound select switch to select one of the 30 built-in sounds.
 - For more information, please refer to page 7 'Binary Input - Playing Built-in Sound'.
 - For external signal line type (LC) products, please refer to page 3 'Bit/ Binary Input Method Depending on Wiring Method'.

■ When Using an External Sound Source (SD Card) in Bit Input Mode

※ Insert SD card → Sound switch setting → Play mode switch setting → Channel selection

- Please refer to page 6 'SD Card Specifications and Sound Saving Manual' to see how to save sound files.
 - Supports up to 5 user-defined sounds
- Insert the SD card into the SD card slot.
- Set the No. 1 switch of the sound switch to ON to select external sound.
 - For more information, see page 5 'Sound Settings'.
- Use the play mode setting switch to select 1, 3, 5, 7 or 8 mode.
 - Mode 8 is a test mode which continuously plays channel 1. (In this case, channel selection is disabled.)
 - For more information, refer to page 5 'Play Mode Setting'.
- To select a channel, use the terminal block in the back side of the product to select one of the 5 user-defined sounds.
 - For more information, please refer to page 8 'Bit Input - Playing External Sound (SD Card)'.
 - For external signal line type (LC) products, please refer to page 3 'Bit/ Binary Input Method Depending on Wiring Method'.

■ When Using an External Sound Source (SD Card) Source in Binary Input Mode

※ Insert SD card → Sound switch setting → Play mode switch setting → Channel selection

- Please refer to page 6 'SD Card Specifications and Sound Saving Manual' to see how to save sound files.
 - Supports up to 30 user-defined sounds
- Insert the SD card into the SD card slot.
- Set the No. 1 switch of the sound setting switch to ON to select external sound.
- Use the play mode setting switch to select one of the modes between 2, 4, 6, or 8.
 - Mode 8 is a test mode which continuously plays channel 1. (In this case, channel selection is disabled.)
 - For more information, refer to page 5 'Play Mode Setting'.
- Use the sound select switch to select the one of the 30 user-defined sounds.
 - For more information, please refer to page 8 'Binary Input - Playing External Sound (SD Card)'.
 - For external signal line type (LC) products, please refer to page 3 'Bit/ Binary Input Method Depending on Wiring Method'.

Technical Certification

- Qlight products are designed to meet strict quality and technical standards. Thus, the Qlight brand is widely recognized for its high quality and technical innovations from leading institutions around the world.



ISO International Organization for Standardization

Qlight quality assurance systems have been certified by ISO by applying the ISO 9001:2008, KS Q ISO 9001:2009 regulation.



IECEX International Explosion Proof Certification (IECEX)

Certified that Qlight's products are being manufactured and manage according to international standards.



ATEX The European Regulatory Framework or Manufacture, Installation and Use of Equipment in Explosive Atmospheres

Qlight's explosion proof products comply with ATEX Directives 94/9/EC.



NEPSI National Supervision and Inspection Center for Explosion Protection and Safety of Instrumentation

Qlight's design and manufacturing system meets the People's Republic of China National explosion proof Standard. (Chinese Standard-GB3836/GB12476)



KCs Explosion Proof Device Safety Certification System

The safety performance of machines and equipment subject to safety certification and Technical capability and production system have been certified safety certification standards.



TIIS Japan Explosion-proof Certification

TIIS is a Japanese explosion proof test and certification system accordance with the Ministry of Health, Labour and Welfare Notice and the explosion proof guidelines for factory electrical equipment. Qlight's explosion proof products have been tested and certified by TIIS.



CCS China Classification Society

Qlight's design and quality assurance system has been certified by the China Classification Society.



RMRS Russian Maritime Register of Shipping

Qlight's design and quality assurance system has been certified from Russian Maritime Register of Shipping.



LR Lloyd's Register

Qlight's design and quality assurance system has been certified from Lloyd's Register.



KR Korean Register of Shipping

Qlight's design and quality assurance system has been certified by the Korean Register of Shipping.



KC Korea Safety Certification

Qlight's products are certified by KC for preventing accident caused by fire.



E-mark Commission Directive Regarding Vehicle Industry

Qlight has obtained EU mark for approved vehicles and vehicle components sold into the EU (EEA : European Economic Area)



ICAO International Civil Aviation Organization

Qlight guarantees our products satisfy the criteria regulated by the International Civil Aviation Organization (ICAO, FAA).



KCC Conformity Assessment of Broadcasting Communication Equipment

Qlight has been certified to protect the electromagnetic environment that causes unwanted electromagnetic waves from the device, communication failure due to other devices or external radio waves, and malfunction of the device.



UL Underwriters Laboratories

Qlight's design and quality assurance system has been certified from UL to ensure the stability of consumption goods and to protect consumers.



CCCF China Certification Center for Security & Protection

Qlight has passed the rigorous examination process of "Passing Fire Protection Products Centering" in order to sell fire-fighting products such as fire alarm equipment to Chinese market.



CCC China Compulsory Certificate

Qlight's has obtained CCC which guarantees safety, protection against fraud, environment, etc.



CE European Commission

Qlight has been certified by the European Commission.



RoHS2 Restriction of Hazardous Substances Directive

Qlight complies with the Restriction of Hazardous Substances Directive by limiting its use of hazardous materials.

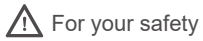

For your safety

Specification and dimensions listed in this catalogue subject to change without notice for product quality improvement.
The newest product information is available on our website.(www.qlight.com)
Please read the instruction manual attached to the product carefully before installation and use.

Qlight Co., Ltd. www.qlight.com | trade@qlight.com

Head Office | Suite #1510, STX-V Tower, 128 Gasan digital 1-ro, Geumcheon-gu, Seoul, Korea

Tel. +82-2-2679-6152(Toll free. +82-80-328-2222) Fax. +82-2-2679-6154

Factory | 185-25, Mukbang-ro, Sangdong-myeon, Gimhae-si, Gyeongsangnamdo, Korea Tel. +82-55-328-1111(Toll free. +82-80-328-1111)

Qlight OverSEAs Sales Dept | 704 Nakdong-daero, Sasang-gu, Busan, Korea(Eomgung-Dong) Tel : +82-51-620-4100

Qlight Public Relations & Marketing Team Office | 704 Nakdong-daero, Sasang-gu, Busan, Korea(Eomgung-Dong) Tel. +82-51-245-0017

Qlight USA, Inc. www.qlight.com www.qlightusa.com | sales@qlightusa.com

3003 North First Street, Suite #341, San Jose, CA 95134 USA Tel. +1-408-519-5740 Fax. +1-408-519-5739

SHANGHAI Qlight Electronic Co., Ltd. www.qlight.com www.qlightcn.com | qlightcn@qlight.com

China Factory/ Shanghai Sales Office | #19, Nanda Road, Baoshan Area, Shanghai, China Tel. +86-21-6651-7100 Fax. +86-21-6315-3929

China Factory Site 2 (Qidong) | #33, Haiyan Road, Qidong High-tech Industrial Development Zone, Qidong, Jiangsu Province, China

Tel +86-513-8384-9999 Fax +86-513-8384-9910

Qlightec

Innovation in Alarm & Signal

Product Operation Inquiry / Customer Support +82-51-620-4100

You can expect prompt service if you have exact information such as model name, symptom, telephone number and address.

※ ALL PRODUCT, PRODUCT SPECIFICATIONS AND DATA ARE SUBJECT TO CHANGE WITHOUT NOTICE TO IMPROVE RELIABILITY, FUNCTION OR DESIGN OR OTHERWISE.

Head office : Suite #1510, STX-V Tower, 128 Gasan digital 1-ro, Geumcheon-gu, Seoul, Korea (Postal Code : 08507)

Factory : 185-25, Mukbang-Ro, Sangdong-Myeon, Gimhae-Si, Gyeongsangnam-Do, Korea (Postal Code : 50805)

www.qlight.com

EN - STND100L - 2106A