



NC7 Series AC Contactor 09~620A

1. General

The NC7 series AC contactor (hereinafter referred to as "contactor") is mainly used in the circuit with an alternating current of 50Hz (or 60Hz), rated operational voltage up to 690V, and rated operational current up to 620A under the usage category of AC-3/400V; this contactor is mainly used for remotely closing and breaking circuits, and can be combined with an appropriate thermal overload relay to form an electromagnetic starter so as to protect the circuits likely to be overloaded in operation; the contactor is well suited for frequently starting and controlling AC motors.

Standard: IEC60947-4-1

2. Operating conditions

2.1 Ambient air temperature: $-5^{\circ}\text{C} \sim +40^{\circ}\text{C}$, its mean value not greater than $+35^{\circ}\text{C}$ within 24 hours.

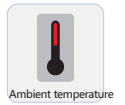

2.2 Atmospheric conditions:
When the maximum temperature is $+40^{\circ}\text{C}$, the relative humidity of the air shall not be higher than 50%; a higher relative humidity is allowed at a lower temperature, e.g., up to 90% at 20°C . Special measures shall be taken for the condensation occasionally produced due to temperature change.



2.3 Altitude: not higher than 2000m.

2.4 Pollution grade: 3



2.5 Installation classification: III

2.6 Installation condition:
the installing surface shall be inclined at not greater than $\pm 5^{\circ}$ to the vertical.

2.7 Impact vibration:
The product shall be installed in the place free of remarkable shake, impact and vibration.

D

3. Type and meaning

3.1 Product type and meaning

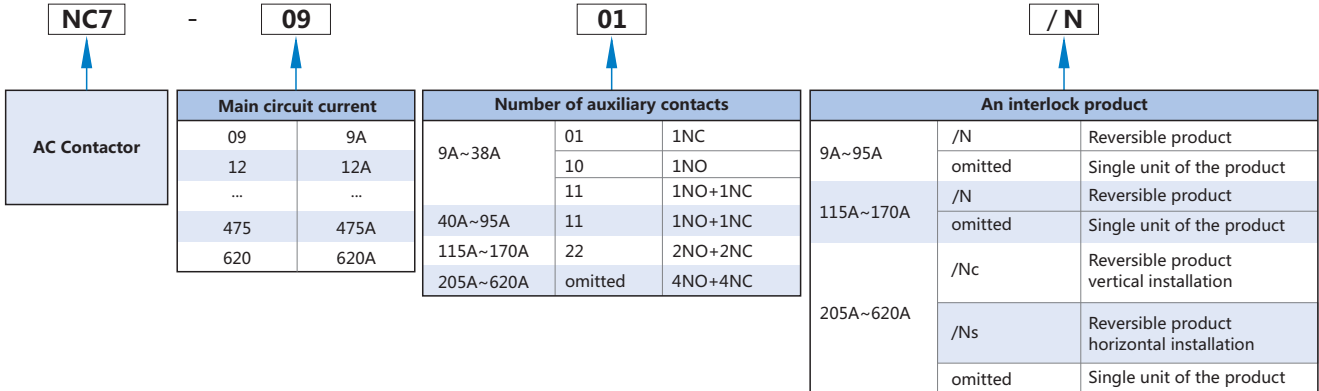



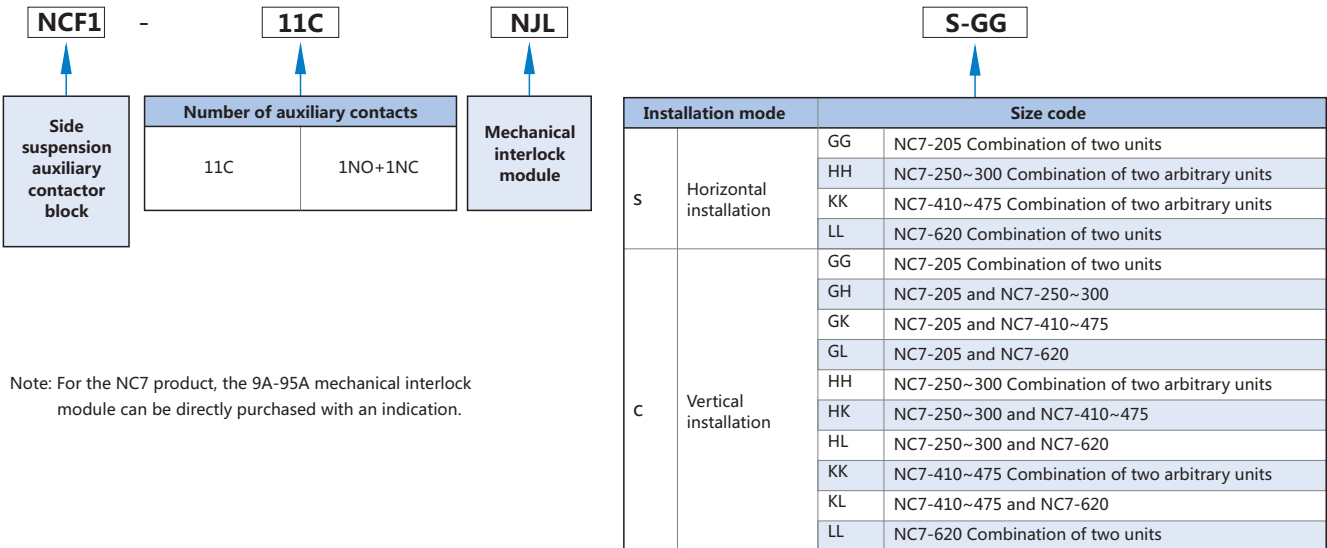
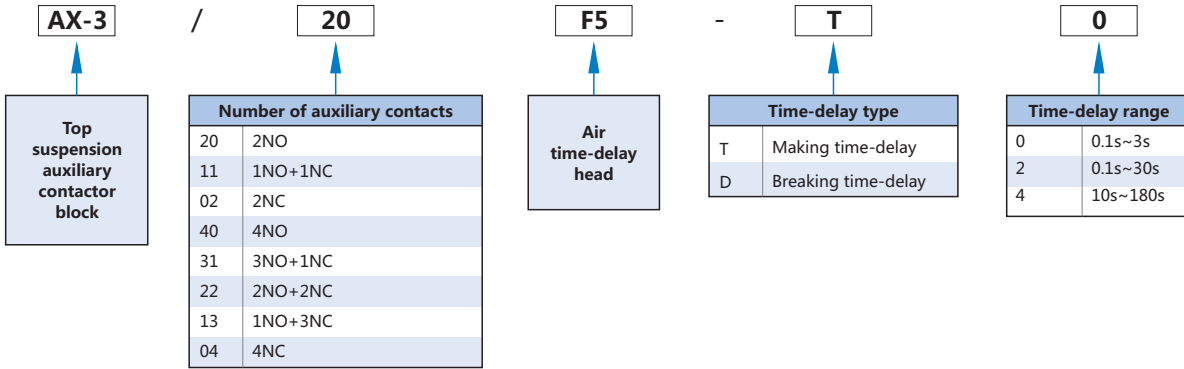

3.2 Accessory type and meaning



Note: For the NC7 product, the 9A-95A mechanical interlock module can be directly purchased with an indication.





4. Quick selection table

Specified current		9A		12A		18A		22A		25A		32A		38A	
															
Number of the auxiliary contacts provided with the body itself	1 NO auxiliary contact	NC7-0910		NC7-1210		NC7-1810				NC7-2510		NC7-3210		NC7-3810	
	1 NC auxiliary contact	NC7-0901		NC7-1201		NC7-1801				NC7-2501		NC7-3201		NC7-3801	
	1 NO+1NC auxiliary contact	NC7-0911		NC7-1211		NC7-1811		NC7-2211		NC7-2511		NC7-3211		NC7-3811	
IEC/EN 60974-4-1		kW A		kW A		kW A		kW A		kW A		kW A		kW A	
Appointed free air heat generation current (A)		20		20		32		32		40		50		50	
Rated operational current and power	380V/400V(AC-3)	4	9	5.5	12	7.5	18	11	22	11	25	15	32	18.5	38
	380V/400V(AC-4)	1.5	3.5	2.2	5	3	7.7	3	7.7	4	8.5	5.5	12	5.5	12
	660V/690V(AC-3)	5.5	6.6	7.5	8.9	10	12	11	14	15	18	18.5	22	18.5	22
	660V/690V(AC-4)	1.1	1.5	1.5	2	3.7	3.8	3.7	3.8	4	4.4	5.5	7.5	5.5	7.5

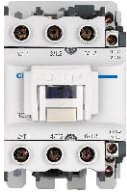

Accessories which can be further attached

			
Side suspension auxiliary contact	Top suspension auxiliary contact	Air delay head	Mechanical interlock module
			
Surge suppressor	Thermal overload relay	Electronic overload relay	

Specified current		40A		50A		65A		80A		95A	
											
Number of the auxiliary contacts provided with the body itself	1NO+1NC auxiliary contact	NC7-4011		NC7-5011		NC7-6511		NC7-8011		NC7-9511	
IEC/EN 60974-4-1		kW A		kW A		kW A		kW A		kW A	
Appointed free air heat generation current (A)		60		80		80		110		110	
Rated operational current and power	380V/400V(AC-3)	18.5	40	22	50	30	65	37	80	45	95
	380V/400V(AC-4)	7.5	18.5	11	24	15	28	18.5	37	22	44
	660V/690V(AC-3)	30	34	37	39	37	42	45	49	45	49
	660V/690V(AC-4)	7.5	9	11	12	11	14	15	17.3	18.5	21.3

Accessories which can be further attached



Side suspension auxiliary contact



Top suspension auxiliary contact



Air delay head



Mechanical interlock module



Surge suppressor



Thermal overload relay



Electronic overload relay

Specified current		115A		150A		170A	
							
Number of the auxiliary contacts provided with the body itself		NC7-115		NC7-150		NC7-170	
IEC/EN 60974-4-1		kW A		kW A		kW A	
Appointed free air heat generation current (A)		200		200		275	
Rated operational current and power	380V/400V(AC-3)	55	115	75	150	90	170
	380V/400V(AC-4)	55	115	75	150	90	150
	660V/690V(AC-3)	80	86	100	107	110	118
	660V/690V(AC-4)	80	86	100	107	110	107

Accessories which can be further attached



Top suspension auxiliary contact



Air delay head



Side suspension auxiliary contact



Thermal overload relay



Electronic overload relay



Mechanical interlock module

Specified current		205A		250A		300A	
							
without auxiliary contacts, can mount two Top suspension auxiliary contacts	mount two AX-3/22 4NO+4NC	NC7-205		NC7-250		NC7-300	
	Other mode	Note		Note		Note	
IEC/EN 60974-4-1		kW	A	kW	A	kW	A
Appointed free air heat generation current (A)			275		315		380
Rated operational current and power	380V/400V(AC-3)	110	205	132	250	160	300
	380V/400V(AC-4)	110	205	132	250	160	300
	660V/690V(AC-3)	129	137	160	170	220	235
	660V/690V(AC-4)	129	137	160	170	220	235

Accessories which can be further attached



Top suspension auxiliary contact



Air delay head





Mechanical interlock module



Thermal overload relay



Electronic overload relay

Specified current		410A	475A	620A			
							
without auxiliary contacts, can mount two Top suspension auxiliary contacts	mount two AX-3/22	NC7-410	NC7-475	NC7-620			
	4NO+4NC	Note	Note	Note			
IEC/EN 60974-4-1		kW	A	kW	A		
Appointed free air heat generation current (A)			450		630		800
Rated operational current and power	380V/400V(AC-3)	200	410	265	475	335	620
	380V/400V(AC-4)	200	410	265	475	335	620
	660V/690V(AC-3)	280	303	335	353	450	462
	660V/690V(AC-4)	280	303	335	353	450	462

Accessories which can be further attached



Top suspension auxiliary contact



Air delay head



Mechanical interlock module







Thermal overload relay



Electronic overload relay

Modularized accessories which can be installed additionally

 <p>AX-3 Auxiliary contact</p>	Number of auxiliary contacts	4NO	AX-3/40	Able to be used for the whole series products
		3NO+1NC	AX-3/31	
		2NO+2NC	AX-3/22	
		1NO+3NC	AX-3/13	
		4NC	AX-3/04	
		2NO	AX-3/20	
		1NO+1NC	AX-3/11	
		2NC	AX-3/02	
 <p>F5 1N/O+1N/C Air delay head</p>	On-delay time (s)	0.1~3	F5-T0	Able to be used for the whole series products
		0.1~30	F5-T2	
		10~180	F5-T4	
	Off-delay time (s)	0.1~3	F5-D0	
		0.1~30	F5-D2	
		10~180	F5-D4	
 <p>NCF1-11C Secondary side suspension auxiliary contact</p>	Number of auxiliary contacts	1NO+1NC	NCF1-11C	Able to be used for the products of 170A or lower
 <p>SR2-A Surge suppressor</p>	Suppression voltage range	AC 24V~48V	SR2 24V~48V	Able to be used for the products of 9A~38A or lower
		AC 100V~250V	SR2 100V~250V	
		AC 380V~440V	SR2 380V~440V	
 <p>SR2-B Surge suppressor</p>		AC 100V~127V	SR2-B 100V~127V	Able to be used for the products of 40A~95A or lower
		AC 200V~250V	SR2-B 200V~250V	
		AC 380V~440V	SR2-B 380V~440V	

 <p>NR2 Thermal overload relay</p>		NR2-25	9A~32A	
		NR2-36	32A, 38A	
		NR2-93	40A~95A	
		NR2-150	115A~150A	
		NR2-200	115A~170A	
		NR2-630	205A~620A	
 <p>NRE8 Electronic overload relay</p>		NRE8-25	9A~32A	
		NRE8-40	40A	
		NRE8-100	40A~95A	
		NRE8-200	115A~170A	
		NRE8-630	205A~620A	
 <p>NC7-09~95 Mechanical interlock module</p>	How to purchase the products of 95A or lower	Purchase individually	How to purchase the products of 205A or higher	Purchase it individually, and install it by yourself
		Reversible product without connecting wire		
		Reversible product with connecting wire		
 <p>NC7-115~170 Mechanical interlock</p>  <p>NC7-205~620 Mechanical interlock</p>	Over 205A product mechanical interlocking mechanism code	Horizontal installation	NJLs-GG	NC7-205 Combination of two units
			NJLs-HH	NC7-250~300 Combination of two arbitrary units
			NJLs-KK	NC7-410~475 Combination of two arbitrary units
			NJLs-LL	NC7-620 Combination of two units
		Vertical installation	NJLc-GG	NC7-205 Combination of two units
			NJLc-GH	NC7-205 and NC7-250~300
			NJLc-GK	NC7-205 and NC7-410~475
			NJLc-GL	NC7-205 and NC7-620
			NJLc-HH	NC7-250~300 Combination of two units
			NJLc-HK	NC7-250~300 and NC7-410~475
			NJLc-HL	NC7-250~300 and NC7-620
			NJLc-KK	NC7-410~475 Combination of two units
			NJLc-KL	NC7-410~475 and NC7-620
			NJLc-LL	NC7-620 Combination of two units



5. Main parameters and technical performance

5.1 Main parameters and technical performance criteria for the NC7 product

Type			NC7-09	NC7-12	NC7-18	NC7-22	NC7-25	NC7-32	NC7-38	NC7-40	NC7-50	NC7-65	NC7-80	NC7-95										
Rated operational current (A)	380V/400V	AC-3	9	12	18	22	25	32	38	40	50	65	80	95										
		AC-4	3.5	5	7.7	7.7	8.5	12	12	18.5	24	28	37	44										
	660V/690V	AC-3	6.6	8.9	12	14	18	22	22	34	39	42	49	49										
		AC-4	1.5	2	3.8	3.8	4.4	7.5	7.5	9	12	14	17.3	21.3										
Appointed free air heat generation current (A)			20	20	32	32	40	50	50	60	80	80	110	110										
Rated insulation voltage (V)			690	690	690	690	690	690	690	690	690	690	690	690										
Rated impulse withstand voltage (kV)			6	6	6	6	6	6	6	8	8	8	8	8										
Rated making capacity			Making current: 10xIe(AC-3) or 12xIe(AC-4)																					
Rated breaking capacity			Making/breaking current: 8xIe(AC-3) or 10xIe(AC-4)																					
Short time withstand current (10s)			72	96	144	176	200	256	304	320	400	520	640	760										
Controllable three-phase squirrel-cage motor power(AC-3)kW	380V/400V		4	5.5	7.5	11	11	15	18.5	18.5	22	30	37	45										
	660V/690V		5.5	7.5	10	11	15	18.5	18.5	30	37	37	45	45										
Intermittent-periodic-duty motor power(AC-4)kW	380V/400V		1.5	2.2	3	3	4	5.5	5.5	7.5	11	15	18.5	22										
	600V/690V		1.1	1.5	3.7	3.7	4	5.5	5.5	7.5	11	11	15	18.5										
Frequency of operation (times/h)	Electrical life	AC-3	1200	1200	1200	1200	1200	600	600	600	600	600	600	600										
		AC-4	300	300	300	300	300	300	300	300	300	300	120	120										
	Mechanical life		3600	3600	3600	3600	3600	3600	3600	3600	3600	3600	3600	3600										
Electrical life (ten thousand times)	AC-3		100	100	100	100	100	80	80	80	60	60	60	60										
		AC-4	20	20	20	20	20	20	20	15	15	15	10	10										
Mechanical life(ten thousand times)			1000	1000	1000	1000	1000	800	800	800	800	800	600	600										
Type of the fuse adapted			RT16-20	RT16-20	RT16-32	RT16-32	RT16-40	RT16-50	RT16-50	RT16-63	RT16-80	RT16-80	RT16-100	RT16-125										
Piece (of string, etc)			1 2	1 2	1 2	1 2	1 2	1 2	1 2	1 2	1 2	1 2	1 2	1 2										
Cold-pressed terminal	Non-prefabricated-tip cord Cord with the prefabricated tip Non-prefabricated-tip hard wire	mm ²	1/2.5	1/2.5	1.5/4	1.5/4	1.5/4	1.5/4	1.5/4	2.5/6	2.5/6	2.5/6	2.5/6	6/25	4/10	6/25	4/10	6/25	4/10	10/35	6/16	10/35	6/16	
			1/4	1/2.5	1/4	1/2.5	1.5/6	1.5/4	1.5/6	1.5/4	1.5/10	1.5/6	2.5/10	2.5/6	2.5/10	2.5/6	6/25	4/10	6/25	4/10	10/35	6/16	10/35	6/16
			1/4	1/4	1/4	1/4	1.5/6	1.5/6	1.5/6	1.5/6	2.5/10	2.5/10	2.5/10	2.5/10	6/25	4/10	6/25	4/10	6/25	4/10	10/35	6/16	10/35	6/16
Connection terminal screw size and tightening torque (N•m)			M3.5	M3.5	M3.5	M3.5	M4	M4	M4	M8	M8	M8	M10	M10										
			0.8	0.8	0.8	0.8	1.2	1.2	1.2	4	4	4	6	6										
AC coil power	50Hz	Attracting(VA)	70	70	70	70	110	110	110	200	200	200	200	200										
		Holding(VA)	9	9	9.5	9.5	14	19	19	57	57	57	57	57										
		Power(W)	1.8~2.7	1.8~2.7	3~4	3~4	3~4	3~4	3~4	6~10	6~10	6~10	6~10	6~10										
Action (actuating)range			Pull-in voltage: 85%Us~110%Us; Release voltage: 20%Us~75%Us																					
Basic parameters of the auxiliary contact			AC-15 : 0.95A 380V/400V DC-13 : 0.15A 220V/250V Ith : 10A																					

5.2 Rated control source voltage Us and code for the NC7 ac contactor of 170A or lower

Coil voltage Us(V)	24	36	42	48	110	127	220	230	240	380	400	415	440	480	500	600	660
50Hz	B5	C5	D5	E5	F5	G5	M5	P5	U5	Q5	V5	N5	R5	T5	S5	X5	Y5
60Hz	B6	C6	D6	E6	F6	G6	M6	P6	U6	Q6	V6	N6	R6	T6	S6	X6	Y6
50/60Hz	B7	C7	D7	E7	F7	G7	M7	P7	U7	Q7	V7	N7	R7	T7	S7	X7	Y7

Type			NC7-115	NC7-150	NC7-170	NC7-205	NC7-250	NC7-300	NC7-410	NC7-475	NC7-620
Rated operational current (A)	380V/400V	AC-3	115	150	170	205	250	300	410	475	620
		AC-4	115	150	150	205	250	300	410	475	620
	660V/690V	AC-3	86	107	118	137	170	235	303	353	462
		AC-4	86	107	107	137	170	235	303	353	462
Appointed free air heat generation current (A)			200	200	275	275	315	380	450	630	800
Rated insulation voltage (V)			1000	1000	1000	1000	1000	1000	1000	1000	1000
Rated impulse withstand voltage (kV)			8	8	8	8	8	8	8	8	8
Rated making capacity			Making current: 10Ie(AC-3) or 12Ie(AC-4)								
Rated breaking capacity			Making/breaking current: 8Ie(AC-3) or 10Ie(AC-4)								
Short time withstand current (10s)			920	1200	1360	1640	2000	2400	3280	3800	4960
Controllable three-phase squirrel-cage motor power(AC-3)kW	380V/400V	55	75	90	110	132	160	200	265	335	
	660V/690V	80	100	110	129	160	220	280	335	450	
Intermittent-periodic-duty motor power(AC-4)kW	380V/400V	55	75	90	110	132	160	200	265	335	
	600V/690V	80	100	110	129	160	220	280	335	450	
Frequency of operation (times/h)	Electrical life	AC-3	1200	1200	600	600	600	600	600	600	600
		AC-4	120	120	120	60	60	60	60	60	60
Mechanical life			1200	1200	600	600	600	600	600	600	600
Electrical life (ten thousand times)	AC-3	80	80	60	60	60	60	60	60	60	60
	AC-4	2	2	1	1	1	1	1	0.6	0.6	
Mechanical life(ten thousand times)			600	600	600	600	600	600	600	600	600
Type of the fuse adapted			NT3-225	NT3-225	NT3-315	RT16-3	RT16-3	RT16-3	RT16-3	RT16-4	RT16-4
AC coil power 50Hz	Attracting(VA) Holding(VA) Power(W)		115	150	170						
			660	660	660						
			91.2	91.2	91.2						
			10-15	10-15	10-15						
Action (actuating)range			Pull-in voltage: 85%Us~110%Us; Release voltage: 20%Us~75%Us; NC7-250~620 Release voltage: 10%Us~75%Us								
Basic parameters of the auxiliary contact			AC-15: 0.95A 380V/400V DC-13: 0.15A 220/250V Ith: 10A								



















Type	NC7-115	NC7-150	NC7-170	NC7-205	NC7-250	NC7-300	NC7-410	NC7-475	NC7-620
Piece (of string, etc)	2	2	2	1	1	1	1 (2)	2	2
Cable (mm ²)	10~50	10~50	10~50	95~150	120~185	185~240	240 (150)	150~185	185~240
Copper (mm)	-	-	-	-	-	-	30X5	40X5	50X5
Bolt	M10	M10	M10	M10	M10	M10	M10	M10	M12
Tightening torque(N-m)	10	10	10	10	10	10	10	10	14

5.3 Rated control source voltage Us and code for the NC7 ac contactor (205A - 620A) product coil

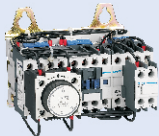
Coil code Contactor type	Control voltage (V)				Power VA		Schematic drawing
	110	127	220	380	Start	Hold	
NC7-205	FG110	FG127	FG220	FG380	966	66	
NC7-250	FI110	FI127	FI220	FI380	1500	18	
NC7-300	FI110	FI127	FI220	FI380	1500	18	
NC7-410	FJ110	FJ127	FJ220	FJ380	1500	20	
NC7-475	FK110	FK127	FK220	FK380	1500	25	
NC7-620	FL110	FL127	FL220	FL380	1700	30	

Note: Products of NC7-250 or higher are duplex winding ones.

6. Derivative products

Derivative products	Contactor	Auxiliary module	Schematic drawing
Reversing contactor		+ 	→ 
Reversing contactor		+ 	→ 
Timing-delay contactor		+ 	→ 
Star-delta starter		+  + 	→ 
Star-delta starter		+ 	→ 
Magnetic starter		+ 	→ 

7. Overall and mounting dimensions (mm)

NC7 09~38

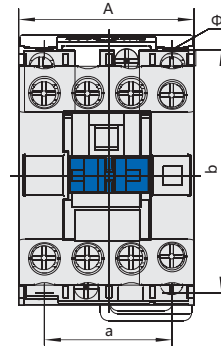
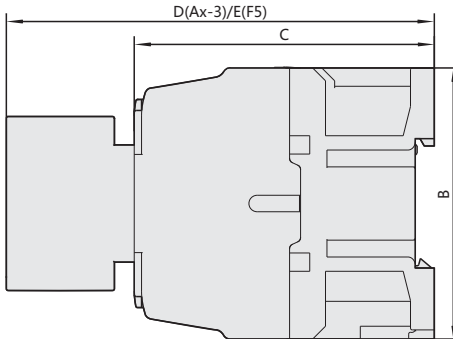

NC7 40~95

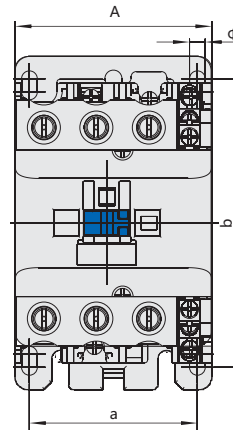
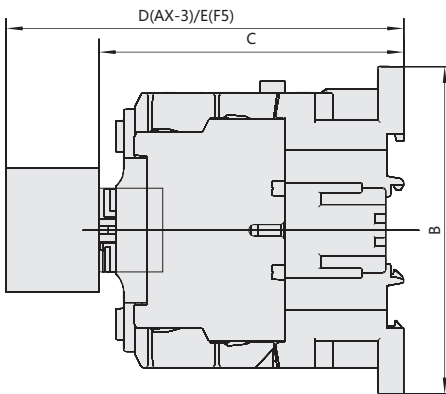

D

NC7 115~170

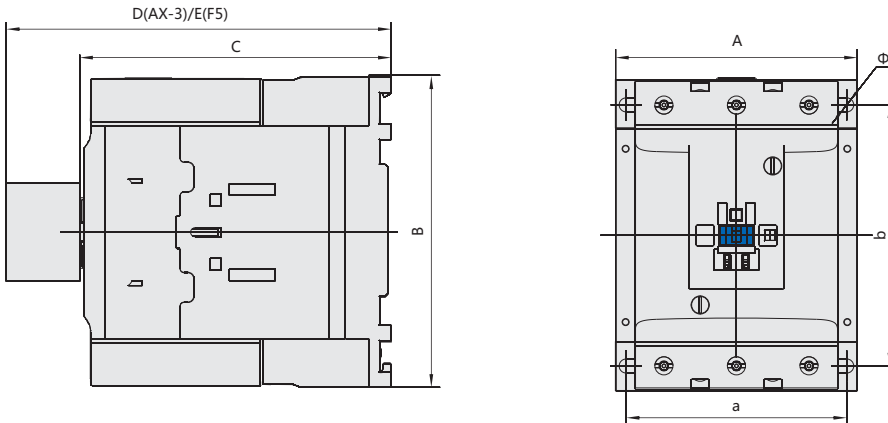

NC7 205~300

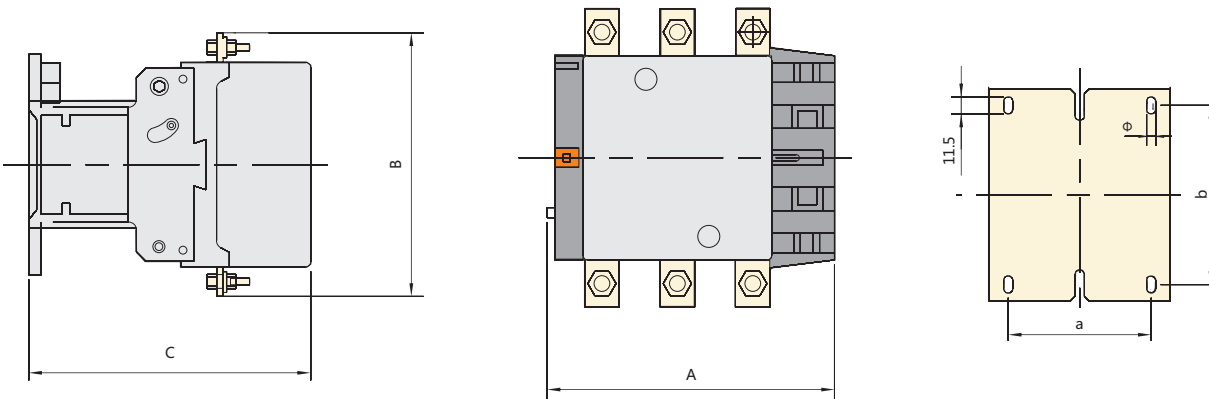

NC7 410~475

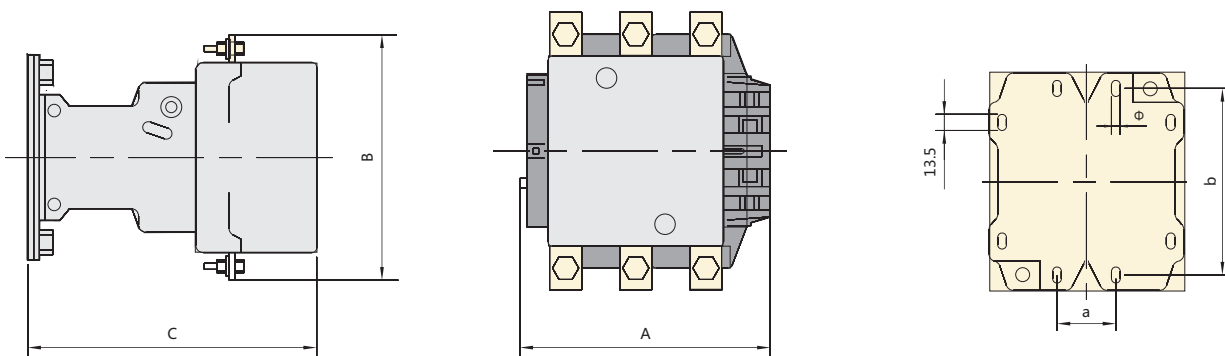

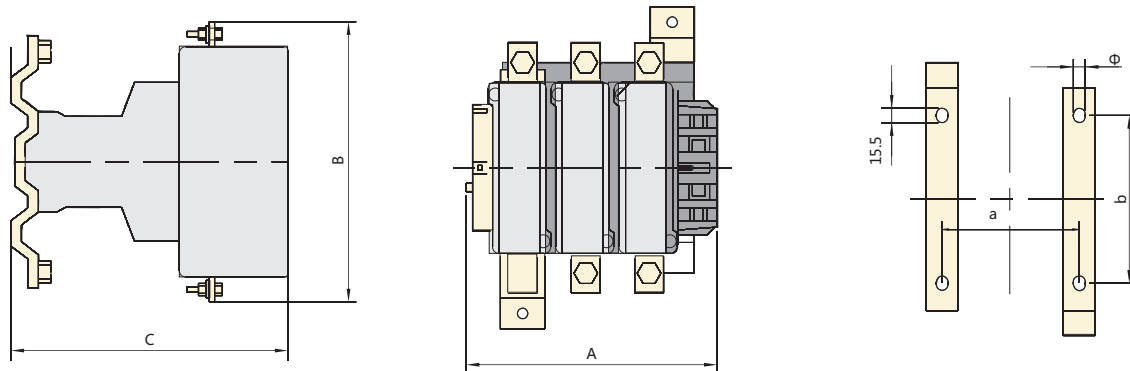

mm

Type	Amax	Bmax	Cmax	Dmax	Emax	a	b	Φ
NC7-0910~1210	47	76	86	124.5	144.5	34/35	50/60	4.5
NC7-0901~1201	47	76	86	124.5	144.5	34/35	50/60	4.5
NC7-0911~1211	45	75	88	124.5	144.5	34/35	50/60/61.8	4.5
NC7-1810	47	76	91	129.5	149.5	34/35	50/60	4.5
NC7-1801	47	76	91	129.5	149.5	34/35	50/60	4.5
NC7-1811~2211	45	75	91	127.5	147.5	34/35	50/60/61.8	4.5
NC7-2510	57	86	98	136.5	156.5	40	48	4.5
NC7-2501	57	86	98	136.5	156.5	40	48	4.5
NC7-2511	56	88	100	135.5	155.5	40	50/60/75	4.5
NC7-3210~3810	57	86	102	140.5	160.5	40	48	4.5
NC7-3201~3801	57	86	102	140.5	160.5	40	48	4.5
NC7-3211~3811	56	88	105	140.5	160.5	40	50/60/75	4.5
NC7-40~65	77	129	119	157.5	177.5	64	100~110	6
NC7-80~95	87	129	127	165.5	185.5	64	100~110	6
NC7-115~170	122	157	158	192.5	212.5	96~110	130	7
NC7-205	171	197	186			80	110~120	6.5
NC7-250	202	203	215			96	110~120	6.5
NC7-300	213	206	220			96	110~120	6.5
NC7-410	213	206	220			80	170~180	8.5
NC7-475	233	238	233			80	170~180	8.5
NC7-620	309	304	256			180	180~190	10.5

8. Ordering information

The following to be indicated when ordering:

- 8.1 Full name and type of the contactor
- 8.2 Rated control source voltage and frequency or size code of the coil
- 8.3 If you need to order the AX-3 auxiliary contactor block, F5 air delay head or standard rail track for the product, you should further give a clear indication; For products of 205A or higher, the auxiliary contactor blocks will not be attached for lack of indication such as the number of those blocks and how they are combined.
- 8.4 When the NC7 9A-170A products leave the factory, the body is not provided with the dust cap. It is hoped users will further give a clear indication when they need it.
- 8.5 Amount on order
- 8.6 The 95A-or-lower derivative N conventional products triple poles are provided in the mode of reversible wiring, so you must give clear indication for your special wiring mode.
- 8.7 The 205A-or-higher derivative NS conventional products triple poles are provided in the mode of reversible wiring, so you must give clear indication for your special wiring mode.
- 8.8 Order Sample:
 10 units of NC7-0910 ac contacts, coil voltage 220V/50Hz, with 5 pieces of AX/3-22
 10 units of NC7-300 ac contacts, coil voltage 220V/50Hz, with 10 pieces of AX/3-22 further attached

Mechanical interlocking mechanism to be order	Writing format for ordering
NC7-205 combined with NC7-620 Aertical installation, Mechanical interlocking mechanism, 30 sets	NJLc-GL 30 sets
Two NC7-250 combination in a mode of Horizontal installation, Mechanical interlocking mechanism, 30 sets	NJLc-HH 30 sets