

MSGS Series Large size Square Type Tower Light (horn speaker type)



The MSGS Series is a larger beacon that uses a mirrored parabolic reflector for increased visibility



Product Feature

- Incandescent type
- Outstanding visibility by magnified lens
- Red, Yellow, Green, Blue or Clear lens available
- Large rotating reflector
- Selectable audio sounds: 2-melody, 3-siren (100dB)
- Stud mounted

Dimensions <Unit: mm>

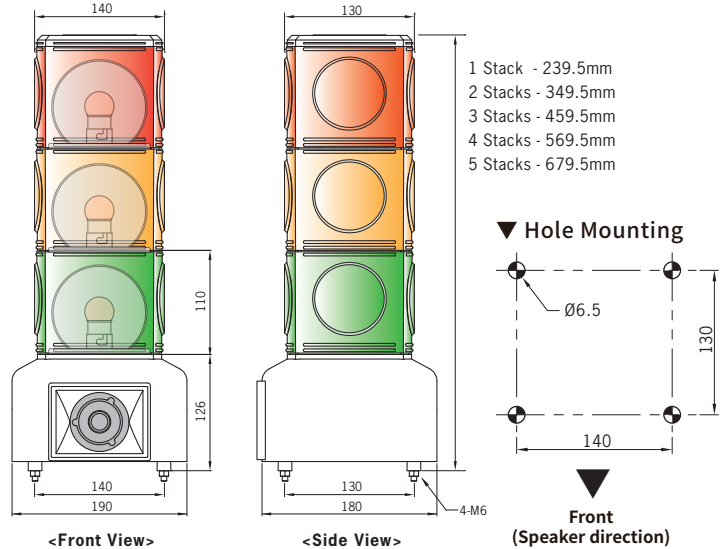

Ordering information

MSGS - 3 20 - RYG

① ② ③

① Number of Stack

1	1 Stack	4	4 Stacks
2	2 Stacks	5	5 Stacks
3	3 Stacks		

② Power Supply

01	12VDC	10	110VAC
02	24VDC	20	220VAC

③ Lens Color (Top to Bottom)

R	Red	B	Blue
Y	Yellow	C	Clear
G	Green		

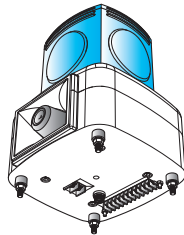

Specifications

Dimension	190 x 180 mm (Body Size)
Function	Rotating with 5 sounds (2 - melody, 3 - siren)
Power supply	12VDC, 24VDC, 110VAC, 220VAC (AC 50/60Hz)
Maximum stacked quantity	Fixed frame, 1, 2, 3, 4 or 5-stack version available
Lens color	Red, Yellow, Green, Blue, Clear
Rotating rate	max. 150±10rpm/minute
Sound volume	100±5dB at 1m
Vibration	0.75mm at 10~55Hz
Ambient temperature	-15 ~ 40°C
Storage ambient temperature	-25 ~ 70°C
Ambient humidity	45 ~ 85% RH
Protection structure	indoor (upright) IP20
Approval	RoHS
Connection	VSF / 0.75mm ² (Power supply wire only)

Current Consumption (RMS value ±10%)

Power Supply	12VDC	24VDC	110VAC	220VAC
Current (1 light+Sound)	2.4A	1.3A	0.4A	0.2A

▶ Bulb Replacement Parts

<p>Energy Used: 25 watt Base Type: Double Contact (BA15D) Color / Finish: Clear Length: 54mm Width: 22mm</p>	Input Voltage	Bulb	Part no.
	12V type	12V 25W	MAM-T15-D-012-25
	24V type	24V 25W	MAB-T15-D-024-25
	110V type	12V 25W	MAB-T15-D-012-25
	220V type	12V 25W	MAB-T15-D-012-25

Connection Diagram

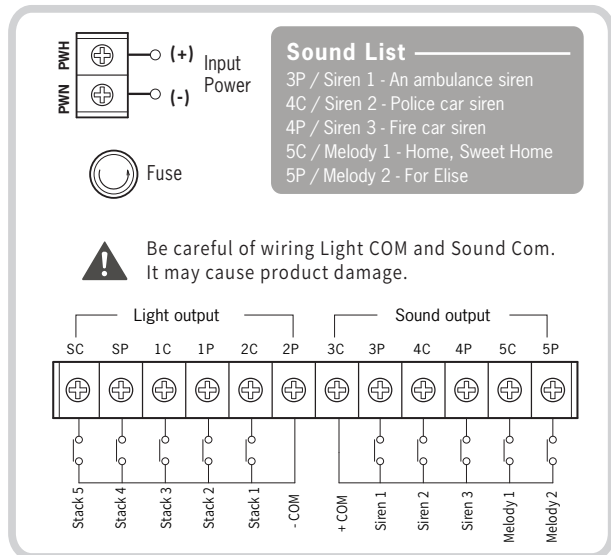

Optional Parts

Wall Mounting Bracket

MAM-DS33

Steel

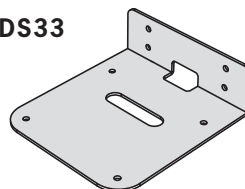

See Page 80 ~ 81 >> for Mounting Options and Accessories.

Accessories Parts

Ordering information and Dimensions (UNIT : mm)

Semi-assembled pole mounting base

PTE, PTM, PTD, PME, MT4, MT5 series

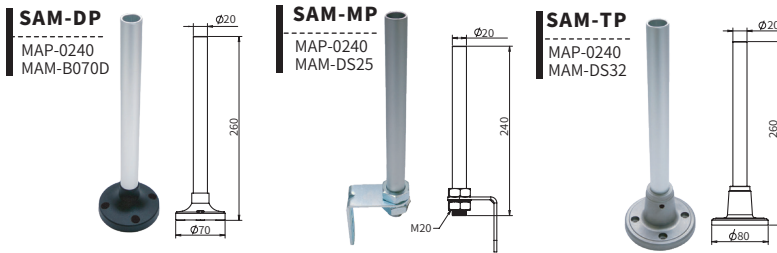

MS86 series dedicated part

MS115 series

MS135 series

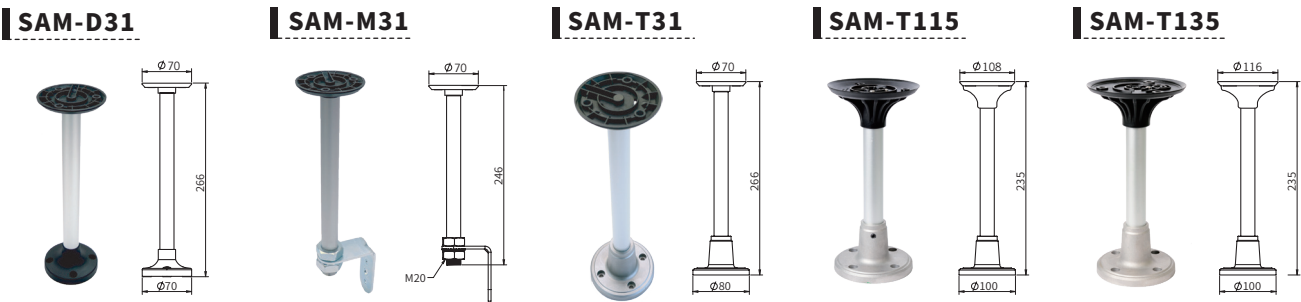

Wall Mounting Bracket

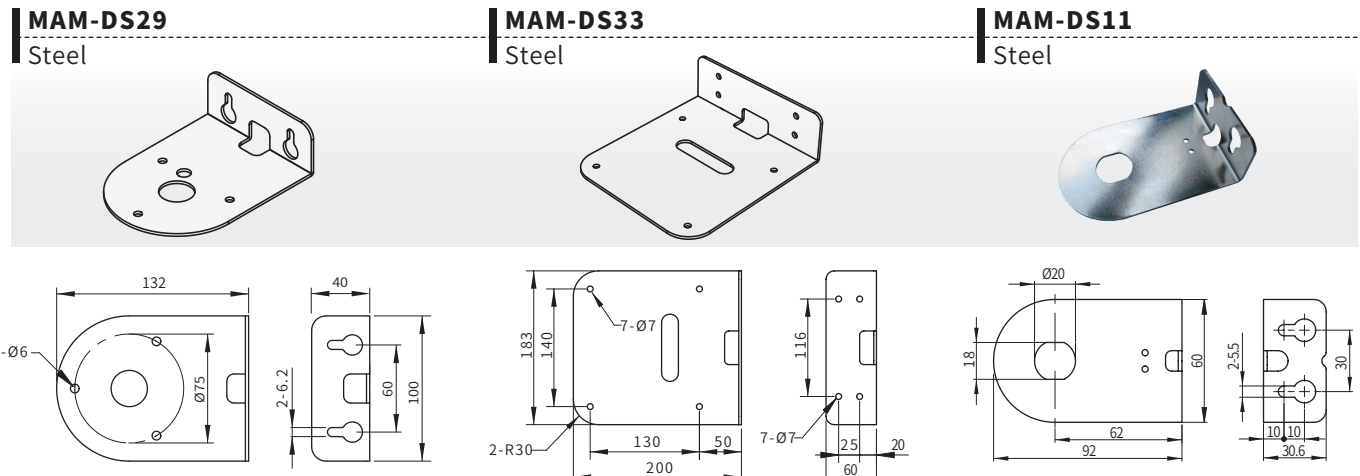
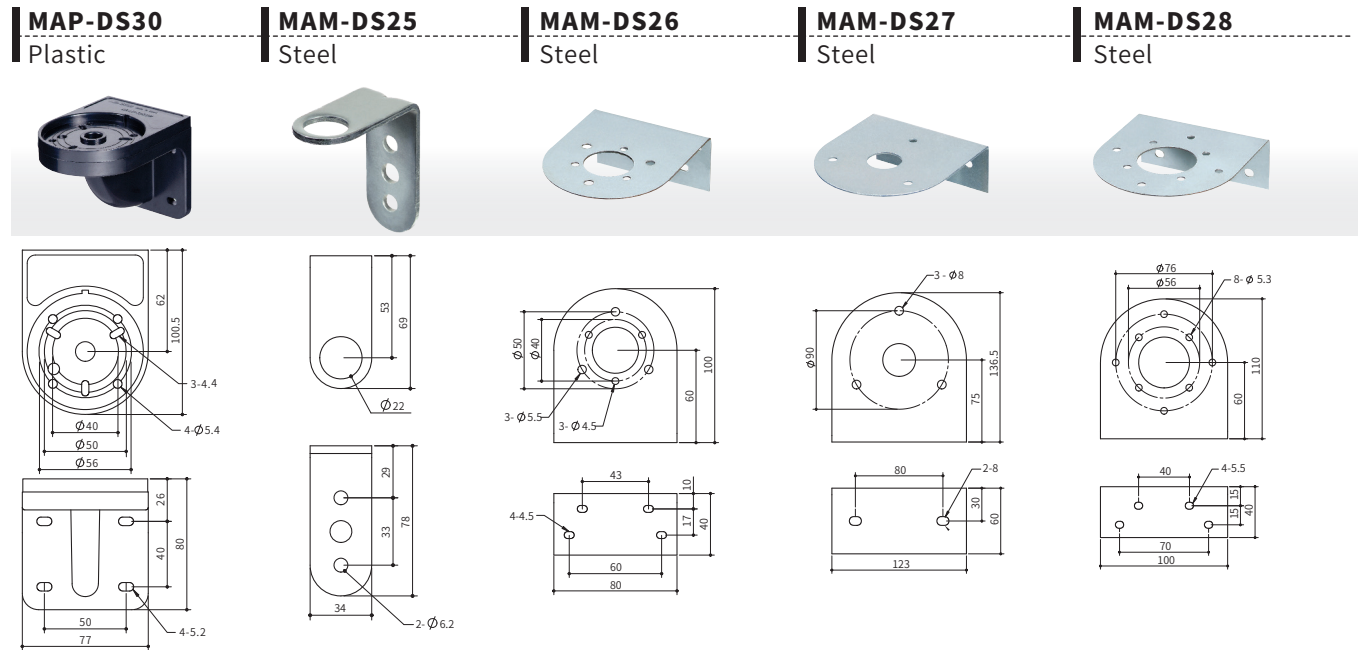

Mount Base

MAM-B070B

Plastic

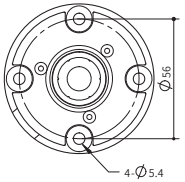
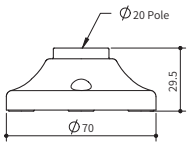

MAM-B070C

Plastic

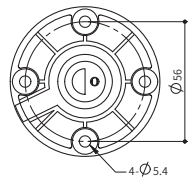
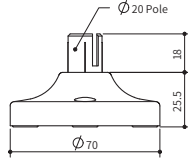

MAM-B070D

Plastic

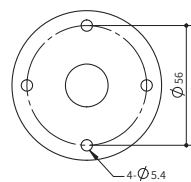
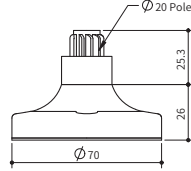

MAM-B070F

Plastic

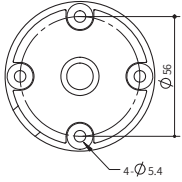
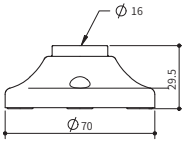

MAM-B070R

Plastic

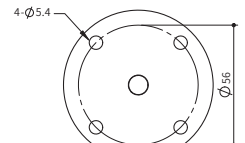
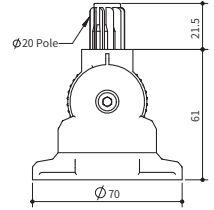

MAM-DS32A

Aluminum

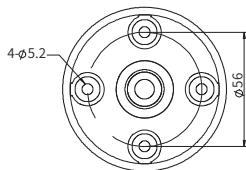
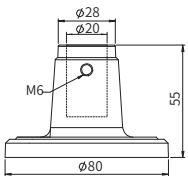

MAM-DS32B

Aluminum

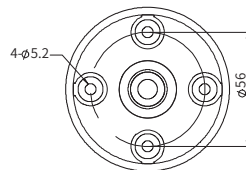
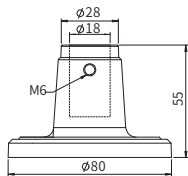

MAM-DS32C

Aluminum

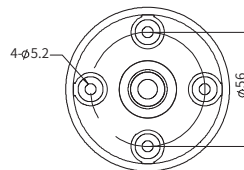
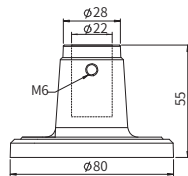

MAM-DS35

Aluminum

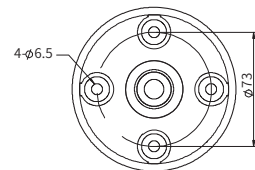
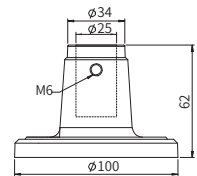

Wall Mounting Bracket

MAM-DS10

Steel

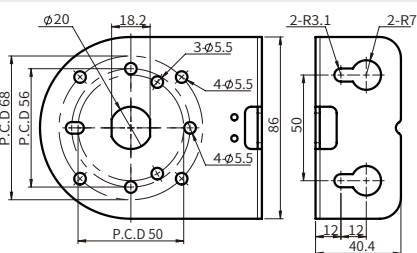
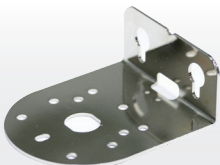

MAM-DS37

Steel

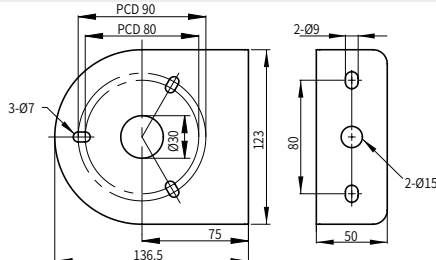
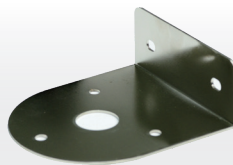

MAM-DS38

Steel

