

# One-touch Fittings

RoHS

## The New "KQ2"

KQ, KQ2, and KJ consolidated into the "KQ2"

- Enhanced variation
- Lightweight
- Compact



New KQ2 Series



**New** Oval type release button added!

Applicable tubing O.D.

Metric	ø3.2, ø4, ø6
Inch	ø1/8", ø5/32", ø3/16"



Body type: total of **51** models

Seal method: **3** types

Thread material/Surface treatment (Treated or Non-treated): **2** types<sup>\*1</sup>

\*1 Brass, Brass + Electroless nickel plating

Applicable tubing	Connection thread	Seal method/Release button shape					
		Sealant		Gasket seal		Face seal	
		Oval Type	Round Type	Oval Type	Round Type	Oval Type	Round Type
Metric size 	M						
	R	P.5	P.101	P.5	P.101	P.65	P.173
	G					P.57	P.165
	Uni			P.87	P.201		
Inch size 	UNF			P.29	P.133		
	NPT	P.29	P.133			P.73	P.185
	M			P.49	P.157		
	R	P.49	P.157			P.81	P.195
	Uni			P.95	P.209		

**KQ2 Series**

## Improved tube insertion/removal



## Compact and lightweight

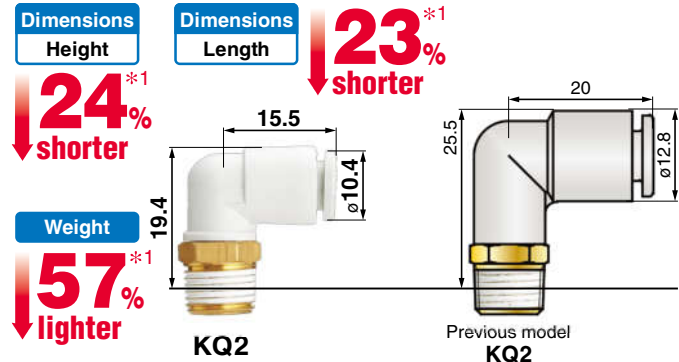

\*1 Tube removal strength is ensured to be equivalent to previous model. \*1 Previous KQ2 series model: Male elbow, applicable tubing O.D.  $\phi 6$ , connection thread R1/8

## Selectable seal method\*1

\*1 Connection thread: R, NPT



## Selectable surface treatment

- Brass (No plating)
- Brass + Electroless nickel plating

## Face seal adopted for threading.

Original thread construction which allows for the use of piping taper female threads (Rc, NPT)

Improved installability (Reduction in amount of tool-tightening required after hand-tightening)

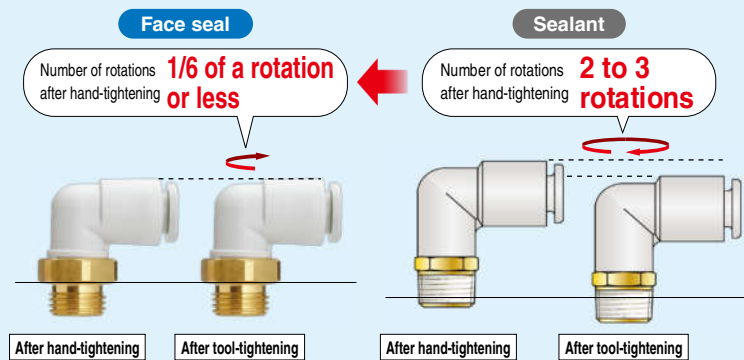

■ Allows for neat and compact piping without protruding threads

<Application example>  
Mounted to a blow gun (VMG11W-02-01)

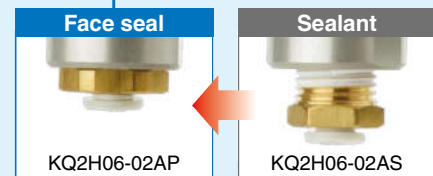

A uniform height when using multiple fittings, contributes to space saving

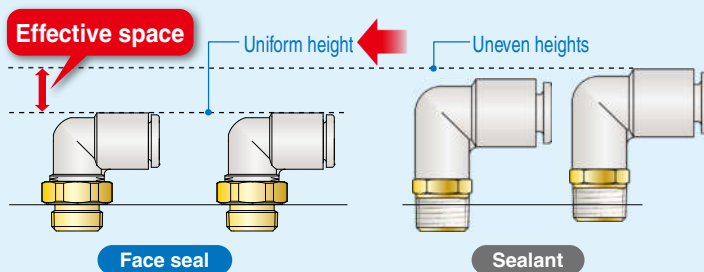

## Prevention of sealant residue/protrusion

The current sealant type leaves residue and protrudes out from the threading when installing, making it necessary to clear away the residue using an air blower or similar. However, no residue is created when using a face seal.

## Re-piping is possible.

### Face seal

Repeated re-piping of up to 6 to 10 times is possible due to use of elastic sealant on seating.





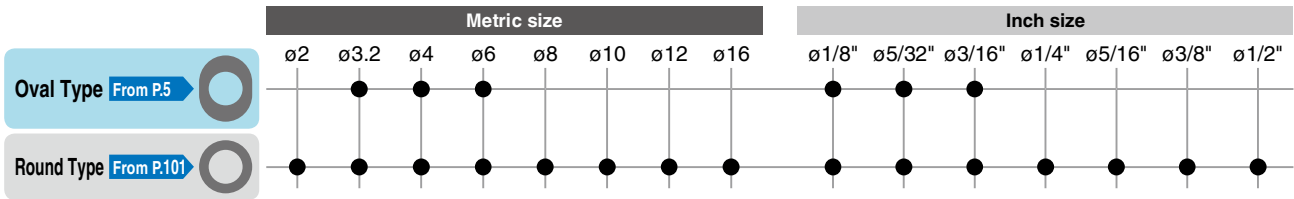







































































































### Sealant

Sealant tape is necessary because sealant becomes separated with repeated installation.



Refer to the next page for details on the applicable tubing sizes of each shape.



## Oval Type/Round Type Variations

<b>Hexagon Socket Head Male Connector</b> <b>KQ2S</b>   	<b>45° Male Elbow</b> <b>KQ2K</b>   	<b>Bulkhead Union</b> <b>KQ2E</b>   	<b>Universal Female Elbow</b> <b>KQ2VF</b>   
<b>Universal Male Elbow</b> <b>KQ2V</b>   	<b>Extended Male Elbow</b> <b>KQ2W</b>   	<b>Bulkhead Connector</b> <b>KQ2E</b>   	<b>Branch Universal Female Elbow</b> <b>KQ2ZF</b>  
<b>Male Connector</b> <b>KQ2H</b>   	<b>Female Connector</b> <b>KQ2F</b>   	<b>Straight Union</b> <b>KQ2H</b>   	<b>Different Diameter Straight</b> <b>KQ2H</b>   
<b>Cross</b> <b>KQ2TW</b>   	<b>Male Elbow</b> <b>KQ2L</b>   	<b>Union Elbow</b> <b>KQ2L</b>   	<b>Plug-in Elbow</b> <b>KQ2L</b>   
<b>Reducer Elbow</b> <b>KQ2L</b>   	<b>Different Diameter Cross</b> <b>KQ2TX</b>   	<b>Male Branch Tee</b> <b>KQ2T</b>   	<b>Union Tee</b> <b>KQ2T</b>   
<b>Different Diameter Tee</b> <b>KQ2T</b>   	<b>Different Diameter Tee</b> <b>KQ2T</b>   	<b>Different Diameter Cross</b> <b>KQ2TY</b>   	<b>Hexagon Socket Head Universal Male Elbow</b> <b>KQ2VS</b>   
<b>Branch Male Elbow</b> <b>KQ2LU</b>  	<b>Female Elbow</b> <b>KQ2LF</b>   	<b>Double Universal Male Elbow</b> <b>KQ2VD</b>   	<b>Triple Universal Male Elbow</b> <b>KQ2VT</b>   
<b>Branch Universal Male Elbow</b> <b>KQ2Z</b>  	<b>Double Branch Universal Male Elbow</b> <b>KQ2ZD</b>  	<b>Male Run Tee</b> <b>KQ2Y</b>   	<b>Triple Branch Universal Male Elbow</b> <b>KQ2ZT</b>  
<b>Branch Union Elbow</b> <b>KQ2LU</b>  	<b>Extended Plug-in Elbow</b> <b>KQ2W</b>   	<b>Male Delta Union</b> <b>KQ2D</b>   	<b>Delta Union</b> <b>KQ2D</b>   
<b>Double Branch "Y"</b> <b>KQ2UD</b>  	<b>Different Diameter Double Union "Y"</b> <b>KQ2UD</b>  	<b>Different Diameter Plug-in "Y"</b> <b>KQ2X</b>  	<b>Double Plug-in "Y"</b> <b>KQ2XD</b>  
<b>Union "Y"</b> <b>KQ2U</b>  	<b>Different Diameter Union "Y"</b> <b>KQ2U</b>  	<b>Plug-in "Y"</b> <b>KQ2U</b>  	<b>Branch "Y"</b> <b>KQ2U</b>  
<b>Plug-in Reducer</b> <b>KQ2R</b>   	<b>Bulkhead Male Elbow</b> <b>KQ2LE</b>   	<b>Tube Cap</b> <b>KQ2C</b>   	





\* The supported release button type (oval type/round type) is shown next to each product.

# Oval Type Release Button



## Sealant/Gasket Seal

Applicable tubing	Connection thread					
	M	R	Rc	UNF	NPT	
 <p><b>Metric</b></p> <p>ø2 ø3.2 ø4 ø6 ø8 ø10 ø12 ø16</p>	●	●	●			<p><b>P.5</b></p> <p>How to Order ..... P.6</p> <p>Variations ..... P.7</p> <p>Dimensions ..... P.9</p> <p>Made to Order/Clean Series/ Spare Parts ..... P.27</p>
 <p><b>Inch</b></p> <p>ø1/8" ø5/32" ø3/16" ø1/4" ø5/16" ø3/8" ø1/2"</p>				●	●	<p><b>P.29</b></p> <p>How to Order ..... P.30</p> <p>Variations ..... P.31</p> <p>Dimensions ..... P.33</p> <p>Made to Order/Clean Series/ Spare Parts ..... P.48</p>
 <p><b>Inch</b></p> <p>ø1/8" ø5/32" ø3/16" ø1/4" ø5/16" ø3/8" ø1/2"</p>	●	●	●			<p><b>P.49</b></p> <p>How to Order ..... P.50</p> <p>Variations ..... P.51</p> <p>Dimensions ..... P.52</p> <p>Made to Order/Clean Series/ Spare Parts ..... P.55</p>

## Face Seal

Applicable tubing	Connection thread					
	G	R	Rc	NPT	R	
 <p><b>Metric</b></p> <p>ø2 ø3.2 ø4 ø6 ø8 ø10 ø12 ø16</p>	●					<p><b>P.57</b></p> <p>How to Order ..... P.58</p> <p>Variations ..... P.59</p> <p>Dimensions ..... P.60</p> <p>Spare Parts ..... P.63</p>
 <p><b>Metric</b></p> <p>ø2 ø3.2 ø4 ø6 ø8 ø10 ø12 ø16</p>		●				<p><b>P.65</b></p> <p>How to Order ..... P.66</p> <p>Variations ..... P.67</p> <p>Dimensions ..... P.68</p>
 <p><b>Inch</b></p> <p>ø1/8" ø5/32" ø3/16" ø1/4" ø5/16" ø3/8" ø1/2"</p>				●		<p><b>P.73</b></p> <p>How to Order ..... P.74</p> <p>Variations ..... P.75</p> <p>Dimensions ..... P.76</p>
 <p><b>Inch</b></p> <p>ø1/8" ø5/32" ø3/16" ø1/4" ø5/16" ø3/8" ø1/2"</p>					●	<p><b>P.81</b></p> <p>How to Order ..... P.82</p> <p>Variations ..... P.83</p> <p>Dimensions ..... P.84</p>

## Gasket Seal (Uni Thread)

Applicable tubing	Connection thread				
	Rc	G	NPT	NPTF	
 <p><b>Metric</b></p> <p>ø2 ø3.2 ø4 ø6 ø8 ø10 ø12 ø16</p>	●	●	●	●	<p><b>P.87</b></p> <p>How to Order ..... P.88</p> <p>Variations ..... P.89</p> <p>Dimensions ..... P.90</p> <p>Made to Order/Clean Series/ Spare Parts ..... P.93</p>
 <p><b>Inch</b></p> <p>ø1/8" ø5/32" ø3/16" ø1/4" ø5/16" ø3/8" ø1/2"</p>	●	●	●	●	<p><b>P.95</b></p> <p>How to Order ..... P.96</p> <p>Variations ..... P.97</p> <p>Dimensions ..... P.98</p> <p>Made to Order/Clean Series/ Spare Parts ..... P.100</p>



# Metric Size One-touch Fittings

Applicable Tubing: Metric Size, Connection Thread: G

## KQ2 Series

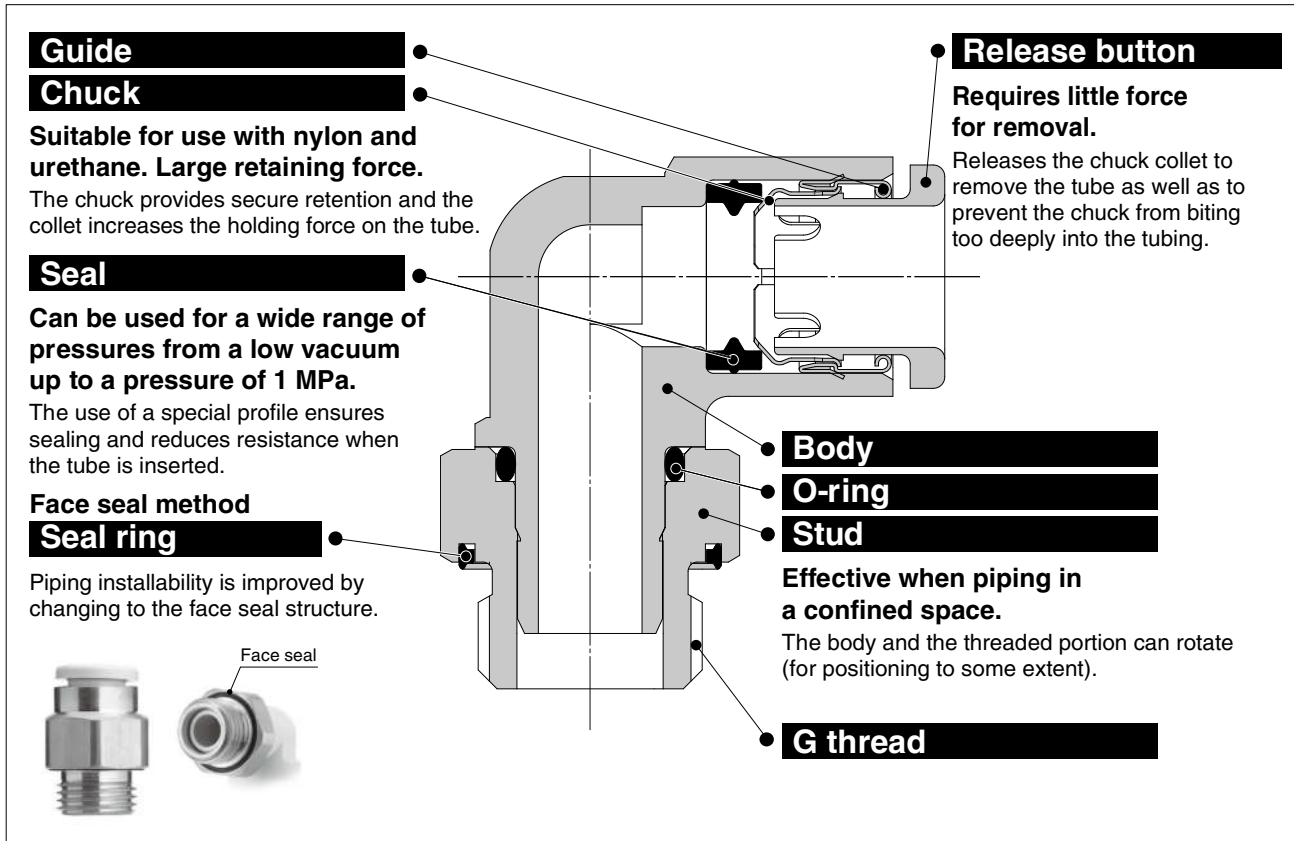

Applicable to parallel pipe thread (G).

Drastically reduces screw-in time with the face seal method.



### Applicable Tubing

Tubing material	FEP, PFA, Nylon, Soft nylon, Polyurethane
Tubing O.D.	ø4, ø6, ø8, ø10, ø12, ø16

### Specifications

<b>Fluid</b>		Air, Water*1 *2
<b>Operating pressure range*3</b>		-100 kPa to 1 MPa
<b>Proof pressure (at 23°C)</b>		3 MPa
<b>Ambient and fluid temperature</b>		-5 to 60°C, Water: 0 to 40°C (No freezing)
<b>Thread</b>	<b>Mounting section</b>	ISO 16030 (Parallel pipe thread)
	<b>Nut section</b>	JIS B0205 (Metric fine thread)
<b>Sealant on the threads</b>		Seal ring

\*1 The surge pressure must be under the maximum operating pressure.

\*2 Deionized water is not recommended for use as it may affect the material used in the fittings. In addition, it is known to degrade the water quality.

\*3 Do not use the fittings with a leak tester or for vacuum retention because they are not guaranteed for zero leakage.

### Principal Parts Material

Body	C3604, PBT
Stud	C3604 (Thread portion)
Chuck	Stainless steel 304
Guide	Stainless steel 304
Release button	POM
Seal, O-ring, Seal ring	NBR

# Metric Size One-touch Fittings **KQ2 Series**

Applicable Tubing: Metric Size, Connection Thread: G

## How to Order

**Threaded Type**

**KQ2 H 06 - G01 A**

One-touch fittings

Model

Symbol	Model
<b>H</b>	Male connector
<b>S</b>	Hexagon socket head male connector
<b>F</b>	Female connector
<b>L</b>	Male elbow
<b>V</b>	Universal male elbow
<b>W</b>	Extended male elbow
<b>T</b>	Male branch tee
<b>Y</b>	Male run tee
<b>E</b>	Bulkhead connector

Thread material/Surface treatment

Symbol	Thread material/Surface treatment
<b>A</b>	Brass
<b>N</b>	Brass + Electroless nickel plating

Port size

Symbol	Size
<b>G01</b>	G1/8
<b>G02</b>	G1/4
<b>G03</b>	G3/8
<b>G04</b>	G1/2

Applicable tubing O.D.

Symbol	Size
<b>04</b>	ø4
<b>06</b>	ø6
<b>08</b>	ø8
<b>10</b>	ø10
<b>12</b>	ø12
<b>16</b>	ø16

For details on applicable tubing O.D. and port size combinations for each model, refer to the charts on the Dimensions page.

Round Type  
**O**

Metric Size M, R, Rc

Sealant/Gasket Seal  
Inch Size UNF, NPT

Inch Size M, R, Rc

Metric Size G

Face Seal  
Metric Size R, Rc

Inch Size NPT

Inch Size R

Gasket Seal  
Metric Size Uni

Inch Size Uni

# Metric Size One-touch Fittings

## Round Type Variations

### Hexagon socket head male connector

**KQ2S**

P.168



Internal hexagon socket allows tightening with a hexagon wrench in confined spaces.

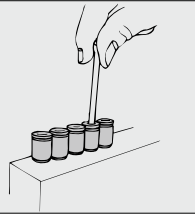

### Universal male elbow

**KQ2V**

P.169



Hexagon head of the body allows tightening with a box wrench in confined spaces.

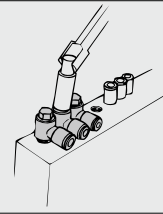

### Extended male elbow

**KQ2W**

P.170



Basically, it is used together with a male elbow. Its extended height allows for multi-leveled piping and prevents interference among fittings.

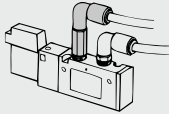

### Bulkhead connector

**KQ2E**

P.171



Use to connect a male thread and tubing through a panel, etc.

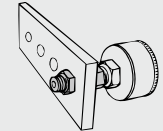

### Male connector

**KQ2H**

P.168



Use to pipe a female thread in the same direction. Most general model.

### Male elbow

**KQ2L**

P.169



Use to pipe a female thread at right angles. Most general model.

### Male run tee

**KQ2Y**

P.171



Use to branch a female thread in the same direction and at a 90° angle.

### Female connector

**KQ2F**

P.168



Use to pipe a male thread of a pressure gauge, etc.

### Male branch tee

**KQ2T**

P.170



Use to branch a female thread at both 90° angles.

<p>Tubing  One-touch fittings</p> <p>Plug-in reducer/Plug-in elbow etc.</p>	<p>Tubing  Tubing</p> <p>Union elbow/Union tee/Straight union etc.</p>	<p>Accessory</p> <p>Nipple/Plug etc.</p>	<p>Refer to page 103 and after for details.</p>
<p>Refer to page 103 and after for details.</p>			

# Metric Size One-touch Fittings **KQ2 Series**

Applicable Tubing: Metric Size, Connection Thread: G

## Dimensions

### Male Connector: KQ2H (Face seal)



Applicable tubing O.D. [mm]	Connection thread G	Model	H (Width across flats)	øD	L	A	M	Effective area [mm <sup>2</sup> ]		Min. port size	Weight [g]
								Nylon	Urethane		
ø4	1/8	KQ2H04-G01□	12	7.7	17.1	11.6	13.3	4.8	3.4	3	7.7
	1/4	KQ2H04-G02□	17	7.7	15.4	8.9	13.3	4.8	3.4	3	16.8
ø6	1/8	KQ2H06-G01□	12	9.7	17.3	11.8	13.3	13.1	10.4	4.5	6.6
	1/4	KQ2H06-G02□	17	9.7	15.4	8.9	13.3	13.1	10.4	4.5	14.8
ø6	3/8	KQ2H06-G03□	21	9.7	16.4	8.9	13.3	13.1	10.4	4.5	27.1
	1/8	KQ2H08-G01□	14	13	21.4	15.9	14.2	26.1	18	6	7.5
ø8	1/4	KQ2H08-G02□	17	13	19.9	13.4	14.2	26.1	18	6	15.5
	3/8	KQ2H08-G03□	21	13	16.4	8.9	14.2	26.1	18	6	23.8
ø10	1/8	KQ2H10-G01□	17	15.6	23.2	17.7	15.6	26.1	26.1	6	15.7
	1/4	KQ2H10-G02□	17	15.6	22.8	16.3	15.6	41.5	29.5	7.5	16.8
ø10	3/8	KQ2H10-G03□	21	15.6	21.8	14.3	15.6	41.5	29.5	7.5	26.1
	1/2	KQ2H10-G04□	27	15.6	17.9	8.9	15.6	41.5	29.5	7.5	39.9
ø12	1/4	KQ2H12-G02□	19	18.2	25.3	18.8	17	58.3	46.1	9	15.1
	3/8	KQ2H12-G03□	21	18.2	23.6	16.1	17	58.3	46.1	9	25.6
ø12	1/2	KQ2H12-G04□	27	18.2	24.8	15.8	17	58.3	46.1	9	46.9
	3/8	KQ2H16-G03□	27	23.6	30.5	23	20.6	81	67	11	47.1
ø16	1/2	KQ2H16-G04□	27	23.6	29.7	20.7	20.6	113	67	13	48.8

□: A (Brass), N (Brass + Electroless nickel plating)

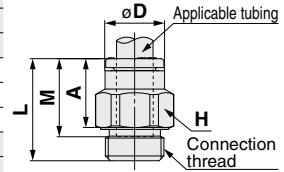

### Hexagon Socket Head Male Connector: KQ2S (Face seal)



Applicable tubing O.D. [mm]	Connection thread G	Model	H (Width across flats)	øD	L1	L2	A	M	Effective area [mm <sup>2</sup> ]		Min. port size	Weight [g]
									Nylon	Urethane		
ø4	1/8	KQ2S04-G01□	3	13	20.6	19.6	15.1	13.3	4.1	3.6	3.1	11.6
ø6	1/8	KQ2S06-G01□	4	13	19.8	18.8	14.3	13.3	10	9.9	4.1	9.7
	1/4	KQ2S06-G02□	4	18	19.8	18.8	13.3	13.3	10.7	10	4.1	18
ø6	1/8	KQ2S08-G01□	5	13	21.7	19.7	16.2	14.2	17.2	16.2	5.1	9.5
	1/4	KQ2S08-G02□	6	18	20.5	19.5	14	14.2	23.3	16.2	6.1	17.2
ø6	3/8	KQ2S08-G03□	6	22	20.7	19.7	13.2	14.2	23.3	16.2	6.1	27.1
	1/8	KQ2S10-G01□	5	15.6	23	21.1	17.5	15.6	17.2	16.2	5.1	10.9
ø10	1/4	KQ2S10-G02□	8	18	24.1	20.1	17.6	15.6	39	26.6	8.1	19.2
	3/8	KQ2S10-G03□	8	22	21.4	20.1	13.9	15.6	39	26.6	8.1	25
ø10	1/2	KQ2S10-G04□	8	26	21.1	20.1	12.1	15.6	39	26.6	8.1	34.1
	1/4	KQ2S12-G02□	8	18.2	25.6	21.5	19.1	17	46	44.5	8.1	18.3
ø12	3/8	KQ2S12-G03□	10	22	23.8	21.8	16.3	17	60	44.5	10.1	25.7
	1/2	KQ2S12-G04□	10	26	22.8	21.8	13.8	17	60	44.5	10.1	35.6
ø16	3/8	KQ2S16-G03□	10	23.6	30.8	25.4	23.3	20.6	81	67	10.1	29.2
	1/2	KQ2S16-G04□	12	26	30.3	26.1	21.3	20.6	113	67	12.1	45.8

□: A (Brass), N (Brass + Electroless nickel plating)

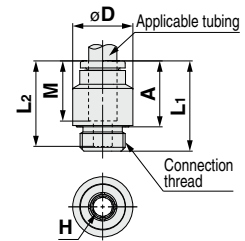

### Female Connector: KQ2F



Applicable tubing O.D. [mm]	Connection thread G	Model	H (Width across flats)	øD	L1	L2	M	Effective area [mm <sup>2</sup> ]		Min. port size	Weight [g]
								Nylon	Urethane		
ø4	1/8	KQ2F04-G01□	14	7.9	24.7	9.5	13.3	5.6	4	3	12.4
	1/4	KQ2F04-G02□	17	7.9	30.1	13.9	13.3	5.6	4	3	21.3
ø6	1/8	KQ2F06-G01□	14	9.9	24.3	9.5	13.3	13.1	10.4	4.5	12.6
	1/4	KQ2F06-G02□	17	9.9	29.6	13.9	13.3	13.1	10.4	4.5	21.4
ø6	3/8	KQ2F06-G03□	21	9.9	31.1	13.7	13.3	13.1	10.4	4.5	29.6
	1/8	KQ2F08-G01□	14	13	24.7	9.5	14.2	26.1	18	6	15.1
ø8	1/4	KQ2F08-G02□	17	13	30.1	13.9	14.2	26.1	18	6	24
	3/8	KQ2F08-G03□	21	13	31.6	13.7	14.2	26.1	18	6	32.3
ø10	1/4	KQ2F10-G02□	17	15.6	31.1	13.9	15.6	41.5	29.5	7.5	24.1
	3/8	KQ2F10-G03□	21	15.6	32.6	13.7	15.6	41.5	29.5	7.5	32.6
ø10	1/4	KQ2F12-G02□	19	18.2	32	13.8	17	58.3	46.1	9	33
	3/8	KQ2F12-G03□	21	18.2	33.5	13.7	17	58.3	46.1	9	34.1
ø12	1/2	KQ2F12-G04□	27	18.2	38.6	16.9	17	58.3	46.1	9	64.9
	3/8	KQ2F16-G03□	24	23.6	36	14.4	20.6	81	67	13	55.7
ø16	1/2	KQ2F16-G04□	27	23.6	41.1	16.9	20.6	113	67	13	71.7

□: A (Brass), N (Brass + Electroless nickel plating)

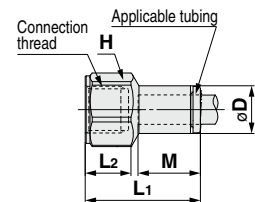

Round Type

Metric Size M, R, Rc

Inch Size UNF, NPT

Inch Size M, R, Rc

Metric Size G

Metric Size R, Rc

Inch Size NPT

Inch Size R

Metric Size Uni

Inch Size Uni



# KQ2 Series

Applicable Tubing: Metric Size, Connection Thread: G

## Dimensions

### Male Elbow: KQ2L (Face seal)



Applicable tubing O.D. [mm]	Connection thread G	Model	H (Width across flats)	øD1	øD2	L1	L2	A	M	Effective area [mm <sup>2</sup> ]		Min. port size	Weight [g]	With a rib
										Nylon	Urethane			
ø4	1/8	KQ2L04-G01□	12	8.2	10	14.8	16.8	15.4	13.3	4.6	3.3	3	6.3	●
	1/4	KQ2L04-G02□	17	8.2	10	14.8	20.3	17.9	13.3	4.6	3.3	3	16.7	●
ø6	1/8	KQ2L06-G01□	12	10.4	10	15.5	17.9	17.6	13.3	11.4	9	4.5	6.7	—
	1/4	KQ2L06-G02□	17	10.4	10	15.5	21.4	20.1	13.3	11.4	9	4.5	17.2	—
ø8	3/8	KQ2L06-G03□	21	10.4	10	15.5	22.4	20.1	13.3	11.4	9	4.5	28.9	—
	1/8	KQ2L08-G01□	12	13.2	10	16.4	19.3	20.4	14.2	11.4	11.4	4.5	7.6	●
ø10	1/4	KQ2L08-G02□	17	13.2	12	17.2	22.8	22.9	14.2	21.6	14.9	6	15.9	●
	3/8	KQ2L08-G03□	21	13.2	12	17.2	23.8	22.9	14.2	21.6	14.9	6	27.9	●
ø12	1/8	KQ2L10-G01□	12	15.9	12	18.6	22.5	24.9	15.6	21.6	14.9	6	10.3	●
	1/4	KQ2L10-G02□	17	15.9	17	19.3	24.6	26.0	15.6	35.2	25	7.5	17.5	●
ø16	3/8	KQ2L10-G03□	21	15.9	17	19.3	27.7	28.1	15.6	35.2	25	7.5	22.6	●
	1/2	KQ2L10-G04□	27	15.9	17	19.3	29.2	28.1	15.6	35.2	25	7.5	42.5	●
ø8	1/4	KQ2L12-G02□	17	18.5	17	21.5	25.9	28.6	17	50.2	39.7	9	19.3	●
	3/8	KQ2L12-G03□	21	18.5	17	21.5	29.0	30.7	17	50.2	39.7	9	24.5	●
ø12	1/2	KQ2L12-G04□	27	18.5	17	21.5	30.5	30.7	17	50.2	39.7	9	44.4	●
	3/8	KQ2L16-G03□	21	23.8	21	27.1	33.1	37.5	20.6	71	58.9	11	35.2	—
ø16	1/2	KQ2L16-G04□	27	23.8	21	27.1	33.8	36.7	20.6	100	58.9	13	58.7	—

□: A (Brass), N (Brass + Electroless nickel plating)

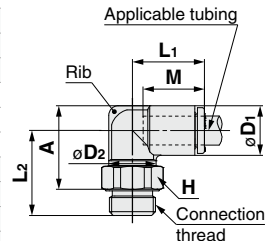

### Universal Male Elbow: KQ2V (Face seal)



Applicable tubing O.D. [mm]	Connection thread G	Model	H (Width across flats)	øD1	øD2	L1	L2	L3	A	M	Effective area [mm <sup>2</sup> ]		Min. port size	Weight [g]
											Nylon	Urethane		
ø4	1/8	KQ2V04-G01□	8	8.2	13.4	19.3	13	24.9	19.4	13.3	2.9	2.9	3	12.9
	1/4	KQ2V06-G02□	10	10.4	18	19.9	15	27.6	21.1	13.3	7.5	5.9	4.5	22.7
ø6	1/8	KQ2V06-G01□	8	10.4	13.4	20.5	13	24.9	19.4	13.3	7.5	5.9	4.5	13.2
	1/4	KQ2V08-G02□	12	13.2	17.6	23.5	15	27.5	22	14.2	16	11.2	5	24.5
ø8	3/8	KQ2V08-G03□	14	13.2	22	23.1	17.3	33.1	25.6	14.2	16	11.2	7.5	42.1
	1/4	KQ2V10-G02□	14	15.9	20.6	25.9	17.9	32.9	26.4	15.6	27	20.3	7.5	37.5
ø10	3/8	KQ2V10-G03□	14	15.9	22	25.9	18.1	33.1	25.6	15.6	27	20.3	7.5	43.4
	1/2	KQ2V12-G04□	17	18.5	25.2	28.5	20.5	36.7	29.2	17	39	30.8	9	60.5
ø12	1/2	KQ2V12-G04□	17	18.5	26	28.5	21.1	37.3	28.3	17	39	30.8	9	71
	3/8	KQ2V16-G03□	21	23.8	32.3	34.2	24.2	44.5	37	20.6	55	46	11	101.7
ø16	1/2	KQ2V16-G04□	21	23.8	32.3	34.2	26.2	46.5	37.5	20.6	78	46	13	106.6

□: A (Brass), N (Brass + Electroless nickel plating)

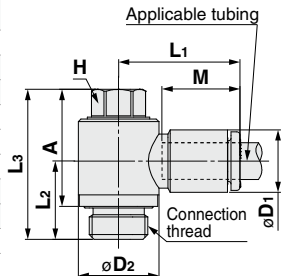

# Metric Size One-touch Fittings **KQ2 Series**

Applicable Tubing: Metric Size, Connection Thread: G

## Dimensions

### Extended Male Elbow: KQ2W (Face seal)



Applicable tubing O.D. [mm]	Connection thread G	Model	H (Width across flats)	øD1	øD2	L1	L2	A	M	Effective area [mm <sup>2</sup> ]		Min. port size	Weight [g]	With a rib
										Nylon	Urethane			
ø4	1/8	KQ2W04-G01	12	8.2	10	14.8	30.5	29.1	13.3	4	4	3	16.5	●
	1/4	KQ2W04-G02	17	8.2	10	14.8	31.2	28.8	13.3	4	4	3	35.8	●
ø6	1/8	KQ2W06-G01	12	10.4	10	15.5	31.6	31.3	13.3	10.9	8.6	4.5	17	—
	1/4	KQ2W06-G02	17	10.4	10	15.5	32.3	31	13.3	10.9	8.6	4.5	36.2	—
ø8	3/8	KQ2W06-G03	21	10.4	10	15.5	33.3	31	13.3	10.9	8.6	4.5	59.4	—
	1/8	KQ2W08-G01	12	13.2	10	16.4	33	34.1	14.2	10.9	10.9	4.5	17.8	●
ø10	1/4	KQ2W08-G02	17	13.2	12	17.2	36.5	36.6	14.2	20.5	14.2	6	37.5	●
	3/8	KQ2W08-G03	21	13.2	12	17.2	37.5	36.6	14.2	20.5	14.2	6	63.9	●
ø12	1/4	KQ2W10-G02	17	15.9	17	19.3	48.8	50.3	15.6	33.5	23.8	7.5	45.1	●
	3/8	KQ2W10-G03	21	15.9	17	19.3	46.6	47.1	15.6	33.5	23.8	7.5	62.6	●
ø16	1/2	KQ2W10-G04	27	15.9	17	19.3	48.1	47.1	15.6	33.5	23.8	7.5	120.2	●
	1/4	KQ2W12-G02	17	18.5	17	21.5	50.1	52.9	17	47.7	37.7	9	46.9	●
ø12	3/8	KQ2W12-G03	21	18.5	17	21.5	47.9	49.7	17	47.7	37.7	9	64.5	●
	1/2	KQ2W12-G04	27	18.5	17	21.5	49.4	49.7	17	47.7	37.7	9	122.1	●
ø16	3/8	KQ2W16-G03	21	23.8	21	27.1	57.4	61.8	20.6	71	58.9	11	71.7	—
	1/2	KQ2W16-G04	27	23.8	21	27.1	58.1	61	20.6	100	58.9	13	144.1	—

□: A (Brass), N (Brass + Electroless nickel plating)

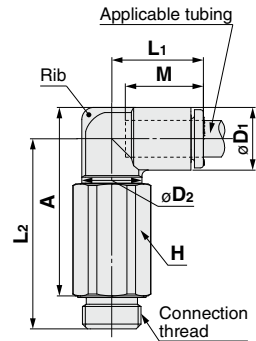

### Male Branch Tee: KQ2T (Face seal)



Applicable tubing O.D. [mm]	Connection thread G	Model	H (Width across flats)	øD1	øD2	L1	L2	A	M	Effective area [mm <sup>2</sup> ]		Min. port size	Weight [g]
										Nylon	Urethane		
ø4	1/8	KQ2T04-G01	12	8.2	10	14.8	16.8	15.4	13.3	6	4.1	3	7
	1/4	KQ2T04-G02	17	8.2	10	14.8	20.3	17.9	13.3	6	4.1	3	17.4
ø6	1/8	KQ2T06-G01	12	10.4	10	15.5	17.9	17.6	13.3	13.9	11	4.5	7.6
	1/4	KQ2T06-G02	17	10.4	10	15.5	21.4	20.1	13.3	13.9	11	4.5	18.1
ø8	3/8	KQ2T06-G03	21	10.4	10	15.5	22.4	20.1	13.3	13.9	11	4.5	29.8
	1/8	KQ2T08-G01	12	13.2	10	16.4	19.3	20.4	14.2	14	14	4.5	9.4
ø10	1/4	KQ2T08-G02	17	13.2	12	17.2	22.8	22.9	14.2	26.3	18.2	6	17.6
	3/8	KQ2T08-G03	21	13.2	12	17.2	23.8	22.9	14.2	26.3	18.2	6	29.6
ø12	1/8	KQ2T10-G01	12	15.9	12	18.6	22.4	24.9	15.6	21.6	14.9	6	13.1
	1/4	KQ2T10-G02	17	15.9	17	19.3	24.5	26	15.6	35.2	25	7.5	20.1
ø16	3/8	KQ2T10-G03	21	15.9	17	19.3	27.6	28.1	15.6	35.2	25	7.5	25.3
	1/2	KQ2T10-G04	27	15.9	17	19.3	29.1	28.1	15.6	35.2	25	7.5	45.2
ø12	1/4	KQ2T12-G02	17	18.5	17	21.5	25.8	28.6	17	57.2	45.2	9	23.1
	3/8	KQ2T12-G03	21	18.5	17	21.5	28.9	30.7	17	57.2	45.2	9	28.4
ø16	1/2	KQ2T12-G04	27	18.5	17	21.5	30.4	30.7	17	57.2	45.2	9	48.3
	3/8	KQ2T16-G03	21	23.8	21	27.1	33.1	37.5	20.6	71	58.9	11	42.1
ø16	1/2	KQ2T16-G04	27	23.8	21	27.1	33.8	36.7	20.6	100	58.9	13	65.7

□: A (Brass), N (Brass + Electroless nickel plating)

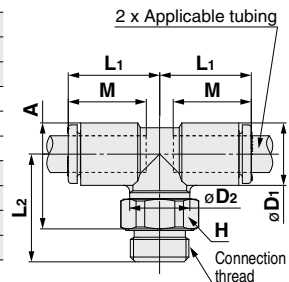

Round Type

Metric Size M, R, Rc

Inch Size UNF, NPT

Inch Size M, R, Rc

Metric Size G

Metric Size R, Rc

Inch Size NPT

Inch Size R

Metric Size Uni

Inch Size Uni

# KQ2 Series

Applicable Tubing: Metric Size, Connection Thread: G

## Dimensions

### Male Run Tee: KQ2Y (Face seal)



Applicable tubing O.D. [mm]	Connection thread G	Model	H (Width across flats)	øD1	øD2	L1	L2	L3	A	M	Effective area [mm <sup>2</sup> ]		Min. port size	Weight [g]
											Nylon	Urethane		
ø4	1/8	KQ2Y04-G01□	12	8.2	10	15.3	16.8	15.3	26.6	13.3	6.4	4.4	3	7
	1/4	KQ2Y04-G02□	17	8.2	10	15.3	20.3	15.3	29.1	13.3	6.4	4.4	3	17.5
ø6	1/8	KQ2Y06-G01□	12	10.4	10	16.3	17.9	16.3	28.7	13.3	13.4	10.6	4.5	7.7
	1/4	KQ2Y06-G02□	17	10.4	10	16.3	21.4	16.3	31.2	13.3	13.4	10.6	4.5	18.2
ø6	3/8	KQ2Y06-G03□	21	10.4	10	16.3	22.4	16.3	31.2	13.3	13.4	10.6	4.5	29.9
	1/8	KQ2Y08-G01□	12	13.2	10	18.2	19.3	18.2	32	14.2	13.4	13.4	4.5	9.5
ø8	1/4	KQ2Y08-G02□	17	13.2	12	18.2	22.8	18.2	34.5	14.2	25.6	17.7	6	17.7
	3/8	KQ2Y08-G03□	21	13.2	12	18.2	23.8	18.2	34.5	14.2	25.6	17.7	6	29.7
ø10	1/8	KQ2Y10-G01□	12	15.9	12	20.6	22.5	20.6	37.5	15.6	40	28.4	6	13.2
	1/4	KQ2Y10-G02□	17	15.9	17	20.6	24.6	20.6	38.6	15.6	40	28.4	7.5	20.3
	3/8	KQ2Y10-G03□	21	15.9	17	20.6	27.7	20.6	40.7	15.6	40	28.4	7.5	25.4
ø10	1/2	KQ2Y10-G04□	27	15.9	17	20.6	29.2	20.6	40.7	15.6	40	28.4	7.5	45.3
	1/4	KQ2Y12-G02□	17	18.5	17	23	25.9	23	42.3	17	57.4	45.4	9	23.4
	3/8	KQ2Y12-G03□	21	18.5	17	23	29	23	44.4	17	57.4	45.4	9	28.6
ø12	1/2	KQ2Y12-G04□	27	18.5	17	23	30.4	23	44.4	17	57.4	45.4	9	48.5
	3/8	KQ2Y16-G03□	21	23.8	21	28.6	33.1	28.6	54.2	20.6	81	60	11	42.7
ø16	1/2	KQ2Y16-G04□	27	23.8	21	28.6	33.8	28.6	53.4	20.6	113	60	13	66.2

□: A (Brass), N (Brass + Electroless nickel plating)

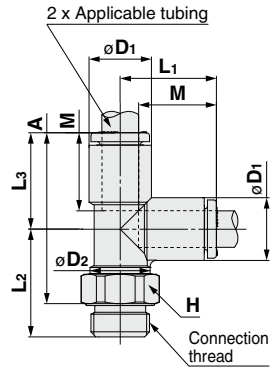

### Bulkhead Connector: KQ2E



Applicable tubing O.D. [mm]	Connection thread G	Model	T (M)	H1 (Width across flats)	H2 (Width across flats)	L1	L2	Mounting hole	M	Effective area [mm <sup>2</sup> ]		Min. port size	Weight [g]
										Nylon	Urethane		
ø4	1/8	KQ2E04-G01□	M12 x 1	14	14	25.1	10.7	13	13.3	5.6	4	3	21.3
	1/4	KQ2E04-G02□	M12 x 1	17	14	30.7	16.3	13	13.3	5.6	4	3	31.5
ø6	1/8	KQ2E06-G01□	M14 x 1	17	17	24.5	10.1	15	13.3	13.1	10.4	4.5	29.8
	1/4	KQ2E06-G02□	M14 x 1	17	17	30	15.6	15	13.3	13.1	10.4	4.5	32.8
ø6	3/8	KQ2E06-G03□	M14 x 1	21	17	32	17.6	15	13.3	13.1	10.4	4.5	45.5
	1/8	KQ2E08-G01□	M16 x 1	17	19	24.7	7.3	17	14.2	26.1	18	6	30.9
ø8	1/4	KQ2E08-G02□	M16 x 1	17	19	30	12.6	17	14.2	26.1	18	6	33.5
	3/8	KQ2E08-G03□	M16 x 1	21	19	33.1	15.7	17	14.2	26.1	18	6	46.1
ø10	1/4	KQ2E10-G02□	M20 x 1	22	24	31	11.6	21	15.6	41.5	29.5	7.5	66.7
	3/8	KQ2E10-G03□	M20 x 1	22	24	32.5	13.1	21	15.6	41.5	29.5	7.5	61.6
ø12	3/8	KQ2E12-G03□	M22 x 1	24	27	33.5	13.1	23	17	58.3	46.1	9	70.4
	1/2	KQ2E12-G04□	M22 x 1	27	27	39.9	19.5	23	17	58.3	46.1	9	94
ø16	3/8	KQ2E16-G03□	M28 x 1.5	30	32	35.9	13	29	20.6	96	67	13	127.6
	1/2	KQ2E16-G04□	M28 x 1.5	30	32	41	18.1	29	20.6	113	67	13	137.2

□: A (Brass), N (Brass + Electroless nickel plating)

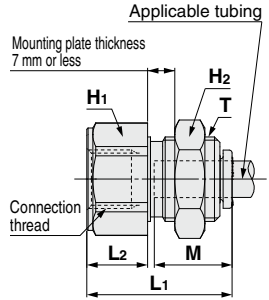

# KQ2 Series Spare Parts

Please contact SMC for detailed dimensions, specifications, and lead times.

## 1 Spare Parts

### Brass

Description	Part no.	Applicable model
Pipe nut	<b>KQ04-P01A</b>	KQ2E04-G01A, KQ2E04-G02A
	<b>KQ06-P01A</b>	KQ2E06-G01A, KQ2E06-G02A, KQ2E06-G03A
	<b>KQ08-P01A</b>	KQ2E08-G01A, KQ2E08-G02A, KQ2E08-G03A
	<b>KQ10-P01A</b>	KQ2E10-G02A, KQ2E10-G03A
	<b>KQ12-P01A</b>	KQ2E12-G03A, KQ2E12-G04A
	<b>KQ16-P01A</b>	KQ2E16-G03A, KQ2E16-G04A

### Brass + Electroless nickel plating

Description	Part no.	Applicable model
Pipe nut	<b>KQ04-P01N</b>	KQ2E04-G01N, KQ2E04-G02N
	<b>KQ06-P01N</b>	KQ2E06-G01N, KQ2E06-G02N, KQ2E06-G03N
	<b>KQ08-P01N</b>	KQ2E08-G01N, KQ2E08-G02N, KQ2E08-G03N
	<b>KQ10-P01N</b>	KQ2E10-G02N, KQ2E10-G03N
	<b>KQ12-P01N</b>	KQ2E12-G03N, KQ2E12-G04N
	<b>KQ16-P01N</b>	KQ2E16-G03N, KQ2E16-G04N

Round Type



Sealant/Gasket Seal  
Metric Size M, R, Rc

Inch Size UNF, NPT

Inch Size M, R, Rc

Metric Size G

Face Seal  
Metric Size R, Rc

Inch Size NPT

Inch Size R

Gasket Seal  
Metric Size Uni

Inch Size Uni

# For Pneumatic Piping/Fittings & Tubing Prior to Use

## Fittings with Sealant

Seal material (fluoresin) is coated on the thread part with the proper thickness and range, that reduces the piping work, such as coating the seal on the thread.

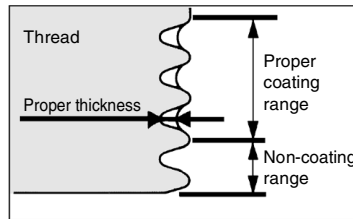
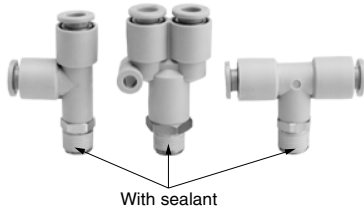

## Female Thread Conditions Applicable to Face Seal

1. Surface roughness of bearing surface: Rz 25 or less
  2. Chamfer dimension:  $\phi D1$ , Seal bearing surface diameter:  $\phi D2$  (Refer to the table below.)
  3. Female thread inclination angle:  $1^\circ$  or less
  4. Counterbore diameter when the female thread is counterbored.:  $\phi D3$ 
    - Models with width across flats: Body width across flats x 1.1 or more
    - Models other than hexagon (Hexagon socket head male connector etc.): Body dimensions + 0.2 mm or more
- \* The width across flats and the body dimensions differ depending on the model even when the same thread size is used.  
Refer to the dimensions in the catalog.
5. If oil content or sealant is sticking to the female thread, this may cause damage of the product. Remove it before piping.

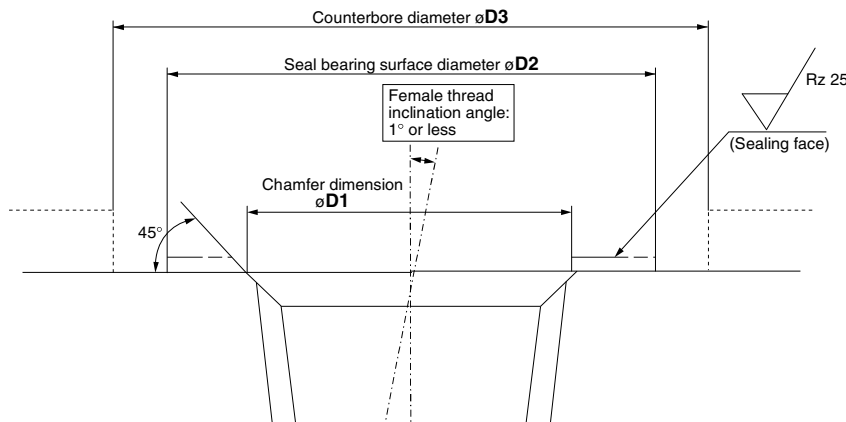

**Table 1**

Connection thread size	Chamfer dimension $\phi D1$ [mm]	Seal bearing surface diameter $\phi D2$ [mm]
R1/8	10.2 to 10.4	12 or more
R1/4	13.6 to 13.8	17 or more
R3/8	17.1 to 17.3	21 or more
R1/2	21.4 to 21.6	27 or more
NPT1/16	8.2 to 8.4	11.11 or more
NPT1/8	10.5 to 10.7	12.7 or more
NPT1/4	14.1 to 14.3	17.46 or more
NPT3/8	17.4 to 17.6	22 or more
NPT1/2	21.7 to 21.9	28.7 or more
G1/8	10.2 to 10.6	12 or more
G1/4	13.6 to 14.0	17 or more
G3/8	17.1 to 17.5	21 or more
G1/2	21.4 to 21.8	27 or more

### ⚠ Precautions

For products that do not satisfy the female thread conditions shown above and the piping with a piping pitch narrower than the product dimension, use the current sealant type.

\* The rubber parts of the face seal cannot be replaced.

\* The rubber parts of the face seal may fall off by the air blow and they cannot be mounted again. Be careful not to perform the air blow.





# Fittings & Tubing Precautions 1

Be sure to read this before handling products.

## Design / Selection

### ⚠ Warning

#### 1. Confirm the specifications.

Products represented in this catalog are designed only for use in compressed air systems (including vacuum). Do not operate at pressures, temperatures, etc., beyond the range of specifications, as this can cause damage or malfunction. (Refer to the specifications.)

Please contact SMC when using a fluid other than compressed air (including vacuum).

We do not guarantee against any damage if the product is used outside of the specification range.

#### 2. Do not disassemble the product or make any modifications, including additional machining.

It may cause human injury and/or an accident.

#### 3. Check if PTFE can be used in application.

PTFE powder (Polytetrafluoroethylene resin) is included in the sealant. Confirm that the use of it will not cause any adverse affect on the system.

### ⚠ Caution

#### 1. Keep the connection part of fittings and tubing from rotating or oscillating movement. Use Rotary One-touch Fittings (KS or KX series) in these cases.

The fittings may be damaged if they are used in the above manner.

#### 2. The tubing bending radius in the vicinity of the fitting should be at least the minimum bending radius of the tubing.

If the bending radius is less than the minimum value, fittings may damage, or tubing may crack or be crushed. The minimum bending radius of the FR soft nylon tubing (TRS series), FR double layer tubing (TRB series), antistatic soft nylon tubing (TAS series), polyolefin tubing (TPH series), and soft polyolefin tubing (TPS series) is measured as following in accordance with JIS B 8381.

Tubing deformation ratio at the minimum bending radius is obtained through the following formula, based on tubing diameter and mandrel diameter by winding the same radius mandrel tube.

$$\eta = \left(1 - \frac{L - D}{2d}\right) \times 100$$

Here,  $\eta$ : Deformation ratio [%]  
d: Tubing diameter [mm]  
L: Measured length [mm]  
D: Mandrel diameter [mm]  
(Twice against the minimum bending radius)  
Test temperature: 20 ±5°C  
Relative humidity: 65 ±5%

Tube deformation ratio at the minimum bending radius

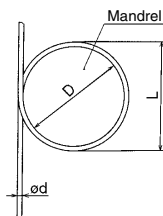

#### 3. Do not use fluids other than listed on the specifications.

Applicable fluids are air and water. Please consult with SMC if using other fluids.

#### 4. When it is used with water, the fittings or tubing may be damaged depending on the surge pressure.

#### 5. Depending on the storage or operating environment and the period of storage or use, the surface of the brass (C3604) may blacken. If the discoloration of the brass is a problem, we recommend selecting electroless nickel-plated brass instead.

Example) KQ2H06-01 NS

## Mounting / Piping

### ⚠ Warning

#### 1. Operation manual

Install the products and operate them only after reading the operation manual carefully and understanding its contents. Also, keep the manual where it can be referred to as necessary.

#### 2. Maintenance space

Allow sufficient space for maintenance and inspection.

#### 3. Adhere to the thread tightening method.

Refer to "Connection Thread Tightening Method" when mounting the product.

#### 4. There may be cases of the tubing detaching from the fitting and thrashing around uncontrollably due to tubing degradation or fitting breakage.

To prevent the situation from becoming uncontrollable, fit the tubing with a protective cover or fix it in place.

### ⚠ Caution

#### 1. Preparation before piping

Before piping is connected, it should be thoroughly blown out with air (flushing) or washed to remove chips, cutting oil and other debris from inside the pipe.

#### 2. Winding of sealant tape

When screwing together pipes and fittings, etc., be certain that chips from the pipe threads and sealant do not get inside the pipe.

Also, when the sealant tape is used, leave approx. 1 thread ridge exposed at the end of the threads.

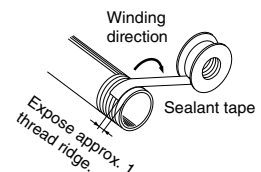

#### 3. Check the model, type and size before installation. Also, confirm that there is no scratches, gouges or cracks on the product.

#### 4. When connecting the tubing, take pressure or possible changes to the tubing length into account, and allow a sufficient margin.

Failure to do so may result in fitting breakage or detachment of the tubing. Refer to the recommended piping conditions.

#### 5. Do not apply unnecessary forces such as twisting, pulling, moment loads, vibration and impact, etc. on fittings or tubing.

This will cause damage to fittings and will crush, burst or release tubing.

#### 6. Tubing, with the exception of coiled tubing, requires stationary installation. Do not use standard tubing (non-coiled) in applications where tubing is required to travel inside the flexible protection tube. Tubing that travels may sustain abrasion, extension, or severance due to tensile force, or may result in removal of tubing from fitting. Use caution prior to use for proper application.

#### 7. To install the fitting, screw the fitting into the hexagonal face of the body, and tighten with an appropriate wrench.

Affix the wrench at the base of the thread. If the size of hexagonal face and wrench do not match, or tightening takes place near the tube side, it may cause collapse or deformation of the hexagonal face, or damage to the equipment. After installing, confirm that there is no damage to the fitting, etc.



# Fittings & Tubing Precautions 2

Be sure to read this before handling products.

## Mounting / Piping

### ⚠ Caution

#### 8. Interference in oval type release button

The following models cannot be used if a box wrench or socket wrench is used.

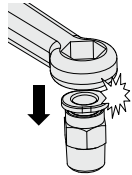

#### KQ2 Series

Model	Applicable tubing	Connection thread	Part number
Male connector	ø3.2	M3 x 0.5	KQ2H23-M3G1
	ø3.2	M5 x 0.8	KQ2H23-M5□1
	ø4	M3 x 0.5	KQ2H04-M3G1
	ø4	M5 x 0.8	KQ2H04-M5□1
	ø4	M6 x 1.0	KQ2H04-M6□1
	ø6	M5 x 0.8	KQ2H06-M5□1
	ø6	M6 x 1.0	KQ2H06-M6□1
	ø6	R1/8	KQ2H06-01□S1
	ø1/8	10-32UNF	KQ2H01-32□1
	ø5/32	10-32UNF	KQ2H03-32□1
	ø3/16	10-32UNF	KQ2H05-32□1
	ø5/32	NPT1/16	KQ2H03-33□S1
	ø1/8	M5 x 0.8	KQ2H01-M5□1
	ø3/16	M5 x 0.8	KQ2H05-M5□1
Female connector	ø4	M3 x 0.5	KQ2F04-M3□1
	ø4	M5 x 0.8	KQ2F04-M5□1
	ø6	M5 x 0.8	KQ2F06-M5□1
	ø1/8	10-32UNF	KQ2F01-32□1
	ø5/32	10-32UNF	KQ2F03-32□1
	ø1/8	M3 x 0.5	KQ2F23-M3□1
	ø1/8	M5 x 0.8	KQ2F23-M5□1

□: A (Brass), N (Brass + Electroless nickel plating)

#### KQ2-G Stainless Steel Series

Model	Applicable tubing	Connection thread	Part number
Male connector	ø4	M5 x 0.8	KQ2H04-M5G1
	ø6	M5 x 0.8	KQ2H06-M5G1
	ø6	R1/8	KQ2H06-01GS1

## Air Supply

### ⚠ Warning

#### 1. Type of fluids

Please consult with SMC when using the product in applications other than compressed air.

Regarding products for general fluids, please contact SMC concerning applicable fluids.

#### 2. When there is a large amount of drainage

Compressed air containing a large amount of drainage can cause malfunction of pneumatic equipment. An air dryer or water separator should be installed upstream from filters.

#### 3. Drain flushing

If condensation in the drain bowl is not emptied on a regular basis, the bowl will overflow and allow the condensation to enter the compressed air lines. This causes the malfunction of pneumatic equipment.

If the drain bowl is difficult to check and remove, the installation of a drain bowl with an auto drain option is recommended.

Refer to "SMC Air Preparation System" for further details on compressed air quality.

#### 4. Use clean air.

Do not use compressed air that contains chemicals, synthetic oils that include organic solvents, salt, corrosive gases, etc., as they can cause damage or malfunction.

## Air Supply

### ⚠ Caution

#### 1. Install an air filter.

Install an air filter at the upstream side of valve.  
Select an air filter with a filtration degree of 5 µm or finer.

#### 2. Install an aftercooler, air dryer or water separator, etc.

Compressed air containing a large amount of drainage can cause the malfunction of pneumatic equipment. Therefore, take appropriate measures to ensure air quality, such as by providing an aftercooler, air dryer, or water separator.

#### 3. Ensure that the fluid and ambient temperature are within the specified range.

If the fluid temperature is 5°C or less, the moisture in the circuit could freeze, causing damage to the seals and leading to equipment malfunction. Therefore, take appropriate measures to prevent freezing.

Refer to "SMC Air Preparation System" for further details on compressed air quality.

## Operating Environment

### ⚠ Warning

#### 1. Do not use in an atmosphere where corrosive gases, chemicals, sea water, water, or water steam is present. Do not use in cases where there is direct contact with any of the above.

Refer to each construction drawing on the fittings and tubing material.

#### 2. Do not expose the product to direct sunlight for an extended period of time.

#### 3. Do not use in a place subject to heavy vibration and/or impact.

#### 4. Do not mount the product in locations where it is exposed to radiant heat.

#### 5. Do not use the ordinary fittings and tubing in locations where static electricity would be problematic.

It may result in the system failure and trouble. In such places, use of antistatic fittings (KA series) and antistatic tubing (TA series) are recommended.

#### 6. Do not use the ordinary fittings and tubing in locations where spatter is generated.

Spattering may result in a fire hazard. In such a place, use of flame resistant fittings (KR/KRM series) and flame resistant tubing (TRS/TRB/TRBU/TRTU series) are recommended.

#### 7. Do not use in an environment where the product is directly exposed to cutting oil, lubricant, coolant oil, etc.

Please contact SMC if using for an environment exposed to cutting oil, lubricant or coolant oil, etc.

#### 8. Take note that if nylon tubing and soft nylon tubing are used in a clean room.

The antioxidant on the surface of the soft nylon tubing may come off, thereby lowering the cleanliness level.

#### 9. Do not use in environments where foreign matter may stick to the product or get mixed in the product's interior.

This may cause leakage or disconnection of the tubing.



# Fittings & Tubing Precautions 3

Be sure to read this before handling products.

## Maintenance

### ⚠ Warning

#### 1. Perform maintenance inspections according to the procedures indicated in the operation manual.

If handled improperly, malfunction and damage of machinery or equipment may occur.

#### 2. Maintenance work

If handled improperly, compressed air can be dangerous. The assembly, handling, repair, and element replacement of pneumatic systems should be performed by a knowledgeable and experienced person.

#### 3. Drain flushing

Remove drainage from air filters regularly.

#### 4. Removal of equipment and supply/exhaust of compressed air

When components are removed, first confirm that measures are in place to prevent workpieces from dropping, run-away equipment, etc. Then, cut off the supply pressure and electric power, and exhaust all compressed air from the system using the residual pressure release function.

When the equipment is restarted, proceed with caution after confirming that appropriate measures are in place to prevent cylinders from sudden movement.

### ⚠ Caution

#### 1. Be certain to wear safety glasses at all times during periodical inspections.

#### 2. Replace fittings or tubing having the following problems.

- 1) Cracks, gouges, wearing, corrosion
- 2) Air leakage
- 3) Twists or crushing of tubing
- 4) Hardening, deterioration, softening of tubing

#### 3. When replacing tubes or fittings, do not try to mend or repair and then reuse them.

## One-touch Fittings

### Mounting / Piping

### ⚠ Caution

#### 1. Installation and removal of tubing for One-touch fittings

##### 1) Installation of tubing

- (1) Cut the tubing perpendicularly, being careful not to damage the outside surface. Use an SMC tube cutter TK-1, 2, 3, 5 or 6. Do not cut the tubing with pliers, nippers, scissors, etc., otherwise, the tubing will be deformed and trouble may result.
- (2) The outside diameter of the polyurethane tubing swells when internal pressure is applied to it. Therefore, it may be possible that the tubing cannot be re-inserted into the One-touch fitting. Check the tubing outside diameter, and when the accuracy of the outside diameter is +0.07 mm or larger for  $\phi 2$ , +0.15 mm or larger for other sizes, insert into the One-touch fitting again, without cutting the tubing to use it. When the tubing is re-inserted into the One-touch fitting, confirm that the tubing goes through the release button smoothly.

## One-touch Fittings

### Mounting / Piping

### ⚠ Caution

(3) Grasp the tubing, slowly push it straight (0 to 5°) into the One-touch fitting until it comes to a stop.

(4) Pull the tubing back gently to make sure it has a positive seal. Insufficient installation may cause air to leak or the tubing to release.

As a guide for checking the tubing is not pulled out, refer to the following table.

Tubing size	Tensile force of tubing [N]
$\phi 2$ , 3.2, 1/8"	5
$\phi 4$ , 5/32", 3/16"	8
$\phi 6$ , 1/4"	12
$\phi 8$ , 5/16"	20
$\phi 10$ , 3/8"	30
$\phi 12$ , 1/2"	35
$\phi 16$	50

#### 2) Removal of tubing

(1) Push the release button flange evenly and sufficiently to release the tube. Do not push in the tubing before pressing the release button.

(2) Pull out the tubing while keeping the release button depressed. If the release button is not held down sufficiently, the tubing cannot be withdrawn.

(3) To reuse the tubing, remove the previously lodged portion of the tubing. If the lodged portion is left on without being removed, it may result in air leakage and removal of the tubing difficult.

#### 2. Connecting products with metal rods

Products with metal rods (KC series, previous KQ series, KN series, and KM series, etc.) cannot be connected to KQ2 series One-touch fittings. If connected, the metal rod cannot be retained by the chuck of the One-touch fitting and products with metal rods may project during pressurization, causing serious personal injury or accident.

Even when products with metal rods can be connected to other One-touch fittings, do not use any tube, resin plug, or reducer after connection. This may cause releasing.

For details about One-touch fittings that can connect products with metal rods, contact SMC.



# Fittings & Tubing Precautions 4

Be sure to read this before handling products.

## Connection Thread Tightening Method

### 1. Connection thread: M3

First, tighten by hand, then use a wrench appropriate for the hexagon flats of the body to tighten an additional 1/4 turn. A reference value for the tightening torque is 0.4 to 0.5 N·m.

### 2. Connection thread: M5 and 10-32UNF

First, tighten by hand, then use a wrench appropriate for the hexagon flats of the body to tighten an additional 1/6 to 1/4 turn. A reference value for the tightening torque is 1 to 1.5 N·m.

### 3. Connection thread: M6

First, tighten by hand, then use a wrench appropriate for the hexagon flats of the body to tighten an additional 1/6 to 1/4 turn.

\* Excessive tightening may damage the thread portion or deform the gasket and cause air leakage.

Insufficient tightening may loosen the threads, or cause air leakage.

### 4. Fittings with sealant: R, NPT

1) First, tighten the fitting by hand, then use a wrench appropriate for the hexagon flats of the body to tighten it a further two or three turns.

For a tightening torque guide, see the table below.

Connection thread size (R, NPT)	Tightening torque [N·m]
1/16, 1/8	3 to 5
1/4	8 to 12
3/8	15 to 20
1/2	20 to 25

2) If the fitting is tightened with excessive torque, a large amount of sealant will seep out. Remove the excess sealant.

3) Insufficient tightening may cause seal failure, or loosen the threads.

4) Reuse

(1) Normally, fittings with a sealant can be reused up to 2 to 3 times.

(2) To prevent air leakage through the sealant, remove any loose sealant stuck to the fitting by blowing air over the threaded portion.

(3) If the sealant no longer provides effective sealing, wind sealing tape over the sealant before reusing. Do not use the sealant in any form other than a tape type.

(4) Once the fitting has been tightened, backing it out to its original position often causes the sealant to become defective. Air leakage will occur.

### 5. Face seal fittings: R, NPT, G

1) Tighten fittings with sealant using the proper tightening torques in the table below.

Connection thread size (R, NPT, G)	Proper tightening torque [N·m]
1/16, 1/8	3 to 5
1/4	8 to 12
3/8	15 to 20
1/2	20 to 25

2) Insufficient tightening may cause seal failure, or loosen the threads.

3) Reuse

(1) Normally, fittings with a sealant can be reused up to 6 to 10 times.

(2) The seal ring cannot be replaced.

### 6. Uni thread fittings

1) First, tighten the threaded portion by hand, then use a proper wrench, which could be suitable for the width across flats of the hexagon body, to tighten it further at a wrench tightening angle shown below. As a reference value for the tightening torque, refer to the table below.

#### Connection Female Thread: Rc, NPT, NPTF

Uni thread size	Wrench tightening angle after hand-tightening [deg]	Tightening torque [N·m]
1/8	30 to 60	3 to 5
1/4	30 to 60	8 to 12
3/8	15 to 45	14 to 16
1/2	15 to 30	20 to 22

#### Connection Female Thread: G

Uni thread size	Wrench tightening angle after hand-tightening [deg]	Tightening torque [N·m]
1/8	30 to 45	3 to 4
1/4	15 to 30	4 to 5
3/8	15 to 30	8 to 9
1/2	15 to 30	14 to 15

2) The gasket can be reused up to 6 to 10 times. It can be replaced easily when it has sustained damage. A broken gasket can be removed by holding it and then turning it in the same direction as loosening the thread. If gasket is difficult to remove, cut it with nippers, etc. In such a case, use caution not to scratch the seat face because the seat face of 45° gasket of fitting is the sealing face.

## Chamfer Dimension for Female Thread

### ⚠ Caution

#### 1. Chamfer dimension for female thread of the connection thread M3, M5, 10-32UNF

Confirming to ISO 16030 (air pressure fluid dynamics – connection – ports and stud ends), the chamfer dimensions shown below are recommended. By chamfering as shown in the following table, machining of threads is easier and effective for burr prevention.

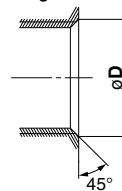

Connection thread size	Chamfer dimension øD (Recommended value) [mm]
M3	3.1 to 3.4
M5	5.1 to 5.4
10-32UNF	5.0 to 5.3

#### 2. Chamfer dimension of R and NPT thread with sealant, and Uni thread

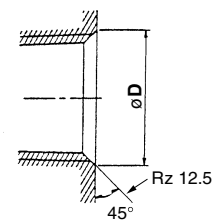

Connection thread size	Chamfer dimension øD (Recommended value)		
	G	Rc	NPT, NPTF
1/16	—	—	8.2 to 8.4
1/8	10.2 to 10.6	10.2 to 10.4	10.5 to 10.7
1/4	13.6 to 14.0	13.6 to 13.8	14.1 to 14.3
3/8	17.1 to 17.5	17.1 to 17.3	17.4 to 17.6
1/2	21.4 to 21.8	21.4 to 21.6	21.7 to 21.9

\* For Uni thread, Rz 12.5 is necessary for sealing at the chamfered part.



# Fittings & Tubing Precautions 5

Be sure to read this before handling products.

## Chamfer Dimension for Female Thread

### ⚠ Caution

#### 3. Chamfer dimension for female thread of face seal fitting (R, NPT, G)

- 1) Surface roughness of bearing surface: Rz 25 or less
- 2) Chamfer dimension:  $\phi D1$ , Seal bearing surface diameter:  $\phi D2$  (Refer to the table below.)
- 3) Female thread inclination angle:  $1^\circ$  or less
- 4) Counterbore diameter when the female thread is counterbored.:  $\phi D3$ 
  - Models with width across flats: Body width across flats x 1.1 or more
  - Models other than hexagon (Hexagon socket head male connector etc.): Body dimensions + 0.2 mm or more
- \* The width across flats and the body dimensions differ depending on the model even when the same thread size is used. Refer to the dimensions in the catalog.
- 5) If oil content or sealant is sticking to the female thread, this may cause damage of the product. Remove it before piping.

Connection thread size	Chamfer dimension $\phi D1$ [mm]	Seal bearing surface diameter $\phi D2$ [mm]
R1/8	10.2 to 10.4	12 or more
R1/4	13.6 to 13.8	17 or more
R3/8	17.1 to 17.3	21 or more
R1/2	21.4 to 21.6	27 or more
NPT1/16	8.2 to 8.4	11.11 or more
NPT1/8	10.5 to 10.7	12.7 or more
NPT1/4	14.1 to 14.3	17.46 or more
NPT3/8	17.4 to 17.6	22 or more
NPT1/2	21.7 to 21.9	28.7 or more
G1/8	10.2 to 10.6	12 or more
G1/4	13.6 to 14.0	17 or more
G3/8	17.1 to 17.5	21 or more
G1/2	21.4 to 21.8	27 or more

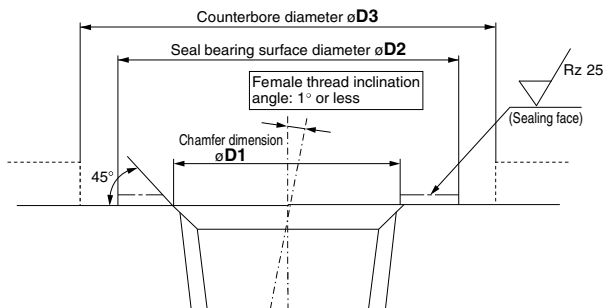

## Recommended Piping Conditions

### 1. When connecting piping to the One-touch fitting, use pipe length with sufficient margin, in accordance with the piping conditions shown in Fig. 1.

Also, when using a tying band, etc., to bind the piping together, make sure that external force does not come to bear on the fitting. (See Fig. 2.)

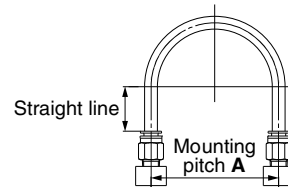

Fig. 1 Recommended piping

Unit: [mm]

Tubing size	Mounting pitch A			Straight line length
	Nylon tubing	Soft nylon tubing	Polyurethane tubing	
$\phi 2$	—	—	13 or more	10 or more
$\phi 3.2, 1/8"$	44 or more	35 or more	25 or more	16 or more
$\phi 4, 5/32"$	56 or more	44 or more	26 or more	20 or more
$\phi 3/16"$	67 or more	52 or more	38 or more	24 or more
$\phi 6$	84 or more	66 or more	39 or more	30 or more
$\phi 1/4"$	89 or more	70 or more	57 or more	32 or more
$\phi 8, 5/16"$	112 or more	88 or more	52 or more	40 or more
$\phi 10$	140 or more	110 or more	69 or more	50 or more
$\phi 3/8"$	134 or more	105 or more	69 or more	48 or more
$\phi 12$	168 or more	132 or more	88 or more	60 or more
$\phi 1/2"$	178 or more	140 or more	93 or more	64 or more
$\phi 16$	224 or more	176 or more	114 or more	80 or more

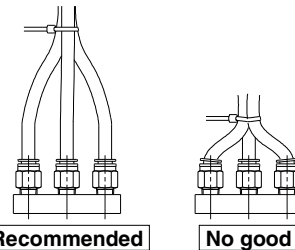

Fig. 2 When using a tying band to bind the piping together

## Tubing

### Design / Selection

### ⚠ Caution

#### 1. When using a tubing other than from SMC, be careful of the tolerance of the tubing O.D. and tubing material.

- 1) Nylon tubing Within  $\pm 0.1$  mm
- 2) Soft nylon tubing Within  $\pm 0.1$  mm
- 3) Polyurethane tubing Within  $+0.15$  mm, Within  $-0.2$  mm

Do not use the tubing which does not satisfy the specified tubing O.D. accuracy, or if the tubing has a different I.D., material, hardness, or surface roughness from those of SMC's tubing. Please consult SMC if there is anything unclear. It may cause difficulty in connecting the tubing, leakage, disconnection of the tubing, or fitting damage.

When used with tubing other than those from SMC, due to their properties, the products listed below are not subject to warranty.

KQG2, KQB2, KFG2, KF,  $\phi 2M$

#### 2. When using fittings other than those from SMC, be certain to confirm that operating conditions are such that no problems will arise.





## KQ2C Series

# Notes when Ordering Color Caps

In order to improve operability, the outside diameter of the release button has been enlarged for the **new KQ2** series. Therefore, the usable color caps will differ between pre-change and post-change products. Please contact SMC if anything is unclear.

### Applicable Sizes and Models

	Applicable tubing O.D.	Model
Metric size	ø8, ø10, ø12, ø16	All models*1
Inch size	ø1/4", ø3/8", ø1/2"	

\*1 Excluding models without release buttons

### How to Identify Release Buttons Before and After Change

The release button for both the fitting/**KQ2** and color cap/**KQ2C** after the change can be identified by the protruding mark on the left side of the **SMC** logo, and the release button before the change has no protruding mark. The same identification method is used for metric size and inch size.

- \* Along with the change of the release button, the model of the color cap/**KQ2C** is changed from **KQ2C-□A** to **KQ2C-□B**.
- \* There is no change of the model for the fitting/**KQ2**.

#### Before change



#### After change



#### Applicable color cap

##### Metric Size

Applicable tubing O.D. [mm]	Model	øD1	øD2	L	Weight [g]
ø8	<b>KQ2C-08□A</b>	12.8	9.2	2.6	0.1
ø10	<b>KQ2C-10□A</b>	15.2	11.2	2.7	0.1
ø12	<b>KQ2C-12□A</b>	17.6	13.2	2.7	0.1
ø16	<b>KQ2C-16□A</b>	22.4	17.2	3.2	0.2

□: B (Black), R (Red), YR (Orange), BR (Brown), Y (Yellow), G (Green), CB (Sky blue), GR (Gray), W (White), BU (Blue)

##### Inch Size

Applicable tubing O.D. [inch]	Model	øD1	øD2	L	Weight [g]
ø1/4	<b>KQ2C-07□A</b>	10.7	7.5	2.6	0.1
ø3/8	<b>KQ2C-11□A</b>	14.8	10.7	2.7	0.1
ø1/2	<b>KQ2C-13□A</b>	18.5	13.9	2.7	0.1

□: B (Black), R (Red), YR (Orange), BR (Brown), Y (Yellow), G (Green), CB (Sky blue), GR (Gray), W (White), BU (Blue)

#### Applicable color cap

##### Metric Size

Applicable tubing O.D. [mm]	Model	øD1	øD2	L	Weight [g]
ø8	<b>KQ2C-08□B</b>	13.6	9.2	2.6	0.1
ø10	<b>KQ2C-10□B</b>	16.2	11.2	2.7	0.1
ø12	<b>KQ2C-12□B</b>	18.8	13.2	2.7	0.2
ø16	<b>KQ2C-16□B</b>	24.2	17.2	3.2	0.3

□: B (Black), R (Red), YR (Orange), BR (Brown), Y (Yellow), G (Green), CB (Sky blue), GR (Gray), W (White), BU (Blue)

##### Inch Size

Applicable tubing O.D. [inch]	Model	øD1	øD2	L	Weight [g]
ø1/4	<b>KQ2C-07□B</b>	11.5	7.5	2.6	0.1
ø3/8	<b>KQ2C-11□B</b>	15.7	10.7	2.7	0.1
ø1/2	<b>KQ2C-13□B</b>	19.6	13.9	2.7	0.2

□: B (Black), R (Red), YR (Orange), BR (Brown), Y (Yellow), G (Green), CB (Sky blue), GR (Gray), W (White), BU (Blue)



# KQ2C Series

## Precautions for Color Caps Applicable to Products Other than the New KQ2

Please note that color cap models for products other than the **New KQ2** One-touch fittings are different.  
The table of applicable color caps is shown below.  
Please contact SMC for any questions.

**Table of Applicable Color Caps**

### Metric Size

Description	Applicable series	Applicable tubing O.D. mm	Model	øD1	øD2	L	Weight g
<b>Rectangular Multi-connector</b>	<b>KDM</b>	ø3.2	<b>KQ2C-01</b> □	9.1	4.35	2.9	0.1
		ø4	<b>KQ2C-04</b> □	10.1	5.2	2.9	0.1
		ø6	<b>KQ2C-06</b> □	12.1	7.2	2.9	0.1
		ø8	<b>KQ2C-08</b> □	14.1	9.2	2.9	0.1
<b>Multi-connector with One-touch Fittings</b>	<b>DMK</b>	ø3.2	<b>KQ2C-01A-</b> □	7.35	4.2	2.5	0.1
		ø4	<b>KQ2C-04A-</b> □	8.5	5	2.2	0.1
<b>S Couplers</b> Straight Type with One-touch Fitting KK2□-□H Bulkhead Type with One-touch Fitting KK2□-□E	<b>KK2</b> □-□H <b>KK2</b> □-□E	ø3.2	<b>KQ2C-01A-</b> □	7.35	4.2	2.5	0.1
		ø4	<b>KQ2C-04A-</b> □	8.5	5	2.2	0.1
		ø6	<b>KQ2C-06A-</b> □	10.5	7	2.2	0.1
<b>S Couplers</b> Elbow Type with One-touch Fitting	<b>KK2</b> □-23L	ø3.2	<b>KQ2C-01B-</b> □	8.8	4.2	2.5	0.1
		ø4	<b>KQ2C-04B-</b> □	9.7	5	2.2	0.1
		ø6	<b>KQ2C-06B-</b> □	12	7	2.2	0.1
<b>S Couplers</b>	<b>KK3</b>	ø4	<b>KQ2C-04</b> □	10.1	5.2	2.9	0.1
		ø6	<b>KQ2C-06</b> □	12.1	7.2	2.9	0.1
	<b>KK3, KK4</b>	ø8	<b>KQ2C-08</b> □	14.1	9.2	2.9	0.1
		ø10	<b>KQ2C-10</b> □	17.1	11.2	2.9	0.2
<b>One-touch Fittings Manifold</b>	<b>KM</b>	ø4	<b>KQ2C-04</b> □	10.1	5.2	2.9	0.1
		ø6	<b>KQ2C-06</b> □	12.1	7.2	2.9	0.1
		ø8	<b>KQ2C-08</b> □	14.1	9.2	2.9	0.1
		ø10	<b>KQ2C-10</b> □	17.1	11.2	2.9	0.2
<b>Self-seal Fittings</b> <b>Rotary One-touch Fittings</b>	<b>KC</b> <b>KS/KX</b>	ø4	<b>KQ2C-04</b> □	10.1	5.2	2.9	0.1
		ø6	<b>KQ2C-06</b> □	12.1	7.2	2.9	0.1
		ø8	<b>KQ2C-08</b> □	14.1	9.2	2.9	0.1
		ø10	<b>KQ2C-10</b> □	17.1	11.2	2.9	0.2
		ø12	<b>KQ2C-12</b> □	19.1	13.2	2.9	0.2
<b>Piping Module</b>	<b>KB</b>	ø4	<b>KQ2C-04</b> □	10.1	5.2	2.9	0.1
		ø6	<b>KQ2C-06</b> □	12.1	7.2	2.9	0.1
		ø8	<b>KQ2C-08</b> □	14.1	9.2	2.9	0.1
		ø10	<b>KQ2C-10</b> □	17.1	11.2	2.9	0.2
		ø12	<b>KQ2C-12</b> □	19.1	13.2	2.9	0.2
		ø16	<b>KQ2C-16</b> □	26.3	17.2	3.9	0.3

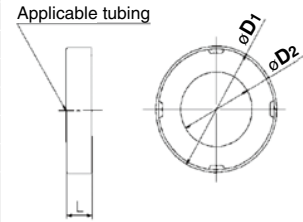

□: B (Black), R (Red), YR (Orange), BR (Brown), Y (Yellow), G (Green), CB (Sky blue), GR (Gray), W (White), BU (Blue)

### Inch Size

Description	Applicable series	Applicable tubing O.D. Inch	Model	øD1	øD2	L	Weight g
<b>Rectangular Multi-connector</b>	<b>KDM</b>	1/8"	<b>KQ2C-01</b> □	9.1	4.35	2.9	0.1
		1/4"	<b>KQ2C-07</b> □	12.6	7.5	2.9	0.1
<b>One-touch Fittings Manifold</b>	<b>KM</b>	1/4"	<b>KQ2C-07</b> □	12.6	7.5	2.9	0.1
		3/8"	<b>KQ2C-11</b> □	16.6	10.65	2.9	0.2
		1/2"	<b>KQ2C-13</b> □	20.6	1.85	2.9	0.2
<b>Rotary One-touch Fittings</b>	<b>KS</b>	1/4"	<b>KQ2C-07</b> □	12.6	7.5	2.9	0.1
		3/8"	<b>KQ2C-11</b> □	16.6	10.65	2.9	0.2

□: B (Black), R (Red), YR (Orange), BR (Brown), Y (Yellow), G (Green), CB (Sky blue), GR (Gray), W (White), BU (Blue)

## Safety Instructions

These safety instructions are intended to prevent hazardous situations and/or equipment damage. These instructions indicate the level of potential hazard with the labels of “**Caution**,” “**Warning**” or “**Danger**.” They are all important notes for safety and must be followed in addition to International Standards (ISO/IEC)\*1, and other safety regulations.

 **Caution:** Caution indicates a hazard with a low level of risk which, if not avoided, could result in minor or moderate injury.

 **Warning:** Warning indicates a hazard with a medium level of risk which, if not avoided, could result in death or serious injury.

 **Danger:** Danger indicates a hazard with a high level of risk which, if not avoided, will result in death or serious injury.

\*1) ISO 4414: Pneumatic fluid power – General rules relating to systems.  
ISO 4413: Hydraulic fluid power – General rules relating to systems.  
IEC 60204-1: Safety of machinery – Electrical equipment of machines.  
(Part 1: General requirements)  
ISO 10218-1: Manipulating industrial robots – Safety.  
etc.

### Warning

#### 1. The compatibility of the product is the responsibility of the person who designs the equipment or decides its specifications.

Since the product specified here is used under various operating conditions, its compatibility with specific equipment must be decided by the person who designs the equipment or decides its specifications based on necessary analysis and test results. The expected performance and safety assurance of the equipment will be the responsibility of the person who has determined its compatibility with the product. This person should also continuously review all specifications of the product referring to its latest catalog information, with a view to giving due consideration to any possibility of equipment failure when configuring the equipment.

#### 2. Only personnel with appropriate training should operate machinery and equipment.

The product specified here may become unsafe if handled incorrectly. The assembly, operation and maintenance of machines or equipment including our products must be performed by an operator who is appropriately trained and experienced.

#### 3. Do not service or attempt to remove product and machinery/equipment until safety is confirmed.

1. The inspection and maintenance of machinery/equipment should only be performed after measures to prevent falling or runaway of the driven objects have been confirmed.
2. When the product is to be removed, confirm that the safety measures as mentioned above are implemented and the power from any appropriate source is cut, and read and understand the specific product precautions of all relevant products carefully.
3. Before machinery/equipment is restarted, take measures to prevent unexpected operation and malfunction.

#### 4. Contact SMC beforehand and take special consideration of safety measures if the product is to be used in any of the following conditions.

1. Conditions and environments outside of the given specifications, or use outdoors or in a place exposed to direct sunlight.
2. Installation on equipment in conjunction with atomic energy, railways, air navigation, space, shipping, vehicles, military, medical treatment, combustion and recreation, or equipment in contact with food and beverages, emergency stop circuits, clutch and brake circuits in press applications, safety equipment or other applications unsuitable for the standard specifications described in the product catalog.
3. An application which could have negative effects on people, property, or animals requiring special safety analysis.
4. Use in an interlock circuit, which requires the provision of double interlock for possible failure by using a mechanical protective function, and periodical checks to confirm proper operation.

### Caution

#### 1. The product is provided for use in manufacturing industries.

The product herein described is basically provided for peaceful use in manufacturing industries.  
If considering using the product in other industries, consult SMC beforehand and exchange specifications or a contract if necessary.  
If anything is unclear, contact your nearest sales branch.

### Limited warranty and Disclaimer/ Compliance Requirements

The product used is subject to the following “Limited warranty and Disclaimer” and “Compliance Requirements”.

Read and accept them before using the product.

#### Limited warranty and Disclaimer

1. The warranty period of the product is 1 year in service or 1.5 years after the product is delivered, whichever is first.\*2)  
Also, the product may have specified durability, running distance or replacement parts. Please consult your nearest sales branch.
2. For any failure or damage reported within the warranty period which is clearly our responsibility, a replacement product or necessary parts will be provided.  
This limited warranty applies only to our product independently, and not to any other damage incurred due to the failure of the product.
3. Prior to using SMC products, please read and understand the warranty terms and disclaimers noted in the specified catalog for the particular products.

#### \*2) Vacuum pads are excluded from this 1 year warranty.

A vacuum pad is a consumable part, so it is warranted for a year after it is delivered.  
Also, even within the warranty period, the wear of a product due to the use of the vacuum pad or failure due to the deterioration of rubber material are not covered by the limited warranty.

#### Compliance Requirements

1. The use of SMC products with production equipment for the manufacture of weapons of mass destruction (WMD) or any other weapon is strictly prohibited.
2. The exports of SMC products or technology from one country to another are governed by the relevant security laws and regulations of the countries involved in the transaction. Prior to the shipment of a SMC product to another country, assure that all local rules governing that export are known and followed.

### Caution

#### SMC products are not intended for use as instruments for legal metrology.

Measurement instruments that SMC manufactures or sells have not been qualified by type approval tests relevant to the metrology (measurement) laws of each country. Therefore, SMC products cannot be used for business or certification ordained by the metrology (measurement) laws of each country.

#### Revision History

**Edition B** \* Correction of errors in dimensions  
\* Pages 5, 6, 7, 8, 9, 10, 11, 12, 13, 14, 15, 16, 18, 19, 20, 22, 24, 25, 26, 27, 28, 29, 38, 39, 41, 49, 52, 53, 60, 68, 70  
\* Addition of proof pressure conditions  
\* Change of tightening conditions (Torque, Number of rotations)  
\* Addition of color cap

\* Addition of made to order (White vaseline, Black body)  
\* Addition of Clean Series RS  
**Edition C** \* Addition of face seal  
\* Correction of errors in dimensions  
Pages 11, 13, 15, 16, 23, 26, 40, 46, 51, 60, 61, 104, 105  
\* Deletion of the note about “Applicable Tubing”  
Pages 1, 33, 57, 65, 101, 109

\* Number of pages increased from 88 to 124 RZ  
**Edition D** \* Addition of oval type release button  
\* Addition of products with interchangeable effective area (KQ2□□-□□□□)  
\* Addition of made to order  
\* Number of pages increased from 124 to 224 UX

## Safety Instructions

Be sure to read the “Handling Precautions for SMC Products” (M-E03-3) and “Operation Manual” before use.