

Low voltage

# Acti 9

the efficiency you deserve

Catalogue  
09/2013

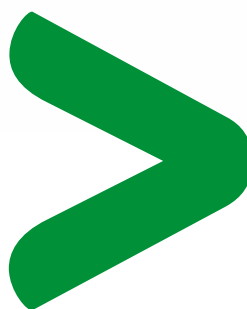

**General****Principle of catalogue numbers, protection (Acti 9)**

CA901009E 1

**Circuit protection**

Choice of circuit protective devices

CA901011E 2

Circuit breaker panorama

CA901000E 4

**Neutral breaking circuit breakers**

i DPN, DT40, DT60, C40 (Clario, Libro, Prodis)

CA901012E 14

**Circuit breakers up to 63 A**

iC60a

CA901010E 26

iC60N

CA901002E 31

iC60N double terminals

CA901019E 40

iC60H

CA901003E 45

iC60H double terminals

CA901020E 54

iC60L

CA901004E 58

iK60 (B curve)

CA901006E 61

iK60 (C curve)

CA901007E 64

iK60 Biconnect

CA901027E 70

**Circuit breakers up to 125 A**

C 120a, N, H (RSA)

CA901017E 73

C 120N

CA901015E 78

C 120H

CA901016E 82

**High performance circuit breakers**

NG125a

CM901027E 85

NG125N

CM901028E 89

NG125H

CM901029E 95

NG125L

CM901030E 99

**Direct current circuit breakers**

C60H-DC

CA901024E 105

C60PV-DC

CA901031E 108

C60NA-DC

CA901032E 112

SW60-DC

CA901030E 116

**Motor protection circuit breakers**

P25M

CM901026E 120

iC60LMA

CA901005E 125

NG125LMA

CM901031E 128

**Fuses**

STI

CM901033E 132

DO fuse disconnectors switches (projet Dido)

CA901035E 135

Fuse holder with indicator light SBI

CM901034E 137

**Residual current devices**

Choice of earth leakage protection devices

CA902000E 140

Overview of the earth leakage protection product range

CA902011E 142

**Residual current circuit breakers**

iID

CA902002E 145

iID double terminals

CA902018E 161

iID K

CA902007E 167

iID K biconnect

CA902027E 171

IDc, ITG40, ID C40 (Clario, Libro, Prodis)

CA902012E 173

RCCB-ID 125 A

CM902001E 178

RCCB-ID type B

CM902002E 180

**Add-on residual current devices for circuit breakers**

Vigi iC60

CA902005E 182

Vigi iC60 double terminals

CA902019E 193

Vigi C120

CA902016E 199

Vigi NG125

CM902008E 204

Residual current devices

iDPN Vigi

CA902026E 214

i DPN Vigi, Vigi i DPN, Vigi TG40, Vigi TG60, DT40 Vigi, Vigi DT40, Vigi C40, C40 Vigi (Clario, Libro, Prodis)

CA902013E 217

DPNa Vigi, DPN N Vigi

CA902014E 227

DPN Vigi K

CA902032E 231

SPN N Vigi

CA902017E 233

DPN N Vigi

CA902037E 235

REDs, REDtest

CM902017E 237

**Load protection (surge arrester)****LV surge arresters**

Choice of surge arresters

CA903010E 244

iPRF1 - PRF1 - PRD1

CA903005E 248

iPF

CA903001E 254

iPRD Acti 9

CA903008E 258

iPRD (white product)

CA903002E 264

iQuick PRD

CA903003E 268

iQuick PF

CA903004E 271

**Surge arresters for telephon and informatic networks**

iPRC/iPRI

CA903006E 273

**Surge arresters for photovoltaic installations**

iPRD-DC PV (white product)

CA903007E 275

iPRD-PV-DC

CA903009E 278

**Disconnection****Switch-disconnectors**

iSW Acti 9

CA904027E 282

SW Biconnect switches

CA904030E 288

**Trip switch-disconnectors**

iSW-NA

CA904013E 290

NG125NA

CM901035E 292

## Install, connection, power distribution

### Accessorisation/Auxiliarisation

Accessories / Auxiliarisation iC60, iID, iSW-NA, Reflex iC60, RCA, ARA  
Accessories and auxiliaries for C120, Vigi C120, DPN, C60H-DC devices  
Accessories and auxiliaries for NG125 devices

### Circuit breakers and residual current devices accessories

Accessories for iC60, iID, iSW-NA, Reflex iC60, RCA, ARA  
Accessories for DT60

Accessories for C120, DPN, DPN Vigi, C60H-DC devices

Accessories for NG125 devices

### Comb busbar and devices feeders

Lineryg FH et FV: Horizontal and vertical comb busbars

Lineryg DX : Quick distribution blocks

Lineryg FM: Quick device feeders

Lineryg DS: Devices feeders

## Supervision and switchboard control

### Acti 9 control system

Smartlink Acti 9

### Monitoring and control of protections

#### Indication and tripping

Electrical auxiliaries for iC60, iID, iSW-NA, RCA, ARA

Electrical auxiliaries for C120, DPN, DPN Vigi, ID, C60H-DC devices

Electrical auxiliaries for NG125 devices

#### Remote control

RCA remote controls for iC60 circuit breakers

#### Automatic reclosers

ARA automatic reclosers for iC60 and iID

## Electrical circuit control

### Manual control

iPB pushbuttons

iSSW linear switches

DIN rail selector switches iCMB, iCMD, iCME, iCMC, iCMV and iCMA

Button holders

### Electrical control

Reflex iC60 integrated control circuit breakers

iCT contactors

iTL impulse relays

TL impulse relays (Clario, Libro, Prodis)

CT contactors (Clario, Libro, Prodis)

TL+ impulse relays

CT+ contactors

## Indication

### Indicators

iLL indicator lights

iSO bells and iRO buzzers

iTR transformers

## Lighting, time and energy management

Relays iRTA, iRTB, iRTC, iRTH, iRTL, iRTMF, iRBN, iRTBT, iRLI, iERL, iRCP, iRCI, iRCU, iRCC

CDS load-shedding

Modular iPC power sockets

Kilowatt-hour meters iEM, iME

## Complementary technical information

400 Hz network

Influence of ambient temperature

Dissipated power, Impedance and Voltage drop

Resistance to environmental conditions

### Circuit protections

Tripping curves

Short-circuit current limiting

Cascading

Protection discrimination

Circuit breakers for direct current applications

Direct current distribution

### Motor protections

Motor circuit protection and contactor combination

### Photovoltaic

Examples of installation architectures

### Acti 9 Smartlink

Acti 9 Smartlink installation

### Earth leakage protections

Routine operating checks

Response time of high-sensitivity residual current devices

Response time of medium-sensitivity residual current devices

Electrical and electromagnetic interference

Co-ordination

DCP Vigi RCBO

### Fuses

SBI/STI curves

### Impulse relays, contactors

iTL impulse relays and iCT contactors, choice of rating according to load type

### Auxiliaries

Auxiliary indicating contacts for Acti 9 protective devices

Auxiliary trip units for Acti 9 protective devices

Combination electrical auxiliaries for iC60, iID, iSW-NA, ARA and RCA

## Twilight and time switches, timers, thermostats

IC twilight switches

IHP, ITM time switches

MIN timers

STD, STU dimmers

TH4, TH7, THP1, THP2 thermostats

CA907000E	298
CA907013E	305
CM907004E	311
CA907001E	312
CA907011E	318
CA907012E	320
CM907006E	324
LIN001	326
LIN003	334
LIN022	336
CA907023E	338
CA907019E	341
CA907002E	347
CA907008E	355
CM907005E	361
CA904011E	365
CA904010E	370
CA904003E	375
CA904004E	376
CA904024E	378
CA907007E	381
CA904012E	382
CA904007E	387
CA904008E	404
CA904020E	417
CA904021E	423
CA904018E	429
CA904019E	431
CA904006E	433
CA904014E	434
CA904015E	435
CA904022E	438
CA904023E	447
CA904017E	453
CA904009E	456
CA908005E	460
CA908007E	462
CA908009E	470
CA908027E	472
CA908024E	474
CA908025E	483
557E4200	501
557E4300	539
557E4305	546
557E4310	580
557E4330	587
CA908036E	607
CA908032E	609
CA908006E	627
CA908022E	653
CA908035E	654
CA908033E	660
CA908012E	663
CA908013E	666
CA908018E	667
CA908015E	671
CA908023E	674
CM902006E	681
CM908003E	691
CA908026E	695
CA908028E	700
CA908029E	703
CA908030E	710
LSB02323EN	712
LSB02322EN	720
LSB02321EN	735
LSB02325EN	739
LSB02324EN	744

## iID, iC60, Vigi iC60, Reflex iC60, switches

A9 R 15 2 63

Range	Family	Code	Internal code	Poles	Code	Rating (A)	Code
Acti 9 (A9)	iID	R		0	0	0	00
	Vigi iC60	V		1P	1	0.5	70
	iC60	F		<b>2P</b>	<b>2</b>	0.75	71
	iK60	K		3P	3	1	01
	Auxiliaries and accessories	A		4P	4	1.6	72
	Switches	S		1N	5	2	02
	Reflex iC60	C		1P+N	6	2.5	73
			3P+N	7	3	03	
					4		04
					6		06
					6.3		76
					8		08
					10		10
					12.5		82
					13		13
					16		16
					20		20
					25		25
					32		32
					40		40
					50		50
					<b>63</b>		<b>63</b>
					80		80
					100		91
					125		92

## Comb busbar and comb busbar accessories

A9 X P H 4 12

Range	Family	Code	Type	Type of installation	Number of poles	Dimensioning			
Acti 9 (A9)	Comb busbar	X	Comb busbar		1P	1	Comb busbar		
			Fork teeth	F	Horizontal		H	Number of 18 mm modules (approximately)	
			Pin teeth	P			2P	2	Accessories
			Auxiliarisable	A			3P		Number of pieces per cat. no.
			Accessories				4P		4
			End-piece	E	Double terminals	D	4P balanced, with neutral	5	
			Tooth cover	T	Single terminal	M	3P balanced for single-poles	6	
			Connector	C					



Protection of electrical connections against short circuits and overloads



Protection of loads against overloads



Protection of control devices



Protection for people against indirect contacts in IT and TN earthing systems

- Circuit breakers can:
  - break a faulty electrical circuit (short-circuit, overload, insulation fault), to prevent fires,
  - protect control devices,
  - increase the service life of the installation, thanks to its ability to limit the short-circuit current (see module CA908025),
  - in IT and TN systems, they ensure personal protection against electrocution in the event of indirect contacts.
- The choice of circuit breakers must be optimised to provide absolute protection while ensuring continuity of service.
- Although circuit breakers are sometimes used as control units, it is recommended to install separate control devices which are more suitable for frequent switching operations (switch, contactor, impulse relay).

## Choice of protective circuit breakers

This depends on several criteria:

- prospective short-circuit current
- max. voltage rating
- planned amperage for the circuit to be protected
- nature and cross section of cables
- ambient temperature (possible derating)
- the network and neutral system, which determine the number of poles of the protective circuit breaker installed on their power supply circuit and the tripping curve
- coordination with the other electrical devices (protection, discrimination, cascading).

## Choice of breaking capacity

- The breaking capacity must be greater than or equal to the prospective short-circuit current (Isc) upstream of the circuit-breaker (Isc depends on the length, type of conductor and cross section of the cable and the power of the source).
- However, in the event of use in combination with an upstream circuit-breaker limiting the current, this breaking capacity can possibly be reduced (cascading, see module 557E4200).

## Choice of rating

- The rating (In) is chosen above all to protect the electrical connections:
  - for cables: it is chosen according to the cross section and type of conductor,
  - for Canalis prefabricated busbar trunking: it must be simply less than or equal to the rating of the busbar trunking.
- The rating should be greater than the nominal current of the loads.

## Choice of tripping curve

The tripping curve makes the protection more or less sensitive to:

- the inrush current at power up
- the overload current.

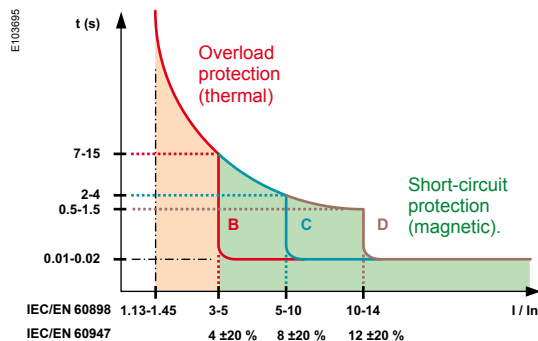



### Tripping thresholds (x In)

Curves	IEC /EN 60898	IEC/EN 60947-2
B	Between 3 In and 5 In	4 ± 20 %
C	Between 5 In and 10 In	8 ± 20 %
D or K	Between 10 In and 14 In	12 ± 20 %
MA	-	12 ± 20 %
Z	-	3 ± 20 %

- To prevent nuisance tripping, it may be advisable to choose a less sensitive curve, e.g. change from B to C (tripping curves, see module CA908024).

## Selection guide

### Circuit breakers

Type		iK60N		iC60N			
							
Standard		IEC/EN 60898-1		IEC/EN 60947-2, 60898-1			
Quality label		Country approval pictogram		Country approval pictogram			
Number of poles		1P, 1P+N   2, 3, 4P		1P, 1P+N		2, 3, 4P	
Add-on residual current devices (Vigi)		-		■			
Auxiliaries for remote tripping and indication		-		■			
<b>Electrical characteristics</b>							
Curves		B, C		B, C, D			
Ratings (A)		In 1 to 63		0.5 to 63 (1 to 63 in DC)			
Maximum operational voltage (V)		Ue AC (50/60 Hz) 230/400 DC -		240/415, 440 250			
Minimum operational voltage (V)		Ue AC (50/60 Hz) - DC -		12 12			
Insulation voltage (V AC)		Ui 400		500			
Rated impulse withstand voltage (kV)		Uimp 4		6			
Limitation class 40 A (EN 60898)		3		3			
<b>Breaking capacity</b>							
IEC/EN 60898 (A)		Icn 240/415 V - 230/400 V		6000		6000	
<b>AC-Breaking capacity</b>		Ue (50/60 Hz)		1P, 1P+N		2, 3, 4P	
Ratings (A)		In 1 to 63		0.5 to 4 A		6 to 63 A	
IEC 60947-2 (kA)		Icu 12...60 V		-		50	
		12...133 V		-		36	
		100...133 V		-		50	
		220...240 V		-		20	
		380...415 V		-		50	
		440 V		-		10	
		Ics		-		25	
				100 % of Icu		75 % of Icu	
				100 % of Icu		75 % of Icu	
<b>DC-Breaking capacity</b>		Ue DC		1P, 1P+N		2, 3, 4P	
IEC 60947-2 (kA)		Icu 12...60 V (1P)		-		15	
		≤ 72 V (1P)		-		10	
		≤ 125 V (2P)		-		10	
		≤ 180 V (3P)		-		10	
		≤ 250 V (4P)		-		10	
		Ics		-		100 % of Icu	
<b>Other characteristics</b>							
Suitable for industrial isolation according to IEC/EN 60947-2		-		■			
Reference temperature IEC/EN 60947-2		-		50°C			
Fault tripping indication		-		Visi-trip window			
Positive contact indication		-		■			
Fast closing		-		■			
Degree of protection		IP Device only IP20 Device in modular enclosure IP40		IP20 IP40		IP20 IP40	
Insulation class II		CA901006 and CA901007		CA901002			
<b>For more detail, see module</b>							
Accessories		-		CA907000 and CA907001			
Auxiliaries		-		CA907000 and CA907002			
Add-on residual current devices (Vigi)		-		CA902005			



Schneider Electric's range of circuit breakers consists of different products (A, B, C) to enable it to be the most competitive range possible in each country, allowing for the special characteristics of each market:

- usual installation procedure
- price
- accreditations by local bodies.

**Variants**

Offers		Pages
Offer A	Catalogue numbers	32
Offer B	Catalogue numbers	34
Offer C	Catalogue numbers	36
Common pages		38

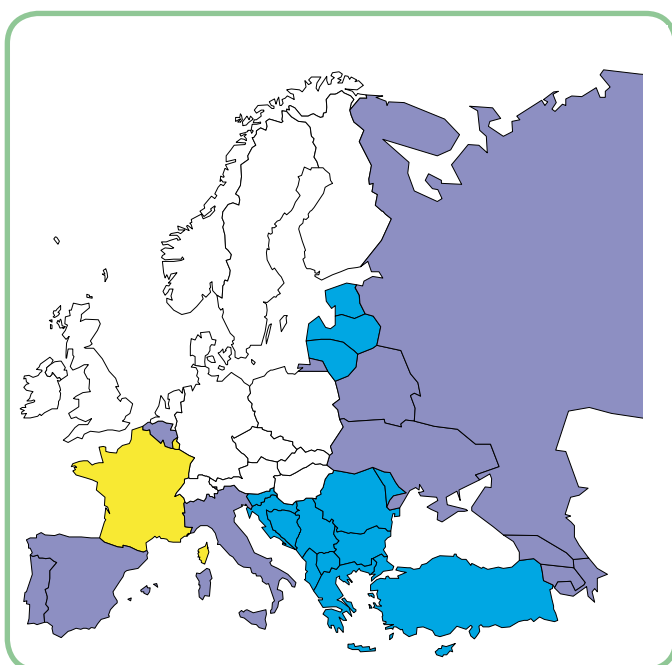

*Only the product range to be marketed in your country and validated by the local product manager, in agreement with his Final Distribution (FD) partner should be retained. The others will be removed before publication.*

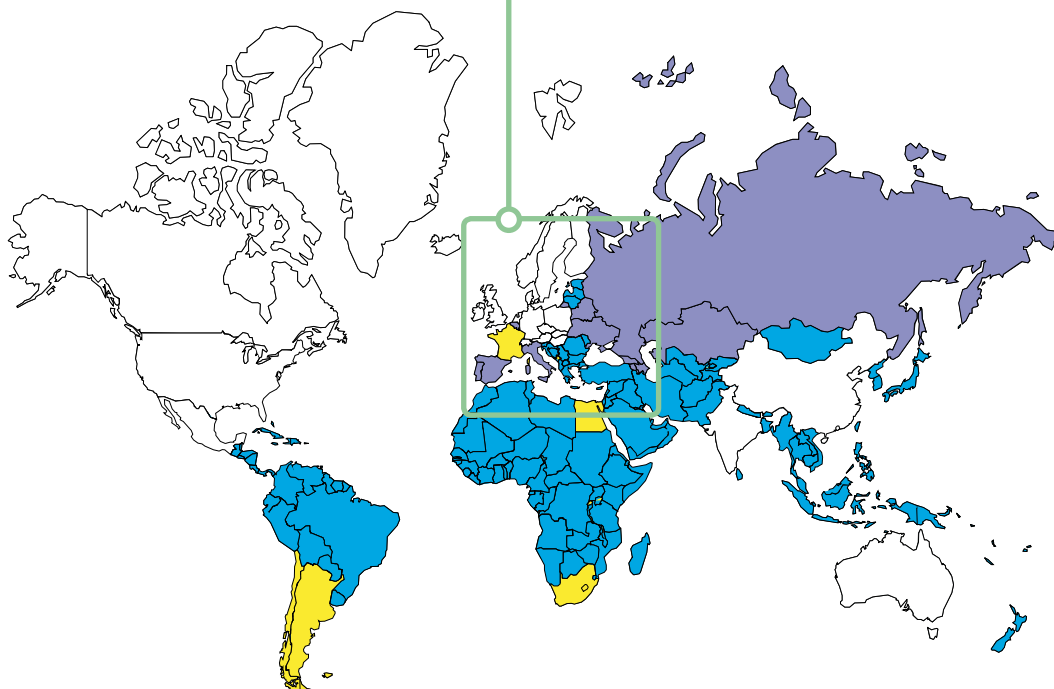

# iC60N circuit breakers (curve B, C, D)



## IEC/EN 60947-2 IEC/EN 60898-1

- iC60N circuit breakers are multi-standard circuit breakers which combine the following functions:
  - circuit protection against short-circuit currents,
  - circuit protection against overload currents,
  - suitable for industrial isolation according to IEC/EN 60947-2, standard.
  - fault tripping indication by a red mechanical indicator in circuit breaker front face.



### Alternating current (AC) 50/60 Hz

Breaking capacity (Icu) according to IEC/EN 60947-2	Voltage (Ue)				Service breaking capacity (Ics)
	12 to 133 V	220 to 240 V	380 to 415 V	440 V	
Ph/Ph (2P, 3P, 4P)	12 to 60 V	100 to 133 V	220 to 240 V	-	100 % of Icu
Ph/N (1P, 2P, 3P)	50 kA	50 kA	50 kA	25 kA	
Rating (In) 0.5 to 4 A	50 kA	50 kA	50 kA	25 kA	75 % of Icu
6 to 63 A	36 kA	20 kA	10 kA	6 kA	

Breaking capacity (Icn) according to IEC/EN 60898-1	Voltage (Ue)	
	Ph/Ph	Ph/N
Rating (In) 0.5 to 63 A	400 V	230 V
	6000 A	

### Direct current (DC)

Breaking capacity (Icu) according to IEC/EN 60947-2	Voltage (Ue)					Service breaking capacity (Ics)
	Between +/-	12 to 60 V	≤ 72 V	≤ 125 V	≤ 180 V	
Number of poles	1P	2P	3P	4P		100 % of Icu
Rating (In) 1 to 63 A	15 kA	10 kA	10 kA	10 kA	10 kA	

## Catalogue numbers

iC60N circuit breaker						
Type	1P			1P+N		
Auxiliaries	Remote tripping and indication, module CA907000 and CA907002			Remote tripping and indication, module CA907000 and CA907002		
Vigi iC60	Vigi iC60 add-on residual current device, module CA902005			Vigi iC60 add-on residual current device, module CA902005		
Rating (In)	Curve			Curve		
	B	C	D <sup>(1)</sup>	B	C	D <sup>(1)</sup>
0.5 A <sup>(1)</sup>	A9F73170	A9F74170	A9F75170	A9F73670	A9F74670	A9F75670
1 A <sup>(1)</sup>	A9F73101	A9F74101	A9F75101	A9F73601	A9F74601	A9F75601
2 A <sup>(1)</sup>	A9F73102	A9F74102	A9F75102	A9F73602	A9F74602	A9F75602
3 A <sup>(1)</sup>	A9F73103	A9F74103	A9F75103	A9F73603	A9F74603	A9F75603
4 A <sup>(1)</sup>	A9F73104	A9F74104	A9F75104	A9F73604	A9F74604	A9F75604
6 A	A9F76106	A9F77106	A9F75106	A9F76606	A9F77606	A9F75606
10 A	A9F76110	A9F77110	A9F75110	A9F76610	A9F77610	A9F75610
13 A <sup>(1)</sup>	A9F73113	A9F74113	A9F75113	A9F73613	A9F74613	A9F75613
16 A	A9F76116	A9F77116	A9F75116	A9F76616	A9F77616	A9F75616
20 A	A9F76120	A9F77120	A9F75120	A9F76620	A9F77620	A9F75620
25 A	A9F76125	A9F77125	A9F75125	A9F76625	A9F77625	A9F75625
32 A	A9F76132	A9F77132	A9F75132	A9F76632	A9F77632	A9F75632
40 A	A9F76140	A9F77140	A9F75140	A9F76640	A9F77640	A9F75640
50 A	A9F76150	A9F77150	A9F75150	A9F76650	A9F77650	A9F75650
63 A	A9F76163	A9F77163	A9F75163	A9F76663	A9F77663	A9F75663
Width in 9-mm modules	2			4		
Accessories	Module CA907000 and CA907001			Module CA907000 and CA907001		

(1) VDE approved only.



# iC60N circuit breakers (curve B, C, D) (cont.)

PB10434-40

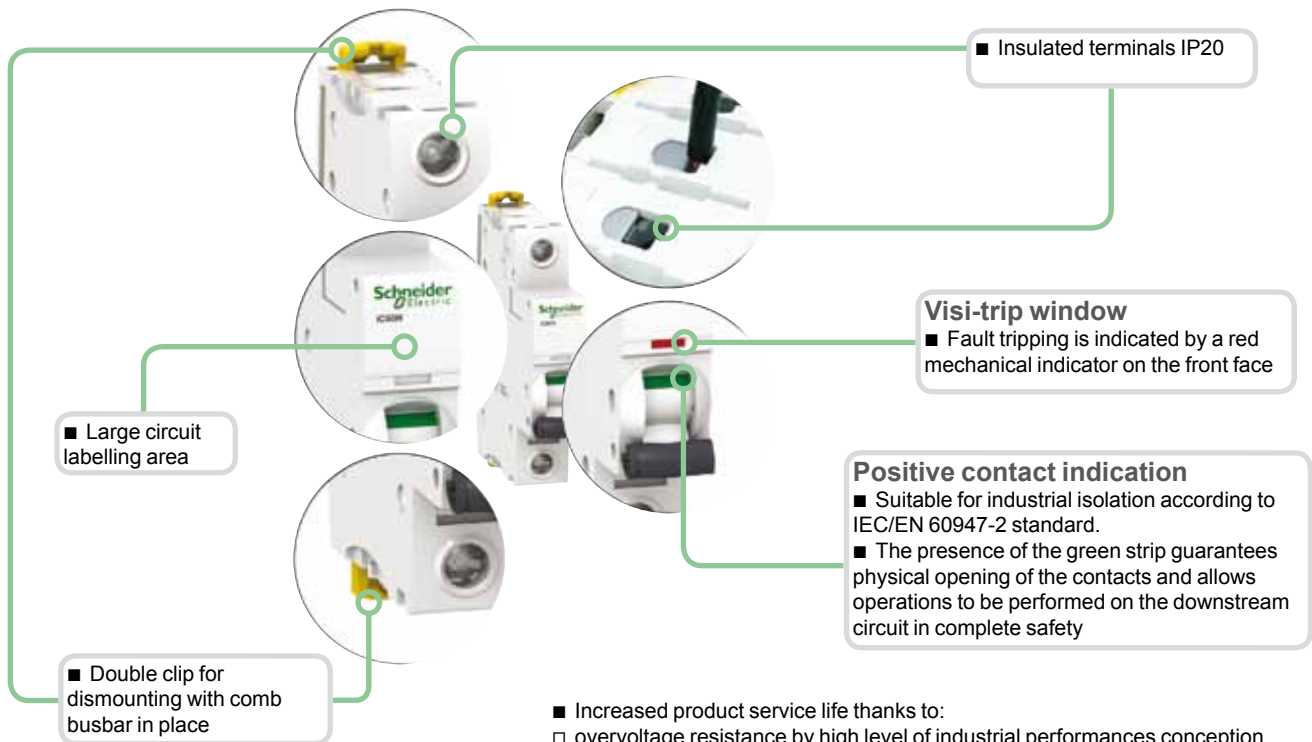

- Increased product service life thanks to:
  - overvoltage resistance by high level of industrial performances conception (pollution degree, rated impulse withstand voltage and insulation voltage),
  - high performance limitation (see limitation curves),
  - fast closing independent of the speed of actuation of the toggle.
- Remote indication, open/closed/tripped, by optional auxiliary contacts.
- Top or bottom electrical feeding.

	2P			3P			4P		
E45094									
	Remote tripping and indication, module CA907000 and CA907002			Remote tripping and indication, module CA907000 and CA907002			Remote tripping and indication, module CA907000 and CA907002		
	Vigi iC60 add-on residual current device, module CA902005			Vigi iC60 add-on residual current device, module CA902005			Vigi iC60 add-on residual current device, module CA902005		
	Curve			Curve			Curve		
	B	C	D <sup>(1)</sup>	B	C	D <sup>(1)</sup>	B	C	D <sup>(1)</sup>
	A9F73270	A9F74270	A9F75270	A9F73370	A9F74370	A9F75370	A9F73470	A9F74470	A9F75470
	A9F73201	A9F74201	A9F75201	A9F73301	A9F74301	A9F75301	A9F73401	A9F74401	A9F75401
	A9F73202	A9F74202	A9F75202	A9F73302	A9F74302	A9F75302	A9F73402	A9F74402	A9F75402
	A9F73203	A9F74203	A9F75203	A9F73303	A9F74303	A9F75303	A9F73403	A9F74403	A9F75403
	A9F73204	A9F74204	A9F75204	A9F73304	A9F74304	A9F75304	A9F73404	A9F74404	A9F75404
	A9F76206	A9F77206	A9F75206	A9F76306	A9F77306	A9F75306	A9F76406	A9F77406	A9F75406
	A9F76210	A9F77210	A9F75210	A9F76310	A9F77310	A9F75310	A9F76410	A9F77410	A9F75410
	A9F73213	A9F74213	A9F75213	A9F73313	A9F74313	A9F75313	A9F73413	A9F74413	A9F75413
	A9F76216	A9F77216	A9F75216	A9F76316	A9F77316	A9F75316	A9F76416	A9F77416	A9F75416
	A9F76220	A9F77220	A9F75220	A9F76320	A9F77320	A9F75320	A9F76420	A9F77420	A9F75420
	A9F76225	A9F77225	A9F75225	A9F76325	A9F77325	A9F75325	A9F76425	A9F77425	A9F75425
	A9F76232	A9F77232	A9F75232	A9F76332	A9F77332	A9F75332	A9F76432	A9F77432	A9F75432
	A9F76240	A9F77240	A9F75240	A9F76340	A9F77340	A9F75340	A9F76440	A9F77440	A9F75440
	A9F76250	A9F77250	A9F75250	A9F76350	A9F77350	A9F75350	A9F76450	A9F77450	A9F75450
	A9F76263	A9F77263	A9F75263	A9F76363	A9F77363	A9F75363	A9F76463	A9F77463	A9F75463
	4	Module CA907000 and CA907001		6	Module CA907000 and CA907001		8	Module CA907000 and CA907001	

# iC60N circuit breakers (curve B, C, D)

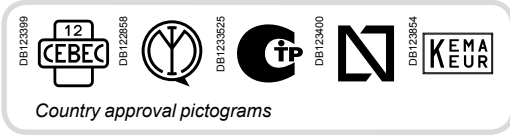

IEC/EN 60947-2  
IEC/EN 60898-1

- iC60N circuit breakers are multi-standard circuit breakers which combine the following functions:
  - circuit protection against short-circuit currents,
  - circuit protection against overload currents,
  - suitable for industrial isolation according to IEC/EN 60947-2, standard.
  - fault tripping indication by a red mechanical indicator in circuit breaker front face.



### Alternating current (AC) 50/60 Hz

Breaking capacity (Icu) according to IEC/EN 60947-2	Voltage (Ue)				Service breaking capacity (Ics)
	12 to 133 V	220 to 240 V	380 to 415 V	440 V	
Ph/Ph (2P, 3P, 4P)	12 to 133 V	220 to 240 V	380 to 415 V	440 V	100 % of Icu
Ph/N (1P, 2P)	12 to 60 V	100 to 133 V	220 to 240 V	-	
Rating (In) 0.5 to 4 A	50 kA	50 kA	50 kA	25 kA	75 % of Icu
6 to 63 A	36 kA	20 kA	10 kA	6 kA	

Breaking capacity (Icn) according to IEC/EN 60898-1	
Ph/Ph	Voltage (Ue)
Ph/Ph	400 V
Ph/N	230 V
Rating (In) 0.5 to 63 A	6000 A

### Direct current (DC)

Breaking capacity (Icu) according to IEC/EN 60947-2	Voltage (Ue)					Service breaking capacity (Ics)
	Between +/-	12 to 60 V	≤ 72 V	≤ 125 V	≤ 180 V	
Number of poles	1P	2P	3P	4P		100 % of Icu
Rating (In) 1 to 63 A	15 kA	10 kA	10 kA	10 kA	10 kA	

## Catalogue numbers

### iC60N circuit breaker

Type	1P	1P+N
Auxiliaries	Remote tripping and indication, module CA907000 and CA907002	Remote tripping and indication, module CA907000 and CA907002
Vigi iC60	Vigi iC60 add-on residual current device, module CA902005	Vigi iC60 add-on residual current device, module CA902005
Rating (In)	Curve	Curve
	B   C   D <sup>(1)</sup>	B   C   D <sup>(1)</sup>
0.5 A <sup>(1)</sup>	A9F73170   A9F74170   A9F75170	A9F73670   A9F74670   A9F75670
1 A <sup>(1)</sup>	A9F73101   A9F74101   A9F75101	A9F73601   A9F74601   A9F75601
2 A <sup>(1)</sup>	A9F73102   A9F74102   A9F75102	A9F73602   A9F74602   A9F75602
3 A <sup>(1)</sup>	A9F73103   A9F74103   A9F75103	A9F73603   A9F74603   A9F75603
4 A <sup>(1)</sup>	A9F73104   A9F74104   A9F75104	A9F73604   A9F74604   A9F75604
6 A	A9F78106   A9F79106   A9F75106	A9F78606   A9F79606   A9F75606
10 A	A9F78110   A9F79110   A9F75110	A9F78610   A9F79610   A9F75610
13 A <sup>(1)</sup>	A9F73113   A9F74113   A9F75113	A9F73613   A9F74613   A9F75613
16 A	A9F78116   A9F79116   A9F75116	A9F78616   A9F79616   A9F75616
20 A	A9F78120   A9F79120   A9F75120	A9F78620   A9F79620   A9F75620
25 A	A9F78125   A9F79125   A9F75125	A9F78625   A9F79625   A9F75625
32 A	A9F78132   A9F79132   A9F75132	A9F78632   A9F79632   A9F75632
40 A	A9F78140   A9F79140   A9F75140	A9F78640   A9F79640   A9F75640
50 A	A9F78150   A9F79150   A9F75150	A9F78650   A9F79650   A9F75650
63 A	A9F78163   A9F79163   A9F75163	A9F78663   A9F79663   A9F75663
Width in 9-mm modules	2	4
Accessories	Module CA907000 and CA907001	Module CA907000 and CA907001

(1) VDE approved only.

# iC60N circuit breakers (curve B, C, D) (cont.)

PB104434-40

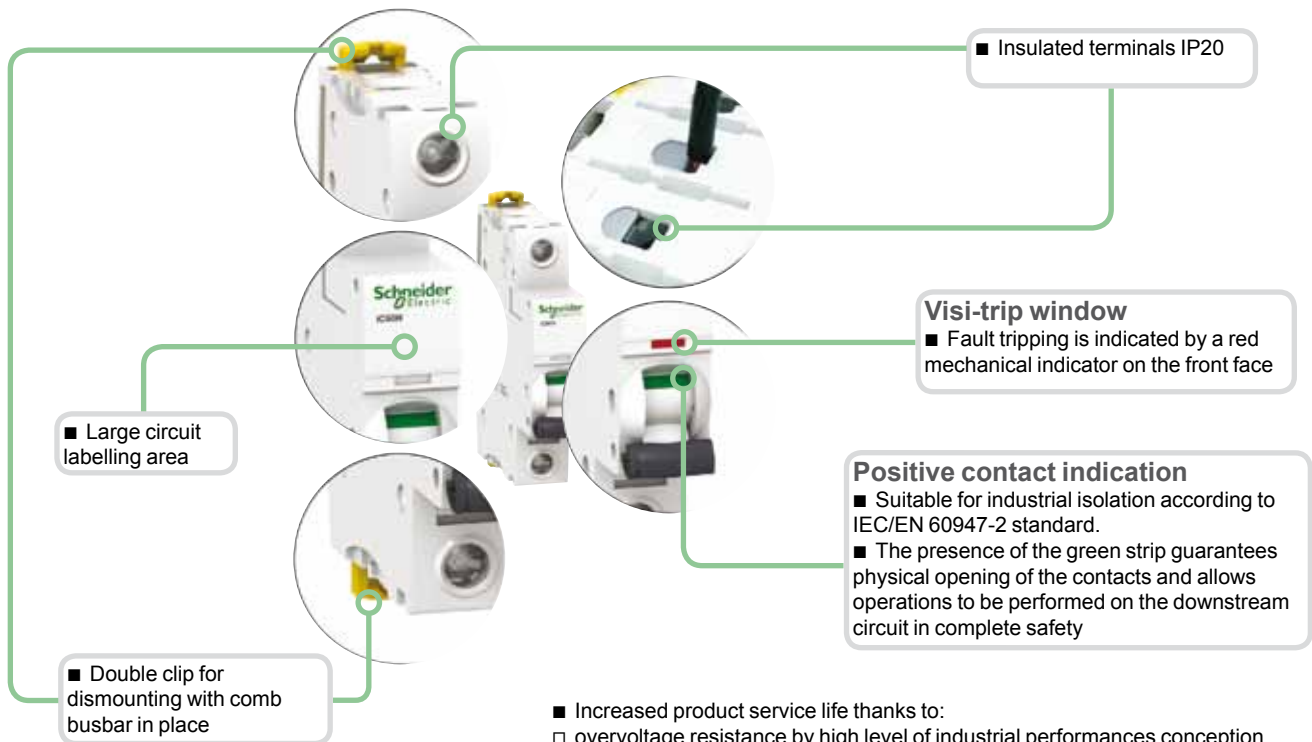

- Increased product service life thanks to:
  - overvoltage resistance by high level of industrial performances conception (pollution degree, rated impulse withstand voltage and insulation voltage),
  - high performance limitation (see limitation curves),
  - fast closing independent of the speed of actuation of the toggle.
- Remote indication, open/closed/tripped, by optional auxiliary contacts.
- Top or bottom electrical feeding.

2P				3P			4P		
E46094				E46095			E46097		
Remote tripping and indication, module CA907000 and CA907002				Remote tripping and indication, module CA907000 and CA907002			Remote tripping and indication, module CA907000 and CA907002		
Vigi iC60 add-on residual current device, module CA902005				Vigi iC60 add-on residual current device, module CA902005			Vigi iC60 add-on residual current device, module CA902005		
Curve				Curve			Curve		
B      C      D <sup>(1)</sup>				B      C      D <sup>(1)</sup>			B      C      D <sup>(1)</sup>		
A9F73270	A9F74270	A9F75270	A9F73370	A9F74370	A9F75370	A9F73470	A9F74470	A9F75470	
A9F73201	A9F74201	A9F75201	A9F73301	A9F74301	A9F75301	A9F73401	A9F74401	A9F75401	
A9F73202	A9F74202	A9F75202	A9F73302	A9F74302	A9F75302	A9F73402	A9F74402	A9F75402	
A9F73203	A9F74203	A9F75203	A9F73303	A9F74303	A9F75303	A9F73403	A9F74403	A9F75403	
A9F73204	A9F74204	A9F75204	A9F73304	A9F74304	A9F75304	A9F73404	A9F74404	A9F75404	
A9F78206	A9F79206	A9F75206	A9F78306	A9F79306	A9F75306	A9F78406	A9F79406	A9F75406	
A9F78210	A9F79210	A9F75210	A9F78310	A9F79310	A9F75310	A9F78410	A9F79410	A9F75410	
A9F73213	A9F74213	A9F75213	A9F73313	A9F74313	A9F75313	A9F73413	A9F74413	A9F75413	
A9F78216	A9F79216	A9F75216	A9F78316	A9F79316	A9F75316	A9F78416	A9F79416	A9F75416	
A9F78220	A9F79220	A9F75220	A9F78320	A9F79320	A9F75320	A9F78420	A9F79420	A9F75420	
A9F78225	A9F79225	A9F75225	A9F78325	A9F79325	A9F75325	A9F78425	A9F79425	A9F75425	
A9F78232	A9F79232	A9F75232	A9F78332	A9F79332	A9F75332	A9F78432	A9F79432	A9F75432	
A9F78240	A9F79240	A9F75240	A9F78340	A9F79340	A9F75340	A9F78440	A9F79440	A9F75440	
A9F78250	A9F79250	A9F75250	A9F78350	A9F79350	A9F75350	A9F78450	A9F79450	A9F75450	
A9F78263	A9F79263	A9F75263	A9F78363	A9F79363	A9F75363	A9F78463	A9F79463	A9F75463	
4				6			8		
Module CA907000 and CA907001				Module CA907000 and CA907001			Module CA907000 and CA907001		

# iC60N circuit breakers (curve B, C, D)



IEC/EN 60947-2  
IEC/EN 60898-1

- iC60N circuit breakers are multi-standard circuit breakers which combine the following functions:
  - circuit protection against short-circuit currents,
  - circuit protection against overload currents,
  - suitable for industrial isolation according to IEC/EN 60947-2, standard.
  - fault tripping indication by a red mechanical indicator in circuit breaker front face.



### Alternating current (AC) 50/60 Hz

Breaking capacity (Icu) according to IEC/EN 60947-2	Voltage (Ue)				Service breaking capacity (Ics)
	12 to 133 V	220 to 240 V	380 to 415 V	440 V	
Ph/Ph (2P, 3P, 4P)	12 to 133 V	220 to 240 V	380 to 415 V	440 V	100 % of Icu
Ph/N (1P, 2P)	12 to 60 V	100 to 133 V	220 to 240 V	-	
Rating (In)	0.5 to 4 A	50 kA	50 kA	50 kA	25 kA
	6 to 63 A	36 kA	20 kA	10 kA	6 kA

Breaking capacity (Icn) according to IEC/EN 60898-1	
	Voltage (Ue)
Ph/Ph	400 V
Ph/N	230 V
Rating (In)	0.5 to 63 A
	6000 A

### Direct current (DC)

Breaking capacity (Icu) according to IEC/EN 60947-2	Voltage (Ue)					Service breaking capacity (Ics)
	Between +/-	12 to 60 V	≤ 72 V	≤ 125 V	≤ 180 V	
Number of poles	1P			2P	3P	4P
Rating (In)	1 to 63 A	15 kA	10 kA	10 kA	10 kA	10 kA

## Catalogue numbers

iC60N circuit breaker						
Type	1P			1P+N		
Auxiliaries	Remote tripping and indication, module CA907000 and CA907002			Remote tripping and indication, module CA907000 and CA907002		
Vigi iC60	Vigi iC60 add-on residual current device, module CA902005			Vigi iC60 add-on residual current device, module CA902005		
Rating (In)	Curve			Curve		
	B	C	D	B	C	D
0.5 A	A9F73170	A9F74170	A9F75170	A9F73670	A9F74670	A9F75670
1 A	A9F73101	A9F74101	A9F75101	A9F73601	A9F74601	A9F75601
2 A	A9F73102	A9F74102	A9F75102	A9F73602	A9F74602	A9F75602
3 A	A9F73103	A9F74103	A9F75103	A9F73603	A9F74603	A9F75603
4 A	A9F73104	A9F74104	A9F75104	A9F73604	A9F74604	A9F75604
6 A	A9F73106	A9F74106	A9F75106	A9F73606	A9F74606	A9F75606
10 A	A9F73110	A9F74110	A9F75110	A9F73610	A9F74610	A9F75610
13 A	A9F73113	A9F74113	A9F75113	A9F73613	A9F74613	A9F75613
16 A	A9F73116	A9F74116	A9F75116	A9F73616	A9F74616	A9F75616
20 A	A9F73120	A9F74120	A9F75120	A9F73620	A9F74620	A9F75620
25 A	A9F73125	A9F74125	A9F75125	A9F73625	A9F74625	A9F75625
32 A	A9F73132	A9F74132	A9F75132	A9F73632	A9F74632	A9F75632
40 A	A9F73140	A9F74140	A9F75140	A9F73640	A9F74640	A9F75640
50 A	A9F73150	A9F74150	A9F75150	A9F73650	A9F74650	A9F75650
63 A	A9F73163	A9F74163	A9F75163	A9F73663	A9F74663	A9F75663
Width in 9-mm modules	2			4		
Accessories	Module CA907000 and CA907001			Module CA907000 and CA907001		

# iC60N circuit breakers (curve B, C, D) (cont.)

PB10434-40

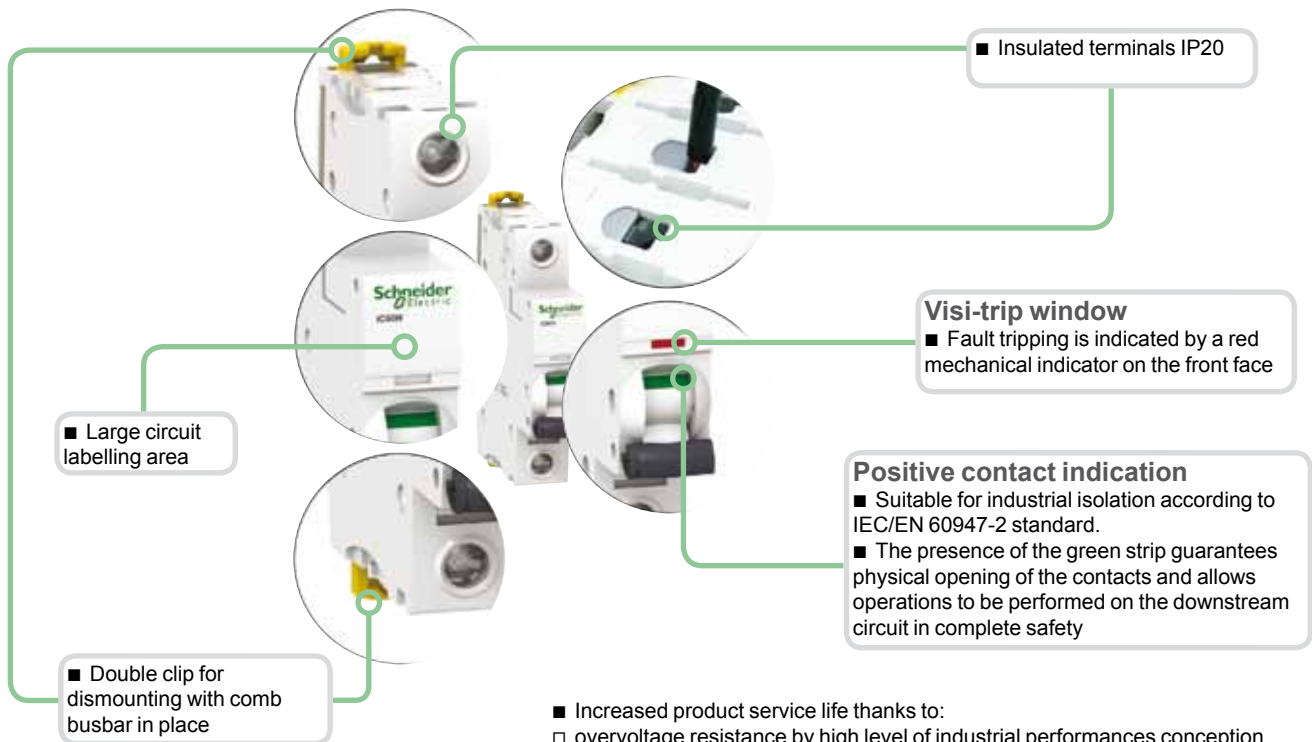

- Increased product service life thanks to:
  - overvoltage resistance by high level of industrial performances conception (pollution degree, rated impulse withstand voltage and insulation voltage),
  - high performance limitation (see limitation curves),
  - fast closing independent of the speed of actuation of the toggle.
- Remote indication, open/closed/tripped, by optional auxiliary contacts.
- Top or bottom electrical feeding.

2P				3P			4P										
E46094	1 3 ✱ ✱				E46095	1 3 5 ✱ ✱ ✱				E46097	1 3 5 7 ✱ ✱ ✱ ✱						
	2 4					2 4 6					2 4 6 8						
Remote tripping and indication, module CA907000 and CA907002				Remote tripping and indication, module CA907000 and CA907002			Remote tripping and indication, module CA907000 and CA907002										
Vigi iC60 add-on residual current device, module CA902005				Vigi iC60 add-on residual current device, module CA902005			Vigi iC60 add-on residual current device, module CA902005										
Curve				Curve			Curve										
B		C		D		B		C		D		B		C		D	
A9F73270	A9F74270	A9F75270	A9F73370	A9F74370	A9F75370	A9F73470	A9F74470	A9F75470									
A9F73201	A9F74201	A9F75201	A9F73301	A9F74301	A9F75301	A9F73401	A9F74401	A9F75401									
A9F73202	A9F74202	A9F75202	A9F73302	A9F74302	A9F75302	A9F73402	A9F74402	A9F75402									
A9F73203	A9F74203	A9F75203	A9F73303	A9F74303	A9F75303	A9F73403	A9F74403	A9F75403									
A9F73204	A9F74204	A9F75204	A9F73304	A9F74304	A9F75304	A9F73404	A9F74404	A9F75404									
A9F73206	A9F74206	A9F75206	A9F73306	A9F74306	A9F75306	A9F73406	A9F74406	A9F75406									
A9F73210	A9F74210	A9F75210	A9F73310	A9F74310	A9F75310	A9F73410	A9F74410	A9F75410									
A9F73213	A9F74213	A9F75213	A9F73313	A9F74313	A9F75313	A9F73413	A9F74413	A9F75413									
A9F73216	A9F74216	A9F75216	A9F73316	A9F74316	A9F75316	A9F73416	A9F74416	A9F75416									
A9F73220	A9F74220	A9F75220	A9F73320	A9F74320	A9F75320	A9F73420	A9F74420	A9F75420									
A9F73225	A9F74225	A9F75225	A9F73325	A9F74325	A9F75325	A9F73425	A9F74425	A9F75425									
A9F73232	A9F74232	A9F75232	A9F73332	A9F74332	A9F75332	A9F73432	A9F74432	A9F75432									
A9F73240	A9F74240	A9F75240	A9F73340	A9F74340	A9F75340	A9F73440	A9F74440	A9F75440									
A9F73250	A9F74250	A9F75250	A9F73350	A9F74350	A9F75350	A9F73450	A9F74450	A9F75450									
A9F73263	A9F74263	A9F75263	A9F73363	A9F74363	A9F75363	A9F73463	A9F74463	A9F75463									
4				6			8										
Module CA907000 and CA907001				Module CA907000 and CA907001			Module CA907000 and CA907001										

# iC60N circuit breakers (curve B, C, D) (cont.)

## Connection

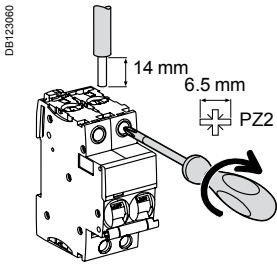

Rating	Tightening torque	Without accessory		With accessories			
		Copper cables		50 mm <sup>2</sup> Al terminal	Screw-on connection for ring terminal	Multi-cables terminal	
		Rigid	Flexible or ferrule			Rigid cables	Flexible cables
0.5 to 25 A	2 N.m	1 to 25 mm <sup>2</sup>	1 to 16 mm <sup>2</sup>	-	Ø 5 mm	-	-
32 to 63 A	3.5 N.m	1 to 35 mm <sup>2</sup>	1 to 25 mm <sup>2</sup>	50 mm <sup>2</sup>	-	3 x 16 mm <sup>2</sup>	3 x 10 mm <sup>2</sup>

## Technical data

Main characteristics		
According to IEC/EN 60947-2		
Insulation voltage (U <sub>i</sub> )		500 V AC
Pollution degree		3
Rated impulse withstand voltage (U <sub>imp</sub> )		6 kV
Thermal tripping	Reference temperature	50 °C
	Temperature derating	See module CA908007
Magnetic tripping	B curve	4 I <sub>n</sub> ± 20 %
	C curve	8 I <sub>n</sub> ± 20 %
	D curve	12 I <sub>n</sub> ± 20 %
Utilization category		A
According to IEC/EN 60898-1		
Limitation class		3
Rated making and breaking capacity of an individual pole (I <sub>cn1</sub> )		I <sub>cn1</sub> = I <sub>cn</sub>
Additional characteristics		
Breaking capacity under 1 pole with IT 380-415 V isolated neutral system (case of double fault)	40 A	4 kA
	50/63 A	3 kA
Degree of protection (IEC 60529)	Device only	IP20
	Device in modular enclosure	IP40 Insulation classe II
Endurance (O-C)	Electrical	10,000 cycles
	Mechanical	20,000 cycles
Overvoltage category (IEC 60364)		IV
Operating temperature		-35°C to +70°C
Storage temperature		-40°C to +85°C
Tropicalization (IEC 60068-1)		Treatment 2 (relative humidity 95 % to 55°C)

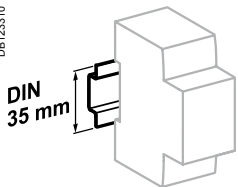

Clip on DIN rail 35 mm.

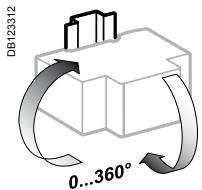

Indifferent position of installation.

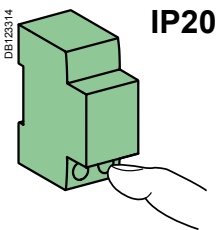

IP20

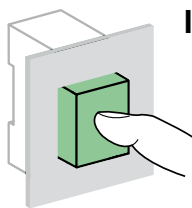

IP40

## Weight (g)

Circuit-breaker	
Type	iC60N
1P	125
2P	250
3P	375
4P	500

## Dimensions (mm)

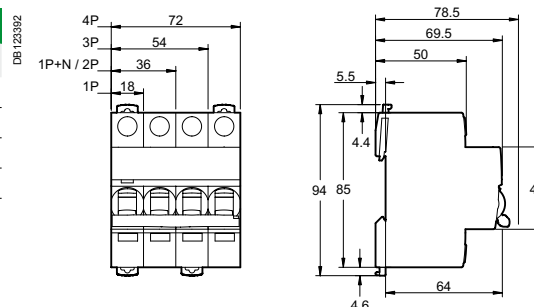

# iC60N double terminals circuit breakers (curve B, C, D)

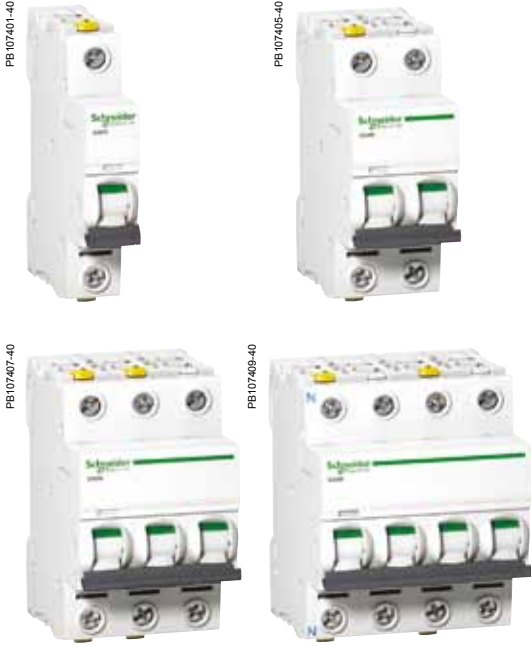
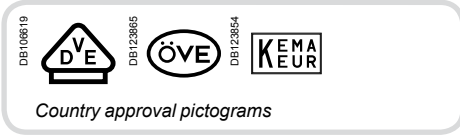

## IEC/EN 60947-2 IEC/EN 60898-1

- iC60N double terminals circuit breakers are multi-standard circuit breakers which combine the following functions:
  - circuit protection against short-circuit currents,
  - circuit protection against overload currents,
  - suitable for industrial isolation according to IEC/EN 60947-2, standard.
  - fault tripping indication by a red mechanical indicator in circuit breaker front face.

### Alternating current (AC) 50/60 Hz

Breaking capacity (Icu) according to IEC/EN 60947-2	Voltage (Ue)				Service breaking capacity (Ics)
	12 to 133 V	220 to 240 V	380 to 415 V	440 V	
Ph/Ph (2P, 3P, 3P+N, 4P)					100 % of Icu 75 % of Icu
Ph/N (1P, 1P+N)	12 to 60 V	100 to 133 V	220 to 240 V	-	
Rating (In)	0.5 to 4 A 6 to 63 A	50 kA 36 kA	50 kA 20 kA	50 kA 10 kA	25 kA 6 kA

### Breaking capacity (Icn) according to IEC/EN 60898-1

Breaking capacity (Icn) according to IEC/EN 60898-1	Voltage (Ue)	
	Ph/Ph	Ph/N
Rating (In)	0.5 to 63 A	6000 A

### Direct current (DC)

Breaking capacity (Icu) according to IEC/EN 60947-2	Voltage (Ue)					Service breaking capacity (Ics)
	Between +/-	12 to 60 V	≤ 72 V	≤ 125 V	≤ 180 V	
Number of poles	1P		2P	3P	4P	100 % of Icu
Rating (In)	1 to 63 A	15 kA	10 kA	10 kA	10 kA	

## Catalogue numbers

### iC60N double terminals circuit breaker

Type	1P	1P+N	2P
Auxiliaries	Remote tripping and indication, module CA907000 and CA907002	Remote tripping and indication, module CA907000 and CA907002	Remote tripping and indication, module CA907000 and CA907002
Vigi iC60	Vigi iC60 add-on residual current device, module CA902005	Vigi iC60 add-on residual current device, module CA902005	Vigi iC60 add-on residual current device, module CA902005
Rating (In)	Curve B C D	Curve B C	Curve B C D
0.5 A	- A9F04170 A9F05170	- A9F04670	- A9F04270 A9F05270
1 A	A9F03101 A9F04101 A9F05101	- A9F04601	- A9F04201 A9F05201
2 A	A9F03102 A9F04102 A9F05102	- A9F04602	A9F03202 A9F04202 A9F05202
3 A	- A9F04103 A9F05103	- A9F04603	- A9F04203 A9F05203
4 A	A9F03104 A9F04104 A9F05104	- A9F04604	A9F03204 A9F04204 A9F05204
6 A	A9F03106 A9F04106 A9F05106	A9F03606 A9F04606	A9F03206 A9F04206 A9F05206
10 A	A9F03110 A9F04110 A9F05110	A9F03610 A9F04610	A9F03210 A9F04210 A9F05210
13 A	A9F03113 A9F04113 A9F05113	A9F03613 A9F04613	A9F03213 A9F04213 A9F05213
16 A	A9F03116 A9F04116 A9F05116	A9F03616 A9F04616	A9F03216 A9F04216 A9F05216
20 A	A9F03120 A9F04120 A9F05120	A9F03620 A9F04620	A9F03220 A9F04220 A9F05220
25 A	A9F03125 A9F04125 A9F05125	A9F03625 A9F04625	A9F03225 A9F04225 A9F05225
32 A	A9F03132 A9F04132 A9F05132	A9F03632 A9F04632	A9F03232 A9F04232 A9F05232
40 A	A9F03140 A9F04140 A9F05140	A9F03640 A9F04640	A9F03240 A9F04240 A9F05240
50 A	A9F03150 A9F04150 A9F05150	A9F03650 A9F04650	A9F03250 A9F04250 A9F05250
63 A	A9F03163 A9F04163 A9F05163	A9F03663 A9F04663	A9F03263 A9F04263 A9F05263
Width in 9-mm modules	2	4	4
Accessories	Modules CA907000 and CA907001	Modules CA907000 and CA907001	Modules CA907000 and CA907001

# iC60N double terminals circuit breakers (curve B, C, D) (cont.)

- Insulated terminals IP20
- Large circuit labelling area
- Double clip locking allowing tool-free removal, front panel side, with the comb busbar in position
- Double terminals
  - For top or bottom connections:
    - by cable,
    - by comb busbar
- Visi-trip window
  - Fault tripping is indicated by a red mechanical indicator on the front face
- Positive contact indication
  - Suitable for industrial isolation according to IEC/EN 60947-2 standard
  - The presence of the green strip guarantees physical opening of the contacts and allows operations to be performed on the downstream circuit in complete safety
- Increased product service life thanks to:
  - overvoltage resistance by high level of industrial performances conception (pollution degree, rated impulse withstand voltage and insulation voltage),
  - high performance limitation (see limitation curves),
  - fast closing independent of the speed of actuation of the toggle.
- Remote indication, open/closed/tripped, by optional auxiliary contacts.
- Top or bottom electrical feeding.

3P			3P+N			4P		
Remote tripping and indication, module CA907000 and CA907002			Remote tripping and indication, module CA907000 and CA907002			Remote tripping and indication, module CA907000 and CA907002		
Vigi iC60 add-on residual current device, module CA902005			Vigi iC60 add-on residual current device, module CA902005			Vigi iC60 add-on residual current device, module CA902005		
Curve			Curve			Curve		
B	C	D	B	C		B	C	D
-	A9F04370	A9F05370	-	A9F04770	-	A9F04470	A9F05470	
-	A9F04301	A9F05301	-	A9F04701	-	A9F04401	A9F05401	
A9F03302	A9F04302	A9F05302	-	A9F04702	-	A9F04402	A9F05402	
-	A9F04303	A9F05303	-	A9F04703	-	A9F04403	A9F05403	
-	A9F04304	A9F05304	-	A9F04704	-	A9F04404	A9F05404	
A9F03306	A9F04306	A9F05306	A9F03706	A9F04706	A9F03406	A9F04406	A9F05406	
A9F03310	A9F04310	A9F05310	A9F03710	A9F04710	A9F03410	A9F04410	A9F05410	
A9F03313	A9F04313	A9F05313	A9F03713	A9F04713	A9F03413	A9F04413	A9F05413	
A9F03316	A9F04316	A9F05316	A9F03716	A9F04716	A9F03416	A9F04416	A9F05416	
A9F03320	A9F04320	A9F05320	A9F03720	A9F04720	A9F03420	A9F04420	A9F05420	
A9F03325	A9F04325	A9F05325	A9F03725	A9F04725	A9F03425	A9F04425	A9F05425	
A9F03332	A9F04332	A9F05332	A9F03732	A9F04732	A9F03432	A9F04432	A9F05432	
A9F03340	A9F04340	A9F05340	A9F03740	A9F04740	A9F03440	A9F04440	A9F05440	
A9F03350	A9F04350	A9F05350	A9F03750	A9F04750	A9F03450	A9F04450	A9F05450	
A9F03363	A9F04363	A9F05363	A9F03763	A9F04763	A9F03463	A9F04463	A9F05463	
6			8		8			
Modules CA907000 and CA907001			Modules CA907000 and CA907001			Modules CA907000 and CA907001		



# iC60N double terminals circuit breakers (curve B, C, D) (cont.)

## Connection between double terminal circuit breakers

With comb busbar at the back/cables at the front

Without comb busbar at the back/cables at the front

DBA04815



		Back	Front	
Rating	Tightening torque	Comb busbar	Copper cables	
		Thickness of the teeth	Rigid	Flexible or ferrule
0.5 to 25 A	2 N.m	1.5 mm	DB122945	DB122946
32 to 63 A	3.5 N.m	1.5 mm	1 to 25 mm <sup>2</sup>	1 to 16 mm <sup>2</sup>
			1 to 25 mm <sup>2</sup>	1 to 25 mm <sup>2</sup>

## Between double terminal circuit breakers and single-terminal circuit breakers

Cables at the back/comb busbar at the front

DBA04817



		Back	Front	
Rating	Tightening torque	Copper cables		Comb busbar
		Rigid	Flexible or ferrule	Thickness of the teeth
0.5 to 25 A	2 N.m	DB122945	DB122946	1.5 mm
32 to 63 A	3.5 N.m	1 to 16 mm <sup>2</sup>	1 to 10 mm <sup>2</sup>	1.5 mm
		1 to 16 mm <sup>2</sup>	1 to 10 mm <sup>2</sup>	1.5 mm

- Connection by comb busbar or by cable (according to EN 50027).

## Connection

DB123847

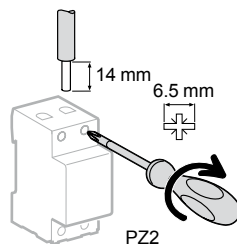

		With accessories		
Rating	50 mm <sup>2</sup> Al terminal	Screw-on connection for ring terminal	Multi-cables terminal	
		DB118789	Rigid cables	Flexible cables
0.5 to 25 A	-	DB122935	DB118787	-
32 to 63 A	50 mm <sup>2</sup>	Ø 5 mm	3 x 16 mm <sup>2</sup>	3 x 10 mm <sup>2</sup>

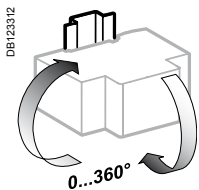

Indifferent position of installation.

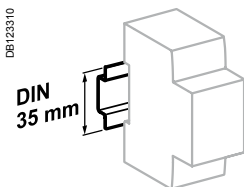
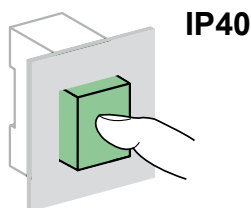
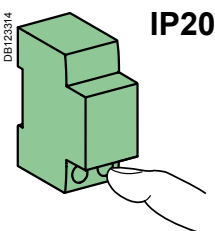

Clip on DIN rail 35 mm.

## Technical data

### Main characteristics

#### According to IEC/EN 60947-2

Insulation voltage (U <sub>i</sub> )	500 V AC
Pollution degree	3
Rated impulse withstand voltage (U <sub>imp</sub> )	6 kV
Thermal tripping	Reference temperature 50°C
	Temperature derating See module CA908007
Magnetic tripping	B curve 4 I <sub>n</sub> ± 20 %
	C curve 8 I <sub>n</sub> ± 20 %
	D curve 12 I <sub>n</sub> ± 20 %
Utilization category	A

#### According to IEC/EN 60898-1

Limitation class	3
Rated making and breaking capacity of an individual pole (I <sub>cn1</sub> )	I <sub>cn1</sub> = I <sub>cn</sub>

### Additional characteristics

Degree of protection (IEC 60529)	Device only IP20
	Device in modular enclosure IP40
	Insulation classe II
Endurance (O-C)	Electrical 10,000 cycles
	Mechanical 20,000 cycles
Overvoltage category (IEC 60364)	IV
Operating temperature	-35°C to +70°C
Storage temperature	-40°C to +85°C
Tropicalization (IEC 60068-1)	Treatment 2 (relative humidity 95 % to 55°C)

## Disassembly double terminals iC60 circuit breaker with the comb busbar in position

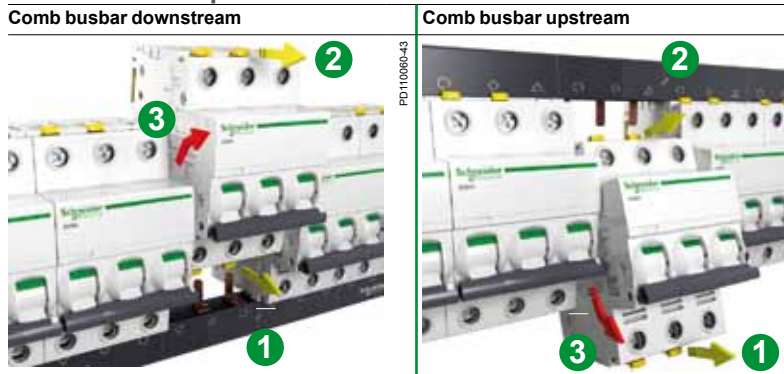

- 1- Pull lower "clip locking"
- 2- Pull upper "clip locking"
- 3- Remove the circuit breaker

## Dimensions (mm)

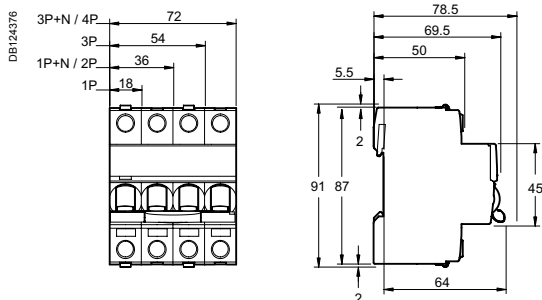

## Weight (g)

### Circuit-breaker

Type	iC60N
1P	125
2P (1P+N)	250
3P	375
4P (3P+N)	500

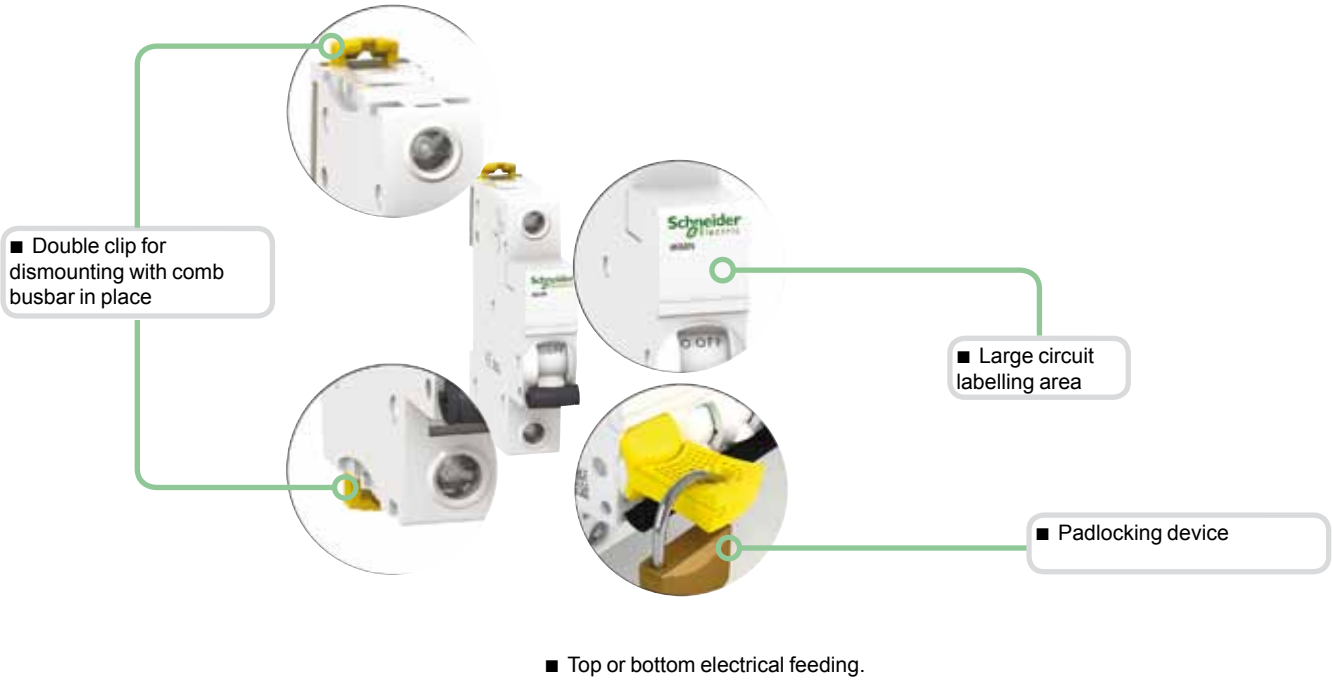

# iK60N circuit breakers (curve B) (cont.)

PB104434-40

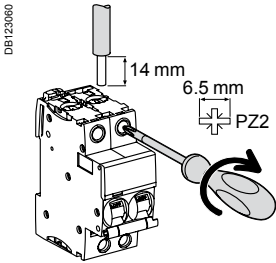

## Connection



Type	Rating	Tightening torque	Without accessory	
			Copper cables	
			Rigid	Flexible or ferrule
B curve	1 to 25 A	2 N.m		
	32 to 63 A	3.5 N.m		

# iK60N circuit breakers (curve B) (cont.)

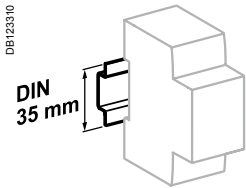

Clip on DIN rail 35 mm.

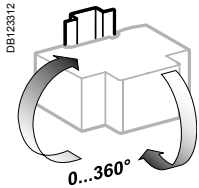

Indifferent position of installation.

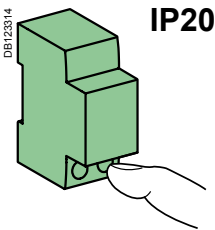

IP20

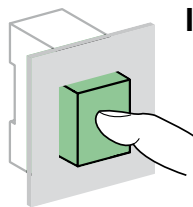

IP40

## Technical data

### Main characteristics

#### According to IEC/EN 60898-1

Insulation voltage (Ui)	440 V AC	
Pollution degree	2	
Rated impulse withstand voltage (Uimp)	4 kV	
Thermal tripping	Reference temperature	30°C
	Temperature derating	See module CA908007
Magnetic tripping	B curve	3 to 5 In
Limitation class	3	
Rated making and breaking capacity of an individual pole (Icn1)	Icn1 = Icn	
<b>Additional characteristics</b>		
Degree of protection (IEC 60529)	Device only	IP20
	Device in modular enclosure	IP40 Insulation classe II
Endurance (O-C)	Electrical	10,000 cycles
	Mechanical	20,000 cycles
Overvoltage category (IEC 60364)	III	
Operating temperature	-25°C to +60°C	
Storage temperature	-40°C to +85°C	

## Weight (g)

### Circuit-breaker

Type	iK60N
1P	100
2P	200
3P	300
4P	400

## Dimensions (mm)

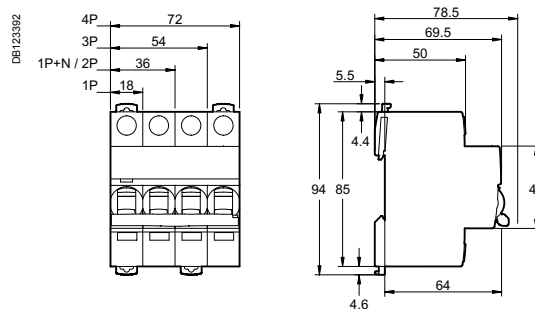



Schneider Electric's range of circuit breakers consists of different products (A, B, C) to enable it to be the most competitive range possible in each country, allowing for the special characteristics of each market:

- usual installation procedure
- price
- accreditations by local bodies.

### Variants

Offers		Pages
Offer A	Catalogue numbers	65
Offer B	Catalogue numbers	66
Offer C	Catalogue numbers	67
Common pages		68

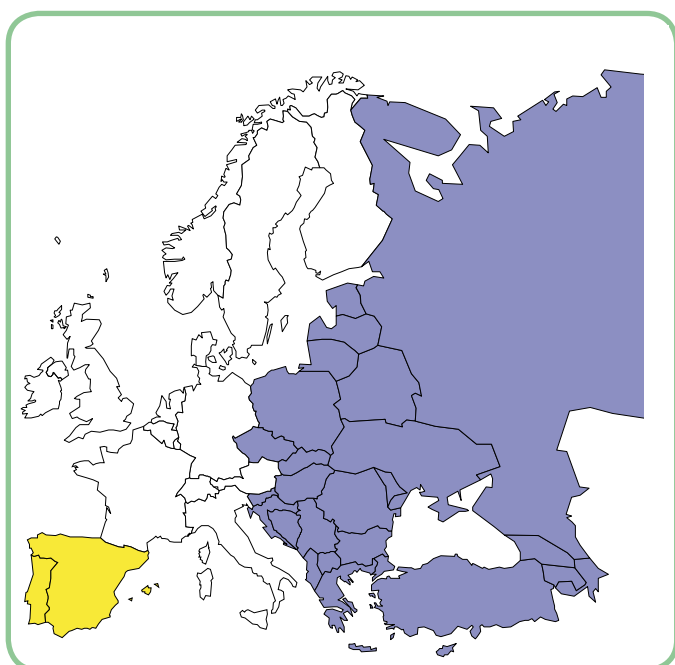

*Only the product range to be marketed in your country and validated by the local product manager, in agreement with his Final Distribution (FD) partner should be retained. The others will be removed before publication.*

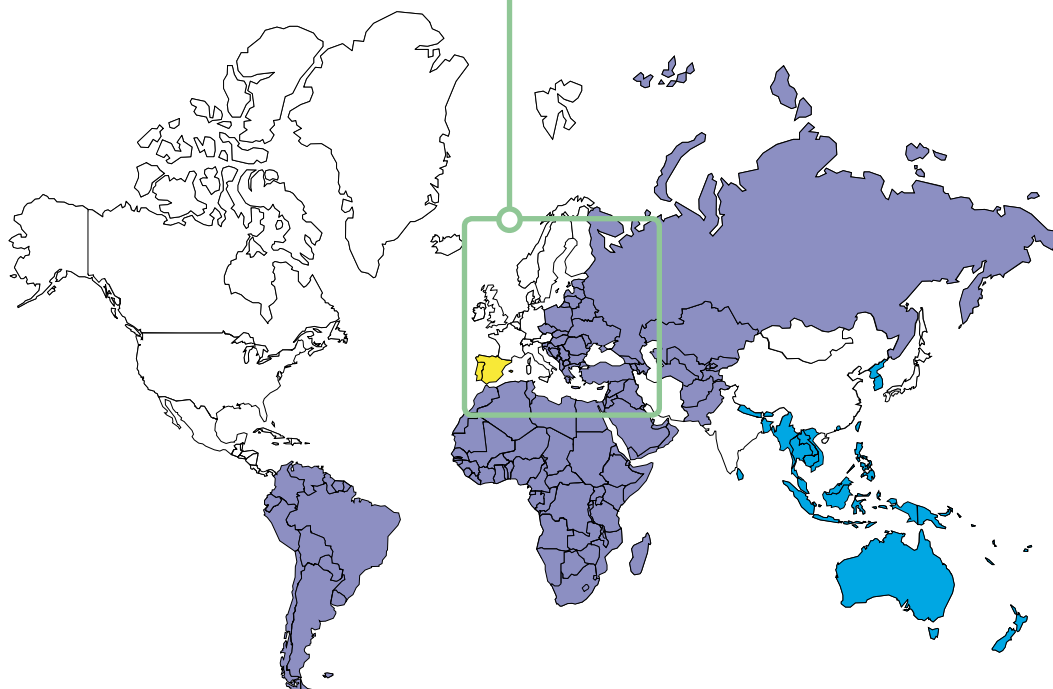



IEC/EN 60898-1



- iK60N circuit breakers are circuit breakers which combine the following functions:
  - circuit protection against short-circuit currents,
  - circuit protection against overload currents,
  - disconnection, opening and closing.

iK60N circuit breaker 50/60 Hz		Service breaking capacity (Ics)
Breaking capacity in short circuit (Icn) as per IEC/EN 60898-1		
Ph/Ph	400 V	100 % of Icn
Ph/N	230 V	
Rating (In) 1 to 63 A	6000 A	

## Catalogue numbers

iK60N circuit breakers						
Type	1P	1P+N	2P	3P	3P+N	4P
Auxiliaries	Without auxiliaries					
Vigi iC60	Without Vigi iC60					
Rating (In)	Curve C	Curve C	Curve C	Curve C	Curve C	Curve C
1 A <sup>(1)</sup>	A9K24101	A9K24601	A9K24201	-	-	-
2 A <sup>(1)</sup>	A9K24102	A9K24602	A9K24202	-	-	-
3 A <sup>(1)</sup>	A9K24103	A9K24603	A9K24203	-	-	-
4 A <sup>(1)</sup>	A9K24104	A9K24604	A9K24204	-	-	-
6 A	A9K17106	A9K17606	A9K17206	A9K17306	A9K24706	A9K17406
10 A	A9K17110	A9K17610	A9K17210	A9K17310	A9K24710	A9K17410
16 A	A9K17116	A9K17616	A9K17216	A9K17316	A9K24716	A9K17416
20 A	A9K17120	A9K17620	A9K17220	A9K17320	A9K24720	A9K17420
25 A	A9K17125	A9K17625	A9K17225	A9K17325	A9K24725	A9K17425
32 A	A9K17132	A9K17632	A9K17232	A9K17332	A9K24732	A9K17432
40 A <sup>(1)</sup>	A9K24140	A9K24640	A9K24240	A9K24340	A9K24740	A9K24440
50 A <sup>(1)</sup>	A9K24150	A9K24650	A9K24250	A9K24350	A9K24750	A9K24450
63 A <sup>(1)</sup>	A9K24163	A9K24663	A9K24263	A9K24363	A9K24763	A9K24463
Operating frequency	50/60 Hz	50/60 Hz	50/60 Hz	50/60 Hz	50/60 Hz	50/60 Hz
Width in 9-mm modules	2	4	4	6	8	8
Accessories	Module CA907000 and CA907001					

(1) VDE and RT approved, excepted 3P+N products.



IEC/EN 60898-1

PE104459-40



- iK60N circuit breakers are circuit breakers which combine the following functions:
  - circuit protection against short-circuit currents,
  - circuit protection against overload currents,
  - disconnection, opening and closing.

iK60N circuit breaker 50/60 Hz		Service breaking capacity (Ics)
Breaking capacity in short circuit (Icn) as per IEC/EN 60898-1		
Ph/Ph	400 V	100 % of Icn
Ph/N	230 V	
Rating (In) 1 to 63 A	6000 A	

## Catalogue numbers

iK60N circuit breakers					
Type	1P	1P+N	2P	3P	4P
Auxiliaries	Without auxiliaries				
Vigi iC60	Without Vigi iC60				
Rating (In)	Curve C	Curve C	Curve C	Curve C	Curve C
1 A	A9K24101	A9K24601	A9K24201	-	-
2 A	A9K24102	A9K24602	A9K24202	-	-
3 A	A9K24103	A9K24603	A9K24203	-	-
4 A	A9K24104	A9K24604	A9K24204	-	-
6 A	A9K24106	A9K24606	A9K24206	A9K24306	A9K24406
10 A	A9K24110	A9K24610	A9K24210	A9K24310	A9K24410
16 A	A9K24116	A9K24616	A9K24216	A9K24316	A9K24416
20 A	A9K24120	A9K24620	A9K24220	A9K24320	A9K24420
25 A	A9K24125	A9K24625	A9K24225	A9K24325	A9K24425
32 A	A9K24132	A9K24632	A9K24232	A9K24332	A9K24432
40 A	A9K24140	A9K24640	A9K24240	A9K24340	A9K24440
50 A	A9K24150	A9K24650	A9K24250	A9K24350	A9K24450
63 A	A9K24163	A9K24663	A9K24263	A9K24363	A9K24463
Operating frequency	50/60 Hz				
Width in 9-mm modules	2	4	4	6	8
Accessories	Module CA907000 and CA907001				

IEC/EN 60898-1

Country approval pictograms

PE104459-00



- iK60N circuit breakers are circuit breakers which combine the following functions:
  - circuit protection against short-circuit currents,
  - circuit protection against overload currents,
  - disconnection, opening and closing.

iK60N circuit breaker 50/60 Hz		Service breaking capacity (Ics) 100 % of Icn
Breaking capacity in short circuit (Icn) as per IEC/EN 60898-1		
Ph/Ph	400 V	
Ph/N	230 V	
Rating (In) 6 to 63 A	6000 A	

## Catalogue numbers

iK60N circuit breakers				
Type	1P	2P	3P	4P
Auxiliaries	Without auxiliaries			
Vigi IC60	Without Vigi IC60			
Rating (In)	Curve C	Curve C	Curve C	Curve C
1 A	A9K24101	-	-	-
2 A	A9K24102	-	-	-
3 A	A9K24103	-	-	-
4 A	A9K24104	-	-	-
6 A	A9K27106	A9K27206	A9K24306	A9K24406
10 A	A9K27110	A9K27210	A9K24310	A9K24410
16 A	A9K27116	A9K27216	A9K24316	A9K24416
20 A	A9K27120	A9K27220	A9K24320	A9K24420
25 A	A9K27125	A9K27225	A9K24325	A9K24425
32 A	A9K27132	A9K27232	A9K24332	A9K24432
40 A	A9K24140	A9K24240	A9K24340	A9K24440
Operating frequency	50/60 Hz	50/60 Hz	50/60 Hz	50/60 Hz
Width in 9-mm modules	2	4	6	8
Accessories	Module CA907000 and CA907001			



# iK60N circuit breakers (curve C) (cont.)

PB104434-40



## Connection

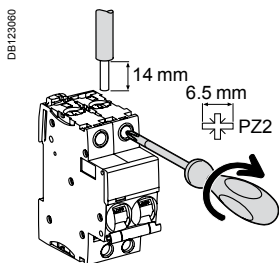

DB122860

## Without accessory

Type	Rating	Tightening torque	Copper cables	
			Rigid	Flexible or ferrule
C curve	1 to 32 A	2 N.m	DB122845	DB122846
	40 to 63 A	3.5 N.m	1 to 25 mm <sup>2</sup> 1 to 35 mm <sup>2</sup>	1 to 16 mm <sup>2</sup> 1 to 25 mm <sup>2</sup>

# iK60N circuit breakers (curve C) (cont.)

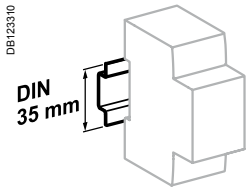

Clip on DIN rail 35 mm.

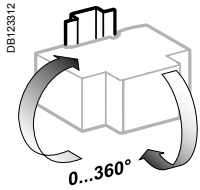

Position d'installation indifférente.

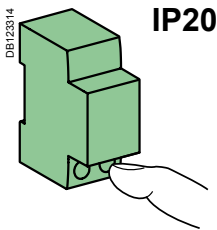

IP20

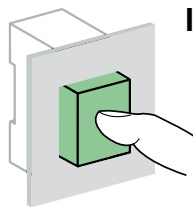

IP40

## Technical data

### Main characteristics

#### According to IEC/EN 60898-1

Insulation voltage (Ui)		440 V AC
Pollution degree		2
Rated impulse withstand voltage (Uimp)		4 kV
Thermal tripping	Reference temperature	30°C
	Temperature derating	See module CA908007
Magnetic tripping	C curve	5 to 10 In
Limitation class		3
Rated making and breaking capacity of an individual pole (Icn1)		Icn1 = Icn
<b>Additional characteristics</b>		
Degree of protection (IEC 60529)	Device only	IP20
	Device in modular enclosure	IP40 Classe d'isolement II
Endurance (O-C)	Electrical	10,000 cycles
	Mechanical	20,000 cycles
Overvoltage category (IEC 60364)		III
Operating temperature		-25°C to +60°C
Storage temperature		-40°C to +85°C

## Weight (g)

### Circuit-breaker

Type	iK60N
1P	100
2P (1P+N)	200
3P	300
4P (3P+N)	400

## Dimensions (mm)

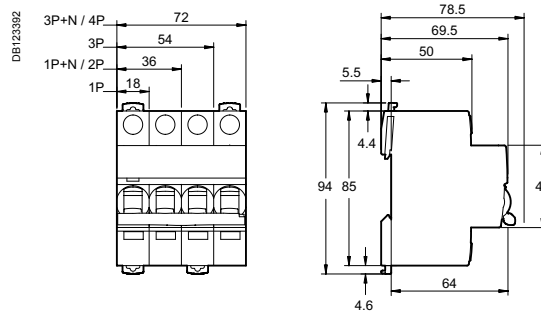



## IEC/EN 60898-1

- K60N Biconnect circuit breakers are circuit breakers which combine the following functions:
  - circuit protection against short-circuit currents,
  - circuit protection against overload currents,
  - disconnection, opening and closing.



### K60N Biconnect circuit breaker 50/60 Hz

Breaking capacity in short circuit (I <sub>cn</sub> ) as per IEC/EN 60898-1		Service breaking capacity (I <sub>cs</sub> )
Ph/Ph	400 V	
Ph/N	230 V	
Rating (I <sub>n</sub> )	2 to 40 A	

## Catalogue numbers

K60N Biconnect circuit breaker								
Type	1P		1P+N		3P		3P+N	
Auxiliaries	Without auxiliaries		Without auxiliaries		Without auxiliaries		Without auxiliaries	
Rating (In)	Curve		Curve		Curve		Curve	
	B	C	B	C	B	C	C	
2 A	-	A9K02102	-	-	-	-	-	-
4 A	-	A9K02104	-	-	-	-	-	-
6 A	A9K01106	A9K02106	-	-	A9K01306	A9K02306	-	-
10 A	A9K01110	A9K02110	-	-	A9K01310	A9K02310	-	-
13 A	A9K01113	A9K02113	A9K01613	A9K02613	-	A9K02313	A9K02713	-
16 A	A9K01116	A9K02116	A9K01616	A9K02616	A9K01316	A9K02316	A9K02716	-
20 A	A9K01120	A9K02120	-	-	A9K01320	A9K02320	-	-
25 A	A9K01125	A9K02125	-	-	A9K01325	A9K02325	-	-
32 A	A9K01132	A9K02132	-	-	A9K01332	A9K02332	-	-
40 A	A9K01140	A9K02140	-	-	A9K01340	A9K02340	-	-
Operating frequency	50/60 Hz	50/60 Hz	50/60 Hz	50/60 Hz	50/60 Hz	50/60 Hz	50/60 Hz	
Width in 9-mm modules	2	2	4	4	6	6	8	
Accessories	Padlocking device cat. no. 26970							

PB110016-60

■ Reinforced cable pull-out strength: serrated terminals

■ Fast closing independent of the speed of actuation of the toggle.



0572091\_SE-33



### Padlocking device

■ Padlocking possible for work to be carried out on live parts

### Connection

- Downstream by Biconnect comb busbar
- Upstream/downstream by tunnel terminals

DB405041



### Connection

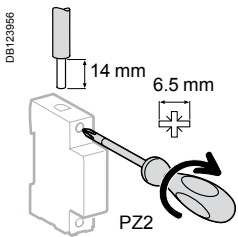

Type	Rating	Tightening torque	Copper cables	
			Rigid	Flexible or ferrule
K60N Biconnect	2 to 25 A	2 N.m	DB1223M45	DB1223M46
	32 - 40 A	3.5 N.m	0.5 to 35 mm <sup>2</sup>	0.5 to 25 mm <sup>2</sup>

■ Connection by comb busbar or cables (conforms to EN 50027).

# K60N circuit breakers Biconnect (cont.)

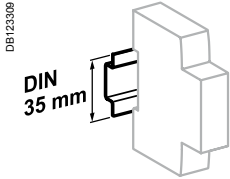

Clip on DIN rail 35 mm.

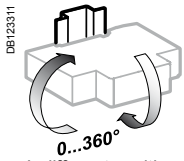

Indifferent position of installation.

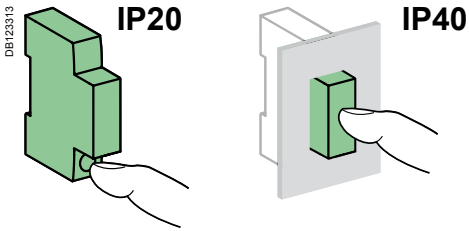

## Technical data

### Main characteristics

Insulation voltage (Ui)	Phase-to-phase	440 V AC	
Voltage rating (Ue)	Phase-to-neutral	230 V AC	
	Phase-to-phase	400 V AC	
Magnetic tripping	B curve	3 to 5 In	■
	C curve	5 to 10 In	■

### According to EN 60898-1

Limitation class	3
Rated breaking capacity (Icn)	6000 A
Service breaking capacity (Ics)	100 % Icn
Rated breaking and making capacity on a single pole (Icn1)	Icn1 = Icn

### Additional characteristics

Degree of protection (IEC 60529)	Device only	IP20
	Device in modular enclosure	IP40 Insulation classe II
Endurance (O-C)	Electrical	≤ 20 A 20,000 cycles
	≥ 25 A	10,000 cycles
	Mechanical	20,000 cycles
Operating temperature	-25 °C to +70 °C	
Storage temperature	-40 °C to +70 °C	
Tropicalization (IEC 60068-1)	Exécution 2 (humidité relative de 95 % à 55 °C)	

## Weight (g)

### Circuit-breaker

Type	K60N Biconnect
1P	120
1P+N	240
3P	360
3P+N	480

## Dimensions (mm)

