

Low voltage

Acti9

the efficiency you deserve

Catalogue
2011\12

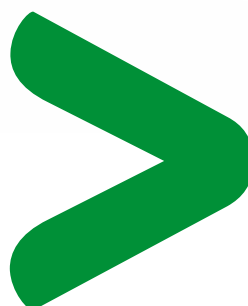



The efficiency you deserve

> Acti 9

The complete high performance
modular system for final distribution

Schneider
Electric

A close-up photograph of a person's hands using a red screwdriver to work on a network switch. The switch is white and has many ports, some of which are connected to blue and black cables. The person is wearing a red shirt. The background is blurred, showing more of the network equipment.

5 generations

of industry experience and 21 new patents
make Acti 9 the new reference in low voltage
modular systems.

> Acti 9

'In short, I optimize my own energy.'



The new core modular system that makes your power distribution installation safer, simpler, and more efficient

> High-quality modular system without compromise

We leveraged five generations of low voltage expertise to design a precise, high-quality modular system without compromise. The Acti 9 offers the fastest and most flexible installation experience, and completely eliminates safety concerns during maintenance and operation. Engineered to adapt to the most challenging networks and environments while remaining cost-effective over time, it is the most flexible, coordinated, comprehensive, and innovative range of low voltage modular systems available.

+ The Acti 9 gives you safety, simplicity, and efficiency for the life span of your installation.



★ Acti 9: The 5th generation of modular systems

Acti 9

The safest, simplest, and most efficient system for power distribution solutions

Protection Systems

- Miniature circuit breaker
- Integrated control circuit breaker
- Residual current circuit breaker
- Vigi module
- Surge arrester
- Automatic recloser auxiliary
- Remote control auxiliary
- Electrical auxiliaries



Safer

VisiSafe and Classes give complete safety for the life of your installation



More Efficient

VisiTrip, Super immunization, and automatic reclosers increase continuity of service and enhance reliability

Control Systems

Contactors
Impulse relays
Indicator lights
Push buttons
Selector switches

Installation Systems

IP OB terminals
Splitter block
Full range of mounting
and wiring accessories



Simpler and Smarter

Two certifications for one product, 100 MCB and RCD coordination, and easy ordering design

Fully BMS compatible, up to 50 less wiring, control mode flexibility adapts to changes, and 100 recyclable

Safe

Safest operation guaranteed even in the most demanding environments

100%

safe for installers and users in the most severe environments



The best choice for industrial and tertiary buildings



Designed for safety, even in the most demanding environments

Safety matters most, and the Acti 9 system gives you, your customers, and their installations the highest level of protection available. It guarantees 100 percent safe operation and maintenance for you and your customers; its international certifications and numerous protection innovations mean the Acti 9 system exceeds even the most demanding requirements to give you total safety during maintenance, for the lifetime of your installation.

Comprehensive certification



Delivers complete industry-approved protection

The Acti 9 is fully tested, approved, and certified by national and international third parties. It guarantees that your installation is safe and compliant with all relevant safety standards, and demonstrates to your customers that you use industry-approved materials and best practices.

'I have no worries about the safety of the electrical installation, the buildings, and everyone inside'.

Guarantees total safety during maintenance



VisiSafe

VisiSafe

VisiSafe guarantees the downstream circuit is always safe, regardless of overvoltage conditions, wear, or operator experience, even in the most demanding environments.

The green strip indicates the safe position of contacts.

Unique safety features:

- Highest Impulse voltage withstand: $U_{imp} = 6 \text{ kV}$
 - Guarantees longer equipment service life despite overvoltage conditions.
- Highest pollution resistance among modular devices: Pollution degree level 3
 - A true "all-terrain" product ideally suited for all environments.
- Leading edge insulation voltage: 500 V
 - Complete safety for operators maneuvering the operating handle.

Available only from Schneider Electric

Promises absolute protection against electric shocks



Available only from Schneider Electric

Class 2 Front Face

The Acti 9 is the only device available with this level of safety. Clearances between breaker surfaces and internal parts are over double the industry standard. It guarantees risk-free handling during the life of the installation, regardless of environment or operator experience.

Protects the load and guarantees long service life



Fast Closing Mechanism

Fast closure of all Acti 9 MCBs and RCCBs limits wear and reduces voltage drops, helping to prevent premature equipment aging and overheating.



Integrated Padlocking

Available for Acti 9 remote control devices, the rugged, integrated padlock allows complete lockdown for guaranteed protection and safety. It prevents toggle device movement and inadvertent or unauthorized access, so you can ensure employee or contractor safety at all times.

Ensures error-free linkages

Note: this QuickVigi section must be locally adapted in compliance with the local offer

QuickVigi

Fast, safe and screwless 'on-click' connections between MCB and add-on RCD modules. One click is all it takes. Complete operator safety is guaranteed.

Efficient

The system that streamlines your operations workflow



Designed to minimize downtime and avoid nuisance trips

With features like VisiTrip, which greatly reduces diagnostic and repair time, and super immunization of the RCDs to guarantee the highest continuity of service available, the Acti 9 system allows easier building management, eliminates downtime, and makes your business even more competitive, limiting intervention costs on distant infrastructure sites.

Less downtime, more continuity of service



VisiTrip

Available only from
Schneider Electric



VisiTrip minimizes downtime and reduces repair times
Identify faults in one glance, and easily see the operating status of your network. VisiTrip indicates only the faulty outgoing, allowing fast diagnosis, resolution, and re-closing loads for easier building management and reduced downtime.

'When I install the Acti 9 I know I don't have to come back to the job'.



100%

preventative maintenance

0

downtime

Prevents unnecessary trips

Available only from Schneider Electric

Super immunization (SI) of the RCDs guarantees the highest continuity of service and electrical immunity, especially where switchgear contends with electromagnetic or chemical interference. It also meets the high continuity of service requirements in all critical power applications (hospitals, data centres, telecoms, and tunnels).

Enhances service reliability



Acti 9 devices provide maximum continuity of service. Extended discrimination ranges allow for a variety of solutions for continuity of service, restricting downtime to only the affected circuit and leaving the rest of your installation intact.

No need for on-site intervention



The Acti 9 introduces a new automatic recloser auxiliary (ARA iC60) designed to limit the cost of intervention on far away infrastructure sites. No need to have permanent on-site teams responding to transient faults, limiting distant site intervention costs.

Simple and Smart |



The right solution for every application

The Acti 9 simplifies final distribution operations in buildings and industrial facilities, giving you the right solution with the right technical characteristics, for every application. As new installation standards emerge or building requirements are modified, the Acti 9 system can easily scale to meet your needs. It's a flexible, open system with all-in-one, integrated components that can communicate with any building management system.

Designed to be simple to choose, easy to design, and straightforward to install

Easy to design and choose



The Acti 9 complies with IEC EN 947 (industrial) and IEC EN 898 (tertiary) standards @two certifications in one product @making it perfect for commercial and industrial applications.

Supports intuitive ordering and design

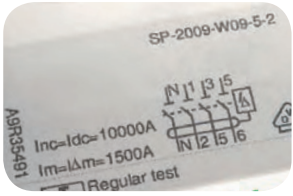

Meaningful part numbers mean no mistakes and no doubts when ordering or designing. Get the product type, poles and rating in one glance.

A9XXX 225 2P, 25A

Conforms to any BMS



Re ex iC60 has integrated signal auxiliaries for complete simplicity. Its control mode flexibility easily adapts to changes in your installation, optimizing design time for lighting and building control.

Offers a new, economic MCB and RCCB range



The Acti 9 is optimized for simple applications. Its economic MCB and RCCB ranges are perfect for basic applications in tertiary and industrial operations.

- MCB: i 60N complies with IEC898 (single breaking capacity Icn=6000A)
- RCCB: iD 60 complies with IEC61008 (30mA and 300mA AC sensitivity)

These ranges do not include VisiSafe, VisiTrip, auxiliaries or accessories (except padlocking feature).

Note: this iC 60 section must be locally adapted in compliance with the local offer

Reflex iC60: the all-in-one concept integrated control circuit breaker of the Acti 9 system



The Re ex iC60 combines an MCB with an internal actuator. Designed to evolve and adapt with the dynamic requirements of tertiary and industrial lighting control applications, it easily communicates with PLCs and BMS systems without the need for add-ons, retrofits, or extras. Everything you need is included.

Available only from Schneider Electric



Guarantees 100 coordination



100 percent coordination between RCDs and MCBs means no more searching through technical guides or coordination tables. Plus, in the Re ex iC60 the MCB and internal actuator are a unique all-in-one concept fully covered by the manufacturer warranty.

30%

of switchboards are modified at design, cabling, or commissioning stages, increasing project start-up times.

Simple and Smart



Easy to install

Up to 50% less wiring



Reflex iC60 all-in-one concept means up to 50% less wiring for reduced cabling and more efficient verification and connection.

Lighting control solution without (left) with (right) Reflex iC60 "all in one concept"

Allows heavy-duty, reliable tightening



Twice the terminal tightening torque for more robust connections.

Safe and secure connections



Provides secure connections with quick, ergonomic and safe IP20B terminals shutters.

'Everything is simpler with Acti 9. Whatever the application, I have no second thoughts'.

Easy to operate

Provides greater readability

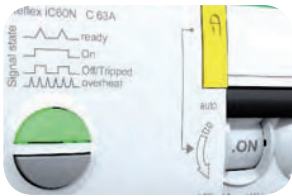

Ergonomic interface with specific colour coding for locking padlocking devices. N indicator for easy readability and speed of servicing.

Allows quick intervention



Large area for circuit identification allows quick intervention and leaves no doubt about referenced circuits. Acti 9 label maker gives your installation a professional appearance.

Comes with tailored accessories



The Acti 9 system includes a comprehensive list of accessories: easily-installed padlock system, splitter block, rotary handle mount for switchboard doors, screw shields, sealable terminal shields, plug-in base, interpole barrier, and clip-on markers.

Easy to upgrade

Adapts to your installation



Double DIN rail locker allows circuit changeouts without removing the comb. It adapts to new requirements and simplifies switchboard evolution.

Evolves with changing site requirements



Multiclip distribution system allows you to quickly add outgoing and balance phases. Multiclip offers screwless, safe connections.

100%

coordination between MCB and actuator

15%

time saved on design and installation

Attractive and environmentally friendly



Advanced ergonomics and attention to all detail

The Acti 9 is designed to be noticed. We incorporated clean lines with distinctive, gently rounded shapes to give the Acti 9 its faultless appearance. It immediately suggests well-designed and user-friendly aesthetics and particular attention to detail. Clarity of identified circuits and elegant appearance will have your customers impressed with their outstanding installations.



Acti 9 lets you touch and feel the difference.

High quality, subtle, and precise

Holding the Acti 9 in your hand, you can feel the high quality. Contacts close quickly and precisely, with no hint of dubious noise. The solid fit of its components and its smooth surfaces mean you can feel the difference even before you use it.

“You can tell it’s a high Quality product when you hold it in your hands’.



A better use of energy, from start to finish

The Acti 9 helps you meet developing energy efficiency and environmental certifications or requirements, now and in the future. It minimizes impact from the design stage, through the installation's lifetime of use, and eventual recycling. Through both design and technology, the Acti 9 provides you with the key combination of less impact and more efficiency that is necessary for the environment today.

100%

recyclable and recoverable materials, RoHS compliant, and REACH

The Acti 9 is your safe, efficient, and simple choice for low voltage modular systems.

20%

savings in energy losses

Acti 9

Safe, efficient, simple, and smart

Circuit breakers

- 1 pole
- 2 poles
- 3 poles
- 4 poles

Electrical auxiliaries

Tripping, notification, indication, and remote status indication

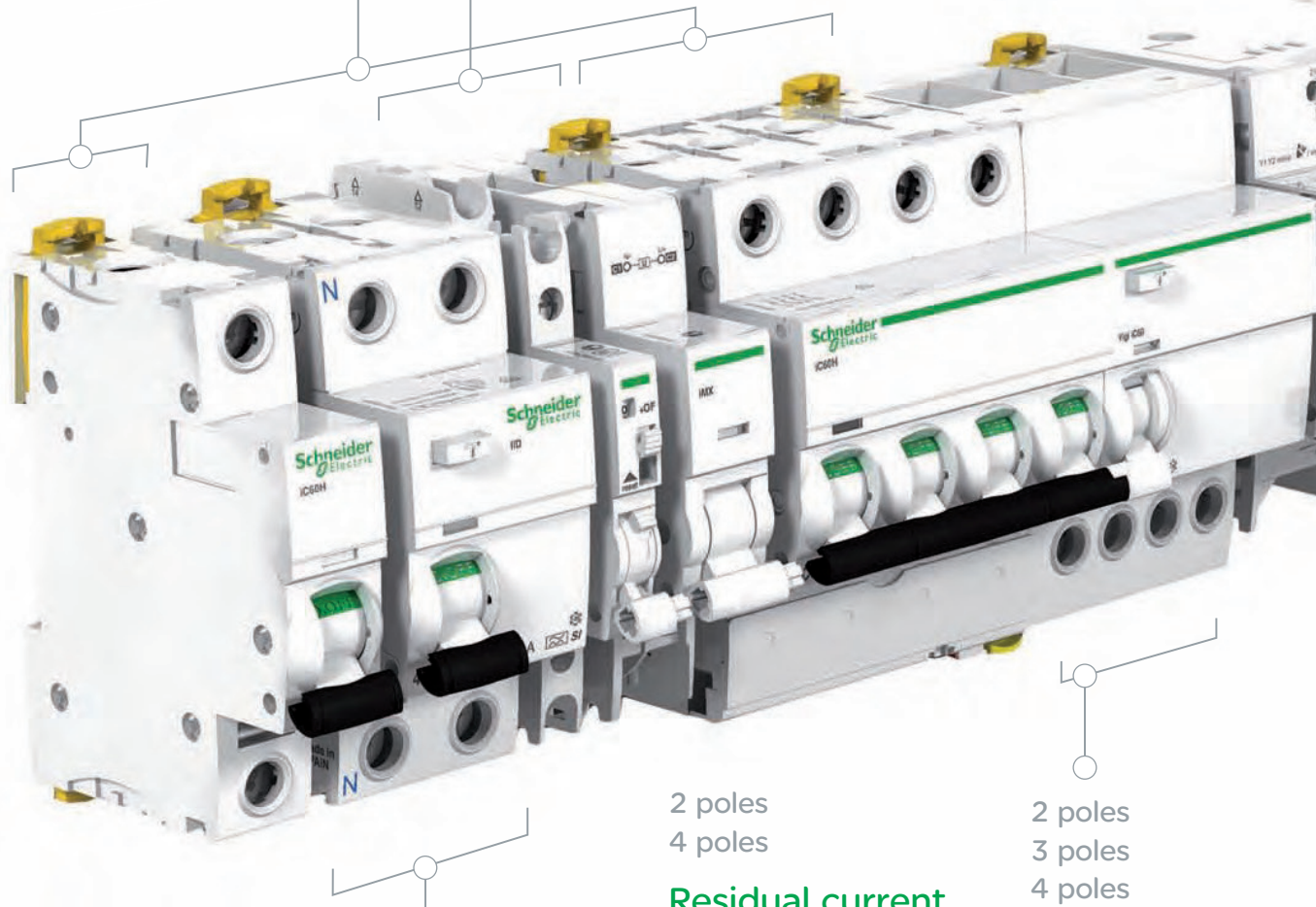

- 2 poles
- 4 poles

Residual current circuit breaker

- 2 poles
- 3 poles
- 4 poles

Vigi module

100%

safe for installers and users in the most severe environments

100%

coordination between MCB and actuator

100%

preventative maintenance

'I always have the right solution, at the right price with the right technical characteristics for each application'.

Control

Contactors, impulse relays, indicator lights, push buttons, and selector switches, etc.

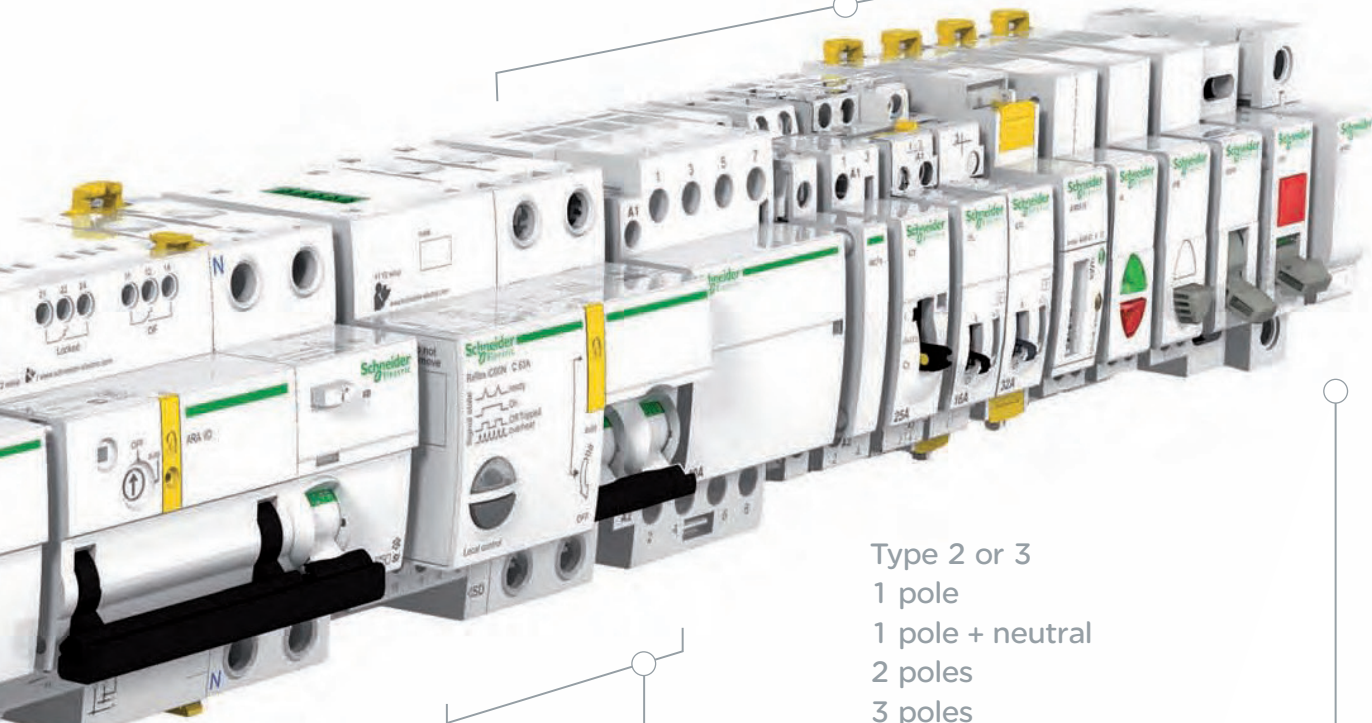

Type 2 or 3
1 pole
1 pole + neutral
2 poles
3 poles
3 poles + neutral
4 poles

Surge Arresters

2 poles
3 poles
4 poles

Integrated remote control circuit breaker

Automatic recloser auxiliaries

15%

time saved on design and installation

0%

downtime



The best choice for industrial and tertiary buildings

Technical characteristics

Circuit breakers

iC60a N, H, L, LMA

ICU (A) at 400V - IEC/EN 60898-1	6000, 10000, 15000
ICU (kA) at 415V - IEC/EN 60947-2	6,10, 15, 20, 25, 50, 70, 100
Type	1P, 2P, 3P, 4P
Rating (A)	0,5 to 63
Curves	B, C, D
Standards	IEC/EN 60947-2, 60898-1
Degree of protection	IP20/IP40



Add-on residual current devices

vigi iC60

RCD Type	Asi AC
Type	2P, 3P, 4P
Rating (A)	25, 40, 63
Standards	IEC/EN 61009-1
Sensitivity (mA)	10, 30, 100, 300, 300 <input type="checkbox"/> S, 500, 500 <input type="checkbox"/> S, 1000 <input type="checkbox"/> S
Degree of protection	IP20/IP40
Connection between iC60 & iC60 vigi	'Quick connection' up to 40A



Residual current circuit-breakers

iID

iIDK

RCD Type	Asi, 2AC	AC
Type	2P, 4P	2P, 4P
Rating (A)	16 to 125	25, 40, 63
Standards	IEC/EN 61008-1	IEC/EN 61008-1
Sensitivity (mA)	10, 30, 100, 300, 300 <input type="checkbox"/> S, 500, 500 <input type="checkbox"/> S	30, 300
Degree of protection	IP20/IP40	IP40



Installation and wiring

Multiclip splitter block

Distribloc splitter block

Rating (A)	80	63
Degree of protection	IP20	IP20



Surge arresters type 2 or 3

iPF, iPRD

Type	1P, 1P+N, 2P, 3P, 3P+N, 4P
I max (kA)	8, 20, 40, 65
Standards	IEC 61643-1, IEC 61643-11
Degree of protection	IP20/IP40



Integrated remote control MCBs

Reflex iC60N, iC60H

Curves	B, C, D
Type	2P, 3P, 4P
Rating (A)	10, 16, 25, 40
Standards	IEC 60947-2
Electrical endurance	30000 cycles (AC1) 6000 cycles (AC5 a/b) 50000 cycles (AC21)
Degree of protection	IP20/IP40



Control

iCT

iTL

iPB

iSSW

iIL

iEN, iME

Function	Contactors	Impulse Relays	Pushbuttons	Switches	Indicator Lights	kilowatt hour meters
Type	1P, 2P, 3P, 4P	1P, 2P	single, double, single + indicator light	1P, 2P, 3P, 4P	single, double, flashing light, voltage presence	single phase, three phases, three phases and neutral
Rating (A)	16, 25, 40	16 & 32	20	20 to 125		40 to 6000
Standards	IEC/EN 61095	EN 60669-1, EN 60669-2-2	IEC 60669-1, IEC 60947-5-1	IEC 60669-1, IEC 60669-2-4, IEC 60947-3, IEC 60947-5-1	IEC 60947-5-1	IEC 62053-21, IEC 61557-12
Electrical endurance (O-C operations)	100 per day	100.000 AC22(16A) 200.000 AC22(32A)	30,000 AC22	30,000 AC22		



Electrical auxiliaries and mounting accessories

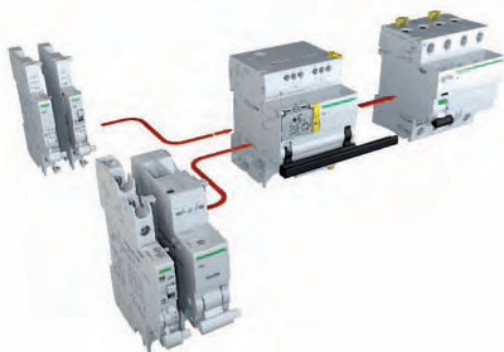

Combined iOF, iSD, iMN, iMX, and iMSU electrical auxiliaries between iC60 circuit breakers and iD residual current circuit breakers, automatic recloser and remote control auxiliaries.



Terminal shields, interpole barrier, screw shields, plug-in base, padlocking device, clip-on terminal markers, and rotary handle.

Make the most of your energy

Head Office

1 River View Office Park

Janadel Avenue

Halfway Gardens, Midrand,

Rivate Bag X139

Halfway House 1685

Tel: 011 254 6400

Fax: 011 254 6700

www.schneider-electric.com

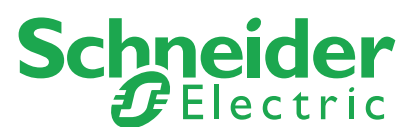

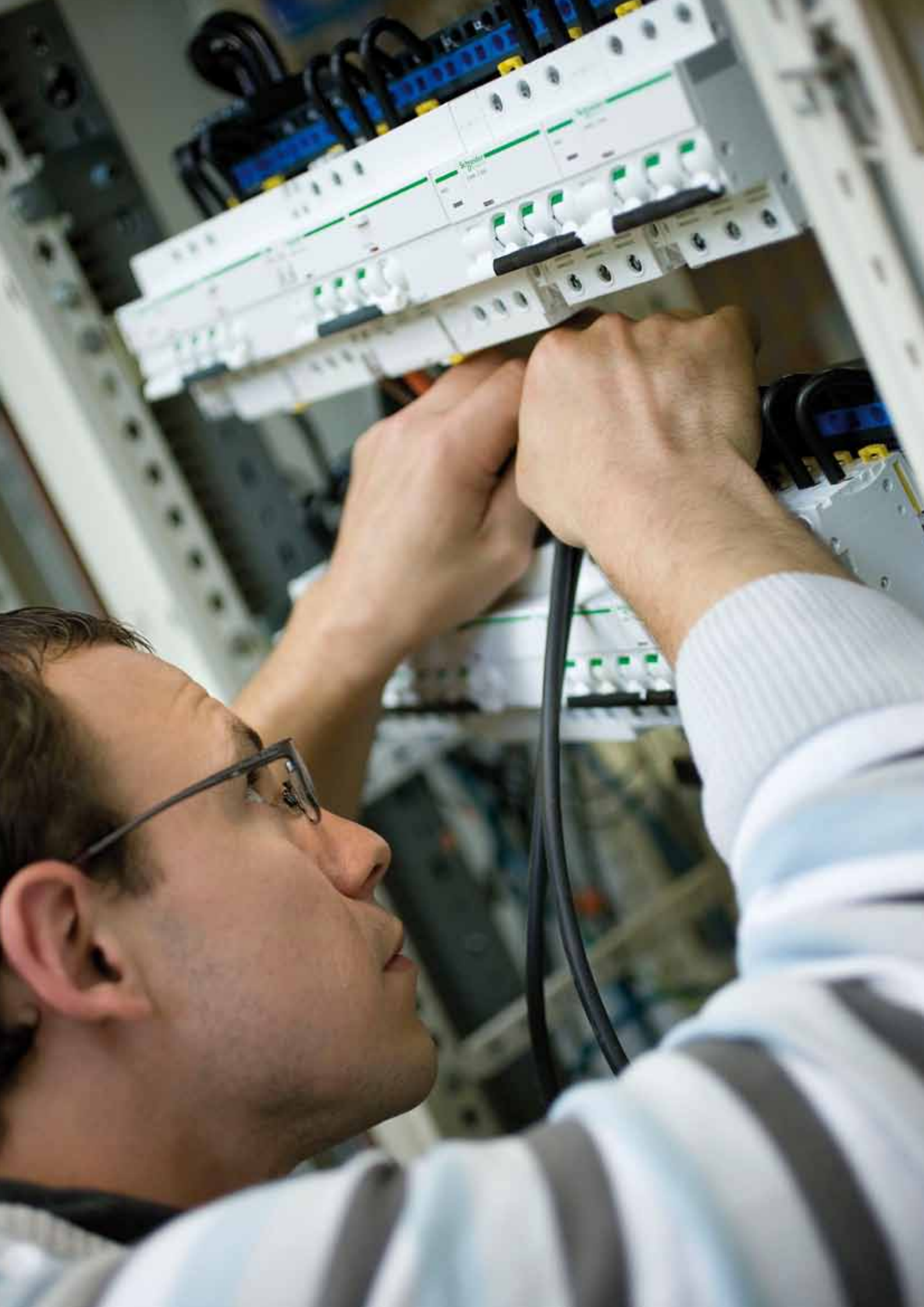

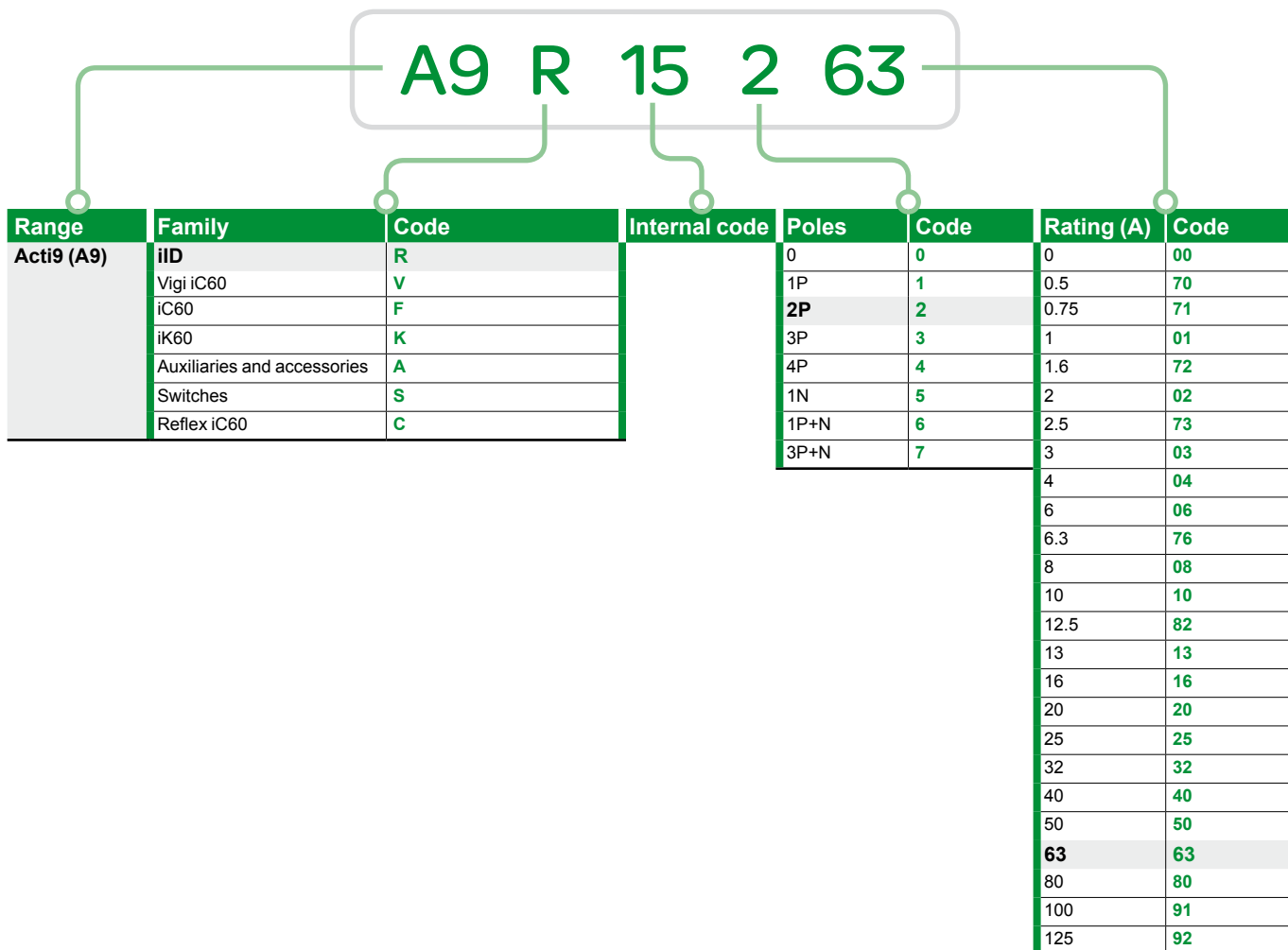

Description

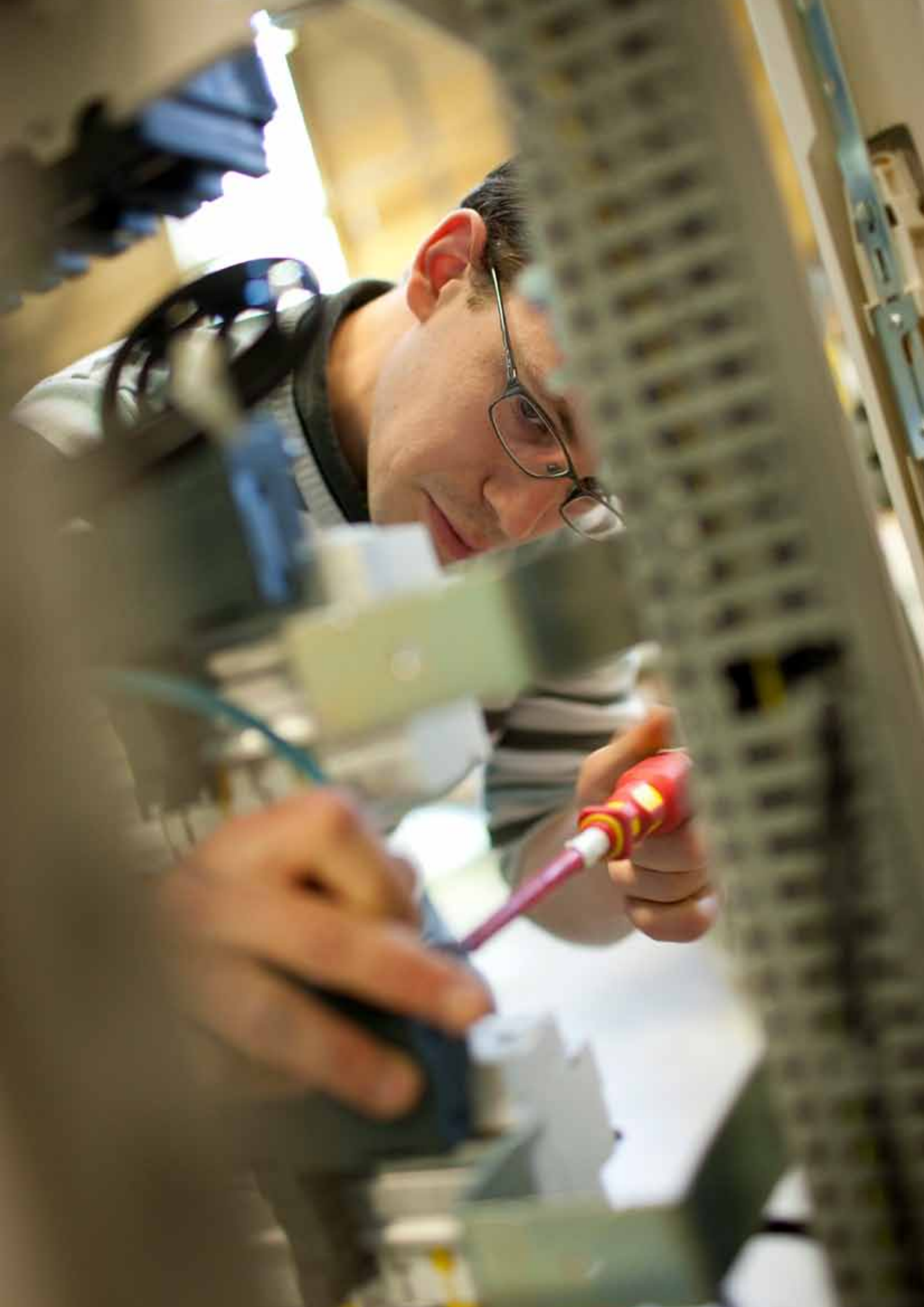



Selection guide



Circuit breakers

Type	iC60A		iC60N			
						
Standard	IEC/EN 60898-1, 60947-2		IEC/EN 60947-2, 60898-1			
Quality label	Country approval pictogram		Country approval pictogram			
Number of poles	1P	2, 3, 4P –	1P, 1P+N	2, 3, 4P		
Add-on residual current devices (Vigi)	■		■			
Auxiliaries for remote tripping and indication	■		■			
Electrical characteristics						
Curves	C		B, C, D			
Ratings (A)	In	1 to 63	0.5 to 63			
Maximum operational voltage (V)	Ue	AC (50/60 Hz)	440			
	max	DC	250			
Minimum operational voltage (V)	Ue	AC (50/60 Hz)	12			
	min	DC	12			
Insulation voltage (V AC)	Ui	500	500			
Rated impulse withstand voltage (kV)	Uimp	6	6			
Breaking capacity						
AC-Breaking capacity	Ue (50/60 Hz)	Ph / N	Ph / Ph	Ph / N	Ph / Ph	
IEC 60947-2 (kA)	lcu	12...60 V	–	–	50 (0.5 to 4 A) 36 (6 to 63 A)	–
		12...133 V	–	–	–	50 (0.5 to 4 A) 36 (6 to 63 A)
		100...133 V	–	–	50 (0.5 to 4 A) 20 (6 to 63 A)	–
		220...240 V	6	10	50 (0.5 to 4 A) 10 (6 to 63 A)	50 (0.5 to 4 A) 20 (6 to 63 A)
		380...415 V	–	6	–	50 (0.5 to 4 A) 10 (6 to 63 A)
		440 V	–	–	–	25 (0.5 to 4 A) 6 (6 to 63 A)
	ics		100 % of lcu		100 % of lcu (0.5 to 4 A) 75 % of lcu (6 to 63 A)	
EN 60898 (A)	lcn	230/400 V	4500	4500	6000	6000
DC-Breaking capacity						
IEC 60947-2 (kA)	lcu	12...60 V (1P)	–	–	15	–
		100...133 V (2P)	–	–	–	20
		100...133 V (3P)	–	–	–	30
		220...250 V (4P)	–	–	–	40
	ics		100 % of lcu		100 % of lcu	
Other characteristics						
Suitable for industrial isolation according to IEC/EN 60947-2	■		■			
Fault tripping indication	Visi-trip window		Visi-trip window			
Positive contact indication	■		■			
Fast closing	■		■			
Dismounting with comb busbar in place	Upstream connection		Upstream connection			
Degree of protection	IP	Device only	IP20	IP20	IP20	
		Device in modular enclosure	IP40	IP40	IP40	
		Insulation class II	Insulation class II	Insulation class II		
For more detail, see module		Page 32	Page 36			
Accessories		Pages 123 and 136	Pages 123 and 136			
Auxiliaries		Pages 123 and 136	Pages 155 and 168			
Add-on residual current devices (Vigi)		Page 82	Page 82			

(1) 100 % of lcu for ratings 6 to 25 A under Ue 100 to 133 V AC Ph/Ph and Ue 12 to 60 V AC Ph/N.

iC60H		iC60L		iC60LMA	
					
IEC/EN 60947-2, 60898-1		IEC/EN 60947-2, 60898-1		IEC/EN 60947-2	
Country approval pictogram		Country approval pictogram		Country approval pictogram	
1P	2, 3, 4P	1P	2, 3, 4P	2, 3	
■		■		■	
■		■		■	
B, C, D		B, C, K		MA	
0.5 to 63		0.5 to 63		1.6 to 40	
440		440		440	
250		250		250	
12		12		12	
12		12		12	
500		500		500	
6		6		6	
Ph / N	Ph / Ph	Ph / N	Ph / Ph	Ue (50/60 Hz)	
70 (0.5 to 4 A) 42 (6 to 63 A)	–	100 (0.5 to 4 A) 70 (6 to 63 A)	100 (0.5 to 4 A) 80 (6 to 63 A)	–	
–	70 (0.5 to 4 A) 42 (6 to 63 A)	–	–	–	
70 (0.5 to 4 A) 30 (6 to 63 A)	–	100 (0.5 to 4 A) 50 (6 to 25 A) 36 (32/40 A) 30 (50/63 A)	100 (0.5 to 4 A) 70 (6 to 63 A)	–	
70 (0.5 to 4 A) 15 (6 to 63 A)	70 (0.5 to 4 A) 30 (6 to 63 A)	100 (0.5 to 4 A) 25 (6 to 25 A) 20 (32/40 A) 15 (50/63 A)	100 (0.5 to 4 A) 50 (6 to 25 A) 36 (32/40 A) 30 (50/63 A)	100 (1.6 to 4 A) 50 (6.3 to 25 A) 36 (40 A)	
–	70 (0.5 to 4 A) 15 (6 to 63 A)	–	100 (0.5 to 4 A) 25 (6 to 25 A) 20 (32/40 A) 15 (50/63 A)	100 (1.6 to 4 A) 25 (6.3 to 25 A) 20 (40 A)	
–	50 (0.5 to 4 A) 10 (6 to 63 A)	–	70 (0.5 to 4 A) 20 (6 to 25 A) 15 (32/40 A) 10 (50/63 A)	50 (1.6 to 4 A) 20 (6.3 to 25 A) 15 (40 A)	
100 % of Icu (0.5 to 4 A) 50 % of Icu (6 to 63 A)		100 % of Icu (0.5 to 4 A) 50 % of Icu (6 to 63 A) ⁽¹⁾		50 % of Icu (1.6 to 40 A)	
10000	10000	15000	15000	–	
20	–	25	–	–	
–	25	–	30	–	
–	40	–	50	–	
–	50	–	70	–	
100 % of Icu		100 % of Icu		–	
■		■		■	
Visi-trip window		Visi-trip window		Visi-trip window	
■		■		■	
Upstream connection		Upstream connection		Upstream connection	
IP20		IP20		IP20	
IP40		IP40		IP40	
Insulation class II		Insulation class II		Insulation class II	
Page 40		Page 44		Page 48	
Pages 123 and 136		Pages 123 and 136		Pages 155 and 168	
Pages 155 and 168		Pages 155 and 168		Pages 155 and 168	
Page 82		Page 82		Page 82	

Selection guide (cont.)

Circuit breakers						
Type		C120N			C120H	
						
Standard		IEC 60947-2, IEC/EN 60898-1			IEC 60947-2, IEC/EN 60898-1	
Quality label		Country approval pictogram			Country approval pictogram	
Number of poles		1P	2, 3, 4P		1P	2, 3, 4P
Add-on residual current devices (Vigi)		■			■	
Auxiliaries for remote tripping and indication		■			■	
Electrical characteristics						
Curves		B, C, D			B, C, D	
Ratings (A)		In	63, 80, 100, 125		10 to 125	
Maximum operational voltage (V)		Ue	AC (50/60 Hz)	240/440		240/440
		max	DC	125 per pole		125 per pole
Minimum operational voltage (V)		Ue	AC (50/60 Hz)	12		12
		min	DC	12		12
Insulation voltage (V AC)		Ui	500			500
Rated impulse withstand voltage (kV)		Uimp	6			6
Breaking capacity						
AC-Breaking capacity		Ue	(50/60 Hz)	Ph / N	Ph / Ph	Ph / Ph
IEC 60947-2 (kA)		Icu	110...130 V	–	–	–
			130 V	20	–	30
			220...240 V	–	–	–
			230/400 V	10	20	15
			380...415 V	–	–	–
			400/415 V	3 ⁽¹⁾	10	4.5 ⁽¹⁾
			440 V	–	6	10
			500 V	–	–	–
		Ics	75 % of Icu			50 % of Icu
EN 60898 (A)		Icn	230/400 V	10000	10000	15000
DC-Breaking capacity		Ue	DC	Ph / N	Ph / Ph	Ph / Ph
IEC 60947-2 (kA)		Icu	60 V (1P)	10	–	15
			125 V (1P)	10	–	15
			250 V (2P)	–	10	15
			500 V (4P)	–	–	–
		Ics	100 % of Icu			100 % of Icu
Other characteristics						
Suitable for industrial isolation according to IEC/EN 60947-2		■			■	
Fault tripping indication		–			–	
Positive contact indication		■			■	
Fast closing		■			■	
Dismounting with comb busbar in place		Special comb busbar			Special comb busbar	
Degree of protection		IP	Device only	IP20		IP20
			Device in modular enclosure	IP40		IP40
For more detail, see module		Page 60			Page 64	
Accessories		Page 123			Page 123	
Auxiliaries		Page 123			Page 123	
Earth leakage module (Vigi)		Page 89			Page 89	

(1) Breaking capacity under 1 pole with IT isolated neutral system (case of double fault).

iC60a circuit breakers (curve C)

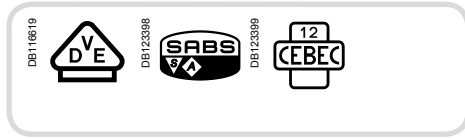

IEC/EN 60947-2
IEC/EN 60898-1



- iC60a circuit breakers are multi-standard circuit breakers which combine the following functions:
 - circuit protection against short-circuit currents,
 - circuit protection against overload currents,
 - suitable for industrial isolation according to IEC/EN 60947-2, standard.
 - fault tripping indication by a red mechanical indicator in circuit breaker front face.

Alternating current (AC) 50/60 Hz			
Breaking capacity (Icu) according to IEC/EN 60947-2			Service breaking capacity (Ics)
	Voltage (Ue)		
Ph/Ph (2P, 3P, 4P)	220 to 240 V	380 to 415 V	
Ph/N (1P)		220 to 240 V	
Rating (In) 1 to 63 A	10 kA	6 kA	100 % of Icu
Breaking capacity (Icn) according to IEC/EN 60898-1			
	Voltage (Ue)		
Ph/Ph	400 V		
Ph/N	230 V		
Rating (In) 1 to 63 A	4500 A		

Catalogue numbers

iC60a circuit breaker			
Type	1P		2P
Auxiliaries	Remote tripping and indication, pages 123 and 136		Remote tripping and indication, pages 123 and 136
Vigi iC60	Vigi iC60 add-on residual current device, page 82		Vigi iC60 add-on residual current device, page 82
Rating (In)	Quality label	Curve	Curve
		C	C
1 A		A9F64101	A9F64201
2 A		A9F64102	A9F64202
3 A		A9F64103	A9F64203
6 A		A9F64106	A9F64206
10 A		A9F64110	A9F64210
16 A		A9F64116	A9F64216
20 A		A9F64120	A9F64220
25 A		A9F64125	A9F64225
32 A		A9F64132	A9F64232
40 A		A9F64140	A9F64240
50 A		A9F64150	A9F64250
63 A		A9F64163	A9F64263
Width in 9-mm modules	2		4
Accessories	Pages 123 and 136		Pages 123 and 136

iC60a circuit breakers (curve C) (cont.)

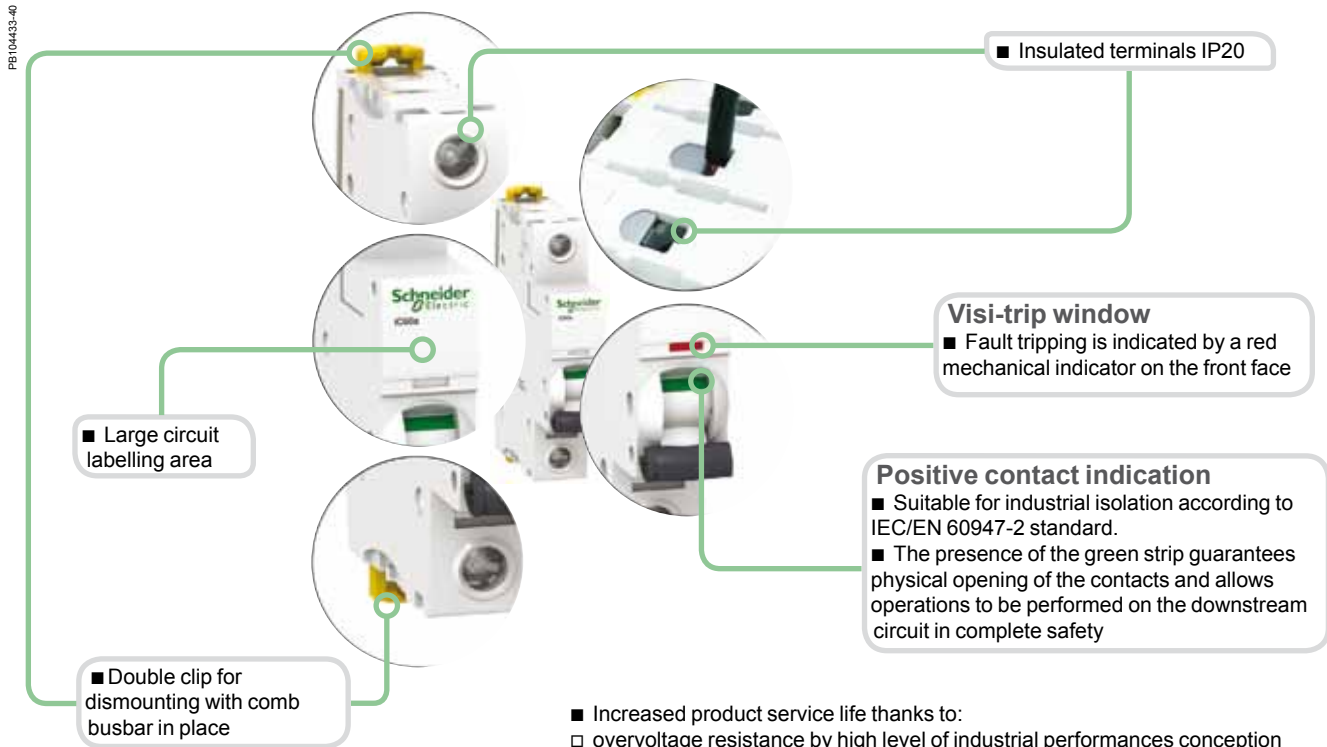





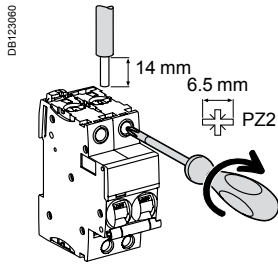

- Increased product service life thanks to:
 - overvoltage resistance by high level of industrial performances conception (pollution degree, rated impulse withstand voltage and insulation voltage),
 - high performance limitation (see limitation curves),
 - fast closing independent of the speed of actuation of the toggle.
- Remote indication, open/closed/tripped, by optional auxiliary contacts.
- Top or bottom electrical feeding.

3P	4P
Remote tripping and indication, pages 123 and 136	Remote tripping and indication, pages 123 and 136
Vigi iC60 add-on residual current device, page 82	Vigi iC60 add-on residual current device, page 82
Curve C	Curve C
A9F64301	A9F64401
A9F64302	A9F64402
A9F64303	A9F64403
A9F64306	A9F64406
A9F64310	A9F64410
A9F64316	A9F64416
A9F64320	A9F64420
A9F64325	A9F64425
A9F64332	A9F64432
A9F64340	A9F64440
A9F64350	A9F64450
A9F64363	A9F64463
6	8
Pages 123 and 136	Pages 123 and 136

iC60a circuit breakers (curve C) (cont.)

Connection



Rating	Tightening torque	Without accessory		With accessories			
		Copper cables		50 mm ² Al terminal	Multi-cables terminal		
		Rigid	Flexible or ferrule		Rigid cables	Flexible cables	
1 to 25 A	2 N.m	 DB1122945	 DB1122946	 DB1122955	 DB118789	 DB118787	
32 to 63 A	3.5 N.m	1 to 25 mm ²	1 to 16 mm ²	-	Ø 5 mm	-	
		1 to 35 mm ²	1 to 25 mm ²	50 mm ²		3 x 16 mm ²	3 x 10 mm ²

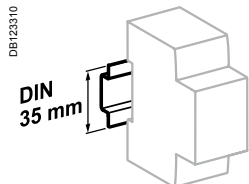

Clip on DIN rail 35 mm.

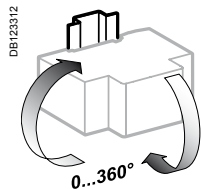

Indifferent position of installation.

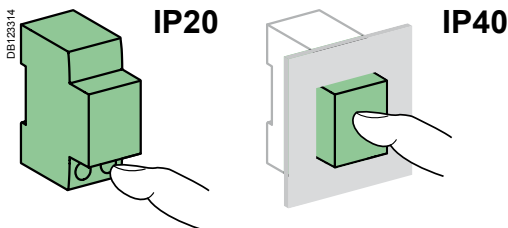

Technical data

Main characteristics		
According to IEC/EN 60947-2		
Insulation voltage (U _i)		500 V AC
Pollution degree		3
Rated impulse withstand voltage (U _{imp})		6 kV
Thermal tripping	Reference temperature	50 °C
	Temperature derating	See page 233
Magnetic tripping	C curve	8 I _n ± 20 %
Utilization category		A
According to IEC/EN 60898-1		
Limitation class		3
Rated making and breaking capacity of an individual pole (I _{cn1})		I _{cn1} = I _{cn}
Additional characteristics		
Degree of protection (IEC 60529)	Device only	IP20
	Device in modular enclosure	IP40 Insulation class II
Endurance (O-C)	Electrical	10,000 cycles
	Mechanical	20,000 cycles
Overvoltage category (IEC 60364)		IV
Operating temperature		-35 °C to +70 °C
Storage temperature		-40 °C to +85 °C
Tropicalization (IEC 60068-1)		Treatment 2 (relative humidity 95 % to 55 °C)

iC60a circuit breakers (curve C) (cont.)

Weight (g)

Circuit-breaker	
Type	iC60a
1P	125
2P	250
3P	375
4P	500

Dimensions (mm)

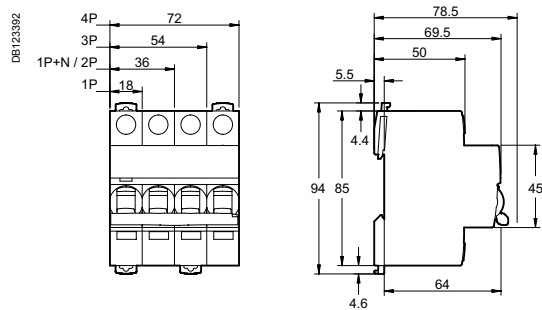

iC60N circuit breakers (curve B, C, D)

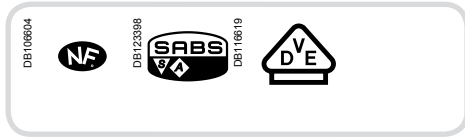

IEC/EN 60947-2 IEC/EN 60898-1

- iC60N circuit breakers are multi-standard circuit breakers which combine the following functions:
 - circuit protection against short-circuit currents,
 - circuit protection against overload currents,
 - suitable for industrial isolation according to IEC/EN 60947-2, standard.
 - fault tripping indication by a red mechanical indicator in circuit breaker front face.

Alternating current (AC) 50/60 Hz

Breaking capacity (Icu) according to IEC/EN 60947-2	Voltage (Ue)				Service breaking capacity (Ics)
	12 to 133 V	220 to 240 V	380 to 415 V	440 V	
Ph/Ph (2P, 3P, 4P)	12 to 133 V	220 to 240 V	380 to 415 V	440 V	100 % of Icu
Ph/N (1P, 1P+N)	12 to 60 V	100 to 133 V	220 to 240 V	-	
Rating (In)	0.5 to 4 A	50 kA	50 kA	50 kA	25 kA
	6 to 63 A	36 kA	20 kA	10 kA	6 kA

Breaking capacity (Icn) according to IEC/EN 60898-1

Breaking capacity (Icn) according to IEC/EN 60898-1	Voltage (Ue)	
	Ph/Ph	Ph/N
	400 V	230 V
Rating (In)	0.5 to 63 A	6000 A

Direct current (DC)

Breaking capacity (Icu) according to IEC/EN 60947-2	Voltage (Ue)				Service breaking capacity (Ics)
	12 to 72 V	100 to 133 V	220 to 250 V		
Between +/-	12 to 72 V	100 to 133 V	220 to 250 V		100 % of Icu
Number of poles	1P	2P (in series)	3P (in series)	4P (in series)	
Rating (In)	1 to 63 A	6 kA	6 kA	6 kA	

Catalogue numbers

iC60N circuit breaker

Type	1P	2P
Auxiliaries	Remote tripping and indication, pages 123 and 136	Remote tripping and indication, pages 123 and 136
Vigi iC60	Vigi iC60 add-on residual current device, page 82	Vigi iC60 add-on residual current device, page 82
Rating (In)	Curve B ⁽²⁾ C D ⁽¹⁾	Curve B ⁽²⁾ C D ⁽¹⁾
0.5 A ⁽¹⁾	A9F73170	A9F74170
1 A ⁽¹⁾	A9F73101	A9F74101
2 A ⁽¹⁾	A9F73102	A9F74102
3 A ⁽¹⁾	A9F73103	A9F74103
4 A ⁽¹⁾	A9F73104	A9F74104
6 A	A9F76106	A9F77106
10 A	A9F76110	A9F77110
13 A ⁽¹⁾	A9F73113	A9F74113
16 A	A9F76116	A9F77116
20 A	A9F76120	A9F77120
25 A	A9F76125	A9F77125
32 A	A9F76132	A9F77132
40 A	A9F76140	A9F77140
50 A	A9F76150	A9F77150
63 A	A9F76163	A9F77163
Width in 9-mm modules	2	4
Accessories	Pages 123 and 136	Pages 123 and 136

(1) VDE approved only.

(2) only NF and VDE.

iC60N circuit breakers (curve B, C, D) (cont.)

PB10454-40

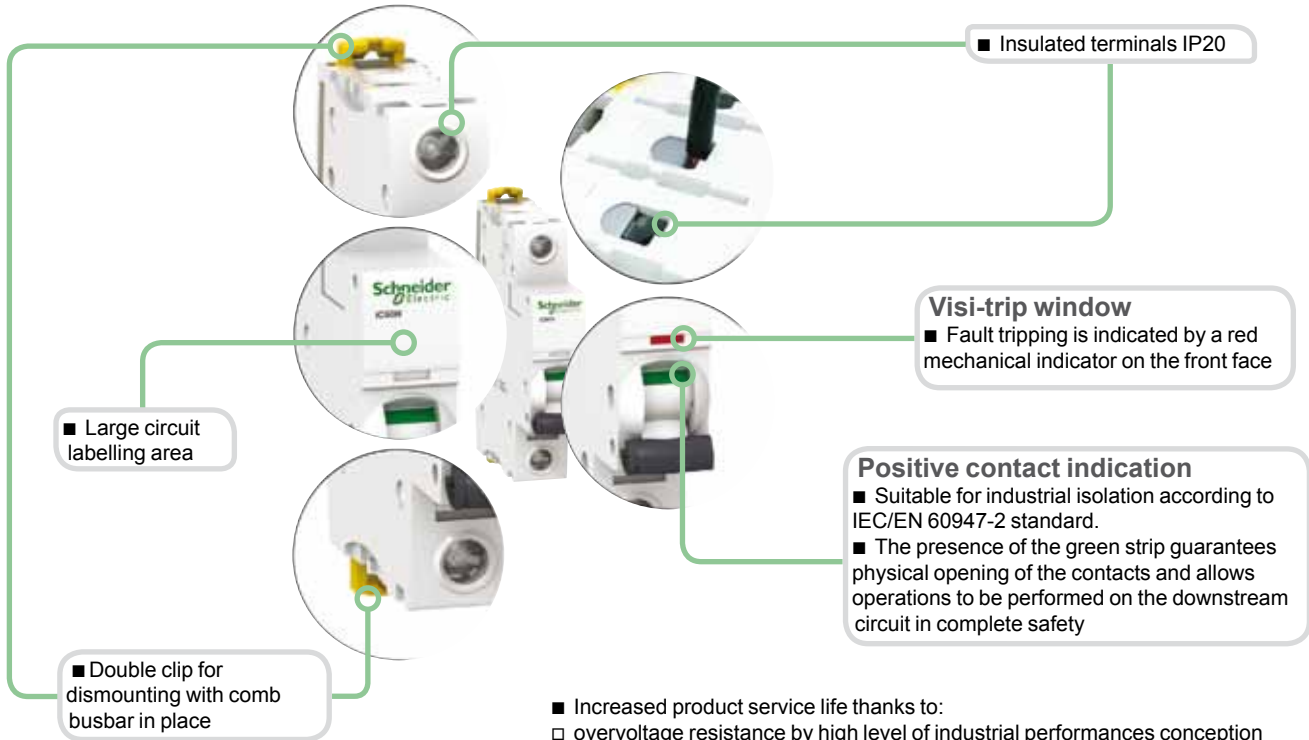

- Increased product service life thanks to:
 - overvoltage resistance by high level of industrial performances conception (pollution degree, rated impulse withstand voltage and insulation voltage),
 - high performance limitation (see limitation curves),
 - fast closing independent of the speed of actuation of the toggle.
- Remote indication, open/closed/tripped, by optional auxiliary contacts.
- Top or bottom electrical feeding.

3P				4P			
Remote tripping and indication, pages 123 and 136				Remote tripping and indication, pages 123 and 136			
Vigi iC60 add-on residual current device, page 82				Vigi iC60 add-on residual current device, page 82			
Curve				Curve			
B ⁽²⁾		C		D ⁽¹⁾			
A9F73370	A9F74370	A9F75370		A973470	A9F74470	A9F75470	
A9F73301	A9F74301	A9F75301		A9F73401	A9F74401	A9F75401	
A9F73302	A9F74302	A9F75302		A9F73402	A9F74402	A9F75402	
A9F73303	A9F74303	A9F75303		A9F73403	A9F74403	A9F75403	
A9F73304	A9F74304	A9F75304		A9F73404	A9F74404	A9F75404	
A9F76306	A9F77306	A9F75306		A9F76406	A9F77406	A9F75406	
A9F76310	A9F77310	A9F75310		A9F76410	A9F77410	A9F75410	
A9F73313	A9F74313	A9F75313		A9F73413	A9F74413	A9F75413	
A9F76316	A9F77316	A9F75316		A9F76416	A9F77416	A9F75416	
A9F76320	A9F77320	A9F75320		A9F76420	A9F77420	A9F75420	
A9F76325	A9F77325	A9F75325		A9F76425	A9F77425	A9F75425	
A9F76332	A9F77332	A9F75332		A9F76432	A9F77432	A9F75432	
A9F76340	A9F77340	A9F75340		A9F76440	A9F77440	A9F75440	
A9F76350	A9F77350	A9F75350		A9F76450	A9F77450	A9F75450	
A9F76363	A9F77363	A9F75363		A9F76463	A9F77463	A9F75463	
6				8			
Pages 123 and 136				Pages 123 and 136			

iC60N circuit breakers (curve B, C, D) (cont.)

Connection

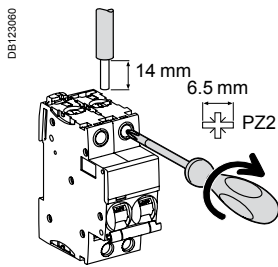

Rating	Tightening torque	Without accessory		With accessories			
		Copper cables		50 mm ² Al terminal	Screw-on connection for ring terminal	Multi-cables terminal	
		Rigid	Flexible or ferrule			Rigid cables	Flexible cables
0.5 to 25 A	2 N.m	1 to 25 mm ²	1 to 16 mm ²	-	Ø 5 mm	-	-
32 to 63 A	3.5 N.m	1 to 35 mm ²	1 to 25 mm ²	50 mm ²	-	3 x 16 mm ²	3 x 10 mm ²

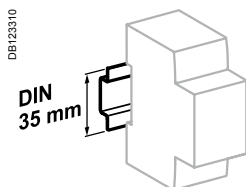

Clip on DIN rail 35 mm.

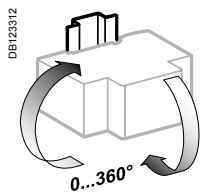

Indifferent position of installation.

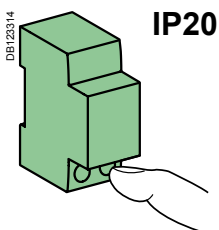

IP20

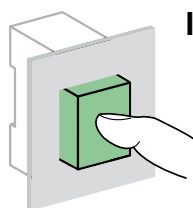

IP40

Technical data

Main characteristics

According to IEC/EN 60947-2

Insulation voltage (U _i)	500 V AC	
Pollution degree	3	
Rated impulse withstand voltage (U _{imp})	6 kV	
Thermal tripping	Reference temperature	50 °C
	Temperature derating	See page 233
Magnetic tripping	B curve	4 I _n ± 20 %
	C curve	8 I _n ± 20 %
	D curve	12 I _n ± 20 %
Utilization category	A	

According to IEC/EN 60898-1

Limitation class	3
Rated making and breaking capacity of an individual pole (I _{cn1})	I _{cn1} = I _{cn}

Additional characteristics

Degree of protection (IEC 60529)	Device only	IP20
	Device in modular enclosure	IP40 Insulation class II
Endurance (O-C)	Electrical	10,000 cycles
	Mechanical	20,000 cycles
Overvoltage category (IEC 60364)	IV	
Operating temperature	-35°C to +70°C	
Storage temperature	-40°C to +85°C	
Tropicalization (IEC 60068-1)	Treatment 2 (relative humidity 95 % to 55°C)	

iC60N circuit breakers (curve B, C, D) (cont.)

Weight (g)

Circuit-breaker	
Type	iC60N
1P	125
2P	250
3P	375
4P	500

Dimensions (mm)

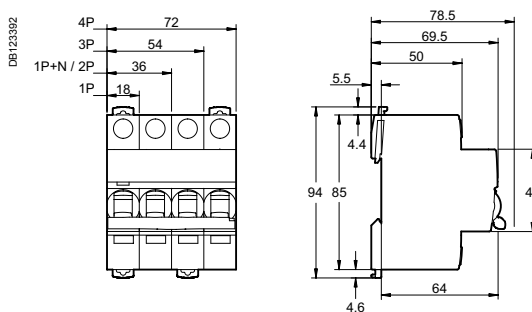

iC60H circuit breakers (curve B, C, D)



IEC/EN 60947-2 IEC/EN 60898-1

- iC60H circuit breakers are multi-standard circuit breakers which combine the following functions:
 - circuit protection against short-circuit currents,
 - circuit protection against overload currents,
 - suitable for industrial isolation according to IEC/EN 60947-2, standard.
 - fault tripping indication by a red mechanical indicator in circuit breaker front face.

Alternating current (AC) 50/60 Hz

Breaking capacity (Icu) according to IEC/EN 60947-2					Service breaking capacity (Ics)
Ph/Ph (2P, 3P, 4P)	Voltage (Ue)				
	12 to 133 V	220 to 240 V	380 to 415 V	440 V	100 % of Icu
Ph/N (1P, 1P+N)	12 to 60 V	100 to 133 V	220 to 240 V	-	
Rating (In)	0.5 to 4 A	70 kA	70 kA	50 kA	
	6 to 40 A	42 kA	30 kA	15 kA	50 % of Icu
	50/63 A	42 kA	-	15 kA	50 % of Icu

Breaking capacity (Icn) according to IEC/EN 60898-1	
	Voltage (Ue)
Ph/Ph	400 V
Ph/N	230 V
Rating (In)	0.5 to 63 A 10000 A

Direct current (DC)

Breaking capacity (Icu) according to IEC/EN 60947-2					Service breaking capacity (Ics)
	Voltage (Ue)				
Between +/-	12 to 72 V	100 to 133 V	220 to 250 V		100 % of Icu
Number of poles	1P	2P (in series)	3P (in series)	4P (in series)	
Rating (In)	1 to 63 A	10 kA	10 kA	10 kA	

Catalogue numbers

iC60H circuit breaker						
Type	1P			2P		
Auxiliaries	Remote tripping and indication, pages 123 and 136			Remote tripping and indication, pages 123 and 136		
Vigi iC60	Vigi iC60 add-on residual current device, page 82			Vigi iC60 add-on residual current device, page 82		
Rating (In)	Curve			Curve		
	B ⁽²⁾	C	D ⁽¹⁾	B ⁽²⁾	C	D ⁽¹⁾
0.5 A ⁽¹⁾	A9F83170	A9F84170	A9F85170	A9F83270	A9F84270	A9F85270
1 A ⁽¹⁾	A9F83101	A9F84101	A9F85101	A9F83201	A9F84201	A9F85201
2 A ⁽¹⁾	A9F83102	A9F84102	A9F85102	A9F83202	A9F84202	A9F85202
3 A ⁽¹⁾	A9F83103	A9F84103	A9F85103	A9F83203	A9F84203	A9F85203
4 A ⁽¹⁾	A9F83104	A9F84104	A9F85104	A9F83204	A9F84204	A9F85204
6 A	A9F86106	A9F87106	A9F85106	A9F86206	A9F87206	A9F85206
10 A	A9F86110	A9F87110	A9F85110	A9F86210	A9F87210	A9F85210
13 A ⁽¹⁾	A9F83113	A9F84113	A9F85113	A9F83213	A9F84213	A9F85213
16 A	A9F86116	A9F87116	A9F85116	A9F86216	A9F87216	A9F85216
20 A	A9F86120	A9F87120	A9F85120	A9F86220	A9F87220	A9F85220
25 A	A9F86125	A9F87125	A9F85125	A9F86225	A9F87225	A9F85225
32 A	A9F86132	A9F87132	A9F85132	A9F86232	A9F87232	A9F85232
40 A	A9F86140	A9F87140	A9F85140	A9F86240	A9F87240	A9F85240
50 A	A9F86150	A9F87150	A9F85150	A9F86250	A9F87250	A9F85250
63 A	A9F86163	A9F87163	A9F85163	A9F86263	A9F87263	A9F85263
Width in 9-mm modules	2			4		
Accessories	Pages 123 and 136			Pages 123 and 136		

(1) VDE approved only.

(2) only NF and VDE.

iC60H circuit breakers (curve B, C, D) (cont.)

PB10435-40

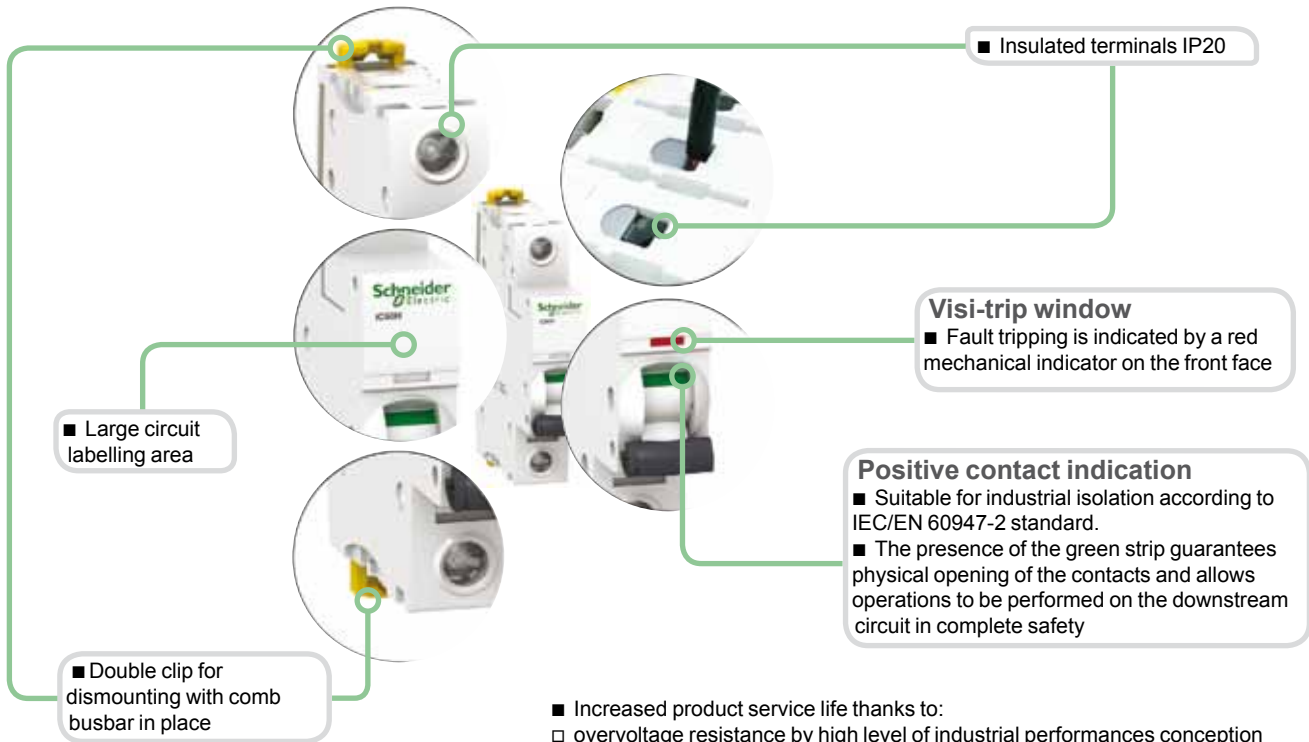

- Increased product service life thanks to:
 - overvoltage resistance by high level of industrial performances conception (pollution degree, rated impulse withstand voltage and insulation voltage),
 - high performance limitation (see limitation curves),
 - fast closing independent of the speed of actuation of the toggle.
- Remote indication, open/closed/tripped, by optional auxiliary contacts.
- Top or bottom electrical feeding.

3P			4P		
Remote tripping and indication, pages 123 and 136			Remote tripping and indication, pages 123 and 136		
Vigi iC60 add-on residual current device, page 82			Vigi iC60 add-on residual current device, page 82		
Curve			Curve		
B ⁽²⁾	C	D ⁽¹⁾	B ⁽²⁾	C	D ⁽¹⁾
A9F83370	A9F84370	A9F85370	A9F83470	A9F84470	A9F85470
A9F83301	A9F84301	A9F85301	A9F83401	A9F84401	A9F85401
A9F83302	A9F84302	A9F85302	A9F83402	A9F84402	A9F85402
A9F83303	A9F84303	A9F85303	A9F83403	A9F84403	A9F85403
A9F83304	A9F84304	A9F85304	A9F83404	A9F84404	A9F85404
A9F86306	A9F87306	A9F85306	A9F86406	A9F87406	A9F85406
A9F86310	A9F87310	A9F85310	A9F86410	A9F87410	A9F85410
A9F83313	A9F84313	A9F85313	A9F83413	A9F84413	A9F85413
A9F86316	A9F87316	A9F85316	A9F86416	A9F87416	A9F85416
A9F86320	A9F87320	A9F85320	A9F86420	A9F87420	A9F85420
A9F86325	A9F87325	A9F85325	A9F86425	A9F87425	A9F85425
A9F86332	A9F87332	A9F85332	A9F86432	A9F87432	A9F85432
A9F86340	A9F87340	A9F85340	A9F86440	A9F87440	A9F85440
A9F86350	A9F87350	A9F85350	A9F86450	A9F87450	A9F85450
A9F86363	A9F87363	A9F85363	A9F86463	A9F87463	A9F85463
6			8		
Pages 123 and 136			Pages 123 and 136		

iC60H circuit breakers (curve B, C, D) (cont.)

Connection

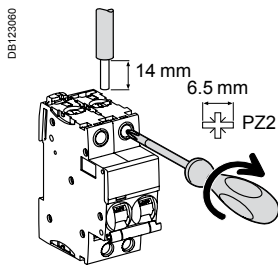

Rating	Tightening torque	Without accessory		With accessories			
		Rigid	Flexible or ferrule	50 mm ² Al terminal	Screw-on connection for ring terminal	Rigid cables	Flexible cables
0.5 to 25 A	2 N.m	1 to 25 mm ²	1 to 16 mm ²	-	Ø 5 mm	-	-
32 to 63 A	3.5 N.m	1 to 35 mm ²	1 to 25 mm ²	50 mm ²	-	3 x 16 mm ²	3 x 10 mm ²

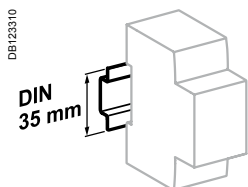

Clip on DIN rail 35 mm.

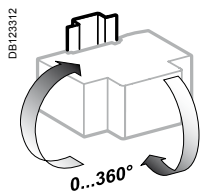

Indifferent position of installation.

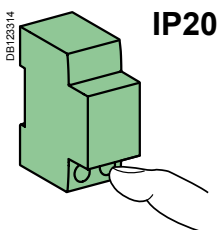

IP20

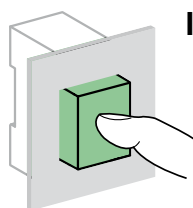

IP40

Technical data

Main characteristics

According to IEC/EN 60947-2

Insulation voltage (U _i)	500 V AC	
Pollution degree	3	
Rated impulse withstand voltage (U _{imp})	6 kV	
Thermal tripping	Reference temperature	50 °C
	Temperature derating	See page 233
Magnetic tripping	B curve	4 I _n ± 20 %
	C curve	8 I _n ± 20 %
	D curve	12 I _n ± 20 %
Utilization category	A	

According to IEC/EN 60898-1

Limitation class	3
Rated making and breaking capacity of an individual pole (I _{cn1})	I _{cn1} = I _{cn}

Additional characteristics

Degree of protection (IEC 60529)	Device only	IP20
	Device in modular enclosure	IP40
Endurance (O-C)	Electrical	10,000 cycles
	Mechanical	20,000 cycles
Overvoltage category (IEC 60364)	IV	
Operating temperature	-35°C to +70°C	
Storage temperature	-40°C to +85°C	
Tropicalization (IEC 60068-1)	Treatment 2 (relative humidity 95 % to 55°C)	

iC60H circuit breakers (curve B, C, D) (cont.)

Weight (g)

Circuit-breaker	
Type	iC60H
1P	125
2P	250
3P	375
4P	500

Dimensions (mm)

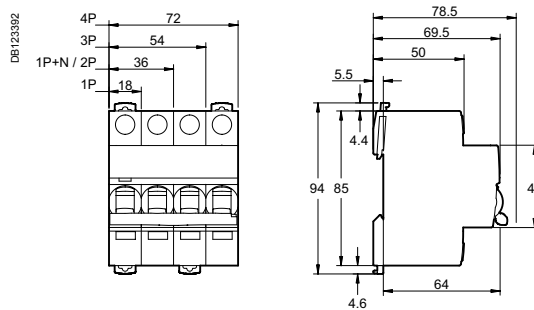

iC60L circuit breakers (curve B, C, K)



IEC/EN 60947-2
IEC/EN 60898-1 up to 40 A

- iC60L circuit breakers are multi-standard circuit breakers which combine the following functions:
 - circuit protection against short-circuit currents,
 - circuit protection against overload currents,
 - suitable for industrial isolation according to IEC/EN 60947-2, standard.
 - fault tripping indication by a red mechanical indicator in circuit breaker front face.

Alternating current (AC) 50/60 Hz

Breaking capacity (Icu) according to IEC/EN 60947-2						Service breaking capacity (Ics)
		Voltage (Ue)				
Ph/Ph (2P, 3P, 4P)		12 to 133 V	220 to 240 V	380 to 415 V	440 V	100 % of Icu
Ph/N (1P)		12 to 60 V	100 to 133 V	220 to 240 V	-	
Rating (In)	0.5 to 4 A	100 kA	100 kA	100 kA	70 kA	100 % of Icu
	6 to 25 A	70 kA	-	25 kA	20 kA	50 % of Icu ⁽¹⁾
	32 / 40 A	70 kA	-	20 kA	15 kA	50 % of Icu
	50 / 63 A	70 kA	-	15 kA	10 kA	50 % of Icu

Breaking capacity (Icn) according to IEC/EN 60898-1	
Voltage (Ue)	
Ph/Ph	400 V
Ph/N	230 V
Rating (In)	0.5 to 40 A 15000 A

Direct current (DC)

Breaking capacity (Icu) according to IEC/EN 60947-2						Service breaking capacity (Ics)
		Voltage (Ue)				
Between +/-		12 to 72 V	100 to 144 V	220 to 250 V		100 % of Icu
Number of poles		1P	2P (in series)	3P (in series)	4P (in series)	
Rating (In)	1 to 63 A	15 kA	15 kA	15 kA	15 kA	

Catalogue numbers

iC60L circuit breaker							
Type	1P			2P			
Auxiliaries	Remote tripping and indication, pages 123 and 136			Remote tripping and indication, pages 123 and 136			
Vigi iC60	Vigi iC60 add-on residual current device, page 82			Vigi iC60 add-on residual current device, page 82			
Rating (In)	Quality label ⁽²⁾	Curve			Curve		
		B	C	K	B	C	K
0.5 A		A9F93170	A9F94170	A9F95170	A9F93270	A9F94270	A9F95270
1 A		A9F93101	A9F94101	A9F95101	A9F93201	A9F94201	A9F95201
1.6 A		-	-	A9F95172	-	-	A9F95272
2 A		A9F93102	A9F94102	A9F95102	A9F93202	A9F94202	A9F95202
3 A		A9F93103	A9F94103	A9F95103	A9F93203	A9F94203	A9F95203
4 A		A9F93104	A9F94104	A9F95104	A9F93204	A9F94204	A9F95204
6 A		A9F93106	A9F94106	A9F95106	A9F93206	A9F94206	A9F95206
10 A		A9F93110	A9F94110	A9F95110	A9F93210	A9F94210	A9F95210
16 A		A9F93116	A9F94116	A9F95116	A9F93216	A9F94216	A9F95216
20 A		A9F93120	A9F94120	A9F95120	A9F93220	A9F94220	A9F95220
25 A		A9F93125	A9F94125	A9F95125	A9F93225	A9F94225	A9F95225
32 A		A9F93132	A9F94132	A9F95132	A9F93232	A9F94232	A9F95232
40 A		A9F93140	A9F94140	A9F95140	A9F93240	A9F94240	A9F95240
50 A		A9F93150	A9F94150	A9F95150 ⁽³⁾	A9F93250	A9F94250	A9F95250
63 A		A9F93163	A9F94163	A9F95163 ⁽³⁾	A9F93263	A9F94263	A9F95263
Width in 9-mm modules	2			4			
Accessories	Pages 123 and 136			Pages 123 and 136			

(1) 100 % of Icu for ratings 6 to 25 A under Ue 100 to 133 V AC Ph/Ph and Ue 12 to 60 V AC Ph/N.
 (2) Information to be provided by the country.
 (3) Without approval.

iC60L circuit breakers (curve B, C, K) (cont.)

PS 104436-40

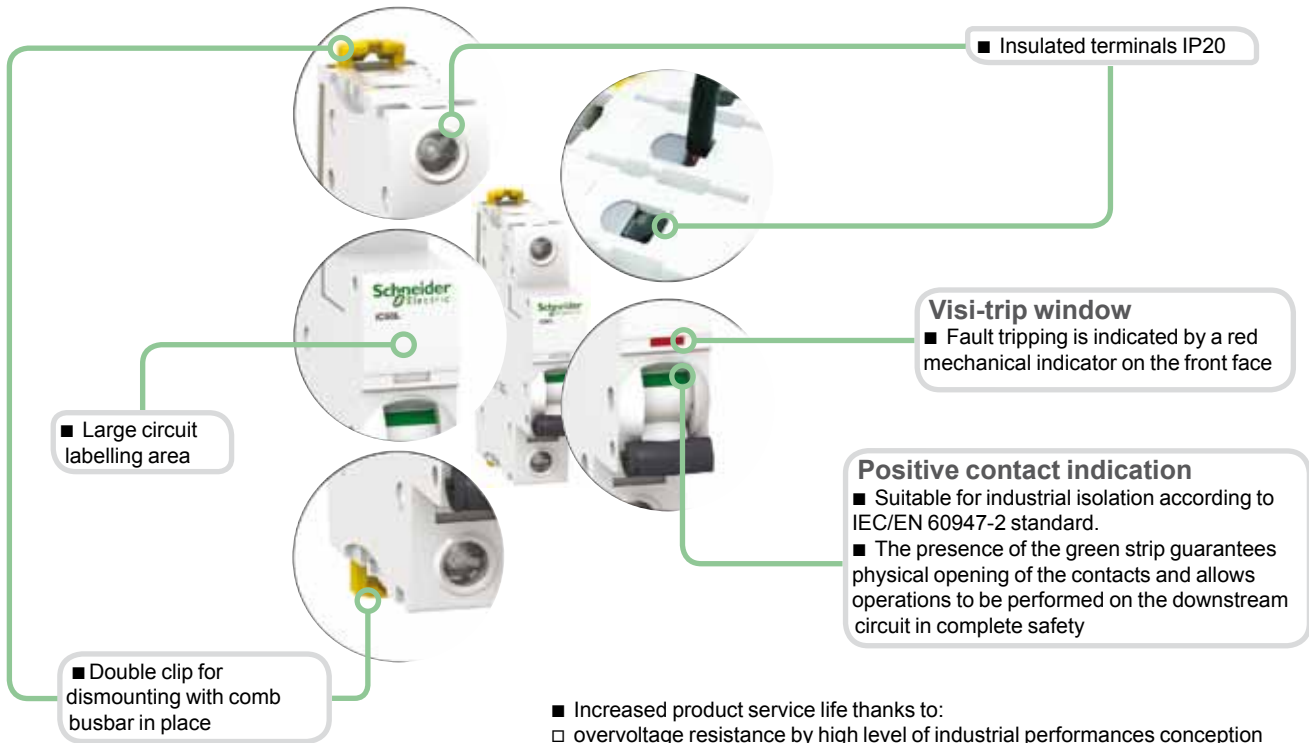

- Increased product service life thanks to:
 - overvoltage resistance by high level of industrial performances conception (pollution degree, rated impulse withstand voltage and insulation voltage),
 - high performance limitation (see limitation curves),
 - fast closing independent of the speed of actuation of the toggle.
- Remote indication, open/closed/tripped, by optional auxiliary contacts.
- Top or bottom electrical feeding.

3P			4P		
Remote tripping and indication, pages 123 and 136			Remote tripping and indication, pages 123 and 136		
Vigi iC60 add-on residual current device, page 82			Vigi iC60 add-on residual current device, page 82		
Curve			Curve		
B	C	K	B	C	K
A9F93370	A9F94370	A9F95370	A9F93470	A9F94470	A9F95470
A9F93301	A9F94301	A9F95301	A9F93401	A9F94401	A9F95401
-	-	A9F95372	-	-	A9F95472
A9F93302	A9F94302	A9F95302	A9F93402	A9F94402	A9F95402
A9F93303	A9F94303	A9F95303	A9F93403	A9F94403	A9F95403
A9F93304	A9F94304	A9F95304	A9F93404	A9F94404	A9F95404
A9F93306	A9F94306	A9F95306	A9F93406	A9F94406	A9F95406
A9F93310	A9F94310	A9F95310	A9F93410	A9F94410	A9F95410
A9F93316	A9F94316	A9F95316	A9F93416	A9F94416	A9F95416
A9F93320	A9F94320	A9F95320	A9F93420	A9F94420	A9F95420
A9F93325	A9F94325	A9F95325	A9F93425	A9F94425	A9F95425
A9F93332	A9F94332	A9F95332	A9F93432	A9F94432	A9F95432
A9F93340	A9F94340	A9F95340	A9F93440	A9F94440	A9F95440
A9F93350	A9F94350	A9F95350	A9F93450	A9F94450	A9F95450
A9F93363	A9F94363	A9F95363	A9F93463	A9F94463	A9F95463
4			6		
Pages 123 and 136			Pages 123 and 136		

iC60L circuit breakers (curve B, C, K) (cont.)

Connection

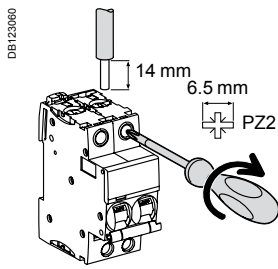

Rating	Tightening torque	Without accessory		With accessories			
		Rigid	Flexible or ferrule	50 mm ² Al terminal	Screw-on connection for ring terminal	Rigid cables	Flexible cables
0.5 to 25 A	2 N.m	1 to 25 mm ²	1 to 16 mm ²	-	Ø 5 mm	-	-
32 to 63 A	3.5 N.m	1 to 35 mm ²	1 to 25 mm ²	50 mm ²	-	3 x 16 mm ²	3 x 10 mm ²

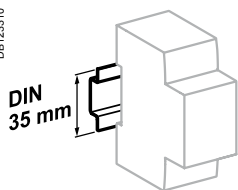

Clip on DIN rail 35 mm.

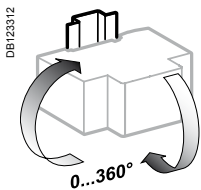

Indifferent position of installation.

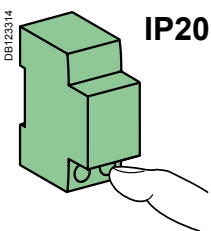

IP20

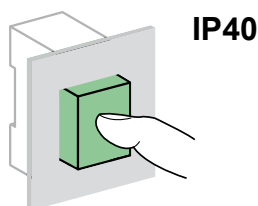

IP40

Technical data

Main characteristics

According to IEC/EN 60947-2

Insulation voltage (U _i)	500 V AC	
Pollution degree	3	
Rated impulse withstand voltage (U _{imp})	6 kV	
Thermal tripping	Reference temperature	50 °C
	Temperature derating	See page 233
Magnetic tripping	B curve	4 I _n ± 20 %
	C curve	8 I _n ± 20 %
	K curve	12 I _n ± 20 %
Utilization category	A	

According to IEC/EN 60898-1

Limitation class	3	
Rated making and breaking capacity of an individual pole (I _{cn1})	I _{cn1} = I _{cn}	

Additional characteristics

Degree of protection (IEC 60529)	Device only	IP20
	Device in modular enclosure	IP40 Insulation class II
Endurance (O-C)	Electrical	10,000 cycles
	Mechanical	20,000 cycles
Overvoltage category (IEC 60364)	IV	
Operating temperature	-35°C to +70°C	
Storage temperature	-40°C to +85°C	
Tropicalization (IEC 60068-1)	Treatment 2 (relative humidity 95 % to 55°C)	

iC60L circuit breakers (curve B, C, K) (cont.)

Weight (g)

Circuit-breaker	
Type	iC60L
1P	125
2P	250
3P	375
4P	500

Dimensions (mm)

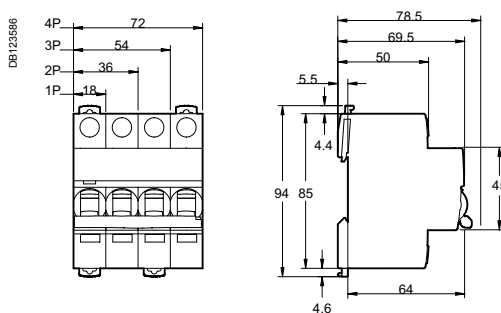

iC60L circuit breakers instantaneous circuit breakers (curve MA)

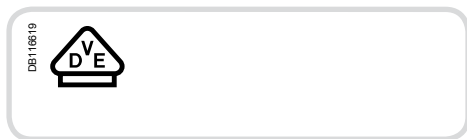

IEC/EN 60947-2



- iC60L curve MA circuit breakers combine the following functions:
 - circuit protection against short-circuit currents,
 - suitability for industrial isolation according to IEC/EN 60947-2, standard,
 - fault tripping indication by a red mechanical indicator in circuit breaker front face,
 - to be associated with overload protection for motor.

Alternating current (AC) 50/60 Hz					
Breaking capacity (Icu) according to IEC/EN 60947-2				Service breaking capacity (Ics)	
Ph/Ph (2P, 3P, 4P)	Voltage (Ue)				
Rating (In)	1.6 to 4 A	220 to 240 V	380 to 415 V	440 V	50 % of Icu
	6.3 to 25 A	50 kA	25 kA	20 kA	50 % of Icu
	40 A	36 kA	20 kA	15 kA	50 % of Icu

Catalogue numbers

iC60L instantaneous trip circuit breaker				
Type	2P		3P	
Auxiliaries	Remote tripping and indication, pages 123 and 136		Remote tripping and indication, pages 123 and 136	
Vigi iC60	Vigi iC60 add-on residual current device, page 82		Vigi iC60 add-on residual current device, page 82	
Rating (In)	Quality label ⁽¹⁾	Curve MA	Curve MA	
1.6 A		A9F90272	A9F90372	
2.5 A		A9F90273	A9F90373	
4 A		A9F90204	A9F90304	
6.3 A		A9F90276	A9F90376	
10 A		A9F90210	A9F90310	
12.5 A		A9F90282	A9F90382	
16 A		A9F90216	A9F90316	
25 A		A9F90225	A9F90325	
40 A		A9F90240	A9F90340	
Width in 9-mm modules	4		6	
Accessories	Pages 123 and 136		Pages 123 and 136	

(1) Information to be provided by the country.

iC60L circuit breakers instantaneous circuit breakers (curve MA) (cont.)

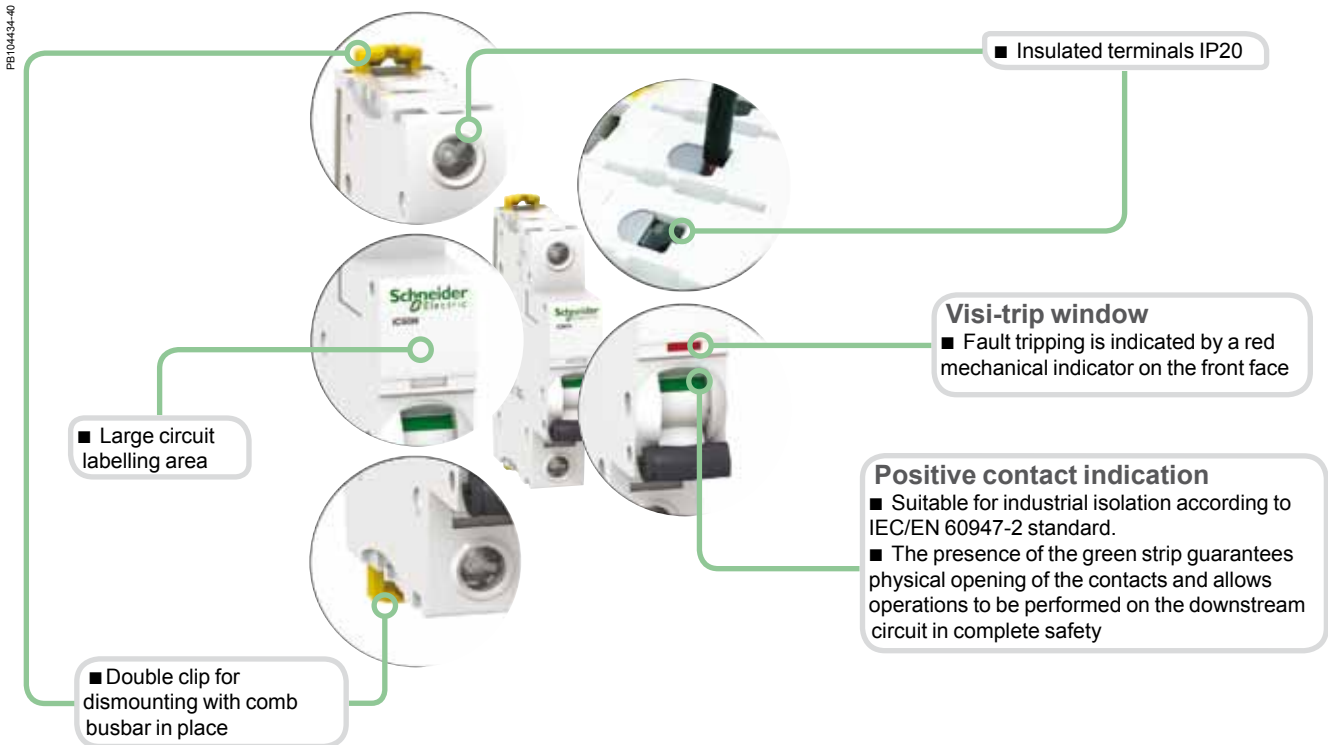

- Increased product service life thanks to:
 - overvoltage resistance by high level of industrial performances conception (pollution degree, rated impulse withstand voltage and insulation voltage),
 - high performance limitation (see limitation curves),
 - fast closing independent of the speed of actuation of the toggle.
- Remote indication, open/closed/tripped, by optional auxiliary contacts.
- Top or bottom electrical feeding.

iC60L circuit breakers instantaneous circuit breakers (curve MA) (cont.)

Connection

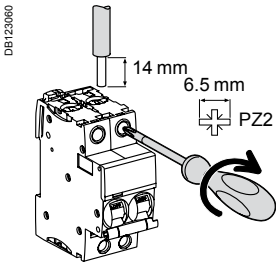

Rating	Tightening torque	Without accessory		With accessories				
		Copper cables		50 mm ² Al terminal	Screw-on connection for ring terminal		Multi-cables terminal	
		Rigid	Flexible or ferrule		Rigid cables	Flexible cables		
1.6 to 25 A	2 N.m	DB122945 1 to 25 mm ²	DB122946 1 to 16 mm ²	-	DB118789 Ø 5 mm	-	-	
40 A	3.5 N.m	1 to 35 mm ²	1 to 25 mm ²	50 mm ²	-	3 x 16 mm ²	3 x 10 mm ²	

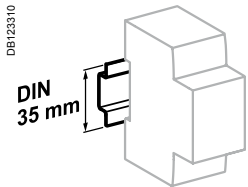

Clip on DIN rail 35 mm.

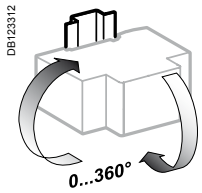

Indifferent position of installation.

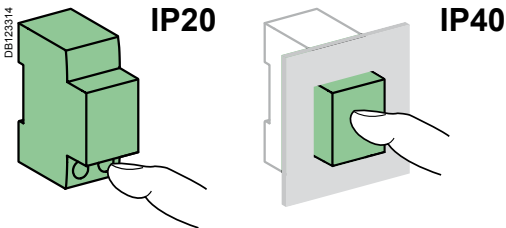

Technical data

Main characteristics		
According to IEC/EN 60947-2		
Insulation voltage (U _i)		500 V AC
Pollution degree		3
Rated impulse withstand voltage (U _{imp})		6 kV
Thermal tripping	Reference temperature	50 °C
	Temperature derating	See page 233
Magnetic tripping	MA curve	12 I _n ± 20 %
Utilization category		A
Additional characteristics		
Degree of protection (IEC 60529)	Device only	IP20
	Device in modular enclosure	IP40 Insulation class II
Endurance (O-C)	Electrical	10,000 cycles
	Mechanical	20,000 cycles
Overvoltage category (IEC 60364)		IV
Operating temperature		-35°C to +70°C
Storage temperature		-40°C to +85°C
Tropicalization (IEC 60068-1)		Treatment 2 (relative humidity 95 % to 55°C)

iC60L circuit breakers instantaneous circuit breakers (curve MA) (cont.)

Weight (g)

Circuit-breaker	
Type	iC60L
2P	250
3P	375

Dimensions (mm)

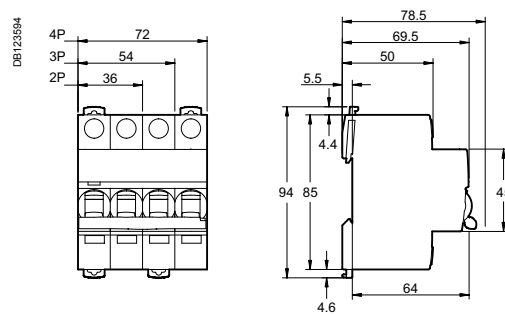



IEC/EN 60947-2, GB 14048.2, UL1077 (Supplementary Protector TC 3)

The C60H-DC supplementary protectors are used in direct current circuits (Industrial control and automations, transport, renewable energy...). They combine the following functions of circuit protection against short-circuit and overload currents, control and isolation.

Catalogue numbers

C60H-DC			
Operating voltage (Ue)	12...250 V DC		12...500 V DC
Rated voltage (Un)	250 V DC		500 V DC
Number of poles	1P		2P
Curve	C		C
Number of modules of 9 mm	2		4
Diagrams	<p>DB116587</p> <p>Supply from above or below, observing the polarity</p>		<p>DB116588</p> <p>Supply from above or Supply from below</p>
Standards	UL1077	IEC 60947-2 EN 60947-2 GB 14048.2	UL1077 IEC 60947-2 EN 60947-2 GB 14048.2
Breaking capacity	5 kA / 250 V DC	20 kA / 110 V DC 10 kA / 220 V DC 6 kA / 250 V DC	5 kA / 500 V DC 20 kA / 220 V DC 10 kA / 440 V DC 6 kA / 500 V DC
Rating (A)*	UL 1077, IEC 60947-2, EN 60947-2, GB 14048.2		
0.5	MGN61500		MGN61520
1	MGN61501		MGN61521
2	MGN61502		MGN61522
3	MGN61503		MGN61523
4	MGN61504		MGN61524
5	MGN61505		MGN61525
6	MGN61506		MGN61526
10	MGN61508		MGN61528
13	MGN61509		MGN61529
15	MGN61510		MGN61530
16	MGN61511		MGN61531
20	MGN61512		MGN61532
25	MGN61513		MGN61533
30	MGN61514		MGN61534
32	MGN61515		MGN61535
40	MGN61517		MGN61537
Rating (A)*	IEC 60947-2, EN 60947-2, GB 14048.2		
50	MGN61518		MGN61538
63	MGN61519		MGN61539

* At 25°C / 77°F see temperature derating module 92515.



DC circuit supplementary protectors for feeders / distribution systems

C60H-DC (cont.) C curve

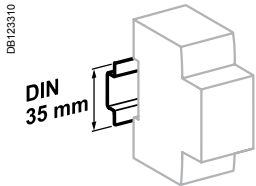

Clip on DIN rail 35 mm.

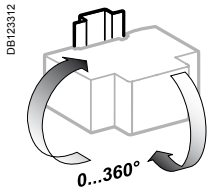

Indifferent position of installation.

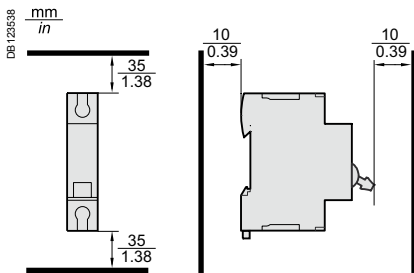
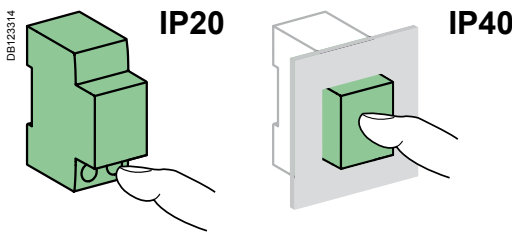

Details of minimum distance between circuit-breaker and earthed metal parts for circuit-breaker intended for use without enclosure.

Technical data

- Tripping curves: C curve - Overcurrent protection for any type of application.
- Positive break indication - the green strip indicates that all the poles are open and allows work to be carried out on the downstream circuit in complete safety.
- Suitable for isolation as defined in IEC / EN 60947-2.
- Increase in the service life of the product: thanks to fast closure independent of the speed of action on the handle.
- Current limitation in the event of a fault: fast opening of the contacts prevents the loads from being destroyed in the event of a short-circuit.

Main characteristics	
Rated service breaking capacity (Ics)	75 % of the ultimate breaking capacity (Icu)
Power loss	See module 92517
Magnetic tripping (Ii)	8.5 In (± 20 %) (compatible with curve C)
Rated impulse withstand voltage (Uimp) under frame	6 kV
Insulation voltage (Ui)	500 V DC
Endurance (O-C)	
Electrical	3,000 cycles (where L/R=2 ms) 6,000 cycles where the circuit is resistive
Mechanical	20,000 cycles
Additional characteristics	
Pollution degree	3
Utilization category	A (no delay in accordance with IEC/EN 60947-2 standards)
Tropicalization (IEC 60068-2 and GB 14048.2)	Relative humidity: 95 % at 55°C / 131°F
Operating temperature	-25°C to 70°C / -13°F to 158°F
Storage temperature	-40°C to 85°C / -40°F to 185°F



Failure to match polarity during connection may lead to a fire hazard and/or serious injury.

- The connection polarity must be observed (marked on the front panel).
- Use only with direct current.
- If two poles are used in series for the American network, use at least a 12 inch / 30 cm cable.

Weight (g)

Circuit-breaker	
Type	C60H-DC
1P	128 g / 4.51 oz
2P	256 g / 9.03 oz

Dimensions (mm/in)

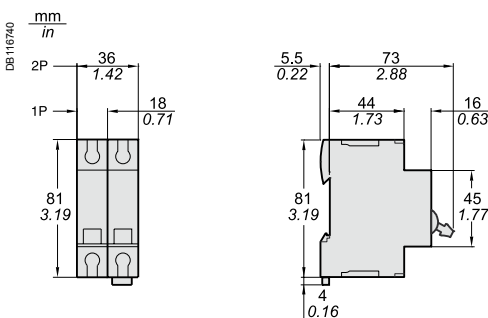

C60H-DC

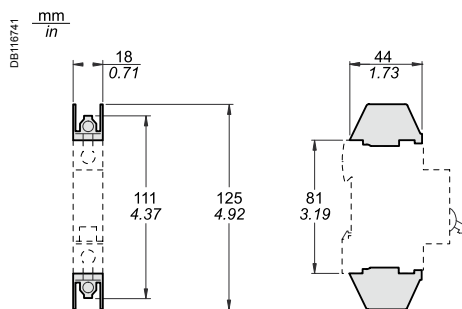

Kit for ring terminals

Connection

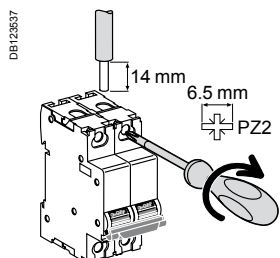

Rating	Tightening torque	Without accessory		With accessories			
		Copper cables		50 mm ² Al terminal	Screw-on connection for ring terminal	Multi-cables terminal	
		Rigid / Stranded	Flexible or ferrule			Rigid cables	Flexible cables
≤ 25 A	2.5 N.m / 22 lb.in	DB122845 1 to 25 mm ² #18 - #4 AWG	DB122846 1 to 16 mm ² #18 - #6 AWG	DB122835 50 mm ² 1 AWG	DB118789 Ø 5 mm	DB118787 3 x 16 mm ² 3 x 6 AWG	3 x 10 mm ² 3 x 8 AWG
> 25 A	3.5 N.m / 31 lb.in	1 to 35 mm ² #18 - #2 AWG	1 to 25 mm ² #18 - #4 AWG	-			

1	Insulated connector	see module 91906
2	Comb busbar	see module 91906
3	Terminal 50 mm ² Al / Cu	27060
4	Ring tongue terminal screw connection	27053
5	Ring tongue terminal connections kit Ø 5 mm, (upstream/downstream)	17400
6	Insulated distribution terminal	4 pieces 19091 3 pieces 19096

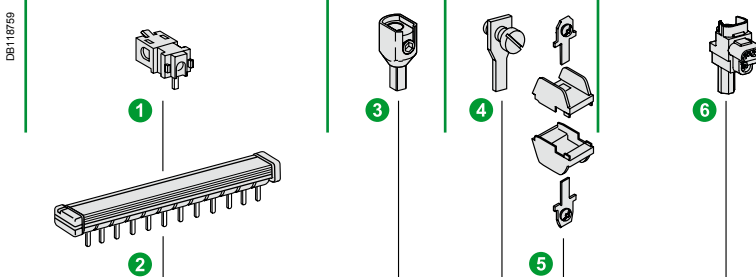

Mounting accessories

7	Sealable terminal shield	26976
8	Inter-pole barrier	27001
9	Rotary handle	
	Switching sub-assembly	27046
	Disconnectable handle	27047
	Fixed handle	27048
10	Screw shield	26981
11	Padlocking accessory (to be locked in the "open" position)	26970
12	Spacer	27062
13	Dividable mounting plate	26996
14	Marker strip	see module 91900

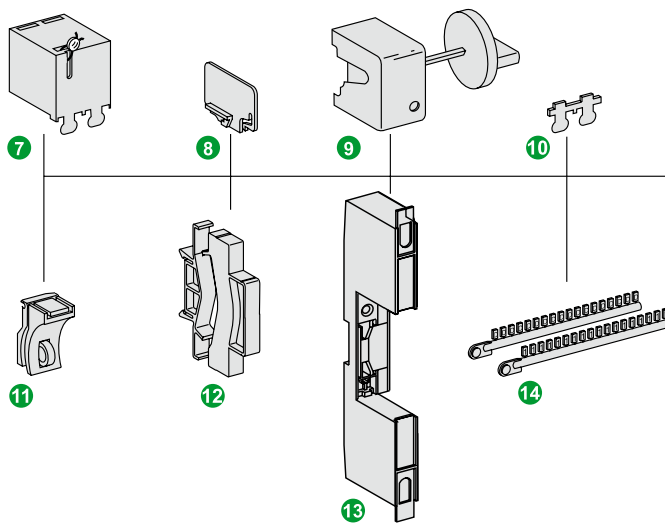

Electrical auxiliaries

Indication		
15	SD fault indicating switch	see module 90081
16	OF open/closed contact	see module 90081
Tripping		
17	MN undervoltage release	see module 90081
18	MX + OF shunt release	see module 90081

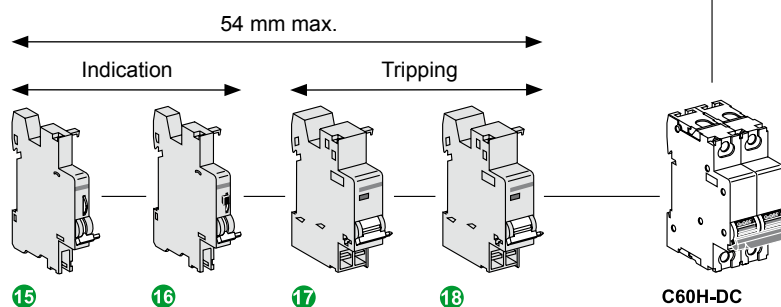

- The electrical auxiliaries must be installed to the left of the circuit breaker and within a width of 54 mm.
- If the auxiliary SD contacts are associated with the tripping auxiliaries (MN, MX, etc.), they must be installed to the left of these auxiliaries.

Poles connected in series

Network selection			
Type	Earthed		Isolated from earth
Source	Earthed polarity + or -	Earthed central point	Isolated polarities
Protected polarities	1 (1P isolation)	2	2
Diagrams (and type of faults)	<p>DB116851</p> <p><i>Example : negative polarity to the earth</i></p>	<p>DB116852</p>	<p>DB116853</p>

Selection of supplementary protector and pole connection			
24 V ≤ Un ≤ 250 V	Single-pole	Two-pole	Two-pole
Upstream connection	Only if L+ polarity is earthed	<p>DB116735</p>	<p>DB116735</p>
Downstream connection	<p>DB116752</p>	<p>DB116738</p>	<p>DB116738</p>
250 V < Un ≤ 500 V	Two-pole	Two-pole	Two-pole
Upstream connection	<p>DB116736</p>	<p>DB116735</p>	<p>DB116735</p>
Downstream connection	<p>DB116737</p>	<p>DB116738</p>	<p>DB116738</p>

Fault analysis (low earth connection resistance)			
Fault A	<p>b I_{sc} maximum at U</p> <p>b Only protected polarity concerned</p> <p>b All the poles of the protected polarity must have a breaking capacity ≥ I_{sc} max. at U</p>	<p>b I_{sc} maximum at U/2</p> <p>b Only positive polarity concerned</p> <p>b All the positive polarity poles must have a breaking capacity ≥ I_{sc} max. at U/2</p>	<p>b Not relevant</p> <p>b The fault must be indicated by a permanent insulation monitor (PIM) and cleared (IEC/EN 60364)</p>
Fault B	<p>b I_{sc} maximum at U</p> <p>b If one polarity (in this case positive) is protected: all the poles of this polarity must have a breaking capacity ≥ I_{sc} max. at U</p> <p>b If two polarities are protected, to ensure isolation: all the protections of the two polarities must have a breaking capacity ≥ I_{sc} max. at U</p>	<p>b I_{sc} maximum at U</p> <p>b The 2 polarities are concerned</p> <p>b All the poles of the two polarities must have a breaking capacity ≥ I_{sc} max. at U</p>	<p>b I_{sc} maximum at U</p> <p>b The 2 polarities are concerned</p> <p>b All the poles of the two polarities must have a breaking capacity ≥ I_{sc} max. at U</p>
Fault C		<p>b As for fault A</p> <p>b All the negative polarity poles must have a breaking capacity ≥ I_{sc} max. at U/2</p>	<p>b As for fault A with the same requirements</p>

Curves

Tripping curves

C curve as in standard IEC 60947.2

- The operating range of the magnetic release is as follows between 7 I_n and 10 I_n.
- The curves show the cold thermal tripping limits when poles are charged and the electromagnetic tripping limits with 2 charged poles.
- The curves are used without any derating.

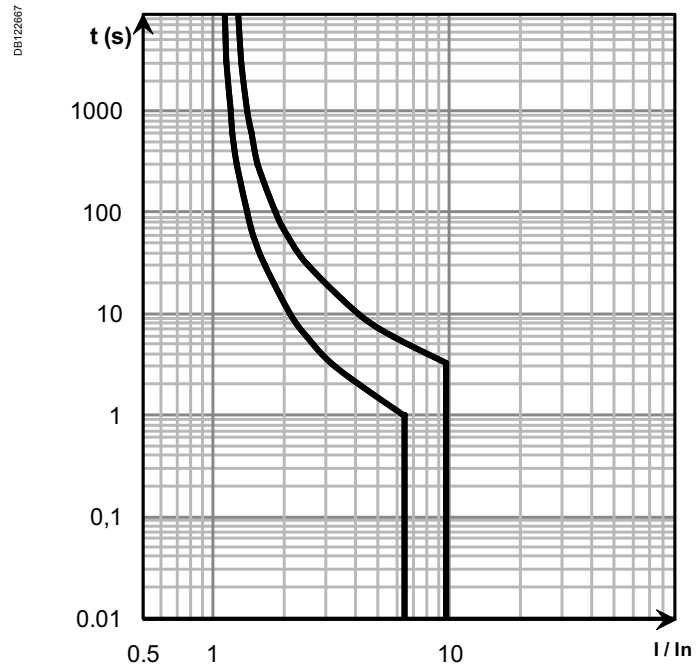

Short circuit current limiting

220 V with 1P, 440 V with 2P

250 V with 1P, 500 V with 2P

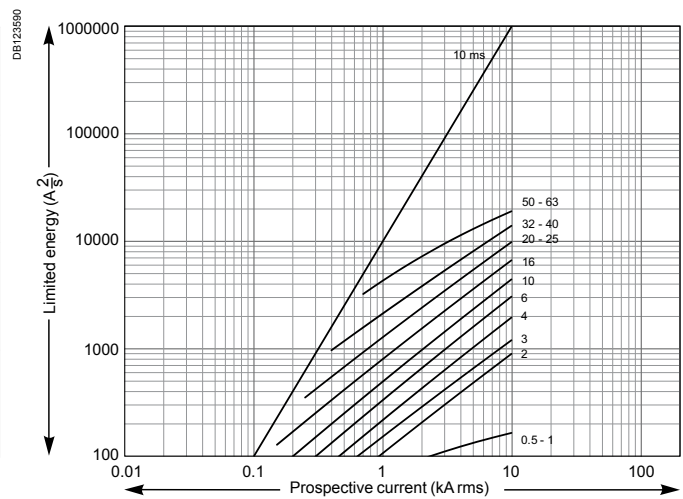
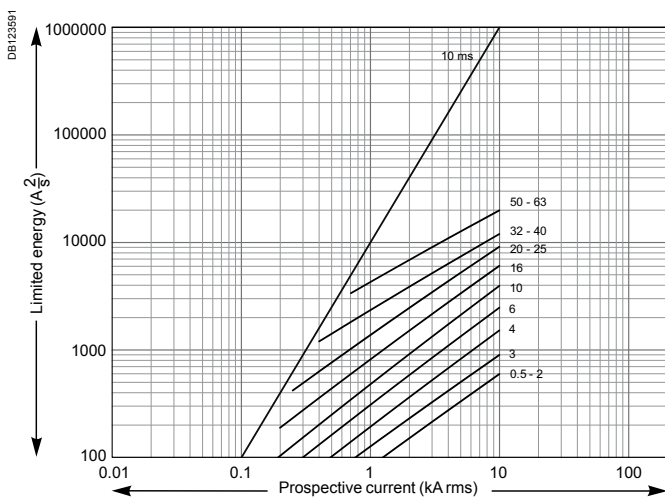

Curves (cont.)

Thermal stress limitation curve

220 V with 1P, 440 V with 2P

250 V with 1P, 500 V with 2P

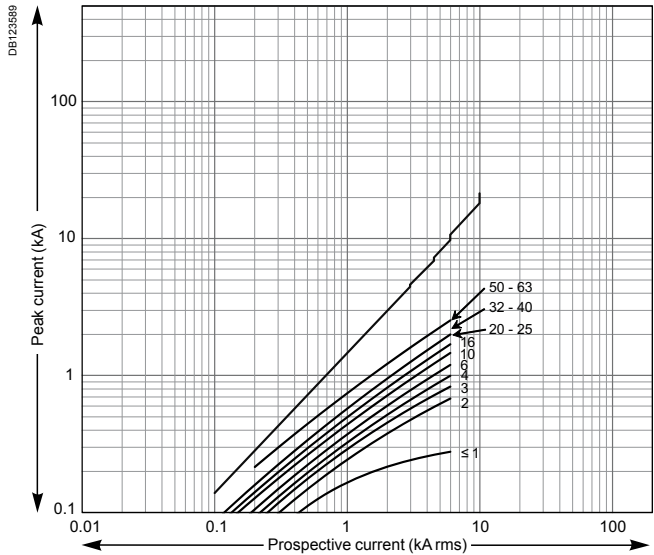
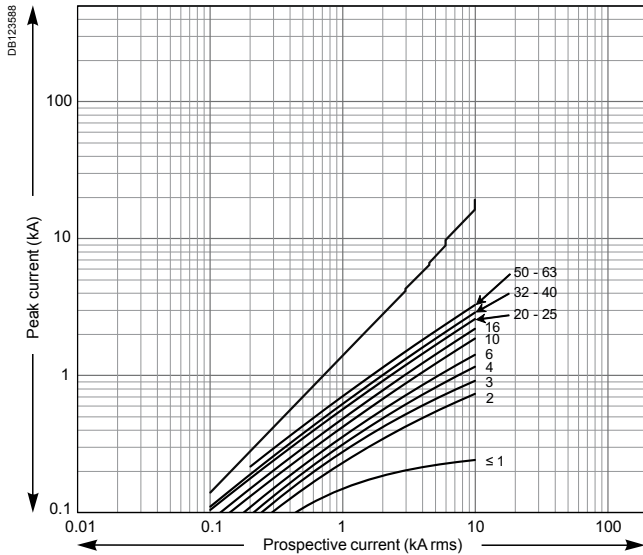

Temperature derating (according to UL 1077/ CSA22.2/ UL489A/ UL489/ IEC 60947-2 standards)

The maximum permissible current in a device depends on the ambient temperature in which it is placed. Ambient temperature is the temperature inside the enclosure or switchboard in which the devices have been installed.

The reference temperature is in the coloured column.



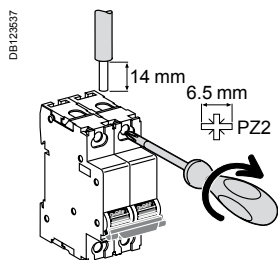

When several simultaneously operating devices are mounted side by side in a small enclosure, the temperature rise inside the enclosure causes a reduction in the current rating. A reduction coefficient of the order of 0.8 must therefore be allocated to the rating (already derated if it depends on the ambient temperature).

Temperature (°C)	-30	-25	-20	-15	-10	-5	0	5	10	15	20	25	30	35	40	45	50	55	60	65	70	
Ratings (A)																						
0.5	0.63	0.62	0.61	0.60	0.59	0.58	0.56	0.55	0.54	0.53	0.51	0.5	0.49	0.47	0.46	0.44	0.43	0.41	0.39	0.38	0.36	
1	1.18	1.17	1.15	1.14	1.12	1.10	1.09	1.07	1.05	1.04	1.02	1	0.98	0.96	0.94	0.92	0.90	0.88	0.86	0.84	0.82	
1.2	1.45	1.43	1.41	1.39	1.37	1.34	1.32	1.30	1.27	1.25	1.22	1.2	1.17	1.15	1.12	1.09	1.07	1.04	1.01	0.98	0.95	
1.5	1.86	1.83	1.80	1.77	1.74	1.71	1.67	1.64	1.61	1.57	1.54	1.5	1.46	1.42	1.39	1.34	1.30	1.26	1.22	1.17	1.12	
2	2.54	2.50	2.45	2.41	2.36	2.31	2.26	2.21	2.16	2.11	2.06	2	1.94	1.88	1.82	1.76	1.70	1.63	1.56	1.48	1.41	
3	3.78	3.71	3.65	3.58	3.51	3.45	3.38	3.30	3.23	3.16	3.08	3	2.92	2.84	2.75	2.66	2.57	2.48	2.38	2.27	2.17	
4	5.08	4.99	4.90	4.81	4.71	4.62	4.52	4.42	4.32	4.22	4.11	4	3.89	3.77	3.65	3.53	3.40	3.27	3.13	2.98	2.83	
5	6.00	5.92	5.83	5.74	5.66	5.57	5.48	5.39	5.29	5.20	5.10	5	4.90	4.80	4.69	4.58	4.47	4.36	4.24	4.12	4.00	
6	7.26	7.15	7.04	6.94	6.83	6.71	6.60	6.48	6.37	6.25	6.12	6	5.87	5.74	5.61	5.47	5.33	5.19	5.04	4.89	4.73	
7	8.76	8.62	8.47	8.32	8.17	8.01	7.85	7.69	7.52	7.35	7.18	7	6.82	6.63	6.44	6.24	6.03	5.82	5.60	5.37	5.13	
8	9.64	9.50	9.36	9.22	9.08	8.93	8.78	8.63	8.48	8.32	8.16	8	7.83	7.67	7.49	7.31	7.13	6.95	6.76	6.56	6.36	
10	12.59	12.38	12.16	11.94	11.71	11.49	11.25	11.01	10.77	10.52	10.26	10	9.73	9.45	9.17	8.87	8.57	8.25	7.92	7.58	7.22	
13	15.49	15.28	15.07	14.85	14.63	14.41	14.19	13.96	13.72	13.49	13.25	13	12.75	12.49	12.23	11.97	11.69	11.41	11.13	10.83	10.53	
15	18.61	18.31	18.01	17.70	17.38	17.06	16.74	16.40	16.07	15.72	15.36	15	14.63	14.25	13.85	13.45	13.03	12.60	12.16	11.69	11.21	
16	19.43	19.14	18.85	18.55	18.25	17.95	17.64	17.32	17.00	16.68	16.34	16	15.65	15.29	14.93	14.56	14.17	13.78	13.37	12.95	12.52	
20	24.06	23.72	23.37	23.02	22.67	22.31	21.94	21.56	21.18	20.80	20.40	20	19.59	19.17	18.74	18.30	17.85	17.39	16.92	16.43	15.93	
25	30.35	29.91	29.45	28.99	28.52	28.05	27.56	27.07	26.57	26.06	25.53	25	24.46	23.90	23.33	22.74	22.14	21.53	20.89	20.24	19.56	
30	37.35	36.74	36.12	35.50	34.86	34.21	33.54	32.86	32.17	31.46	30.74	30	29.24	28.46	27.66	26.83	25.98	25.10	24.19	23.24	22.25	
32	38.45	37.91	37.36	36.80	36.24	35.66	35.08	34.48	33.88	33.27	32.64	32	31.35	30.68	30.00	29.31	28.59	27.86	27.11	26.34	25.54	
35	44.15	43.40	42.63	41.86	41.06	40.25	39.42	38.58	37.72	36.83	35.93	35	34.05	33.06	32.05	31.01	29.93	28.81	27.64	26.42	25.14	
40	48.92	48.17	47.42	46.65	45.87	45.08	44.28	43.45	42.62	41.76	40.89	40	39.09	38.16	37.20	36.22	35.21	34.17	33.10	31.99	30.84	
50	59.93	59.09	58.25	57.39	56.52	55.63	54.74	53.82	52.89	51.95	50.98	50	49.00	47.97	46.93	45.86	44.77	43.64	42.49	41.31	40.09	
60	76.16	74.83	73.48	72.11	70.71	69.28	67.82	66.33	64.81	63.25	61.64	60	58.31	56.57	54.77	52.92	50.99	48.99	46.90	44.72	42.43	
63	78.16	76.91	75.63	74.33	73.01	71.67	70.30	68.90	67.47	66.02	64.53	63	61.44	59.83	58.18	56.49	54.74	52.93	51.06	49.12	47.10	

Multi-cables connection



Without accessory

Rating	Tightening torque	2 Copper cables		3 Multi-cables / Different wires	
		Rigid / Stranded	Flexible or ferrule	Flexible / Stranded	Flexible / Stranded / Rigid
		DB122945 	DB122946 	DB118787 	
≤ 25 A	2.5 N.m / 22 lb.in	2 x 1 mm ² to 2 x 10 mm ² 2 x 18 AWG - 2 x 8 AWG		3 x 1 mm ² 3 x 18 AWG	2 x 2.5 mm ² + 1 x 1.5 mm ² 2 x 13 AWG + 1 x 15 AWG
> 25 A	3.5 N.m / 31 lb.in	2 x 1 mm ² to 2 x 16 mm ² 2 x 18 AWG - 2 x 6 AWG		3 x 4 mm ² 3 x 6 AWG	2 x 10 mm ² + 1 x 6 mm ² 2 x 8 AWG + 1 x 9 AWG

C120N circuit breakers (curves B, C, D)

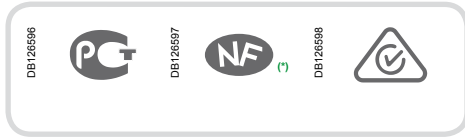

18360



18376

IEC/EN 60898-1, CEI 60947-2

C120N circuit breakers are multistandard circuit breakers that combine the following functions:

- Circuit protection against short-circuit currents,
- Circuit protection against overload currents,
- Suitability for isolation in the industrial sector to IEC/EN 60947-2,
- Fault tripping and indication by adding auxiliaries.

Alternating current (AC) 50/60 Hz

Breaking capacity (Icu) to IEC/EN 60947-2					Service breaking capacity (Ics)
Type	Voltage (V)				
1P	130 V	230 to 400 V	400 to 415 V	440 V	75 % Icu
Rating (In) 63 to 125 A	20 kA	10 kA	3 kA ⁽¹⁾	-	
2P/3P/4P	130 V	230 to 400 V	400 to 415 V	440 V	75 % Icu
63 to 125 A	-	20 kA	10 kA	6 kA	

Breaking capacity (Icu) to CEI/EN 60898-1

Type	Voltage (V)		Service breaking capacity (Ics)
1P, 2P, 3P, 4P	230 to 400 V		
Rating (In) 63 to 125 A	10000 A		



⁽¹⁾ One-pole breaking capacity in IT isolated neutral system (double fault).

Direct current (DC)

Breaking capacity (Icu) to IEC/EN 60947-2					Service breaking capacity (Ics)
Type	Voltage (V)				
1P	24/48 V	125 V	250 V		100 % Icu
Rating (In) 63 to 125 A	10 kA	10 kA	-		
2P (in series)	24/48 V	125 V	250 V		100 % Icu
63 to 125 A	-	-	10 kA		

Catalogue numbers

C120N circuit breaker

Type	1P			2P		
						
Auxiliaries	Remote indication and tripping, page 136			Remote indication and tripping, page 136		
Vigi C120	Vigi C120 add-on residual current device, page 89			Vigi C120 add-on residual current device, page 89		
Rating (In)	Curve			Curve		
	B	C	D	B	C	D
63 A	18340	18356	18378	18344	18360	18382
80 A	18341	18357	18379	18345	18361	18383
100 A	18342	18358	18380	18346	18362	18384
125 A	18343	18359	18381	18347	18363	18385
Largeur en pas de 9 mm	3			6		
Accessories	Page 136			Page 136		

^(*) NF B and C curves only.

C120N circuit breakers (curves B, C, D) (cont.)

■ Terminals insulated to IP20



■ Location for 4 clip-on terminal markers



Positive contact indication

- Suitability for isolation in the industrial sector to IEC/EN 60947-2.
- The presence of the green strip guarantees that the contacts open physically and allows work to be carried out safely on the downstream circuit.

■ Label holder on toggle



- Longer product service life thanks to:
 - good overvoltage withstand capacity: products designed to offer a high industrial performance level (degree of pollution, rated impulse withstand voltage and insulation voltage).
 - high limitation performances (see limitation curves).
 - fast closure independent of toggle operating speed.
- Remote indication of the open/closed/tripped state by auxiliary contacts (optional).
- Power supply from above or below.

3P				4P			
Remote indication and tripping, page 136				Remote indication and tripping, page 136			
Vigi C120 add-on residual current device, page 89				Vigi C120 add-on residual current device, page 89			
Curve				Curve			
B		C		B		C	
18348		18364		18352		18371	
18349		18365		18353		18372	
18350		18367		18354		18374	
18351		18369		18355		18376	
9				12			
Page 136				Page 136			

C120N circuit breakers (curves B, C, D) (cont.)

Connection

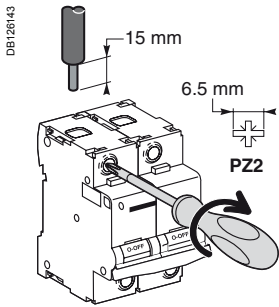

Rating	Tightening torque	Without access.		With accessories			
		Rigid/semi-rigid	Flexible or with ferrule	50 mm ² Al Terminal	Screw-on connection for ring terminal ⁽¹⁾	Rigid cables	Flexible cables
63 to 125 A	3.5 N.m	DB122945 1 to 50 mm ²	DB122946 1.5 to 35 mm ²	Al 16 to 50 mm ²	DB122935 DB118789 Ø 5 mm	DB118787 3 x 16 mm ²	3 x 10 mm ²

(1) For lugs up to 63 A, front or rear access.

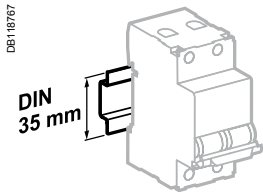

Clips onto 35 mm DIN rail.

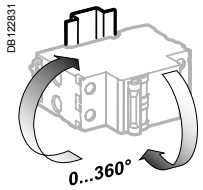

Any installation position.

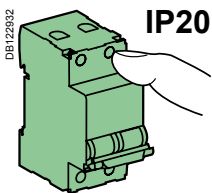

IP20

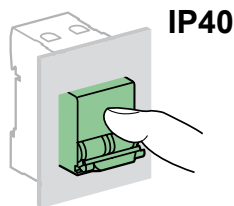

IP40

Technical data

Main characteristics

To IEC/EN 60947-2

Insulation voltage (U _i)	500 V AC
Degree of pollution	3
Rated impulse withstand voltage (U _{imp})	6 kV
Thermal tripping	Reference temperature 50 °C

To IEC/EN 60898-1

Magnetic tripping	Curve B	3 and 5 I _n
	Curve C	5 and 10 I _n
	Curve D	10 and 14 I _n
Limitation class		3

Additional characteristics

Degree of protection (IEC 60529)	Device only	IP20	
	Device in a modular enclosure	IP40	
Endurance (O-C)	Electrical	63 A	10000 cycles (O-C)
		80...125 A	5000 cycles (O-C)
	Mechanical		20000 cycles
Operating temperature		-25 °C to +70 °C	
Storage temperature		-40 °C to +85 °C	
Tropicalisation (IEC 60068-1)		Treatment 2 (relative humidity 95 % at 55 °C)	

C120N circuit breakers (curves B, C, D) (cont.)

Weight (g)

Circuit breaker	
Type	C120N
1P	205
2P	410
3P	615
4P	820

Dimensions (mm)

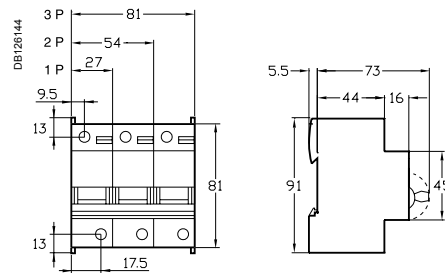

C120H circuit breakers (curves B, C, D)

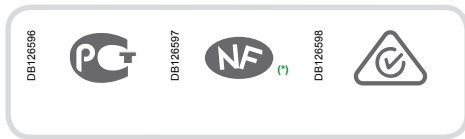

IEC/EN 60898-1, CEI 60947-2

C120H circuit breakers are multistandard circuit breakers that combine the following functions:

- circuit protection against short-circuit currents
- circuit protection against overload currents
- suitability for isolation in the industrial sector to IEC/EN 60947-2
- fault tripping and indication by adding auxiliaries.



18503



18437

Alternating current (AC) 50/60 Hz

Breaking capacity (Icu) to IEC/EN 60947-2					Service breaking capacity (Ics)
Type	Voltage (V)				
1P	130 V	230 to 240 V	400 to 415 V	440 V	50 % Icu
Rating (In) 10 to 125 A	30 kA	15 kA	4,5 kA ⁽¹⁾	-	
2P, 3P, 4P	130 V	230 to 240 V	400 to 415 V	440 V	50 % Icu
10 to 125 A	-	30 kA	15 kA	10 kA	

Breaking capacity (Icu) to CEI/EN 60898-1		
Type	Voltage (V)	
1P, 2P, 3P, 4P	230 to 400 V	
Rating (In) 10 to 125 A	15000 A	
	50 % Icu	

⁽¹⁾ One-pole breaking capacity in IT isolated neutral system (double fault).

Direct current (DC)

Breaking capacity (Icu) to IEC/EN 60947-2				Service breaking capacity (Ics)
Type	Voltage (V)			
1P	24/48 V	125 V	250 V	100 % Icu
Rating (In) 10 to 125 A	15 kA	15 kA	-	
2P (in series)	24/48 V	125 V	250 V	100 % Icu
10 to 125 A	-	-	15 kA	

Catalogue numbers

C120H circuit breaker

Type	1P	2P
Auxiliaries	Remote indication and tripping, page 136	Remote indication and tripping, page 136
Vigi C120	Vigi C120 add-on residual current device, page 89	Vigi C120 add-on residual current device, page 89
Rating (In)	Curve	Curve
	B	B
	C	C
	D	D
10 A	18394	18405
	18438	18449
	18482	18493
16 A	18395	18406
	18439	18450
	18483	18494
20 A	18396	18407
	18440	18451
	18484	18495
25 A	18397	18408
	18441	18452
	18485	18496
32 A	18398	18409
	18442	18453
	18486	18497
40 A	18399	18410
	18443	18454
	18487	18498
50 A	18400	18411
	18444	18455
	18488	18499
63 A	18401	18412
	18445	18456
	18489	18500
80 A	18402	18413
	18446	18457
	18490	18501
100 A	18403	18414
	18447	18458
	18491	18502
125 A	18404	18415
	18448	18459
	18492	18503
Width in 9 mm modules	3	6
Accessories	Page 136	Page 136

^(*) NF B and C curves only.

C120H circuit breakers (curves B, C, D)

■ Terminals insulated to IP20



■ Location for 4 clip-on terminal markers



■ Label holder on toggle



Positive contact indication

- Suitability for isolation in the industrial sector to IEC/EN 60947-2.
- The presence of the green strip guarantees that the contacts open physically and allows work to be carried out safely on the downstream circuit.

- Longer product service life thanks to:
 - good overvoltage withstand capacity: products designed to provide a high industrial performance level (degree of pollution, rated impulse withstand voltage and insulation voltage).
 - high limitation performances (see limitation curves).
 - fast closure independent of toggle operating speed.
- Remote indication of the open/closed/tripped state by auxiliary contacts (optional).
- Power supply from above or below.

3P



Remote indication and tripping, page 136

Vigi C120 add-on residual current device, page 89

Curve

B	C	D
18416	18460	18504
18417	18461	18505
18418	18462	18506
18419	18463	18507
18420	18464	18508
18421	18465	18509
18422	18466	18510
18423	18467	18511
18424	18468	18512
18425	18469	18513
18426	18470	18514

9

Page 136

4P

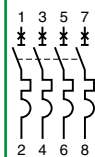

Remote indication and tripping, page 136

Vigi C120 add-on residual current device, page 89

Curve

B	C	D
18427	18471	18515
18428	18472	18516
18429	18473	18517
18430	18474	18518
18431	18475	18519
18432	18476	18520
18433	18477	18521
18434	18478	18522
18435	18479	18523
18436	18480	18524
18437	18481	18525

12

Page 136

C120H circuit breakers (curves B, C, D) (cont.)

Connection

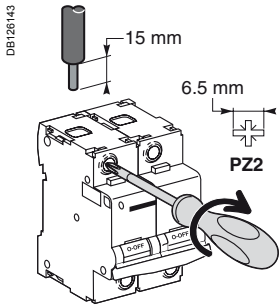

		Without access.		With accessories				
Rating	Tightening torque	Copper cables		50 mm ² Al term.	Screw-on connection for ring terminal ⁽¹⁾		Multi-cable terminal	
		Rigid	Flexible or with ferrule		Rigid cables	Flexible cables		
		DB1122945 	DB1122946 		DB1122935 	DB1118789 	DB1118787 	
10 to 125 A	3.5 N.m	1 to 50 mm ²	1.5 to 35 mm ²	16 to 50 mm ²	Ø 5 mm		3 x 16 mm ²	3 x 10 mm ²

(1) For lugs up to 63 A, front or rear accessories.

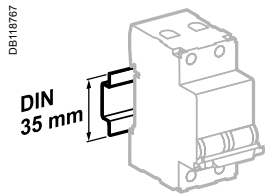

Clips onto 35 mm DIN rail.

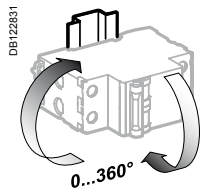

Any installation position.

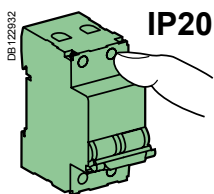

IP20

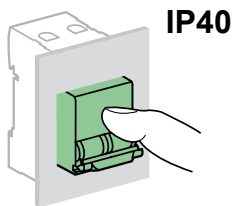

IP40

Technical data

Main characteristics			
To IEC/EN 60947-2			
Insulation voltage (U _i)		500 V AC	
Degree of pollution		3	
Rated impulse withstand voltage (U _{imp})		6 kV	
Thermal tripping	Reference temperature	50 °C	
To IEC/EN 60898-1			
Magnetic tripping	Curve B	3 and 5 In	
	Curve C	5 and 10 In	
	Curve D	10 and 14 In	
Limitation class		3	
Additional characteristics			
Degree of protection (IEC 60529)	Device only	IP20	
	Device in a modular enclosure	IP40 (IPXXD)	
Endurance (O-C)	Electrical	63 A	10000 cycles (O-C)
		80...125 A	5000 cycles (O-C)
	Mechanical	20000 cycles	
Operating temperature		-30 °C to +60 °C	
Storage temperature		-40 °C to +70 °C	
Tropicalisation (IEC 60068-1)		Treatment 2 (relative humidity 95% at 55°C)	

C120H circuit breakers (curves B, C, D) (cont.)

Weight (g)

Circuit breaker	
Type	C120H
1P	205
2P	410
3P	615
4P	820

Dimensions (mm)

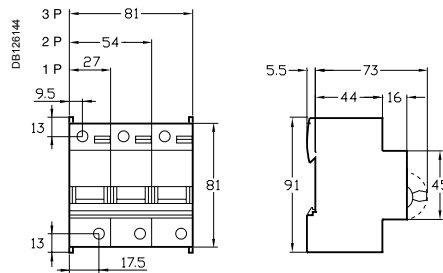



IEC/EN 60947-3

- The NG125NA is a switch-disconnector with free tripping for making and breaking under load.
- It is especially suitable for the modular enclosure incoming feeder with remote breaking (e.g. emergency cutoff) or earth leakage protection functions.

056909N_SE-30



NG125NA 3P

056909N_SE-30



NG125NA 4P

Catalogue numbers

NG125NA switch			
Type	3P		3P+N
Auxiliaries	Remote indication and tripping, module CM907005 – Vigi NG125 add-on residual current device, module CM902008		
Rating (In)	Quality label (1)		
63 A		18889	18897
80 A		18890	18898
100 A		18891	18899
125 A		18892	18900
Width in 9 mm modules		9	12
Accessories	Module CM907006		

(1) Information to be supplied by the country concerned.

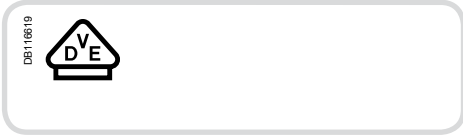

IEC/EN 60947-3

- The NG125NA is a switch-disconnector with free tripping for making and breaking under load.
- It is especially suitable for the modular enclosure incoming feeder with remote breaking (e.g. emergency cutoff) or earth leakage protection functions.



NG125NA 3P



NG125NA 4P

Catalogue numbers

NG125NA switch			
Type	3P		3P+N
Auxiliaries	Remote indication and tripping, module CM907005 – Vigi NG125 add-on residual current device, module CM902008		
Rating (In)	Quality label (1)		
63 A		18889	18893
80 A		18890	18894
100 A		18891	18895
125 A		18892	18896
Width in 9 mm modules		9	12
Accessories	Module CM907006		

(1) Information to be supplied by the country concerned.

Connection

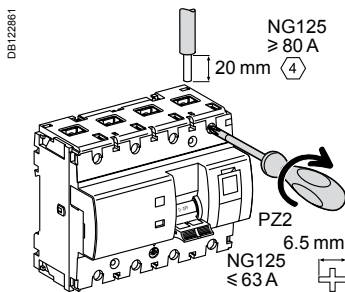

Rating	Tightening torque	Without accessories		With accessories				
		Copper cables		70 mm ² Al terminal	Screw-on connection for ring terminal	Small ring terminal	Multi-cable terminal	
		Rigid	Flexible or with ferrule				Rigid cables	Flexible cables
63 A	3.5 N.m	DB122945 1.5 to 50 mm ²	DB122946 1 to 35 mm ²	-	-	-	3 x 16 mm ²	3 x 10 mm ²
80 to 125 A	6 N.m	16 to 70 mm ²	10 to 50 mm ²	DB123488 25 to 70 mm ²	DB118789 2 x 35 mm ² 1 x 50 mm ²	DB118787 1 x 70 mm ²		

■ Upstream voltage taps for each pole, by 6.35 mm Fast-on terminal.

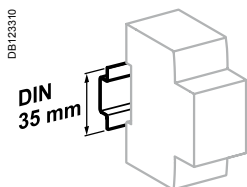

Clips onto 35 mm DIN rail.

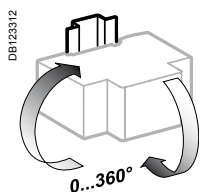

Any installation position.

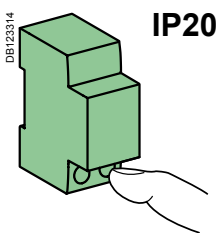

IP20

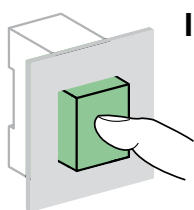

IP40

Technical data

Main characteristics			
According to IEC/EN 60947-3			
Max. voltage rating (Ue)	500 V AC		
Insulation voltage (Ui)	690 V AC		
Degree of pollution	3		
Rated impulse withstand voltage (Uimp)	8 kV		
Short time withstand current (50 ms) Icw	1.5 kA		
Utilization category	AC22A/B - AC23B		
Additional characteristics			
Degree of protection	Device only	IP20	
	Device in modular enclosure	IP40	
Endurance (O-C)		Category A	Category B
Electrical (except AC20 and DC20)	≤ 100 A	1500 cycles	300 cycles
	125 A	1000 cycles	200 cycles
Mechanical		20,000 cycles	
Operating temperature		-10°C to +60°C	
Storage temperature		-40°C to +70°C	
Tropicalization (IEC 60068-1)		Treatment 2 (relative humidity of 95% at 55°C)	

Weight (g)

Switch	
Type	NG125NA
3P	720
4P	960

Dimensions (mm)

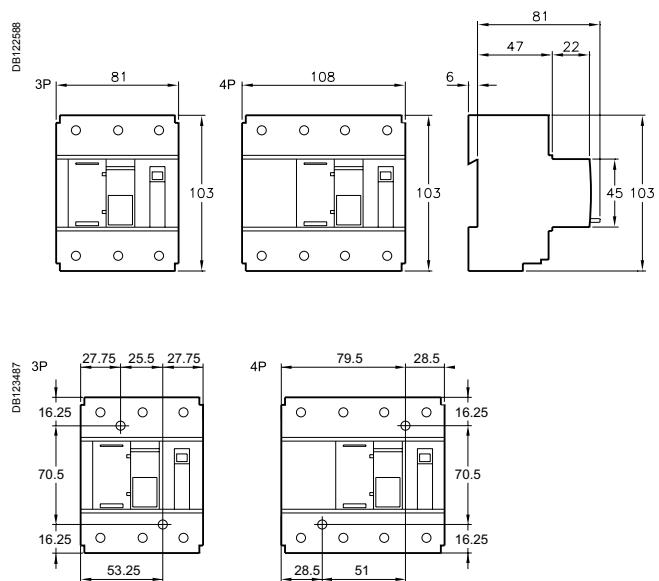

Spacing for mounting on panel

056918N_SE-90

- Cable strength:
 - ribbed cage
 - terminal depth
 - tightening by Allen hex key (NG125 ≥ 80 A)

- Voltage taps:
 - auxiliaries power supply
 - measurement
 - emergency stop
 - remote reporting

- Integrated padlocking device

- Test button to check satisfactory operation of the tripping mechanism



- Pull-out strength:
 - metallic lock



- Impact and vibration resistance:
 - high-strength enclosure
 - IK 05

- Circuit breaker tripped indicator

- Central manual control, 3 positions:
 - ON
 - tripped on fault
 - open

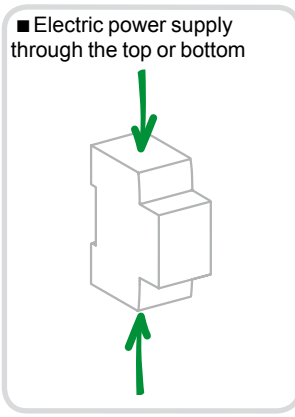

DB123483

- Positive contact indication:
 - suitability for isolation in the industrial sector to IEC/EN 60947-3;
 - the presence of the green strip guarantees that the contacts open physically and allows work to be carried out safely on the downstream circuit.

- Longer product service life due to:
 - good overvoltage withstand capacity;
 - high limitation performances;
 - fast closure independent of the speed of actuation of the toggle.





15646



15668

STI	Cartridges
IEC EN 60947-3	NF C 60-200, NF C 63-210 and IEC 60269-1/2

- The STI isolatable fuse-carriers provide overload and short-circuit protection.
 - They are used for industrial applications requiring a high breaking capacity.
 - They perform the isolation function and must not be used as switches.
 - They can be equipped with an indicator light indicating blowing of the fuse cartridge.
 - Isolation of all poles is guaranteed for the 2P, 3P, and 3P+N versions during factory assembly.
- The general purpose fuse (gG fuse) provides overload and short-circuit protection. The fuse for motor application (**aM fuse**) only provides short-circuit protection. It is used for protection of loads with a high peak current (motors, transformer primaries, etc.).

Accessories

Comb busbar

- Used to quickly bridge several STI of the same kind.

Busbar connectors

- Used to supply the busbar.
- For 25 mm² cable.

230 V neon indicator light

- Indicates fuse blowing (off in normal operation and lit red after fuse blowing).
- 400 V maxi.











Padlocking device

- Locks the toggle in the "open" or "closed" position. Used with an 8 mm max. diameter padlock (not supplied).

Clip-on markers (C60 type)

- Used to identify:
 - either on the front face of the device
 - or on the downstream terminals.

Catalogue numbers

Fuse cartridge						STI fuse holder					
Type	Rating	Voltage rating (Ue)	Short-circuit current (Isc)				Network type				
			aM	gG	aM	gG	1P	1P+N ⁽¹⁾	2P	3P	3P+N ⁽¹⁾
 8.5 x 31.5	2 A	400 V AC	20 kA	20 kA	15733	15767	 1 2	 N 1 2	 1 3 2 4	 1 3 5 2 4 6	 N 1 3 5 2 4 6
	4 A	400 V AC	20 kA	20 kA	15734	15768	2 modules of 9 mm	2 modules of 9 mm	4 modules of 9 mm	6 modules of 9 mm	6 modules of 9 mm
	6 A	400 V AC	20 kA	20 kA	15735	15769					
	10 A	400 V AC	20 kA	-	15737	-					
10.3 x 38	2 A	500 V AC	120 kA	120 kA	15742	15775	 1 2	 N 1 2	 1 3 2 4	 1 3 5 2 4 6	 N 1 3 5 2 4 6
	4 A	500 V AC	120 kA	120 kA	15743	15776	2 modules of 9 mm	2 modules of 9 mm	4 modules of 9 mm	6 modules of 9 mm	6 modules of 9 mm
	6 A	500 V AC	120 kA	120 kA	15744	15777					
	10 A	500 V AC	120 kA	120 kA	15746	15779					
	25 A	400 V AC	120 kA	-	15750	-					
	32 A	400 V AC	-	-	-	-					





Operating frequency : 50/60 Hz

(1) The neutral pole comes equipped with a locked tube.

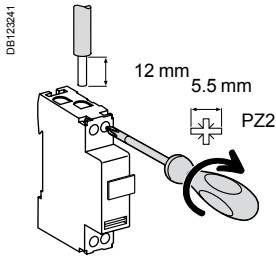
STI isolatable fuse-carriers (cont.)

Connection



Type	Rating	Tightening torque	Without accessory				With accessories
			Copper cables		Multi-cables terminal		Screw-on connection for ring terminal
			Rigid	Flexible or ferrule	Rigid cables	Flexible cables	
STI	All	2 N.m	<small>DBI123445</small>  0.75 to 10 mm ²	<small>DBI123446</small>  0.33 to 6 mm ²	<small>DBI118787</small>  0.75 to 10 mm ²	<small>DBI118789</small>  0.33 to 6 mm ²	 Ø 5 mm

2	Screw-on connection for ring terminal		27053
3	Insulated connectors (set of 4)		14885
4	Comb busbar 24 pas 1P		14881
	26 pas 1P+N		14880
	24 pas 2P		14882
	24 pas 3P		14883
	24 pas 4P		14884
5	Flange for comb busbars (set of 40)	For 1P, 2P	14886
		For 3P, 4P	14887
6	Teeth shield (set of 40)		14888

DBI123525

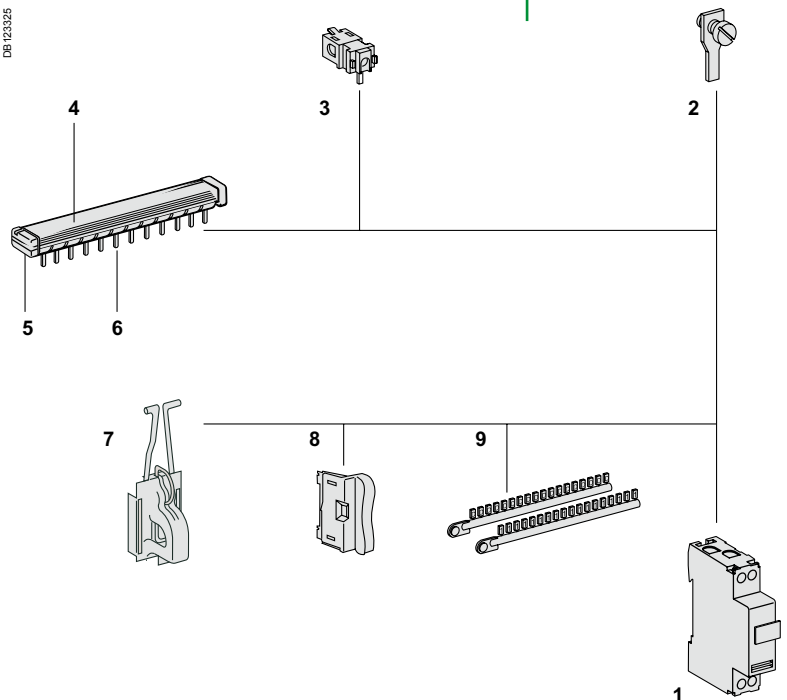

Mounting accessories

7	Padlocking device		15669
8	Neon indicator light	1 piece blister	15668
9	Clip-on terminal markers	See module	CA907001

STI isolatable fuse-carriers (cont.)

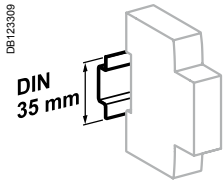

Clip on DIN rail 35 mm.

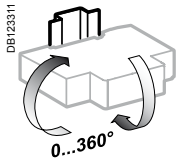

Indifferent position of installation.

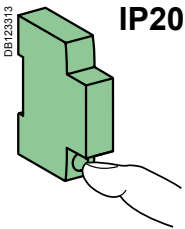

IP20

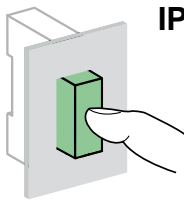

IP40

Technical data

Main characteristics

Insulation voltage (Ui)	690 V
Pollution degree	3

Additional characteristics

Degree of protection	Device only	IP20
	Device in modular enclosure	IP40
Operating temperature	Insulation classe II -20°C to +60°C	
Storage temperature	-40°C to +80°C	
Isolation with positive contact indication by tilting the fuse-carrier	Captive fuse-carrier Additional housing is provided for a spare fuse	
Cartridge blowing signalling (option)	By indicator light ON after blowing	

To be equipped with aM or gG (gL - gl) type fuse cartridge without striker, with or without fuse blowing indicator:

Fuse cartridge type		I _{th}	P _{max} *
8.5 x 31 mm	aM	10 A	3 W
	gG	20 A	3 W
10.3 x 38 mm	aM	25 A	3.5 W
	gG	32 A	3.5 W

*P_{max}: maximum dissipated power per fuse cartridge.

Specific technical data STI 1P+N and 3P+N

Disconnection of the phase and neutral in the normal dimensions of the phase (2 mod. of 9 mm)

Phase opening causes compulsory opening of the neutral

The phase opens before the neutral on isolation and closes after the neutral on circuit closing

Dimensions (mm)

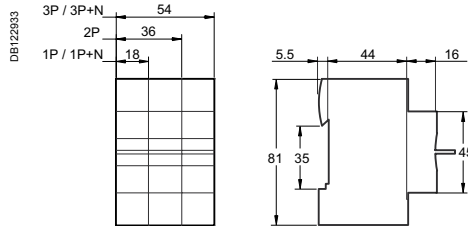

STI

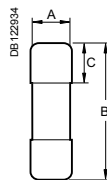

aM, gG fuse cartridge

Type	A	B	C
8.5 x 31.5 mm	8.5	31.5	10.3
10.3 x 38 mm	10.3	38	10.5

aM, gG





Choice of sensitivity

The sensitivity of an earth leakage protection device depends mainly on the function it has to perform:

- Protection from electric shock by direct contact.
- Protection from electric shock by indirect contact.
- Protection from fire due to current leakage.

The following table gives a reminder of:







- The circuits that must be protected against these various risks (obligation or recommendation).
- The type of earth leakage protection device to be used in each case, its sensitivity, and its location in the distribution diagram.

Type of protection	Obligations		Recommended by Schneider Electric	Sensitivity (I Δ n)		
	National standard <i>To be filled in according to the country standard</i>	International standard IEC 60364		30 mA (*)	100 mA to 3000 mA (depending on the earthing system)	300 mA (or 500 mA)
Protection from electric shock by direct contact 	<i>To be filled in according to the country standard</i>	Power supply for <ul style="list-style-type: none"> ■ General-purpose power sockets, up to 20 A ■ Appliances in the vicinity of a bathtub, shower, pond or swimming pool ■ Portable appliances for outdoor use, up to 32 A ■ Lighting for exhibition stands and shows ■ Outdoor lighting <i>To be modified according to national obligations (above)</i>	<ul style="list-style-type: none"> ■ Lighting in the home 	Setup in final distribution switchboard <ul style="list-style-type: none"> ■ Residual current device protecting a circuit ■ Residual current circuit breaker protecting a group of circuits 		
Protection from electric shock by indirect contact 	<i>To be filled in according to the country standard</i>	The entire power distribution system, except for devices: <ul style="list-style-type: none"> ■ With class II insulation ■ Operating at Safety Extra Low Voltage (class III) <i>To be modified according to national obligations (above)</i>	–	Setup in final distribution switchboard <ul style="list-style-type: none"> ■ Residual current circuit breaker or device, on incoming feeder Setup in subdistribution board or main switchboard <ul style="list-style-type: none"> ■ Residual current device protecting a circuit ■ Residual current device or circuit breaker protecting a group of circuits ■ On incoming feeder: residual current circuit breaker or device 		
Protection from fire due to current leakage 	<i>To be filled in according to the country standard</i>	<ul style="list-style-type: none"> ■ High-risk premises: <ul style="list-style-type: none"> □ explosion (BE3) □ fire (BE2) ■ Agricultural and horticultural buildings ■ Equipment for fairs, exhibitions and shows ■ Temporary outdoor recreational installations <i>To be modified according to national obligations (above)</i>	<ul style="list-style-type: none"> ■ Dilapidated buildings or electrical installations ■ Humid atmospheres: agricultural buildings, public swimming pools ■ Presence of chemical agents 		Setup in final distribution switchboard <ul style="list-style-type: none"> ■ Residual current circuit breaker or device, on incoming feeder Setup in subdistribution board or main switchboard <ul style="list-style-type: none"> ■ Residual current device protecting each circuit to a high-risk zone ■ Residual current device or circuit breaker protecting a group of circuits ■ On incoming feeder: residual current circuit breaker or device 	

(*) The 10 mA sensitivity is useful for certain very specific applications, where there is a risk that someone could sustain a non-dangerous current (10 to 30 mA) without being able to get free. Example: healthcare equipment for hospital beds. Generally, devices with this very high sensitivity are liable to cause frequent tripping, due to the natural leakage currents of the installation.

Interference immunity

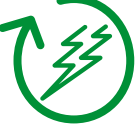

Schneider Electric provides various equipment technologies capable of overcoming the consequences of interference of all kinds.

Operating conditions		Examples	Types				
			AC	A	A si	B	
Loads						   	
	With no special characteristics	<ul style="list-style-type: none"> General-purpose power sockets Incandescent lighting Household appliances: microwave oven, dishwasher, clothes dryer Electric heating, water heater 	■	■	■	■	
	Including a rectifier	Single phase	<ul style="list-style-type: none"> Household appliances: induction cooking appliances, washing machines (variable speed) Single-phase variable speed drives 	-	■	■	-
		Three phase	<ul style="list-style-type: none"> Three-phase variable speed industrial drives Three-phase uninterruptible power supplies 	-	-	-	■
	Generating high-frequency interference (current peaks, harmonics)	<ul style="list-style-type: none"> Fluorescent lighting powered by extra low voltage transformer, by electronic ballast Variable luminosity lighting Powerful IT equipment Single-phase variable speed industrial drives Air conditioning Telecommunications equipment Capacitor banks 	-	-	■	■	
Including an anti-harmonic filter in the power supply	<ul style="list-style-type: none"> Microcomputer systems Computer peripherals (printers, scanners, etc.) 	-	-	■	■		
Electrical environment							
	Vicinity of equipment generating transient overvoltages	<ul style="list-style-type: none"> High-powered switching devices Reactive energy compensation banks 	-	-	■	■	
	Circuits powered by an uninterruptible power supply	<ul style="list-style-type: none"> Backed-up networks 	-	-	■	■	
	"Isolated neutral" (IT) earthing system	-	-	-	■	■	
	Major risk of lightning strokes	<ul style="list-style-type: none"> Buildings protected by a lightning protection system Mountainous or humid regions Regions with high keraunic level 	-	-	■	■	
Atmosphere							
	Ambient temperature which could be less than -5°C	-	-	■	■	■	
	Presence of corrosive agents (AF2 to AF4) or dust	<ul style="list-style-type: none"> Indoor swimming pools Yacht harbours, marinas, camping grounds Water treatment Chemical industries, heavy industries, paper mills Mines and cellars, road tunnels Markets, stock raising, food processing industries 	-	-	■ (1)	-	



(1) SiE for C120 and NG125 circuit-breakers

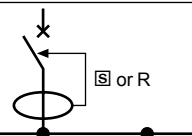
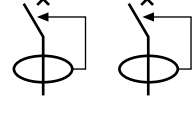

Discrimination

Residual current devices of average sensitivity (100 mA and more) are available in a selective (S) and delayed (R) version. This option ensures that, in the event of an earth fault downstream of the installation, only the defective part is switched off. The table below shows (in green) which upstream/downstream equipment combinations provide this discrimination.

Sensitivity (mA) - Downstream		Sensitivity (mA) - Upstream												
		Instantaneous						Selective S			Delayed R			
		30	100	300	500	1000	3000	100	300	500	1000	3000	1000	3000
	Instantaneous	30	-	-	-	-	-	-	-	-	-	-	-	-
		100	-	-	-	-	-	-	-	-	-	-	-	-
		300	-	-	-	-	-	-	-	-	-	-	-	-
		500	-	-	-	-	-	-	-	-	-	-	-	-
		1000	-	-	-	-	-	-	-	-	-	-	-	-
		3000	-	-	-	-	-	-	-	-	-	-	-	-
	Selective S	100	-	-	-	-	-	-	-	-	-	-	-	
		300	-	-	-	-	-	-	-	-	-	-	-	
		500	-	-	-	-	-	-	-	-	-	-	-	
		1000	-	-	-	-	-	-	-	-	-	-	-	
	Delayed R	1000	-	-	-	-	-	-	-	-	-	-	-	
		3000	-	-	-	-	-	-	-	-	-	-	-	

Selection guide

Type		Residual current circuit breakers			
		iID K	iID	RCCB-ID type B	
					
Standards		IEC/EN 61008	IEC/EN 61008	IEC/EN 61008 and VDE 0664	
Number of poles	1P+N	–	–	–	
	2P	■	■	–	
	3P	–	–	–	
	4P	–	■	■	
Type	AC	■	■	–	
	A	–	■	–	
	si(E)	–	■	–	
	B	–	–	■	
Voltage (V)	Ue	230/400	230/400	230/400	
Impulse voltage (kV)	Uimp	4	6	4	
Insulation voltage (V)	Ui	440	500	400	
Current rating (A)	In	25 - 40 - 63	16 to 100	25 to 125	
Frequency (Hz)		50/60	50/60	50	
Rated breaking capacity (A)	Icn	–	–	–	
Rated residual breaking and making capacity (A)	(IΔm)	10 In (500 A min.)	1500	10 In (500 A min.)	
Curve		–	–	–	
Sensitivity (mA)	(IΔn)	10	–	■	–
		30	■	■	■
		100	–	■	–
		300	■	■	■
		500	–	■	■
		1000	–	–	–
		3000	–	–	–
		300 \square	–	■	■
		500 \square	–	■	–
		1000 \square	–	–	–
		3000 \square	–	–	–
	Electrical characteristics				
Curves	B	–	–	–	
	C	–	–	–	
	D	–	–	–	
	L	–	–	–	
	K	–	–	–	
	MA	–	–	–	
	For more details, see page		Page 102	Page 97	Page 104
Accessories		–	Page 123 and 136	Page 104	

Add-on residual current devices	
PE101016_SE-35 	PB101466-40 
Vigi iC60	Vigi C120
IEC/EN 60947-2 and IEC/EN 61009	IEC/EN 60947-2 and IEC/EN 61009
-	-
■	■
■	■
■	■
■	■
■	■
■	■
-	-
130, 230/400	230/400
6	6
500	500
25 - 40 - 63	10 - 125
50/60	50/60
-	-
-	-
-	-
■	-
■	-
■	■
■	-
■	■
-	-
-	-
■	■
■	■
-	■
-	-
-	-
Depending on circuit breaker used	Depending on circuit breaker used
Page 82	Page 88
Page 123 and 136	Page 123 and 136



IEC/EN 61009-1



- Combined with iC60 circuit breaker, the Vigi iC60 provide:
 - protection of persons against electric shock by direct contact (≤ 30 mA),
 - protection of persons against electric shock by indirect contact (≥ 100 mA),
 - protection of installations against the risk of fire (300 mA or 500 mA).

Catalogue numbers

Vigi iC60 add-on residual current devices									
Type	AC						Width in 9 mm modules		
Product	Vigi iC60								
Auxiliaries	Without auxiliaries								
2P DB1122462	Sensitivity	30 mA	100 mA	300 mA	500 mA	300 mA			
		Rating	25 A	A9V41225 A9V01225*	A9V12225	A9V44225 A9V04225*	A9V16225	-	3
			40 A	A9V41240 A9V01240*	-	A9V44240 A9V04240*	A9V16240	-	4
			63 A	A9V41263 A9V01263*	A9V12263	A9V44263 A9V04263*	A9V16263	A9V15263	4
3P DB1122463	Sensitivity	30 mA	100 mA	300 mA	500 mA	300 mA			
		Rating	25 A	A9V41325	-	A9V44325	A9V16325	-	6
			40 A	A9V41340	-	A9V44340	A9V16340	-	7
			63 A	A9V41363	-	A9V44363	A9V16363	A9V15363	7
4P DB1122464	Sensitivity	30 mA	100 mA	300 mA	500 mA	300 mA			
		Rating	25 A	A9V41425	A9V12425	A9V44425	A9V16425	-	6
			40 A	A9V41440	-	A9V44440	A9V16440	-	7
			63 A	A9V41463	A9V12463	A9V44463	A9V16463	A9V15463	7
Voltage rating (Ue)		230 - 240 V, 400 - 415 V Except * 130 V							
Operating frequency		50/60 Hz							
Accessories		Page 123							



IEC/EN 61009-1



- Combined with iC60 circuit breaker, the Vigi iC60 provide:
 - protection of persons against electric shock by direct contact (≤ 30 mA),
 - protection of persons against electric shock by indirect contact (≥ 300 mA),
 - protection of installations against the risk of fire (300 mA).

The Asi type provides increased immunity from electrical interference and polluted or corrosive environments.

Catalogue numbers

Vigi iC60 add-on residual current devices					
Type	Asi				Width in 9 mm modules
Product	Vigi iC60				
Auxiliaries	Without auxiliaries				
2P	Sensitivity	10 mA	30 mA	300 mA 	
	Rating	25 A	A9V30225	A9V61225	-
		40 A	-	A9V61240	-
		63 A	-	A9V61263	A9V65263
3P	Sensitivity	10 mA	30 mA	300 mA 	
	Rating	25 A	-	A9V61325	-
		40 A	-	A9V61340	-
		63 A	-	A9V61363	A9V65363
4P	Sensitivity	10 mA	30 mA	300 mA 	
	Rating	25 A	-	A9V61425	-
		40 A	-	A9V61440	-
		63 A	-	A9V61463	A9V65463
Voltage rating (Ue)		230 - 240 V, 400 - 415 V			
Operating frequency		50/60 Hz			
Accessories		Page 123			

Connection

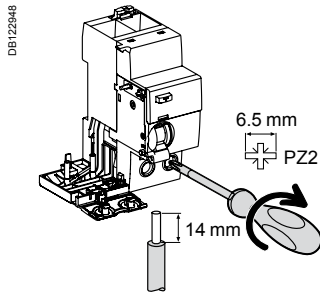

Type	Rating	Tightening torque	Copper cables	
			Rigid	Flexible or ferrule
Vigi iC60	25 A	2 N.m	1 to 25 mm ²	1 to 16 mm ²
	40 to 63 A	3.5 N.m	1 to 35 mm ²	1 to 25 mm ²

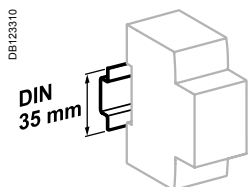

Clip on DIN rail 35 mm.

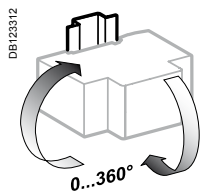

Indifferent position of installation.

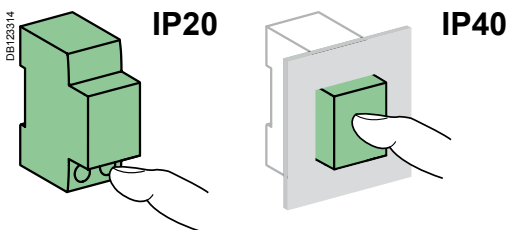

Technical data

Main characteristics

According to IEC 60947-2

Insulation voltage (U _i)	500 V
Pollution degree	3
Rated impulse withstand voltage (U _{imp})	6 kV

According to IEC/EN 61009-1

Surge current withstand (8/20 μs) without tripping	AC and A types (no selective \square)	250 Å
	AC, A types (selective \square)	3 kÅ
	Asi type	3 kÅ

Additional characteristics

Degree of protection	Device only	IP20
	Device in modular enclosure	IP40 Insulation classe II
Operating temperature	AC type	-5°C to +60°C
	A and Asi types	-25°C to +60°C
Storage temperature		-40°C to +85°C

Vigi iC60 add-on residual current devices (AC, A, Asi types) (cont.)

Weight (g)

Add-on residual current devices	
Type	Vigi iC60
2P	165
3P	210
4P	245

Dimensions (mm)

Vigi iC60 25 A

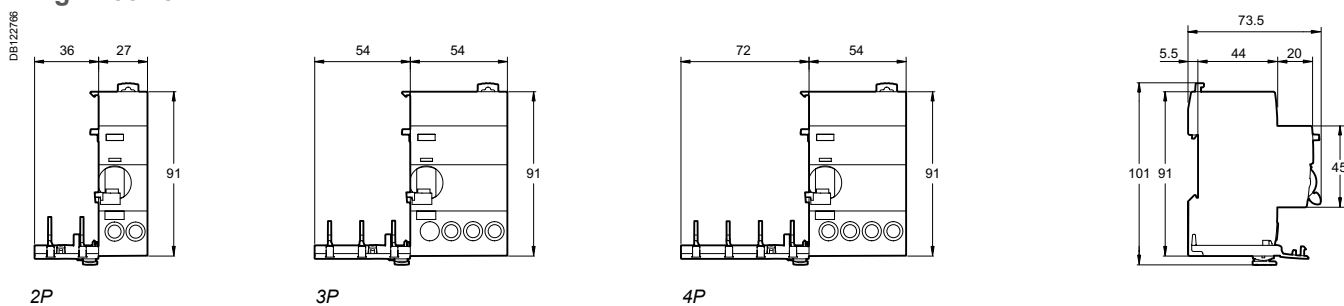

Vigi iC60 40 and 63 A

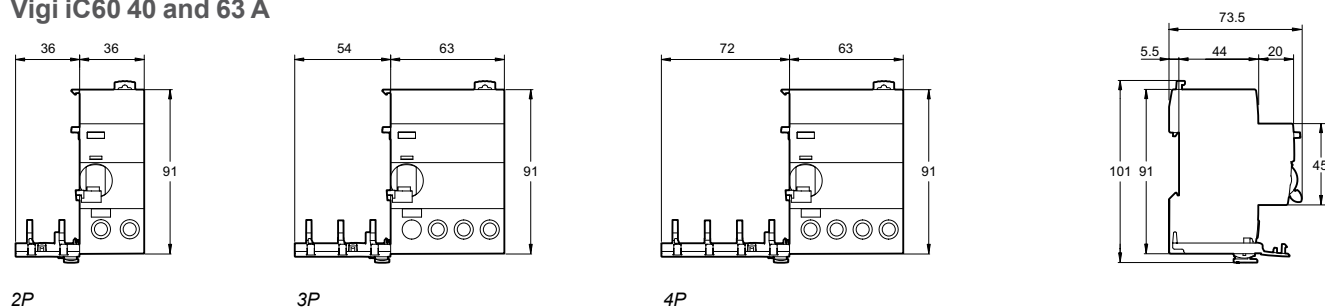

Vigi iC60 add-on residual current devices (AC, A, Asi types) (cont.)

DB123612



Association iC60a, N, H, L + Vigi iC60

iC60	Vigi iC60 25 A	Vigi iC60 40 A	Vigi iC60 63 A
0.5 A to 25 A	■	■	■
32 A - 40 A	NO	■	■
50 A - 63 A	NO	NO	■

Association iC60L-MA + Vigi iC60

iC60	Vigi iC60 25 A	Vigi iC60 40 A	Vigi iC60 63 A
1.6 A to 16 A	■	■	■
25 A - 40 A	NO	■	■

DB123515

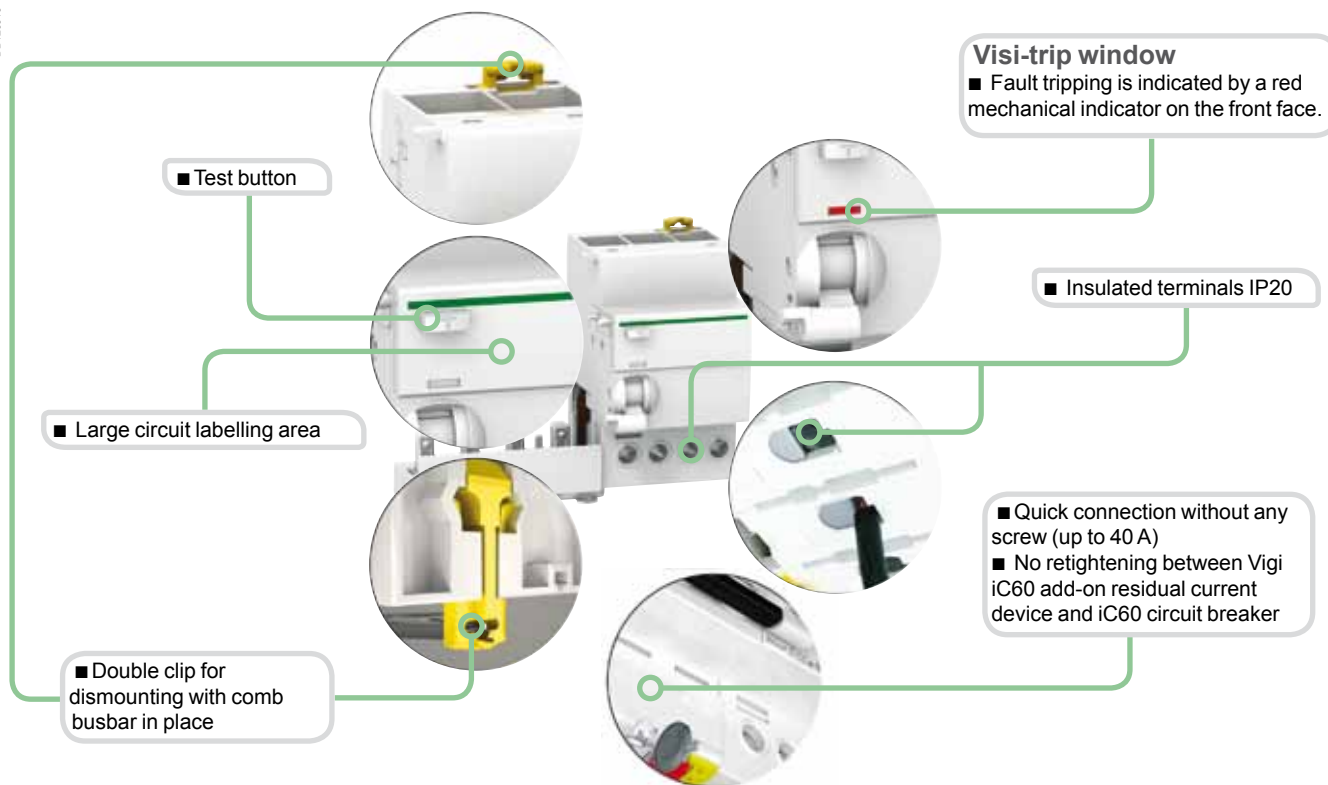

Asi type

The Asi type provides increased immunity from electrical interference and polluted or corrosive environments.



EN 61009

When a Vigi C120 device is combined with a C120 circuit breaker, it provides the following functions:

- protection of persons against electric shock by direct contact (30 mA),
- protection of persons against electric shock by indirect contact (≥ 300 mA),
- protection of installations against fire hazards (300 mA to 1000 mA).

086773_SE-44



2P

086774_SE-43



3P

086775_SE-55



4P

Catalogue numbers

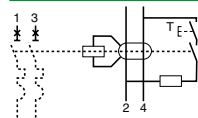
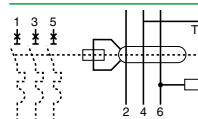
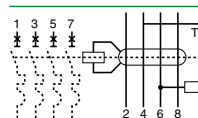
Vigi C120 add-on residual current devices						
Type	AC	Vigi C120				Width in 9 mm modules
Product		Without auxiliary				
Auxiliaries						
2P	Sensitivity	30 mA	300 mA	300 mA 	1000 mA 	
		18538	18539	18544	18545	7
3P	Sensitivity	30 mA	300 mA	300 mA 	1000 mA 	
		18540	18541	18546	18547	10
4P	Sensitivity	30 mA	300 mA	300 mA 	1000 mA 	
		18542	18543	18548	18549	10
Operating voltage (Ue)	230...415 V					
Operating frequency	50/60 Hz					
Accessories	Page 136					

Vigi C120 add-on residual current devices (type A)

EN 61009



When a Vigi C120 device is combined with a C120 circuit breaker, it provides the following functions :

- protection of persons against electric shock by direct contact (30 mA),
- protection of persons against electric shock by indirect contact (≥ 300 mA),
- protection of installations against fire hazards (300 mA to 1000 mA).



2P



3P



4P

Catalogue numbers

Vigi C120 add-on residual current devices								
Type	A Vigi C120							Width in 9 mm modules
Product	Without auxiliary							
Auxiliaries	Sensitivity							
	30 mA	300 mA	500 mA	300 mA	500 mA	1000 mA		
<p>dess. 077</p>	18572	18573	18574	18581	18582	18583		7
<p>dess. 079</p>	18575	18576	18577	18584	18585	18586		10
<p>dess. 078B</p>	18578	18579	18580	18587	18588	18559		10
Operating voltage (Ue)	230...415 V							
Operating frequency	50/60 Hz							
Accessories	Page 136							

Vigi C120 residual current devices (types A "si" and "SiE")

EN 61009

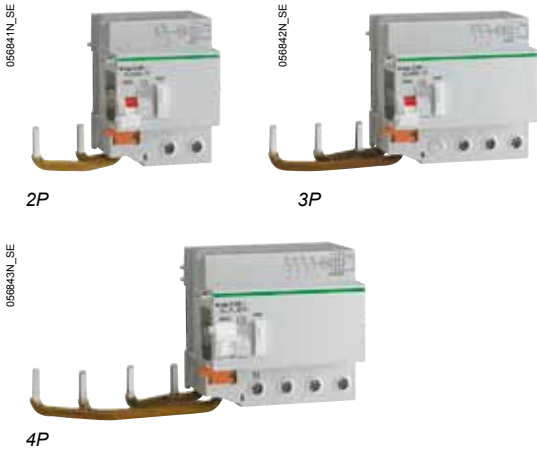

When a Vigi C120 device is combined with a C120 circuit breaker, it provides the following functions:

- protection of persons against electric shock by direct contact (30 mA),
- protection of persons against electric shock by indirect contact (≥ 300 mA),
- protection of installations against fire hazards (300 mA to 1000 mA).

Special feature of type A "si"

They are appropriate for operating in environments with:

- high risk of nuisance tripping: frequent lightning strikes, IT system, presence of electronic ballasts, frequency converters, presence of switchgear incorporating lighting type interference filters, computer system, etc.
- blind sources:
 - presence of harmonics or high frequency rejections
 - presence of DC components: diodes, diode bridges, switch-mode power supplies, etc.
- protected against nuisance tripping caused by transient voltage surges (lightning strike, operation of switchgear on the network, etc.)

Special feature of type A "SiE"

They are appropriate for operation in a humid atmosphere and/or an atmosphere polluted by aggressive agents: swimming pools, marinas, agro-food industry, water treatment plants, etc.

Catalogue numbers

Vigi C120 add-on residual current devices						
Type	"si"					Width in 9 mm modules
Product	Vigi C120					
Auxiliaries	Without auxiliary					
2P	Sensitivity	30 mA	300 mA	300 mA 	1000 mA 	
		18591	18592	18556	18557	7
3P	Sensitivity	30 mA	300 mA	300 mA 	1000 mA 	
		18594	18595	18558	18559	10
4P	Sensitivity	30 mA	300 mA	300 mA 	1000 mA 	
		18597	18598	18560	18561	10
Type	"SiE"					Width in 9 mm modules
Product	Vigi C120					
Auxiliaries	Without auxiliary					
3P	Sensitivity	30 mA	300 mA	300 mA 	1000 mA 	
		18676	18677	-	-	10
4P	Sensitivity	30 mA	300 mA	300 mA 	1000 mA 	
		18602	18678	18600	18601	10
Operating voltage (Ue)	230...415 V					
Operating frequency	50 Hz					
Accessories	Page 136					

EN 61009



When a Vigi C120 device is combined with a C120 circuit breaker, it provides the following functions:

- protection of persons against electric shock by direct contact (30 mA),
- protection of persons against electric shock by indirect contact (≥ 300 mA),
- protection of installations against fire hazards (300 mA to 1000 mA).



2P



3P



4P

Catalogue numbers

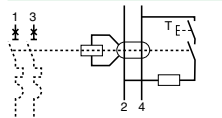
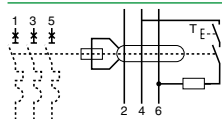
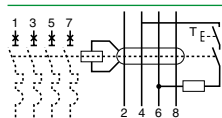
Vigi C120 add-on residual current devices							
Type	AC	Vigi C120					Width in 9 mm modules
Product	Without auxiliary						
Auxiliaries	Sensitivity						
2P		30 mA	300 mA	500 mA	300 mA	1000 mA	
		18563	18564	18565	18544	18545	7
3P		30 mA	300 mA	500 mA	300 mA	1000 mA	
		18566	18567	18568	18546	18547	10
4P		30 mA	300 mA	500 mA	300 mA	1000 mA	
		18569	18570	18571	18548	18549	10
Operating voltage (Ue)	230...415 V						
Operating frequency	50/60 Hz						
Accessories	Page 136						



EN 61009

When a Vigi C120 device is combined with a C120 circuit breaker, it provides the following functions :

- protection of persons against electric shock by direct contact (30 mA),
- protection of persons against electric shock by indirect contact (≥ 300 mA),
- protection of installations against fire hazards (300 mA to 1000 mA).

086773_SE-44



2P

086774_SE-43



3P

086775_SE-95



4P

Catalogue numbers

Vigi C120 add-on residual current devices								
Type	A Vigi C120							Width in 9 mm modules
Product	Without auxiliary							
Auxiliaries	Sensitivity	30 mA	300 mA	500 mA	300 mA	500 mA	1000 mA	
<div style="display: flex; align-items: center;"> <div style="writing-mode: vertical-rl; transform: rotate(180deg); font-size: 8px; margin-right: 5px;">dess. 077</div> </div>		18572	18573	18574	18581	18582	18583	7
<div style="display: flex; align-items: center;"> <div style="writing-mode: vertical-rl; transform: rotate(180deg); font-size: 8px; margin-right: 5px;">dess. 079</div> </div>		18575	18576	18577	18584	18585	18586	10
<div style="display: flex; align-items: center;"> <div style="writing-mode: vertical-rl; transform: rotate(180deg); font-size: 8px; margin-right: 5px;">dess. 078B</div> </div>		18578	18579	18580	18587	18588	18589	10
Operating voltage (Ue)	230...415 V							
Operating frequency	50/60 Hz							
Accessories	Page 136							

Vigi C120 residual current devices (types A "si" and "SiE")

EN 61009

When a Vigi C120 device is combined with a C120 circuit breaker, it provides the following functions:

- protection of persons against electric shock by direct contact (30 mA),
- protection of persons against electric shock by indirect contact (≥ 300 mA),
- protection of installations against fire hazards (300 mA to 1000 mA).

Special feature of type A "si" :

They are appropriate for operating in environments with:

- high risk of nuisance tripping: frequent lightning strikes, IT system, presence of electronic ballasts, frequency converters, presence of switchgear incorporating lighting type interference filters, computer system, etc.

- blind sources:

- presence of harmonics or high frequency rejections
- presence of DC components: diodes, diode bridges, switch-mode power supplies, etc.







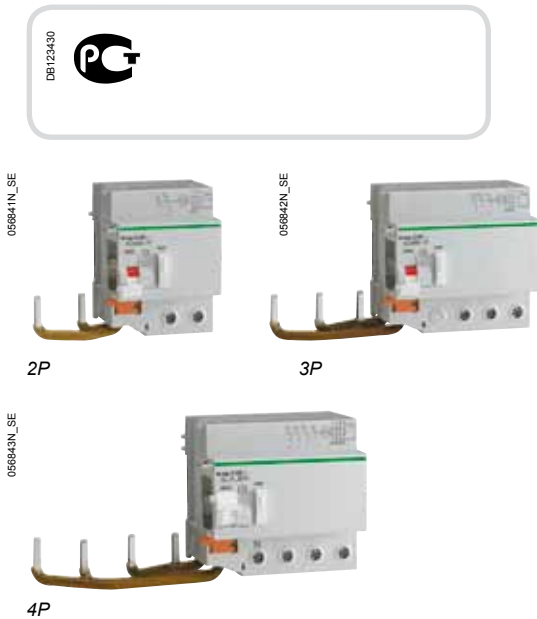



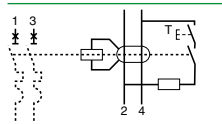

- protected against nuisance tripping caused by transient voltage surges (lightning strike, operation of switchgear on the network, etc.)

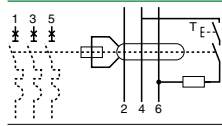
Special feature of type A "SiE" :

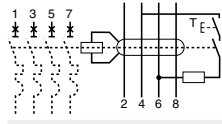
They are appropriate for operation in a humid atmosphere and/or an atmosphere polluted by aggressive agents: swimming pools, marinas, agro-food industry, water treatment plants, etc.

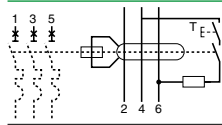

Catalogue numbers

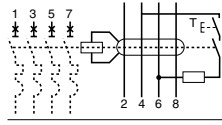
Vigi C120 add-on residual current devices							
Type	"si" 						Width in 9 mm modules
Product	Vigi C120						
Auxiliaries	Without auxiliary						
2P	Sensitivity	30 mA	300 mA	500 mA	300 mA 	1000 mA 	
		18591	18592	18593	18556	18557	7
3P	Sensitivity	30 mA	300 mA	500 mA	300 mA 	1000 mA 	
		18594	18595	18596	18558	18559	10
4P	Sensitivity	30 mA	300 mA	500 mA	300 mA 	1000 mA 	
		18597	18598	18599	18560	18561	10
Type	"SiE" 						Width in 9 mm modules
Product	Vigi C120						
Auxiliaries	Without auxiliary						
3P	Sensitivity	30 mA	300 mA	500 mA	300 mA 	1000 mA 	
		18676	18677	-	-	-	10
4P	Sensitivity	30 mA	300 mA	500 mA	300 mA 	1000 mA 	
		18602	18678	-	18600	18601	10
Operating voltage (Ue)	230...415 V						
Operating frequency	50 Hz						
Accessories	Page 136						

Vigi C120 residual current devices (types AC, A, "si" and "SiE")

Connection

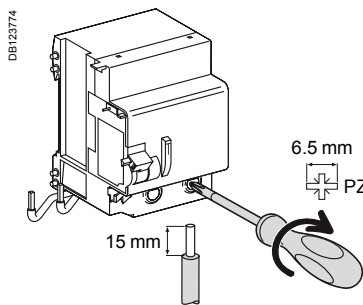

Type	Sensitivity	Tightening torque	Copper cables	
			Rigid	Flexible or with ferrule
Vigi C120	30...1000 mA	3.5 N.m	1 to 50 mm ²	1 to 35 mm ²

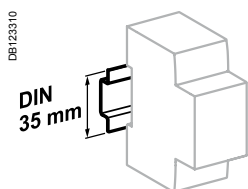

Clips onto 35 mm DIN rail.

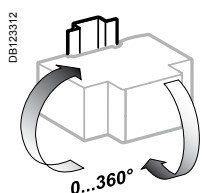

Any installation position.

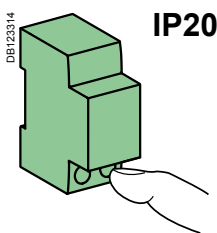

IP20

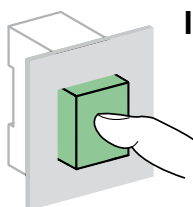

IP40

Caractéristiques techniques

Main characteristics

To IEC 60947-2

Insulation voltage (U _i)	500 V AC
Degree of pollution	3
Rated impulse withstand voltage (U _{imp})	6 kV

To EN 61009

Impulse current withstand (8/20 μs) without tripping	Types AC and A (non-selective ☒)	250 Å
	Types AC and A (selective ☒)	3 kÅ
	Types "si" and "SiE" (non-selective ☒)	3 kÅ
	Types "si" and "SiE" (selective ☒)	5 kÅ

Additional characteristics

Degree of protection	Device only	IP20
	Device in a modular enclosure	IP40
Operating temperature	Type AC	-5 °C to +60 °C
	Types A, "si" and "SiE"	-25 °C to +60 °C
Storage temperature		-40 °C to +85 °C

Weight (g)

Add-on residual current devices

Type	Vigi C120
2P	325
3P	500
4P	580

Dimensions (mm)

C120 + Vigi C120

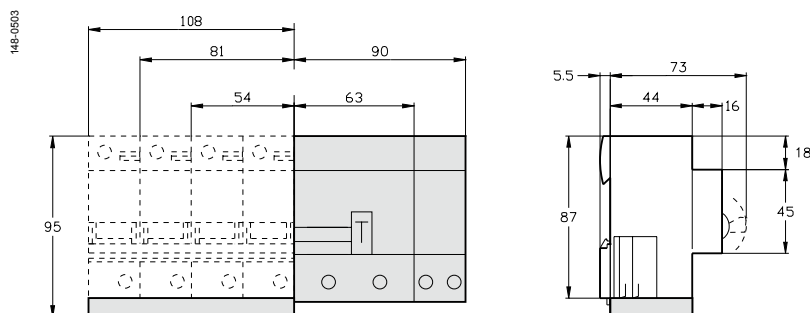

Vigi C120 residual current devices (types AC, A, "si" and "SiE") (cont.)

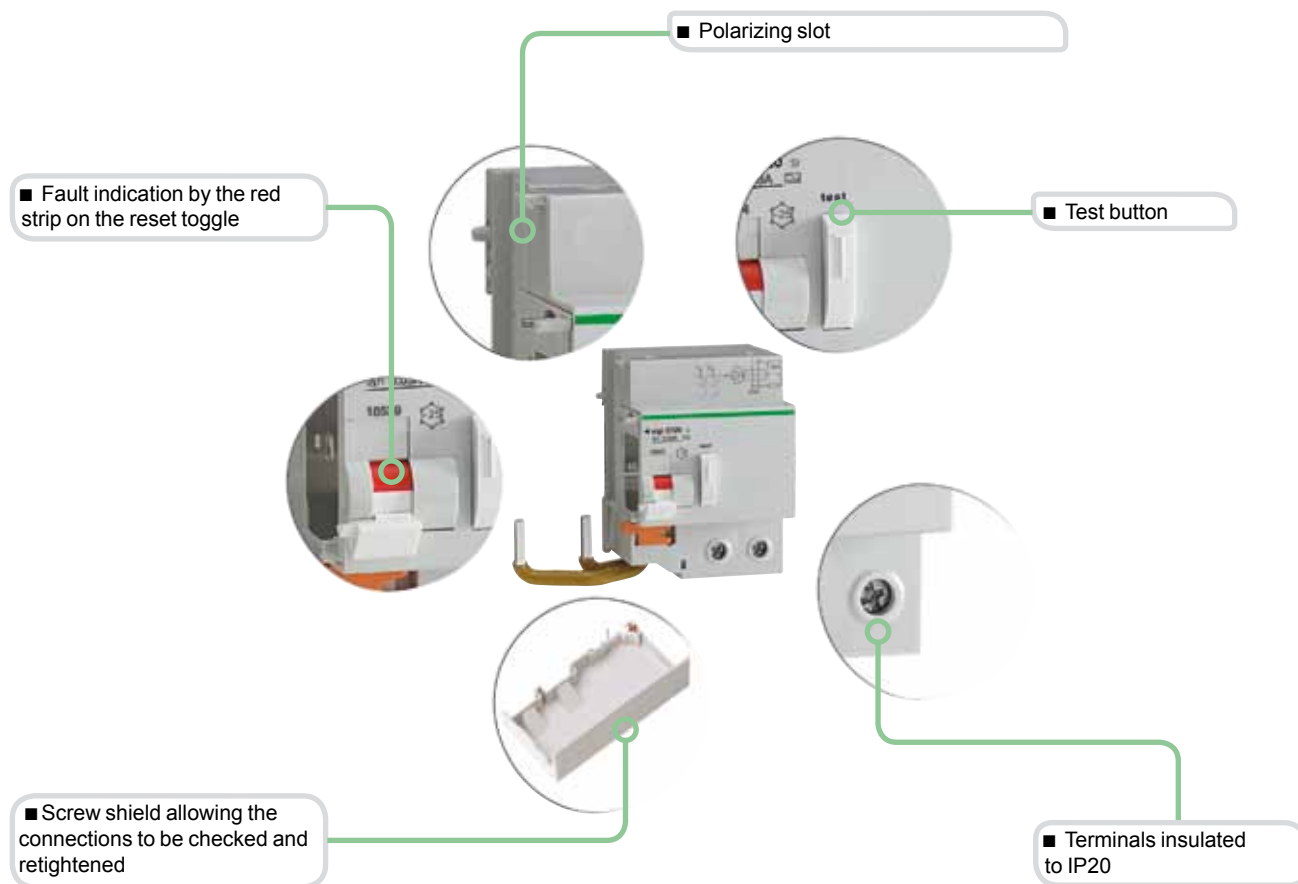

Type Asi

The Asi type provides increased immunity from electrical interference and polluted or corrosive environments.

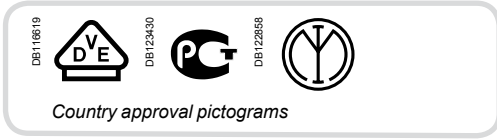

IEC/EN 61008-1



- The iID residual current circuit breakers provide:
 - protection of persons against electric shock by direct contact (≤ 30 mA),
 - protection of persons against electric shock by indirect contact (≥ 100 mA),
 - protection of installations against the risk of fire (300 mA or 500 mA).

Catalogue numbers

iID residual current circuit breakers									
Type	AC							Width in 9 mm module	
Product	iID								
Auxiliaries	Can accept auxiliaries, page 168								
	Sensitivity	30 mA	100 mA	300 mA	500 mA	300 mA	500 mA		
2P 	Rating	16 A	-	-	-	-	-	4	
		25 A	A9R41225	-	A9R44225	A9R16225	-		
		40 A	A9R41240	A9R12240	A9R44240	A9R16240	-		
		63 A	A9R41263	A9R12263	A9R44263	A9R16263	A9R15263		
		80 A	A9R11280	A9R12280	A9R14280	-	A9R15280		
		100 A	A9R11291	A9R12291	A9R14291	-	A9R15291		
4P 	Rating	25 A	A9R41425	-	A9R44425	A9R16425	-	8	
		40 A	A9R41440	A9R12440	A9R44440	A9R16440	A9R15440		A9R17440
		63 A	A9R41463	A9R12463	A9R44463	A9R16463	A9R15463		A9R17463
		80 A	A9R11480	A9R12480	A9R14480	A9R16480	A9R15480		A9R17480
		100 A	A9R11491	A9R12491	A9R14491	-	A9R15491		-
Voltage rating (Ue)	2P	230 - 240 V							
	4P	400 - 415 V							
Operating frequency	50/60 Hz								
Accessories	Pages 123 and 136								

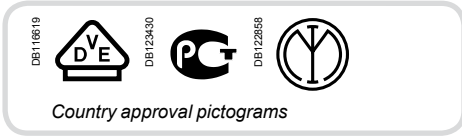

IEC/EN 61008-1



- The iID residual current circuit breakers provide:
 - protection of persons against electric shock by direct contact (≤ 30 mA),
 - protection of persons against electric shock by indirect contact (≥ 300 mA),
 - protection of installations against the risk of fire (300 mA or 500 mA).

The Asi type provides increased immunity from electrical interference and polluted or corrosive environments.

Catalogue numbers

iID residual current circuit breakers							
Type	Asi						Width in 9 mm module
Product	iID						
Auxiliaries	Can accept auxiliaries, page 168						
	Sensitivity	10 mA	30 mA	300 mA	300 mA	500 mA	
DB122476 	Rating 16 A 25 A 40 A 63 A 100 A	-	-	-	-	-	4
		A9R30225	A9R61225	-	-	-	
		-	A9R61240	-	A9R35240	-	
		-	A9R61263	-	A9R35263	-	
		-	-	-	A9R35291	-	
DB122477 	Rating 25 A 40 A 63 A 80 A 100 A	-	A9R61425	-	-	-	8
		-	A9R61440	-	A9R35440	A9R37440	
		-	A9R61463	A9R34463	A9R35463	A9R37463	
		-	A9R31480	-	A9R35480	A9R37480	
		-	A9R31491	A9R34491	A9R35491	-	
Voltage rating (Ue)	2P	230 - 240 V					
	4P	400 - 415 V					
Operating frequency	50/60 Hz						
Accessories	Pages 123 and 136						

iID residual current circuit breakers (AC, Asi types)

Connection

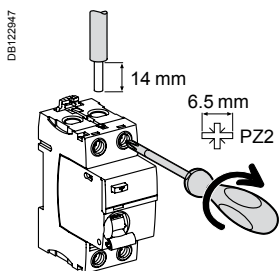

Type	Tightening torque	Without accessory		With accessories*			
		Copper cables		50 mm ² Al terminal	Screw-on connection for ring terminal	Multi-cables terminal	
		Rigid	Flexible or ferrule			Rigid cables	Flexible cables
iID	3.5 N.m	1 to 35 mm ²	1 to 25 mm ²	50 mm ²	Ø 5 mm	3 x 16 mm ²	3 x 10 mm ²

* See module CA907000

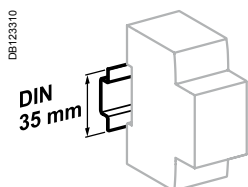

Clip on DIN rail 35 mm.

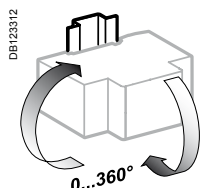

Indifferent position of installation.

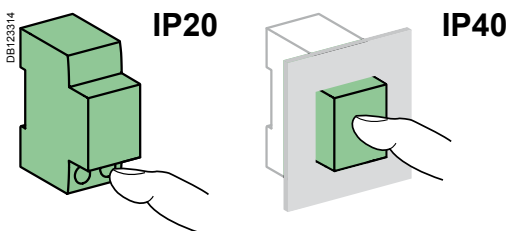

Technical data

Main characteristics			
According to IEC 60947			
Insulation voltage (U _i)		500 V	
Pollution degree		3	
Rated impulse withstand voltage (U _{imp})		6 kV	
According to IEC/EN 61008-1			
Making and breaking capacity (I _m /I _{dm})		1500 A	
Surge current withstand (8/20 µs) without tripping	AC (no selective \square)	250 Å	
	AC (selective \square)	3 kÅ	
	Asi type	3 kÅ	
Conditional rated short circuit current (I _{nc} /I _{dc})	With iC60N/H/L	Equal to breaking capacity of iC60	
	With fuse	10,000 A	
Additional characteristics			
Degree of protection	Device only	IP20	
	Device in modular enclosure	IP40 Insulation class II	
Endurance (O-C)	Electrical (AC1)	16 to 63 A	15,000 cycles
		80 to 100 A	10,000 cycles
	Mechanical		20,000 cycles
Operating temperature	AC type		-5°C to +60°C
	Asi types		-25°C to +60°C
Storage temperature			-40°C to +85°C

iID residual current circuit breakers (AC, Asi types) (cont.)

Weight (g)

Residual current circuit breakers	
Type	iID
2P	210
4P	370

Dimensions (mm)

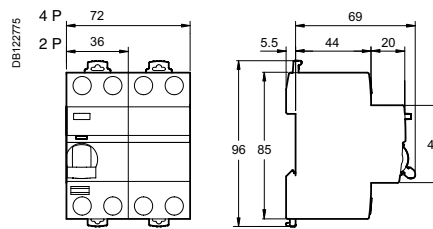

iID residual current circuit breakers (AC, Asi types) (cont.)

PB104548-40



PB104472-40

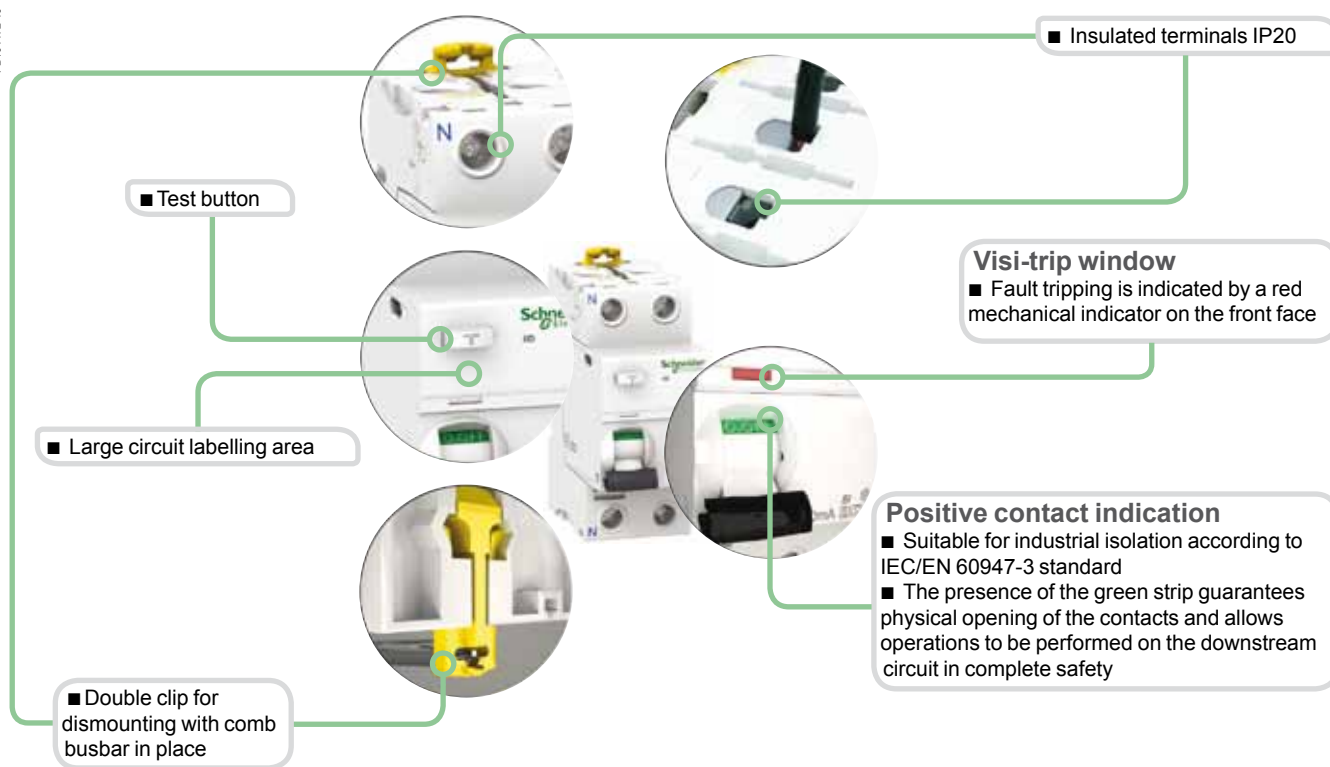

Asi type

The Asi type provides increased immunity from electrical interference and polluted or corrosive environments.



IEC/EN 61008-1

- The iID K residual current circuit breakers provide:
 - protection of persons against electric shock by direct contact (30 mA),
 - protection of persons against electric shock by indirect contact (300 mA)
 - protection of installations against the risk of fire (300 mA).



Catalogue numbers

iID K residual current circuit breakers					
Type	AC		Width in 9-mm modules		
Product	iID K				
Auxiliaries	Without auxiliaries				
2P	Sensitivity	30 mA	300 mA		
	Rating	25 A	A9R50225	A9R75225	4
		40 A	A9R50240	A9R75240	
Voltage rating (Ue)	2P	230 - 240 V			
Operating frequency			50/60 Hz		

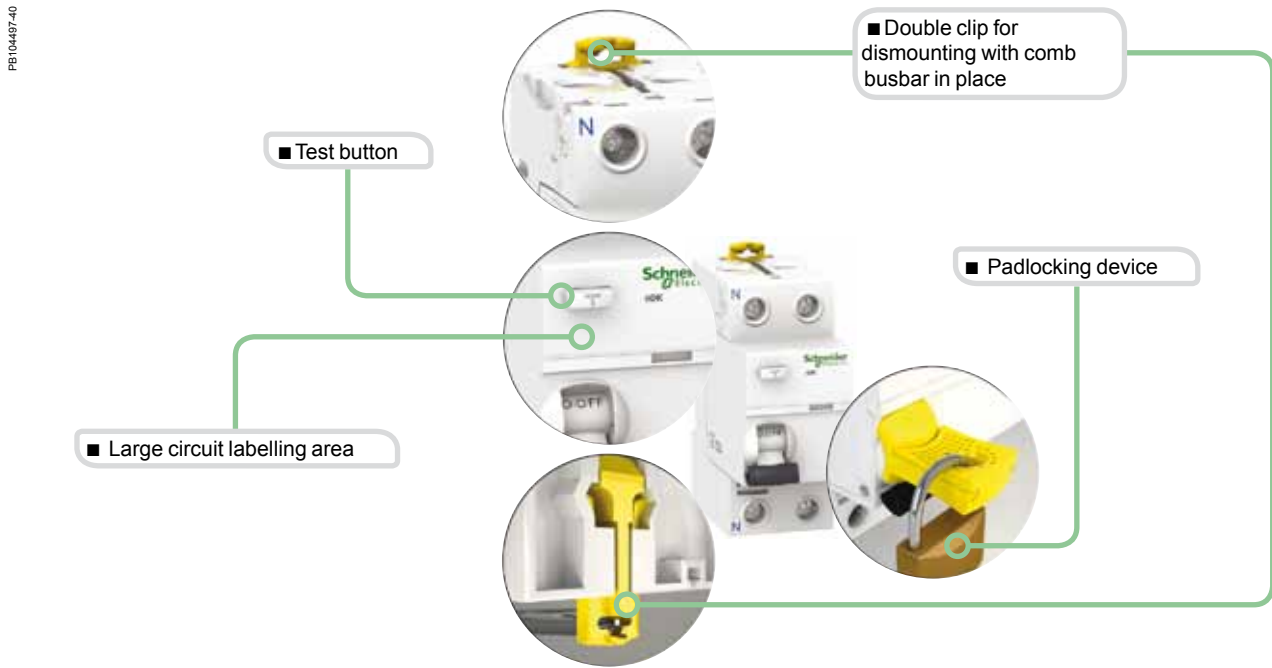

iID K residual current circuit breakers (cont.)

Connection

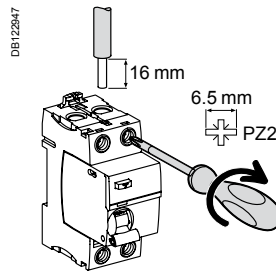

Type	Tightening torque	Without accessory	
		Copper cables	
		Rigid	Flexible or ferrule
iID K	3.5 N.m	1 to 35 mm ²	1 to 25 mm ²

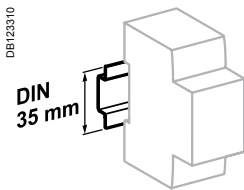

Clip on DIN rail 35 mm.

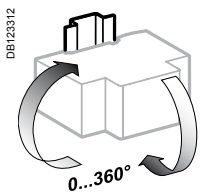

Indifferent position of installation.

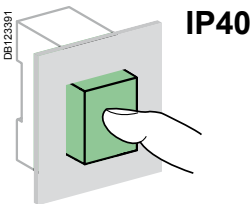

Technical data

Main characteristics		
According to IEC/EN 61008-1		
Insulation voltage (U _i)		440 V
Pollution degree		2
Rated impulse withstand voltage (U _{imp})		4 kV
Making and breaking capacity (I _m /I _{Dm})	25 to 40 A	500 A
	63 A	630 A
Surge current withstand (8/20 μs) without tripping		Up to 200 A
Conditional rated short circuit current (I _{nc} /I _{Dc})	With iC60N/H/L, iK60N	6000 A
	With fuse	4500 A
Additional characteristics		
Degree of protection	Device in modular enclosure	IP40
Endurance (O-C)	Electrical	2000 cycles (AC1)
	Mechanical	5000 cycles
Operating temperature		-5°C to +60°C
Storage temperature		-40°C to +85°C

Weight (g)

Residual current circuit breakers	
Type	iID K
2P	210

Dimensions (mm)

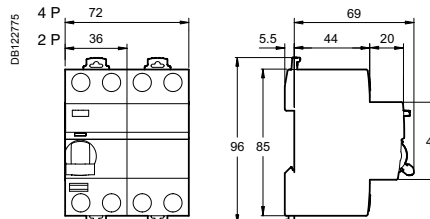

RCCB-ID 125 A residual current circuit breaker (AC, A, Asi types)

IEC/EN 61008-1, VDE 0664

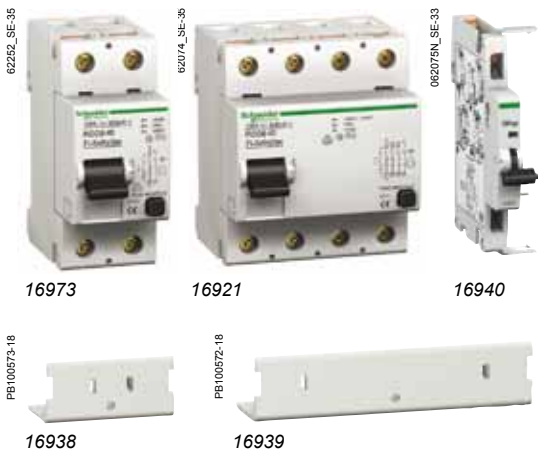

- The RCCB-ID 125 A residual current circuit breakers provide:
 - protection of persons against electric shock by direct contact (30 mA),
 - protection of persons against electric shock by indirect contact (≥ 100 mA),
 - protection of installations against the risk of fire (300 mA or 500 mA).

The Asi type provides increased immunity from electrical interference and polluted or corrosive environments.

OFsp auxiliary

- Electrical indication: by OFsp auxiliary mounted to the left, it has a double changeover switch indicating the "open" or "closed" position of the RCCB-ID 125 A.

Accessories

- 2P and 4P sealable screw shield.

Catalogue numbers

RCCB-ID 125 A residual current circuit breakers													
Type		AC				A				Asi		Width in 9 mm module	
2P	Sensitivity	30 mA	100 mA	300 mA	500 mA	30 mA	300 mA	300 mA	500 mA	30 mA	300 mA		
	Rating	125 A	16966	-	16967	-	16970	16971	-	-	16972	16973	4
4P	Sensitivity	30 mA	100 mA	300 mA	500 mA	30 mA	300 mA		500 mA	30 mA	300 mA		
	Rating	125 A	16905	16906	16907	16908	16924	16926	16925	16927	16920	16921	8
Voltage rating (Ue)		2P	230 V										
		4P	400 V										
Operating frequency		50 Hz											

Auxiliary				
Type				Width in 9 mm module
Contact OFsp	Contact	Voltage		
	1 A	110 V DC		16940
	6 A	230 V AC (AC15)		

Accessory		
Type	Number of pole	
Screw shield (set of 10) for upstream or downstream	2P	16938
	4P	16939

RCCB-ID 125 A residual current circuit breaker (AC, A, Asi types) (cont.)

Connection

■ By tunnel terminals for:

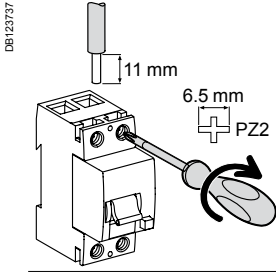

Type	Tightening torque	Copper cables	
		Rigid	Flexible or ferrule
RCCB-ID	3 N.m	1 x 1.5 to 50 mm ² 2 x 1.5 to 16 mm ²	1 x 1.5 to 35 mm ² 2 x 1.5 to 16 mm ²
OFsp	0.8 N.m	1 to 1.5 mm ²	1 to 1.5 mm ²

Technical data

OFsp contact status, depending on the position of the residual current circuit breaker

Type				
RCCB-ID 125 A	Closed	■	-	-
	Open	-	■	-
	Tripped on fault	-	-	■
Contact OFsp	22/21	Open	Closed	Closed
	12/11			
	14/11	Closed	Open	Open

Electrical characteristics

According to IEC 60947

Insulation voltage (U _i)	400 V
Pollution degree	3
Rated impulse withstand voltage (U _{imp})	4 kV

According to IEC/EN 61008-1

Making and breaking capacity (I _m /I _{Dm})	1250 A	
Surge current withstand (8/20 μs) without tripping	AC and A types (no selective ☒)	250 Å
	Asi type (no selective ☒)	3 kÅ
	AC, A and Asi types (selective ☒)	3 kÅ
Conditional rated short circuit current (I _{nc} /I _{Dc})	With FU 125 A gG fuse	10,000 A

Additional characteristics

Degree of protection	Device only	IP20 IP40 with screw shield
	Device in modular enclosure	IP40 Insulation classe II
Endurance (O-C)	Electrical	> 2 000 cycles
	Mechanical	> 5 000 cycles
Operating temperature		-25°C to +40°C
Storage temperature		-40°C to +85°C



Indication of the status of the RCCB-ID via the 3-position toggle and front panel indicator

- Closed (red indicator)
- Tripped on fault (green indicator)
- Open (green indicator)

Weight (g)

Residual current circuit breakers and auxiliary

Type	RCCB-ID 125 A	OFsp
2P	230	40
4P	420	

Dimensions (mm)

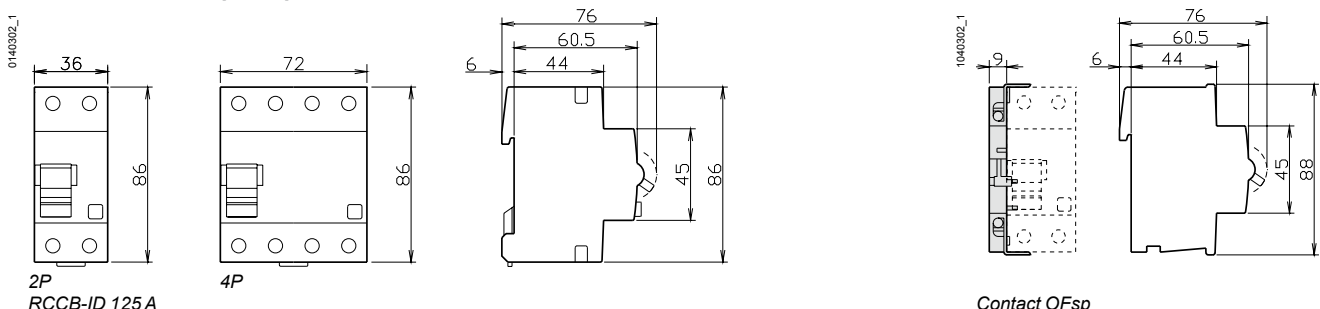

IEC/EN 61008, VDE 0664



16766



16940



16939

- The RCCB-ID 125 A residual current circuit breakers provide:
 - protection of persons against electric shock by direct contact (30 mA),
 - protection of persons against electric shock by indirect contact (≥ 300 mA),
 - protection of installations against the risk of fire (300 mA or 500 mA).

B type

The RCCB-ID B type residual current circuit breakers provide:

- protection in the event of a continuous fault current on three-phase networks generated by:
 - controllers and variable speed drives,
 - battery chargers and inverters,
 - backed-up power supplies.

■ They include and also guarantee protection against fault currents:

- sinusoidal AC residual currents (AC type),
- pulsed DC residual currents (A type).

They can be adapted to all the application cases defined in standards IEC 60364 and EN 50178.

■ Schneider Electric guarantees that the type B RCCB-ID works correctly in combination with the variable speed drives manufactured by Schneider Electric.

OFsp auxiliary

■ Electrical indication: by OFsp auxiliary mounted to the left.



It has a double changeover switch indicating the "open" or "closed" position of the RCCB-ID B type .

Accessories

- 4P sealable screw shield.

Catalogue numbers

RCCB-ID B type residual current circuit breakers

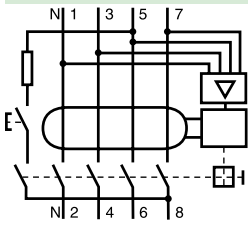
Type		B  				Width in 9 mm module	
		30 mA	300 mA	300 mA 	500 mA		
4P 	Rating	25 A	40 A	63 A	80 A	125 A	8
		16750	16751	-	-		
		16752	16753	16754	16755		
		16756	16757	16758	16759		
		16760	16761	16762	-		
		16763	16764	16765	16766		
Voltage rating (Ue)		230/400 V					
Operating frequency		50 Hz					

Auxiliary

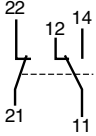
Type			Width in 9 mm module
Contact OFsp	Contact	Voltage	
	1 A	110 V DC	16940
	6 A	230 V AC (AC15)	

Accessory

Type	Number of pole	
Screw shield (set of 10) for upstream or downstream	4P	16939

Connection

■ By tunnel terminals for:

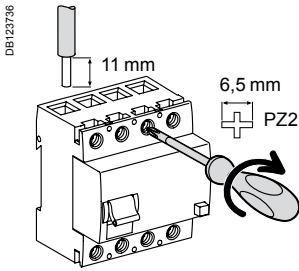

Type	Tightening torque	Copper cables	
		Rigid	Flexible or ferrule
RCCB-ID B type	3 N.m	1 x 1.5 to 50 mm ² 2 x 1.5 to 16 mm ²	1 x 1.5 to 35 mm ² 2 x 1.5 to 16 mm ²
OFsp	0.8 N.m	1 to 1.5 mm ²	1 to 1.5 mm ²

OFsp contact status, depending on the position of the residual current circuit breaker

Type				
RCCB-ID B type	Closed	■	-	-
	Open	-	■	-
	Tripped on fault	-	-	■
Contact OFsp	22/21	Open	Closed	Closed
	12/11	Open	Closed	Closed
	14/11	Closed	Open	Open
	14/11	Closed	Open	Open

Technical data

Electrical characteristics		
According to IEC 60947		
Insulation voltage (U _i)		400 V
Pollution degree		3
Rated impulse withstand voltage (U _{imp})		4 kV
According to IEC/EN 61008-1		
Making and breaking capacity (I _m /I _{dm})	25/40 A	500 A
	63/80 A	800 A
	125 A	1250 A
Surge current withstand (8/20 μs) without tripping	No selective ☒	250 A
	Selective ☑	3 kA
Conditional rated short circuit current (I _{nc} /I _{dc})	25/40 A with FU 80 A gG fuse	10,000 A
	63 A with FU 100 A gG fuse	10,000 A
	80/125 A with FU 125 A gG fuse	10,000 A
Additional characteristics		
Degree of protection	Device only	IP20
	Device in modular enclosure	IP40 with screw shield
Endurance (O-C)	Electrical	> 2 000 cycles
	Mechanical	> 5 000 cycles
Operating temperature		-25°C to +40°C
Storage temperature		-40°C to +85°C



Indication of the status of the RCCB-ID B type via the 3-position toggle and front panel indicator

- Closed (red indicator)
- Tripped on fault (green indicator)
- Open (green indicator)

Weight (g)

Residual current circuit breakers and auxiliary		
Type	RCCB-ID B type	OFsp
4P	450	40

Dimensions (mm)

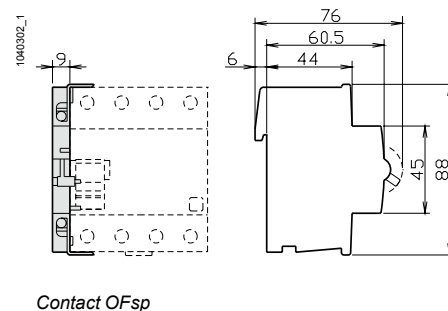
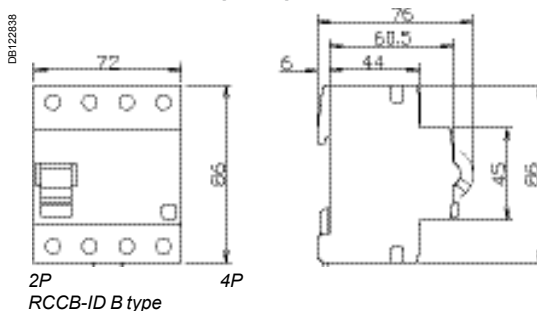



PRF1 12.5r/PRF1 Master/ PRD1 25r/PRD1 Master Type 1 and 2 LV surge arresters

The Type 1 range of surge arresters meets the normative withstand capability of current wave type 10/350 as (8/20 as for Type 2 surge arresters).

It is suitable for use with TT, TN-S, TN-C and 230 V IT earthing connection systems (neutral point connection).

In addition, the PRF1 Master surge arrester covers the 400 V IT system.

PRF1 12.5r and PRD1 surge arresters are fitted with a remote transfer contact to send «end-of-life indication» information.

PRD1 surge arresters are fitted with easy-to-replace withdrawable cartridges.

PRF1 12.5r/PRF1 Master/PRD1 25r/PRD1 Master

The Type 1 surge arrester is recommended for electrical installations in the service sector and industrial buildings protected by a lightning conductor or by a meshed cage.

It protects electrical installations against direct lightning strikes.

It is used to conduct the direct lightning current, propagating from the earth conductor to the network conductors.

It must be installed with an upstream disconnection device, such as a fuse or circuit-breaker, whose breaking capacity must be at least equal to the maximum prospective short-circuit current at the installation point.

PRF1 12.5r and PRD1 25r surge arresters also provide Type 2 protection and protect the electrical installation by finely clipping the lightning wave overvoltages.

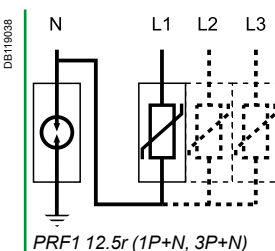

PRF1 12.5r (1P+N, 3P+N)

Type of surge arrester	Product solution	
	1P+N	3P+N
Fixed surge arrester		
PRF1 12.5r T1, T2	16632	16634
PRF1 Master T1		

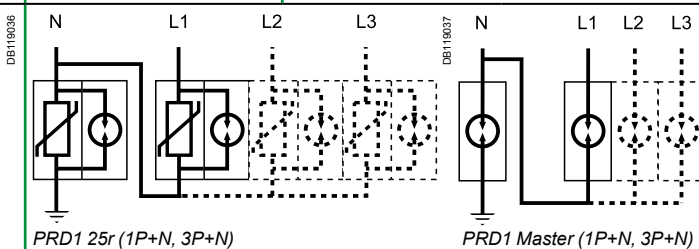

PRD1 25r (1P+N, 3P+N)

PRD1 Master (1P+N, 3P+N)

Cartridge surge arrester	Product solution	
	1P+N	3P+N
PRD1 25r T1 + T2	16330	16332
PRD1 Master T1	16361	16363

PB104275-35



PRF1 12.5r

PB104286-35



PRD1 25r

PB104284-35



PRD1 Master

PRF1 12.5r/PRF1 Master/ PRD1 25r/PRD1 Master Type 1 and 2 LV surge arresters

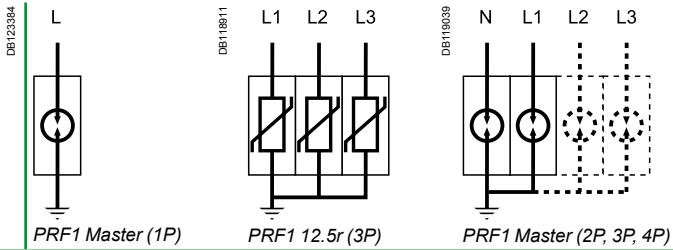

				Neutral point connection	Recommended accessory
1P	2P	3P	4P		
				TT, TN-S	
		16633		TN-C	
	2 x 16630			IT ⁽¹⁾ distributed neutral	16643
16630		3 x 16630		IT ⁽¹⁾ non-distributed neutral	16644
			4 x 16630	IT ⁽¹⁾ distributed neutral	16645

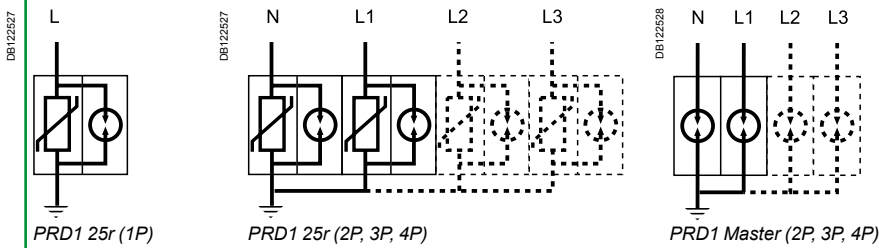

1P	2P	3P	4P		
				TT, TN-S	
	2 x 16329		4 x 16329	IT 230 V	
16329		16331		TN-C	
				TT, TN-S	
	2 x 16360		4 x 16360	IT 230 V	
		16362		TN-C	

(1) Version without indicator light.

PRF1 12.5r/PRF1 Master/ PRD1 25r/PRD1 Master

Type 1 and 2 LV surge arresters

Name of the surge arrester	Nb. of poles	Width	I imp (kA) (10/350) Impulse current		I max (kA) (8/20) Maximal discharge current	In - kA Rated discharge current	Up - kV Degree of protection	Un - V Nominal line voltage	Uc - V Maximum steady state voltage	Cat. no.
			Surge arrester	Surge arrester + disconnecter						
Fixed surge arrester		9 mm modules								
PRF1 12.5r	Type 1 + 2									
	1P+N	4	12.5/50 N/PE		50	25	1.5	230	350	16632
	3P	8	12.5		50	25	1.5	230 / 400	350	16633
	3P+N	8	12.5/50 N/PE		50	25	1.5	230 / 400	350	16634
PRF1 Master	Type 1									
	1P	4	50	35	-	50	1.5	230	440	16630
Withdrawable surge arrester										
PRD1 25r	Type 1 + 2									
	1P	4	25		40	25	1.5	230	350	16329
	1P+N	8	25/100 N/PE		40	25	1.5	230/400	350	16330
	3P	12	25		40	25	1.5	230	350	16331
	3P+N	16	25/100 N/PE		40	25	1.5	230/400	350	16332
PRD1 Master	Type 1									
	1P	4	25		-	25	1.5	230	350	16360
	1P+N	8	25/100 N/PE		-	25	1.5	230/400	350	16361
	3P	12	25		-	25	1.5	230	350	16362
	3P+N	16	25/100 N/PE		-	25	1.5	230/400	350	16363
Spare cartridge										
C1 Master-350	-	4	-	-	-	25	1.5	-	350	16314
C1 25-350	-	23 mm	-	-	-	25	1.5	-	350	16315
C2 40-350	-	12 mm	-	-	-	20	1.4	-	350	16316
C1 Neutral-350	-	4	-	-	-	-	-	-	350	16317

Name of the surge arrester	Spare cartridge		
	Phase		Neutral
	Type 1	Type 2	
PRD1 25r			
PRD1 25r 1P	16315	16316	-
PRD1 25r 1P+N	16315	16316	16317
PRD1 25r 3P	3 x 16315	3 x 16316	-
PRD1 25r 3P+N	3 x 16315	3 x 16316	16317
PRD1 Master			
PRD1 Master 1P	16314	-	-
PRD1 Master 1P+N	16314	-	16317
PRD1 Master 3P	3 x 16314	-	-
PRD1 Master 3P+N	3 x 16314	-	16317

PRF1 12.5r/PRF1 Master/ PRD1 25r/PRD1 Master Type 1 and 2 LV surge arresters

Technical data		PRF1 12.5r	PRF1 Master	PRD1 25r	PRD1 Master
Operating frequency		50 Hz	50/60 Hz	50 Hz	50 Hz
Degree of protection	Front panel	IP40	IP40	IP40	IP40
	Terminals	IP20	IP20	IP20	IP20
	Impacts	IK05	IK05	IK05	IK05
Response time		≤ 25 ns	≤ 1 μs	≤ 25 ns	≤ 100 ns
End-of-life indication		Green: correct operation	-	White: correct operation	White: correct operation
		Red: at end of life	-	Red: at end of life	Red: at end of life
	Remote notification	1 A/250 V AC	-	1 A/250 V AC. 0.2 A/125 V DC	1 A/250 V AC. 0.2 A/125 V DC
By tunnel terminal	Rigid cable	10...35 mm ²	10...50 mm ²	2.5...35 mm ²	10...35 mm ²
	Flexible cable	10...25 mm ²	10...35 mm ²	2.5...25 mm ²	10...25 mm ²
Operating temperature		-25°C to +60°C	-40°C to +85°C	-25°C to +60°C	-25°C to +60°C
Standards	Type 1	IEC 61643-1 [T1]. EN 61643-11 Type 1	IEC 61643-1 [T1]. EN 61643-11 Type 1	IEC 61643-1 [T1]. EN 61643-11 Type 1	IEC 61643-1 [T1]. EN 61643-11 Type 1
	Type 2	IEC 61643-1 [T2]. EN 61643-11 Type 2	-	IEC 61643-1 [T2]. EN 61643-11 Type 2	-
Certification		CE	KEMAKEUR, CE	KEMAKEUR, CE	CE

Choice of disconnecter / surge arrester		Isc: prospective short-circuit current at the installation point				
Type	Iimp: impulse current	10 kA	15 kA	25 kA	36 kA	50 kA
PRF1 12.5r	12.5 kA	C120N 80 A curve C	C120H 80 A curve C or NG125N 80 A curve C	NG125N 80 A curve C	Contact us	
PRF1 Master	35 kA	Compact NSX160B 160 A TM			Compact NSX160F 160 A	Compact NSX160N 160 A
PRD1 25r	25 kA	NG125N 80 A curve C			-	
PRD1 Master	25 kA	NG125N 80 A curve C			NG125H 80 A curve C	NG125L 80 A curve C

DB123370



Accessories

Type	Number of poles	Cat. no.
4P Wiring comb busbars	4	16643
6P Wiring comb busbars	6	16644
8P Wiring comb busbars	8	16645
200 mm flexible cable (PRF1 Master)		16646

The iPF multi-pole single-piece surge arrester range is adapted for earthing systems: TT, TN-S, TN-C.

Type 2 surge arresters are tested with a 8/20 μ s current wave.

Type 3 surge arresters are tested with a 12/50 μ s and 8/20 μ s combined wave.

Each surge arrester in the range has a specific application:

■ **incoming protection (type 2):**

- the iPF65(r) is recommended for a very high risk level (strongly exposed site)
- the iPF40(r) is recommended for a high risk level
- the iPF20 is recommended for a medium risk level

■ **secondary protection (type 2 or 3):**

- the iPF8 ensures secondary protection of loads to be protected and is placed in cascade with the incoming surge arresters. This surge arrester is required when the loads to be protected are at a distance of more than 30 m from the incoming surge arrester.

The iPF surge arresters with “r” indication have remote transfer of the information: “surge arrester to be replaced”.

PB105278-35



1P+N.

PB105280-35



3P+N.

Rated discharge current (Imax) / Nominal discharge current (In)	Type of protection		Network							
	Incoming	Secondary (type 2 or 3)	N L1 L2 L3		N L1 L2 L3					
			1P+N	3P+N	1P	2P	3P	4P		
65 kA / 20 kA										
	iPF65		A9L15684		A9L15683					
						A9L15584				
				A9L15685				A9L15581		
				A9L15586					A9L15585	
40 kA / 15 kA										
High risk level	iPF40		A9L15687		A9L15686					
						A9L15587				
				A9L15690				A9L15582		
				A9L15688					A9L15590	
									A9L15588	
20 kA / 5 kA										
Medium risk level	iPF20		A9L15692		A9L15691					
						A9L15592				
				A9L15693				A9L15597		
									A9L15593	
8 kA / 2.5 kA										
Secondary protection: placed near the loads to be protected when they are at a distance of more than 30 m from the incoming surge arrester		iPF8	A9L15695		A9L15694					
						A9L15595				
				A9L15696				A9L15598		
									A9L15596	

Surge arrester/circuit breaker association





Type of surge arrester	Associated circuit breaker
iPF65	Curve C 50 A
iPF40	Curve C 40 A
iPF20	Curve C 25 A
iPF8	Curve C 20 A

	Earthing system	Transfer	Surge arrester name	Width in mod. of 9 mm	Up - (kV) Voltage protection level			Un - (V) Rated voltage network	Uc - (V) Maximum continuous operating voltage		
					CM*		DM*		CM*		DM*
					L/±	N/±	L/N		L/±	N/±	L/N
iPF65											
	TT & TN		iPF65 1P	2	≤ 1.5	-	-	230	340	-	-
	TT & TN-S		iPF65 1P+N	4	-	≤ 1.5	≤ 1.5		-	260	340
	TN-C		iPF65 2P		≤ 1.5	≤ 1.5	-		340	340	-
	TN-C		iPF65 3P	8	≤ 1.5	-	-	230/400	340	-	-
	TT & TN-S	■	iPF65r 3P+N		-	≤ 1.5	≤ 1.5		-	260	340
	TT & TN-S		iPF65 3P+N		-	≤ 1.5	≤ 1.5		-	260	340
	TN-C	■	iPF65r 4P		≤ 1.5	≤ 1.5	-		340	340	-
iPF40											
	TT & TN		iPF40 1P	2	≤ 1.5	-	-	230	340	-	-
	TT & TN-S		iPF40 1P+N	4	-	≤ 1.5	≤ 1.5		-	260	340
	TN-C		iPF40 2P		≤ 1.5	≤ 1.5	-		340	340	-
	TN-C		iPF40 3P	8	≤ 1.5	-	-	230/400	340	-	-
	TT & TN-S	■	iPF40r 3P+N		-	≤ 1.5	≤ 1.5		-	260	340
	TT & TN-S		iPF40 3P+N		-	≤ 1.5	≤ 1.5		-	260	340
	TN-C	■	iPF40r 4P		≤ 1.5	≤ 1.5	-		340	340	-
	TN-C		iPF40 4P		≤ 1.5	≤ 1.5	-		340	340	-
iPF20											
	TT & TN		iPF20 1P	2	≤ 1.1	-	-	230	340	-	-
	TT & TN-S		iPF20 1P+N	4	-	≤ 1.5	≤ 1.1		-	260	340
	TN-C		iPF20 2P		≤ 1.1	≤ 1.1	-		340	340	-
	TN-C		iPF20 3P	8	≤ 1.1	-	-	230/400	340	-	-
	TT & TN-S		iPF20 3P+N		-	≤ 1.5	≤ 1.1		-	260	340
	TN-C		iPF20 4P		≤ 1.1	≤ 1.1	-		340	340	-
iPF8 (1) Type 2 / Type 3											
	TT & TN		iPF8 1P	2	≤ 1 / ≤ 1.1	-	-	230	340	-	-
	TT & TN-S		iPF8 1P+N	4	-	≤ 1.5 / ≤ 1.2	≤ 1.4 / ≤ 1.1		-	260	340
	TN-C		iPF8 2P		≤ 1 / ≤ 1.1	≤ 1 / ≤ 1.1	-		340	340	-
	TN-C		iPF8 3P	8	≤ 1 / ≤ 1.1	-	-	230/400	340	-	-
	TT & TN-S		iPF8 3P+N		-	≤ 1.5 / ≤ 1.2	≤ 1.4 / ≤ 1.1		-	260	340
	TN-C		iPF8 4P		≤ 1 / ≤ 1.1	≤ 1 / ≤ 1.1	-		340	340	-

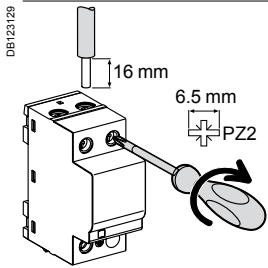
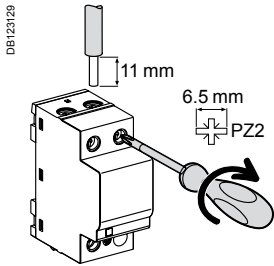
* **CM**: common mode (phase to earth and neutral to earth). * **DM**: differential mode (phase to neutral). (1) **Uoc**: combined waveform voltage: 10 kV.

Connection



Type	Tightening torque	Copper cables	
		Rigid	Flexible or ferrule
iPF8 / 20	Ph / N	DBI122846 	DBI122846 
	⊥		
iPF40 / 65	Ph / N	DBI122846 	DBI122846 
	⊥		

Technical data

Main characteristics	
Operating frequency	50/60 Hz
Operating voltage (Ue)	230/400 V AC
Permanent operating current (Ic)	< 1 mA
Response time	< 25 ns
End of life indication:	Green In operation
by green/red mechanical indicator	Red At end of life
End of life remote indication	By contact NO, NC 250 V / 0.25 A
Additional characteristics	
Operating temperature	-25°C to +60°C
Type of connection terminals	Tunnel terminals, 2.5 to 35 mm ²
Standards	IEC 61643-1 T2 and EN 61643-11 Type 2

iPF surge arresters

Type 2 or 3 LV surge arresters (cont.)

Weight (g)

Surge arrester	
Type	iPF
1P	125
2P	210
3P	335
4P	420

Dimensions (mm)

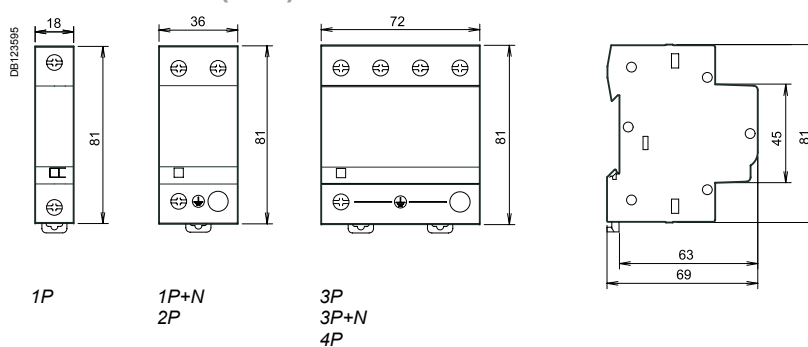

iPRD surge arresters

Type 2 or 3 LV withdrawable surge arresters

iPRD withdrawable surge arresters allow quick replacement of damaged cartridges.



1P+N



3P



3P+N



Cartridge

Rated discharge current (I _{max}) / Nominal discharge current (I _n)	Type of protection	Network							
		Incoming	Secondary	1P+N	3P+N	1P	2P	3P	4P
65 kA / 20 kA Very high risk level (strongly exposed site)	iPRD65								
				A9L16555					
				A9L16556					
			A9L16557						
							A9L16442		
								A9L16558	
								A9L16443	
				A9L16559					
									A9L16659
40 kA / 15 kA High risk level	iPRD40					A9L16561			
						A9L16566			
			A9L16562						
			A9L16567						
							A9L16444		
							A9L16667		
								A9L16445	
								A9L16568	
								A9L16563	
				A9L16564					
				A9L16569					
									A9L16597
									A9L16664
									A9L16669
20 kA / 5 kA Medium risk level	iPRD20					A9L16571			
			A9L16672						
			A9L16572						
							A9L16446		
								A9L16447	
								A9L16573	
						A9L16674			
						A9L16574			
									A9L16599
									A9L16673
8 kA / 2.5 kA Secondary protection: placed near the loads to be protected when they are at a distance of more than 30 m from the incoming surge arrester	iPRD8					A9L16576			
			A9L16677						
			A9L16577						
							A9L16448		
								A9L16449	
								A9L16578	
						A9L16679			
						A9L16579			
									A9L16678
									A9L16680

Spare cartridges		
Type	Spare cartridges for	Cat. no
C 65-460	iPRD65r IT	A9L16682
C 65-340	iPRD65r	A9L16681
C 40-460	iPRD40r IT	A9L16684
C 40-340	iPRD40, iPRD40r	A9L16685
C 20-460	iPRD20r IT	A9L16686
C 20-340	iPRD20, iPRD20r	A9L16687
C 8-460	iPRD8r IT	A9L16688
C 8-340	iPRD8, iPRD8r	A9L16689
C neutral	All products	A9L16691

Surge arrester/circuit breaker association	
Type of surge arrester	Associated circuit breaker
iPRD65	Curve C 50 A
iPRD40	Curve C 40 A
iPRD20	Curve C 25 A
iPRD8	Curve C 20 A

iPRD surge arresters

Type 2 or 3 LV withdrawable surge arresters (cont.)

	Earthing system	Transfer	Surge arrester name	Width in mod. of 9 mm	Up - (kV) Voltage protection level			Un - (V) Rated voltage network	Uc - (V) Maximum continuous operating voltage		
					CM*		DM*		CM*		DM*
					L/±	N/±	L/N		L/±	N/±	L/N
iPRD65											
	IT	■	iPRD65r 1P IT	2	≤ 2	-	-	230	460	-	-
	TT & TN	■	iPRD65r 1P		≤ 1.5	-	-	-	340	-	-
	TT & TN-S	■	iPRD65r 1P+N	4	-	≤ 1.5	≤ 1.5	-	-	260	340
	TN-C	■	iPRD65r 2P		≤ 1.5	≤ 1.5	-	-	340	340	-
	IT	■	iPRD65r 3P IT	6	≤ 2	-	-	230/400	460	-	-
	TN-C	■	iPRD65r 3P		≤ 1.5	-	-	-	340	-	-
	TT & TN-S	■	iPRD65r 3P+N	8	-	≤ 1.5	≤ 1.5	-	-	260	340
	TN-C	■	iPRD65r 4P		≤ 1.5	≤ 1.5	-	-	340	340	-
iPRD40											
	TT & TN	■	iPRD40r 1P	2	≤ 1.4	-	-	230	340	-	-
	TT & TN		iPRD40 1P		≤ 1.4	-	-	-	340	-	-
	TT & TN-S	■	iPRD40r 1P+N	4	-	≤ 1.4	≤ 1.4	-	-	260	340
	TT & TN-S		iPRD40 1P+N		-	≤ 1.4	≤ 1.4	-	-	260	340
	TN-C	■	iPRD40r 2P		≤ 1.4	≤ 1.4	-	-	340	340	-
	TN-C		iPRD40 2P		≤ 1.4	≤ 1.4	-	-	340	340	-
	TN-C	■	iPRD40r 3P	6	≤ 1.4	-	-	230/400	340	-	-
	TN-C		iPRD40 3P		≤ 1.4	-	-	-	340	-	-
	IT	■	iPRD40r 3P IT		≤ 2	-	-	-	460	-	-
	TT & TN-S	■	iPRD40r 3P+N	8	-	≤ 1.4	≤ 1.4	-	-	260	340
	TT & TN-S		iPRD40 3P+N		-	≤ 1.4	≤ 1.4	-	-	260	340
	IT	■	iPRD40r 4P IT		≤ 2	≤ 2	-	-	460	460	-
	TN-C	■	iPRD40r 4P		≤ 1.4	≤ 1.4	-	-	340	340	-
	TN-C		iPRD40 4P		≤ 1.4	≤ 1.4	-	-	340	340	-
iPRD20											
	TT & TN		iPRD20 1P	2	≤ 1.1	-	-	230	340	-	-
	TT & TN-S	■	iPRD20r 1P+N	4	-	≤ 1.4	≤ 1.1	-	-	260	340
	TT & TN-S		iPRD20 1P+N		-	≤ 1.4	≤ 1.1	-	-	260	340
	TN-C		iPRD20 2P		≤ 1.1	≤ 1.1	-	-	340	340	-
	TN-C		iPRD20 3P	6	≤ 1.1	-	-	230/400	340	-	-
	IT	■	iPRD20r 3P IT		≤ 1.6	-	-	-	460	-	-
	TT & TN-S	■	iPRD20r 3P+N	8	-	≤ 1.4	≤ 1.1	-	-	260	340
	TT & TN-S		iPRD20 3P+N		-	≤ 1.4	≤ 1.1	-	-	260	340
	IT	■	iPRD20r 4P IT		≤ 1.6	≤ 1.6	-	-	460	460	-
	TN-C		iPRD20 4P		≤ 1.1	≤ 1.1	-	-	340	340	-
iPRD8 (1) Type 2 / Type 3											
	TT & TN		iPRD8 1P	2	≤ 1 / ≤ 1	-	-	230	340	-	-
	TT & TN-S	■	iPRD8r 1P+N	4	-	≤ 1.4 / ≤ 1	≤ 1 / ≤ 1.1	-	-	260	340
	TT & TN-S		iPRD8 1P+N		-	≤ 1.4 / ≤ 1	≤ 1 / ≤ 1.1	-	-	260	340
	TN-C		iPRD8 2P		≤ 1 / ≤ 1	≤ 1 / ≤ 1	-	-	340	340	-
	TN-C		iPRD8 3P	6	≤ 1 / ≤ 1	-	-	230/400	340	-	-
	IT	■	iPRD8r 3P IT		≤ 1.4 / ≤ 1.6	-	-	-	460	-	-
	TT & TN-S	■	iPRD8r 3P+N	8	-	≤ 1.4 / ≤ 1	≤ 1 / ≤ 1.1	-	-	260	340
	TT & TN-S		iPRD8 3P+N		-	≤ 1.4 / ≤ 1	≤ 1 / ≤ 1.1	-	-	260	340
	IT	■	iPRD8r 4P IT				-	-	460	460	-
	TN-C		iPRD8 4P		≤ 1 / ≤ 1	≤ 1 / ≤ 1	-	-	340	340	-

* **CM**: common mode (phase to earth and neutral to earth). * **DM**: differential mode (phase to neutral). (1) **Uoc**: combined waveform voltage: 10 kV.

iPRD surge arresters

Type 2 or 3 LV withdrawable surge arresters (cont.)

Connection

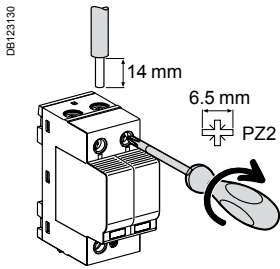

Type	Tightening torque	Copper cables	
		Rigid	Flexible or ferrule
iPRD	2 N.m	2.5 to 25 mm ²	2.5 to 16 mm ²

Technical data

Main characteristics		
Operating frequency	50/60 Hz	
Operating voltage (U _e)	230/400 V AC	
Permanent operating current (I _c)	< 1 mA	
Response time	< 25 ns	
End of life indication: by mechanical indicator	White	In operation
	Red	At end of life
End of life remote indication	By contact NO, NC 250 V / 0.25 A	
Additional characteristics		
Operating temperature	-25°C to +60°C	
Type of connection terminals	Tunnel terminals, 2.5 to 35 mm ²	
Standards	IEC 61643-1 T2 and EN 61643-11 Type 2	

iPRD surge arresters

Type 2 or 3 LV withdrawable surge arresters (cont.)

Weight (g)

Surge arrester	
Type	iPRD
1P	115
2P	220
3P	340
4P	450

Dimensions (mm)

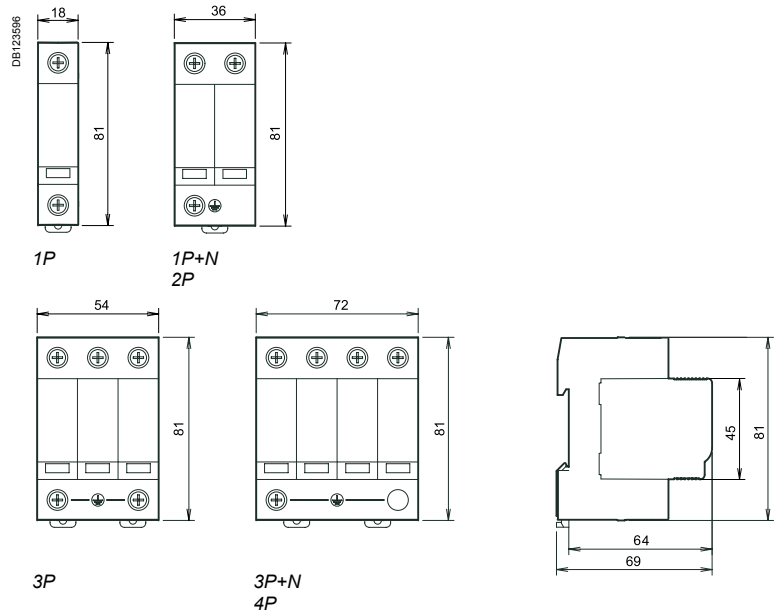



Connection

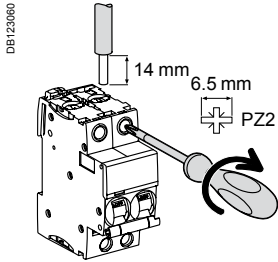

Type	Rating	Tightening torque	Without accessory		With accessories			
			Copper cables		50 mm ² Al terminal	Screw-on connection for ring terminal	Multi-cables terminal	
			Rigid	Flexible or ferrule			Rigid cables	Flexible cables
iC60	0.5 to 25 A	2 N.m	1 to 25 mm ²	1 to 16 mm ²	-	Ø 5 mm	-	-
	32 to 63 A	3.5 N.m	1 to 35 mm ²	1 to 25 mm ²	50 mm ²	-	3 x 16 mm ²	3 x 10 mm ²
Vigi iC60	25 A	2 N.m	1 to 25 mm ²	1 to 16 mm ²	-	-	-	-
	40 to 63 A	3.5 N.m	1 to 35 mm ²	1 to 25 mm ²	-	-	-	-
iID	16 to 100 A	3.5 N.m	1 to 35 mm ²	1 to 25 mm ²	50 mm ²	Ø 5 mm	3 x 16 mm ²	3 x 10 mm ²

7	Splitter blocks	Multiclip	see module	CA907004
		Distribloc	see module	CA907003
8	50 mm ² Al terminal			27060
9	Screw-on connection for ring terminal			27053
10	Multi-cables terminal		4 parts	19091
			3 parts	19096
11	Comb busbar		see module	91906

Mounting accessories

12	Sealable terminal shields for top and bottom connection	1P (set of 2)	A9A26975
		2P (set of 2)	A9A26976
		3P	1P + 2P
		4P	2P + 2P
13	Interpole barrier	(set of 10)	A9A27001
14	Screw shields	4P (set of 20)	A9A26981
14'	Screw shields	Vigi iC60 (set of 12)	A9A26982
15	Clip-on terminal markers		see module CA907001
16	9 mm spacer		A9A27062
17	Padlocking device	(set of 10)	A9A26970
18	Plug-in base		A9A27003
19	Rotary handle	With handle black	A9A27005
		With handle red	A9A27006
		Adapter mechanism without handle	A9A27008

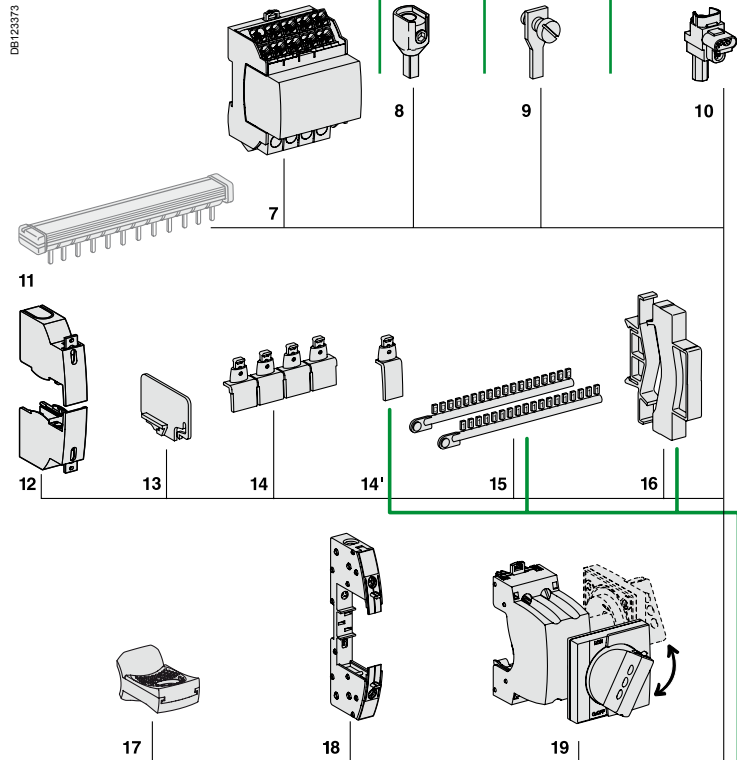

Electrical auxiliaries

Indication

4	iOF/SD+OF auxiliary contact (OF+SD or OF+OF combination switch)	A9A26929
5	iSD fault indicating contact	A9A26927
6	iOF open/close auxiliary contact	A9A26924

Tripping devices

2	iMN undervoltage release or iMNx undervoltage release delayed or iMNx undervoltage release with external feeding	see module CA907002
3	Shunt release iMX, iMX+OF overvoltage release IMSU	see module CA907002

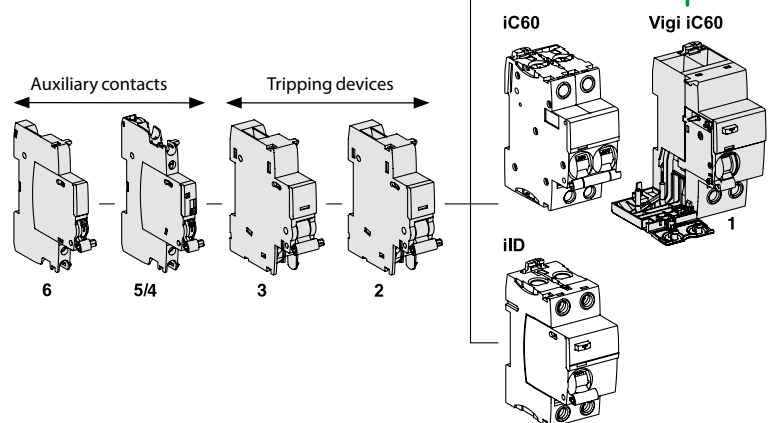







Vigi iC60



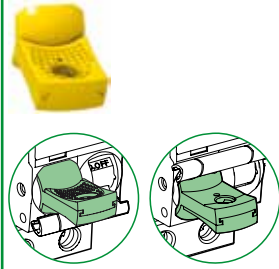
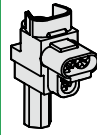
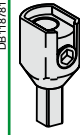



1	Vigi iC60 add-on residual current device	see module CA902005
---	--	---------------------

Tripping devices must be mounted first.
Respect specified position for SD functions.

Accessories for iC60, iID, iSW-NA, Reflex iC60, RCA and ARA

		Mounting			
Accessories	Rotary handle		Plug-in base	Padlocking device	
					
Function					
Front or side-mounted control <ul style="list-style-type: none"> ■ Degree of protection: IP55 rotary handle ■ Installation: <ul style="list-style-type: none"> □ the control mechanism is mounted on the device □ the rotary handle is fixed to the side of the enclosure ■ Front-mounted (on door or faceplate) ■ Prevents the door from opening when the circuit breaker is in the ON position (can be deactivated) ■ Can be padlocked when the device is in the "open" position (can be padlocked with the device in the "closed" position subject to adaptation) ■ Can be locked by padlock of (dia. 5 to 8 mm), not supplied with the device 		<ul style="list-style-type: none"> ■ The Laser Square tool brings the associated alignment marks accurately to align the circuit breaker with the rotary handle 	Allows a breaker to be removed or replaced quickly, without handling <ul style="list-style-type: none"> ■ Degree of protection: IP20 ■ Consists of: <ul style="list-style-type: none"> □ 2 blades to be fastened in the device □ 2 blades to be fastened in the cable up to 35 mm; rigid, 25 mm □ in universal enclosure on horizontal rail ■ Not compatible with iC60 and auxiliaries 	Used to padlock breaker in open or closed position <ul style="list-style-type: none"> ■ Sealable (max. diameter: 1.2 mm) ■ Locking device for the breaker ■ Prevents tripping of the breaker in the event of faults ■ Not compatible with iC60 and auxiliaries 	
Catalogue numbers Set of		A9A27005 black handle 1	A9A27006 red handle 1	A9A27007 no handle 1	A9A27008 black handle; Rotary handle: A9A27005 black handle; Rotary handle: A9A27008 no handle; Rotary handle: GVP01; Padlocking device: A9A26970; Screw handle: A9A26981; Terminal shield: A9A26975; Terminal shield: A9A26976; Inter-pole barrier: A9A27001; Spacer: A9A27062
Suitability					
iC60		■ 2P, 3P, 4P		■	
iC60 + Vigi iC60		■ 2P, 3P, 4P		■	
iID		-		■ ≤ 63 A	
Reflex iC60 or RCA+iC60 or ARA+iC60		-		■	
ARA+iID		-		■	
iSW-NA		-		■	
Connection					
Accessories	Multi-cable terminal		50 mm ² terminal AI	Screw-on connection for ring terminal	
					
Function					
For 3 copper cables: <ul style="list-style-type: none"> ■ Rigid up to 16 mm² ■ Flexible up to 10 mm² 		For aluminium cables from 16 to 50 mm²		For lug tipped cables, front or rear mounting	
					
Catalogue numbers Set of		19091 4	19096 3	27060 1	27053 8
iC60 ≤ 25 A Reflex iC60 ≤ 25 A		-		■	
iC60 > 25 A Reflex iC60 40 A		■		■	
Vigi iC60		-		-	
iID		■		■	
iSW-NA		■		■	
Tightening torque		2 N.m		10 N.m	
Length stripping		11 mm		13 mm	
Tools to use		Dia. 5 mm or PZ2		Hc 1/5" or 5 mm	

Accessories for iC60, iID, iSW-NA, Reflex iC60, RCA and ARA (cont.)

Security						
Accessories	Screw shield		Terminal shield		Inter-pole barrier	Spacer
 PB104489-14	 PB104488-14	 PB104502-35	 PB104503-35	 PB104484-30	 PB104483-35	 PB104483-35
Function						
Prevents any contact with the connecting screws <ul style="list-style-type: none"> Upgrades degree of protection to IP20D Sealable, max. diameter 1.2 mm 		Prevents any contact with the terminals <ul style="list-style-type: none"> Upgrades degree of protection to IP20D Sealable, max. diameter 1.2 mm Set of two, for upstream and downstream terminals For 3 poles: A9A26975 + A9A26976 For 4 poles: 2 X A9A26976 		Enhances insulation between connections: cables, terminals, lugs, etc		<ul style="list-style-type: none"> Used to: <ul style="list-style-type: none"> complete rows separate devices. Width: 1 x 9 mm module Allows cable routing from one row to another, (above and below), up to 6 mm²
Catalogue numbers	A9A26982	A9A26981	A9A26975	A9A26976	A9A27001	A9A27062
Set of	12 x 1 pole	20 x 4 poles (splittable)	2 x 1 pole	2 x 2 poles	10	5
Suitability						
iC60	–	■	■	■	■	■
Vigi iC60	■	–	–	–	–	■
iID	–	■	–	■	■	■
Reflex iC60 or RCA+iC60 or ARA+iC60	–	■	■	■	■	■
ARA+iID	–	■	–	■	■	■
iSW-NA	–	■	–	■	■	■

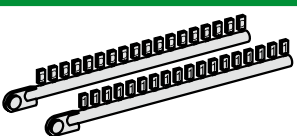
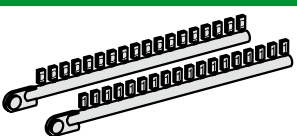
Marking						
Accessories	Marker strip					
 DB118765						
Used for connection identification						
Catalogue numbers	0: AB1-R0 1: AB1-R1 2: AB1-R2 3: AB1-R3 4: AB1-R4	5: AB1-R5 6: AB1-R6 7: AB1-R7 8: AB1-R8 9: AB1-R9	A: AB1-GA B: AB1-GB C: AB1-GC D: AB1-GD E: AB1-GE F: AB1-GF G: AB1-GG H: AB1-GH I: AB1-GI	J: AB1-GJ K: AB1-GK L: AB1-GL M: AB1-GM N: AB1-GN O: AB1-GO P: AB1-GP Q: AB1-GQ R: AB1-GR	S: AB1-GS T: AB1-GT U: AB1-GU V: AB1-GV W: AB1-GW X: AB1-GX Y: AB1-GY Z: AB1-GZ	+ : AB1-R12 - : AB1-R13 blank: AB1-RV
Set of	250					
iC60 / Reflex iC60	■ 4 markers max. per pole					
Vigi iC60	■ 4 markers max. per device					
iID	■ 4 markers max. per device					
iSW-NA	■ 4 markers max. per device					

Electrical auxiliaries for iC60, iID, iSW-NA, RCA and ARA

■ The electrical auxiliaries are combined with iC60 circuit breakers, iID residual current circuit breakers, remote tripping switch disconnectors iSW-NA, RCA remote controls and ARA automatic reclosers; they enable tripping or remote indication of their position (open/closed/tripped) upon a fault.

■ They are fastened by clips (without tools) to the left side of the breaker.

■ The iOF/SD+OF auxiliary is a 2-in-1 product: via a mechanical selector switch, it provides two contacts, OF+SD or OF+OF.

IEC/EN 60947-1

■ Tripping auxiliaries:

- iMN: undervoltage release
- iMNs: delayed undervoltage release
- iMNx: undervoltage release, independent from supply voltage
- iMSU: overvoltage release
- iMX: shunt release
- iMX+OF: shunt release with open/close contact.

IEC/EN 60947-5-1

■ Indication auxiliaries:





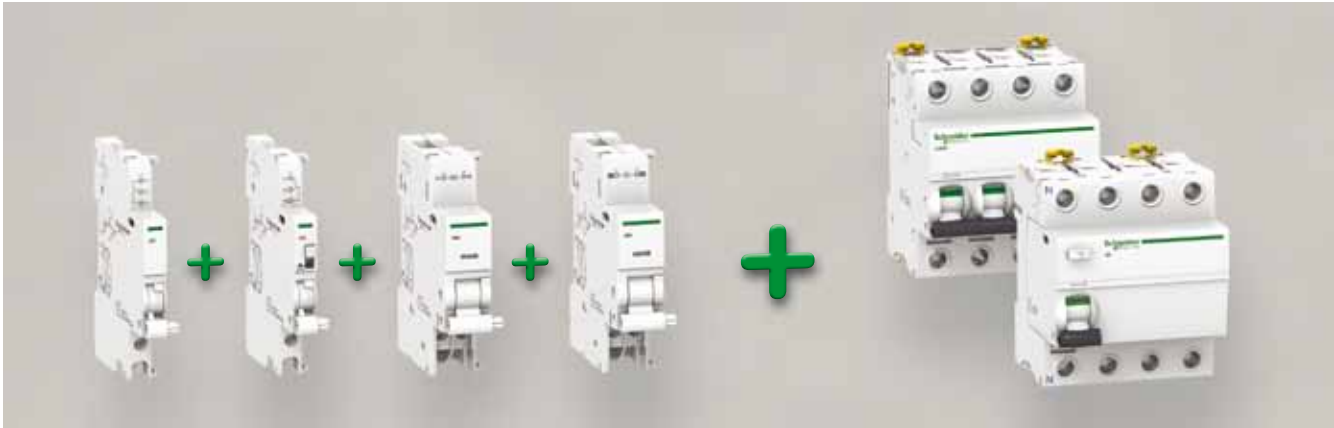





- iOF: open/close contact
- iSD: fault indicating contact
- iOF/SD+OF: open/close contact and switchable OF or SD contact.

DB123545



Electrical auxiliaries for iC60, iID, iSW-NA, RCA and ARA (cont.)

Combination table

Electrical auxiliaries			Remote control	Devices	
Indication auxiliaries			ARA automatic recloser or RCA remote control	Vigi	
Position		Max quantity			
Left	Right				
1 iOF/SD+OF	+ 1 iOF/SD+OF	+ 1 (iMX or iMN or iMSU)	-	 iC60	 Vigi iC60
Or 1 iOF	+ 1 (iSD or iOF or iOF/SD+OF)	+ 2 (iMX or iMN or iMSU)			
Or None	+ None	+ 3x iMSU			
None	+ 1 (iSD or iOF or iOF/SD+OF)	+ 1 (iMX or iMN or iMSU)		 iID/iSW-NA*	-
Or 1 iOF	+ 1 (iSD or iOF or iOF/SD+OF)	+ None	 ARA	 iC60	 Vigi iC60
None	+ 1 (iSD or iOF or iOF/SD+OF)	+ 1 (iMX or iMN or iMSU)		 iID/iSW-NA*	-
Or 1 iOF	+ 1 (iSD or iOF or iOF/SD+OF)	+ None	 RCA	 iC60	 Vigi iC60

Other possible associations: see technical pages

Tripping devices must be mounted first.



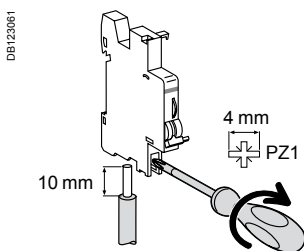

*iSW-NA: the iSD auxiliary contact must be associated with an auxiliary (iMN, iMX, iMX+OF); it indicates that the remote tripping switch disconnecter has been tripped open.

Connection





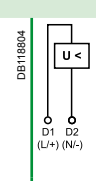
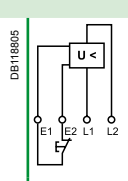
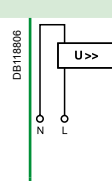

Type	Tightening torque	Copper cables		Multi-cables terminal	
		Rigid	Flexible	Rigid	With ferrule
Indication auxiliaries	1 N.m	1 to 4 mm ²	0.5 to 2.5 mm ²	2 x 2.5 mm ²	2 x 1.5 mm ²
Tripping auxiliaries	1 N.m	1 to 6 mm ²	0.5 to 4 mm ²	2 x 2.5 mm ²	2 x 2.5 mm ²

Electrical auxiliaries for iC60, iID, iSW-NA, RCA and ARA (cont.)

		Tripping							
Auxiliaries		iMN	iMNs	iMNx	iMSU				
Type		Undervoltage release				Overvoltage release			
		Instantaneous	Delayed	Independent of the supply voltage					
	 PB104477-35	 PB104478-35	 PB104480-35	 PB104479-35					
Function	<ul style="list-style-type: none"> Trips the device with which it is combined when its input voltage decreases (between 70 % and 35 % U_n). Prevents device closing again until its input voltage is restored 				<ul style="list-style-type: none"> Switches off the power supply by opening the breaker with which it is combined, in the event that the phase/neutral voltage is exceeded (loss of neutral). For a four-phase network, use three iMSU tripping auxiliaries 				
			<ul style="list-style-type: none"> Not tripping on transient voltage dip (up to 0.2 s) 	<ul style="list-style-type: none"> Separate input and power supply 	<ul style="list-style-type: none"> Tripping voltage: 275 V AC 	<ul style="list-style-type: none"> Tripping voltage: 255 V AC 			
Wiring diagrams	 DB118804	 DB118805		 DB118806					
Use	<ul style="list-style-type: none"> Emergency stoppage by normally closed push button Ensures the safety of power supply circuits for several machines by preventing "uncontrolled" restarting 			<ul style="list-style-type: none"> Emergency stoppage with fail-safe principle Insensitive to control circuit voltage variation to increase service continuity 		<ul style="list-style-type: none"> Protection of equipment against overvoltages on the electrical network (neutral conductor break) Voltage monitoring between phase and neutral conductors 			
Catalogue numbers	A9A26960	A9A26961	A9A26959	A9A26963	A9A26969	A9A26971	A9A26979	A9A26479	
Technical specifications									
Rated voltage (Ue)	V AC	220...240	48	115	220...240	220...240	380...415	230	230
	V DC	-	48	-	-	-	-	-	-
Operating frequency	Hz	50/60	400	50/60	50/60	50/60	50/60	50/60	50/60
Red mechanical indicator		On front face		On front face	On front face	On front face			
Test function		-		-	-	-			
Width in 9 mm modules		2		2	2	2			
Operating current		-		-	-	-			
Number of contacts		-		-	-	-			
Operating temperature	°C	-35...+70		-35...+70	-35...+70	-35...+70			
Storage temperature	°C	-40...+85		-40...+85	-40...+85	-40...+85			

Electrical auxiliaries for iC60, iID, iSW-NA, RCA and ARA (cont.)

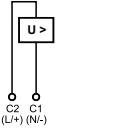
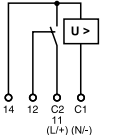
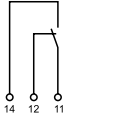
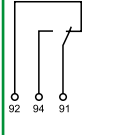
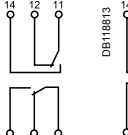
			Indication					
iMX			iMX+OF		iOF	iSD	iOF/SD+OF	
Shunt release			With Open/Close auxiliary contact		Open/close auxiliary contact	Fault indicating contact	Double open/close or fault indicating contact	
								
PB104496-35			PB104497-35		PB104474-35	PB104476-35	PB104475-35	
<ul style="list-style-type: none"> Trips the breaker when powered 			<ul style="list-style-type: none"> Includes an open/close contact (OF) to indicate the "open" or "closed" position of the breaker 		<ul style="list-style-type: none"> Changeover contact indicates "open" or "closed" position of the breaker 	<ul style="list-style-type: none"> Changeover contact indicates position of the breaker; upon: <ul style="list-style-type: none"> electrical fault action on tripping auxiliary Same indication as VISI-TRIP 	<ul style="list-style-type: none"> The iOF/SD+OF auxiliary is a 2-in-1 product: via a mechanical selector switch, it provides two contacts, OF+SD or OF+OF 	
								
DE123012			DE118808		DE118810	DE118811	DE118812	
<ul style="list-style-type: none"> Emergency stoppage by normally open push button 			<ul style="list-style-type: none"> Emergency stoppage by normally open push button Remote indication of the position of the associated breaker 		<ul style="list-style-type: none"> Remote indication of the position of the associated breaker 	<ul style="list-style-type: none"> Remote indication of tripping upon a fault of the associated breaker 	<ul style="list-style-type: none"> Remote indication of position and/or tripping upon a fault of the associated breaker 	
A9A26476 A9A26477 A9A26478			A9A26946 A9A26947 A9A26948		A9A26924	A9A26927	A9A26929	
100...415	48	12...24	100...415	48	12...24	240...415	240...415	240...415
110...130	48	12...24	110...130	48	12...24	24...130	24...130	24...130
50/60			50/60		50/60	50/60	50/60	50/60
On front face			On front face		On front face	On front face	On front face	On front face
-			-		On toggle	On toggle	On toggle	On toggle
2			2		1	1	1	1
-			<ul style="list-style-type: none"> ≤ 24 V DC 6 A 48 V DC 2 A ≤ 130 V DC 1 A ≤ 240 V AC 6 A 415 V AC 3 A 		<ul style="list-style-type: none"> 24 V DC 6 A 48 V DC 2 A 60 V DC 1.5 A 130 V DC 1 A 240 V AC 6 A 415 V AC 3 A 			
-			1 NO/NC		1 NO/NC	1 NO/NC	1 NO/NC + 1 NO/NC	
-35...+70			-35...+70		-35...+70	-35...+70	-35...+70	-35...+70
-40...+85			-40...+85		-40...+85	-40...+85	-40...+85	-40...+85

Connection

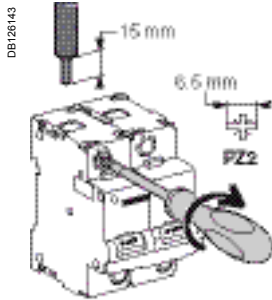

Type	Rating	Tightening torque	Without access.		With accessories			
			Copper cables		50 mm ² Al terminal	Screw-on connection for ring terminal	Multi-cable terminal	
			Rigid	Flexible or with ferrule			Rigid cables	Flexible cables
C120	10 to 125 A	3.5 N.m	1 to 50 mm ²	1.5 to 35 mm ²	16 to 50 mm ²	Ø 5 mm	3 x 16 mm ²	3 x 10 mm ²
Vigi C120	10 to 125 A	3.5 N.m	1 to 50 mm ²	1.5 to 35 mm ²	-	-	-	-

7	50 mm ² Al terminal	27060
8	Screw-on connection for ring terminal	27053
9	Multi-cable terminal	4 parts
		3 parts
10	Comb busbar	see module

Mounting accessories

11	Sealable terminal shield for connection from above and below	1P (set of 2)	18526
12	Interpole barrier	(set of 10)	27001
13	Screw shield	4P (set of 2)	18527
14	Clip-on terminal markers	see module	CM907003F
15	2, 3 and 4-pole label holder on toggle	16 parts	27150
16	9 mm spacer		27062
17	Padlocking device		27145
18	Plug-in base ⁽¹⁾		26996
		Rotary handle	27047
		Removable handle	
19	Fixed handle		27048
		Operating sub-assembly only ⁽²⁾	27046

(1) For 1P, centreline between 2 rows = 200 mm
(2) A complete rotary handle consists of a circuit-breaker operating sub-assembly, cat. no. 27046, a handle, cat. no. 27047 or a handle, cat. no. 27048.

Electrical auxiliaries

Indication		
3	SD fault indicating auxiliary contact	26927
4	OF open/closed auxiliary contact	26924
5	OF/SD+OF auxiliary contact (OF+SD or OF+OF combination)	26929
6	Tm C120 remote control	18312



Trip units		
2	MN, MNx, MN [Ⓜ] undervoltage release or MSU voltage threshold release MX + OF shunt release	see module CM907002F



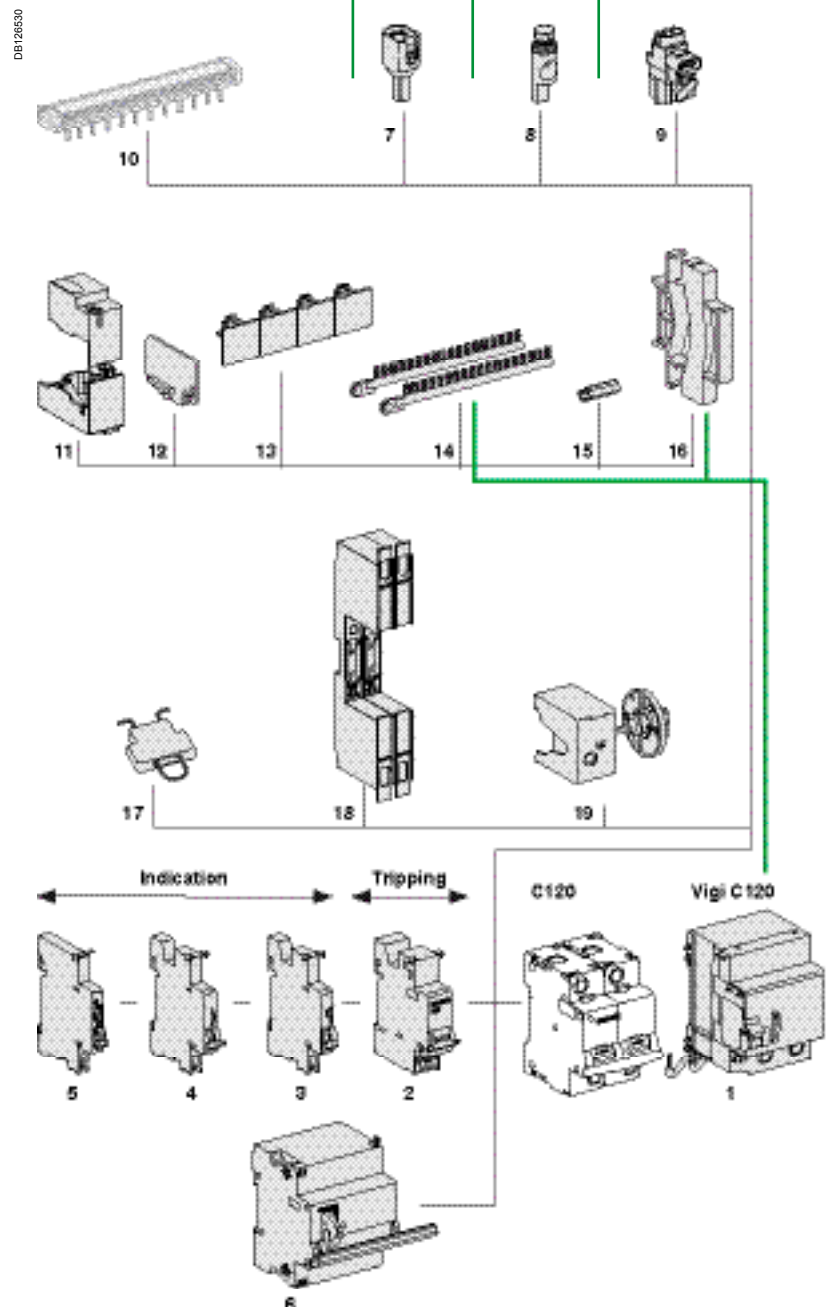

Vigi C120

1	Vigi C120 add-on residual current device	see module CM902007F
---	--	----------------------



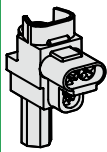
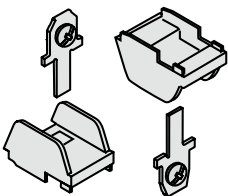

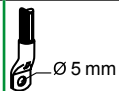

The trip units must be installed first.

Installation						
Accessories	Rotary handle			Plug-in base	Padlocking device	
						
Function						
	Front or side control of 2, 3 and 4-pole circuit breakers <ul style="list-style-type: none"> ■ Degree of protection: IP 40, IK 10 ■ Installation: <ul style="list-style-type: none"> □ the circuit-breaker operating sub-assembly cat. no. 27046 is fixed to the circuit breaker □ the removable handle cat. no. 27047 is mounted on the removable front panel or on the enclosure door □ the fixed handle cat. no. 27048 is fixed to the front or side panel of the enclosure ■ A complete rotary handle consists of: <ul style="list-style-type: none"> □ a circuit-breaker operating sub-assembly, cat. no. 27046, □ a handle cat. no. 27047 or a handle cat. no. 27048 			Allows a circuit breaker or switch to be quickly removed or replaced, without touching the connections <ul style="list-style-type: none"> ■ Degree of protection: IP20 ■ It consists of: <ul style="list-style-type: none"> □ a base to be fixed to a rail (or panel) □ 2 "blades" to be fixed in the device terminals ■ Connection: tunnel terminals for cables up to 50 mm² (rigid) or 35 mm² (flexible) ■ Installation: <ul style="list-style-type: none"> □ in a universal enclosure □ on a horizontal rail ■ Centreline between two rows: 200 mm ■ Only on the circuit breaker, without a Vigi device or auxiliary ■ Padlocking option (8 mm dia. padlock not supplied) 		Used to padlock a circuit breaker or a switch in the "open" or "closed" position <ul style="list-style-type: none"> ■ Diameter of the padlock: 8 mm max. ■ Locking in the ON position does not prevent the circuit breaker or switch from tripping in the event of a fault ■ Isolation: in conformity with IEC/EN 60947-2.
Catalogue numbers	27047 Removable extended handle	27048 Fixed handle	27046 Operating sub-assembly ⁽¹⁾	26996 (1 per pole)	27145	
Set of	1	1	1	1	1	
Suitable for the following devices:						
C120	■ 2P, 3P, 4P			■	■	
C120 + Vigi C120	■ 2P, 3P, 4P			-	■	

Connection				
Accessories	Multi-cable terminal		50 mm ² Al terminal	Screw-on connection for ring terminal
				
Function				
	For 3 copper cables: <ul style="list-style-type: none"> ■ Rigid up to 16 mm² ■ Flexible up to 10 mm² 		For 16 to 50 mm² aluminium cables	For cable end with ring terminal, front or rear mounting
				
Cat. numbers	19091	19096	27060	27053
Set of	4	3	1	8
C120	-	-	-	■
Vigi C120	-	-	-	-
Tightening torque	3.5 N.m		3.5 N.m	2 N.m
Stripping length	11 mm		13 mm	-
Tools to be used	Diameter 6 mm or PZ2		Hc 1/5" or 6.5 mm	Diameter 5 mm

(1) A complete rotary handle consists of a circuit-breaker operating sub-assembly, cat. no. **27046**, a handle cat. no. **27047** or a handle cat. no. **27048**.

Safety

Accessories	Screw shield	Terminal shield	Interpole barrier	Spacer
				
Function	<p>Prevents all contact with the fixing screws</p> <ul style="list-style-type: none"> ■ The degree of protection becomes IP40. ■ Sealable. ■ Dividable. 	<p>Prevents all contact with the terminals</p> <ul style="list-style-type: none"> ■ Degree of protection IP40 ■ Sealable, max. diameter 1.2 mm 	<p>Improves the insulation between the connections: cables, terminals, lugs, etc.</p>	<ul style="list-style-type: none"> ■ Used to: <ul style="list-style-type: none"> □ complete the rows □ separate the devices ■ Width: 1 x 9 mm module. ■ Allows cables to be routed from one row to another (above and below), up to 6 mm².
Catalogue numbers	18527	15526	27001	27062
Set of	2 (4P dividable)	2 (for upstream and downstream terminal)	10	1
Suitable for the following devices:				
C120	–	■	■	■
Vigi C120	–	–	–	■

Identification

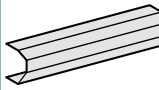
Accessories	Clip-on terminal marker strip	Label holder
		
For connection identification		
Catalogue numbers	<p>0 : AB1-R0 1 : AB1-R1 2 : AB1-R2 3 : AB1-R3 4 : AB1-R4 5 : AB1-R5 6 : AB1-R6 7 : AB1-R7 8 : AB1-R8 9 : AB1-R9</p> <p>A : AB1-GA B : AB1-GB C : AB1-GC D : AB1-GD E : AB1-GE F : AB1-GF G : AB1-GG H : AB1-GH I : AB1-GI J : AB1-GJ</p> <p>K : AB1-GK L : AB1-GL M : AB1-GM N : AB1-GN O : AB1-GO P : AB1-GP Q : AB1-GQ R : AB1-GR S : AB1-GS T : AB1-GT</p> <p>U : AB1-GU V : AB1-GV W : AB1-GW X : AB1-GX Y : AB1-GY Z : AB1-GZ + : AB1-R12 - : AB1-R13 Blank : AB1-RV</p>	27150
Set of	250	10
C120	■ 4 markers max. per pole	
Vigi C120	■ 4 markers max. per device	

Protection
Circuit protection
Earth leakage protection

Electrical auxiliaries for C60, C120, DPN, DPN Vigi, RCCB/ID, I-NA devices

- The electrical auxiliaries provide the remote tripping or position (open/closed/tripped) indication functions of these devices in the event of a fault.
- They clip on (no tool required) to the left-hand side of the associated device.
- The OF+SD/OF auxiliary is a two-in-one product: a mechanical selector switch is used to select one of two contacts: OF+SD or OF+OF.

IEC/EN 60947-1

- Tripping auxiliaries:
 - MN: undervoltage release
 - MNs: delayed undervoltage release
 - MNx: undervoltage release, independent of the supply voltage
 - MSU: voltage threshold release
 - MX: shunt release
 - MX+OF: shunt release with open/closed contact.

IEC/EN 60947-5-1

- Indication auxiliaries:
 - OF: open/closed contact
 - OF.S: open/closed contact for RCCB/ID
 - SD: fault indicating contact
 - OF+SD/OF: choice of open/closed contact and OF or SD contact via the selector switch.

⚠ The electrical auxiliaries are not compatible with ID residual current circuit breakers of type B.

DB123814

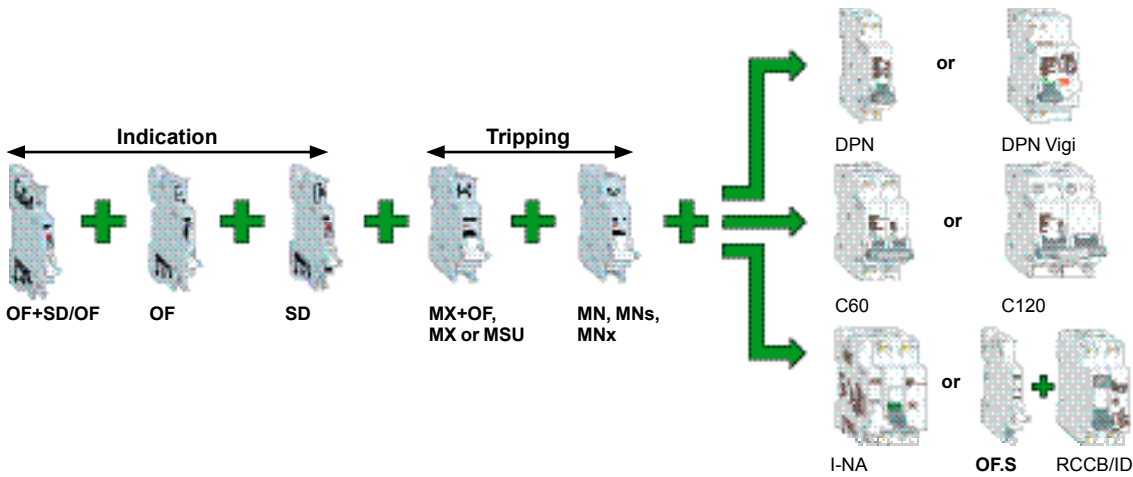

Combination table

Electrical auxiliaries		Devices
Indication	Tripping	
Maximum number of indication auxiliaries (from left to right)	Maximum number of tripping auxiliaries	
3 x OF or SD	+ 2 x MX or MN	<p>DPN, DPN Vigi C60, C120</p>
Or 2 x OF+SD/OF or OF or SD	2 x MX or MN	
Or none	3 x MSU	
2 x OF	2 x MX or MN or MSU	<p>I-NA OF.S+RCCB/ID</p>
1 x OF+SD/OF	2 x MX or MN or MSU	

The trip units must be installed first.



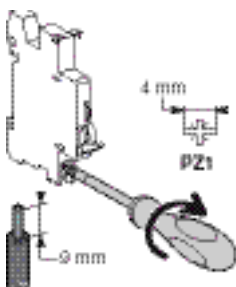

Connection

DB12361475



Type	Tightening torque	Copper cables	
		Rigid	Flexible
Indication and tripping auxiliaries	1 N.m	<p>DB122845</p> <p>0.5 to 2.5 mm²</p>	<p>DB122846</p> <p>2 x 1.5 mm²</p>

Electrical auxiliaries for C60, C120, DPN, DPN Vigi, RCCB/ID, I-NA devices (cont.)

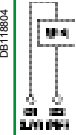
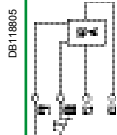
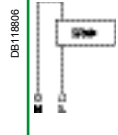
		Tripping									
Auxiliaries		MN		MNs		MNx		MSU			
Type		Undervoltage release									
		Instantaneous		Delayed		Independent of the supply voltage		Voltage threshold release			
											
Function		<ul style="list-style-type: none"> Causes the device with which it is associated to trip when its input voltage decreases (between 70 % and 35 % of Un). Prevents the device from closing until its input voltage has been restored 				<ul style="list-style-type: none"> Cuts off the power supply by opening the device with which it is associated when the phase/neutral voltage is exceeded (loss of neutral). For a four-phase network, use three MSU tripping auxiliaries 					
		<ul style="list-style-type: none"> No tripping in the event of transient voltage dips (up to 0.2 s) 		<ul style="list-style-type: none"> Separate input and power supply 		<ul style="list-style-type: none"> Tripping volt.: 275 V AC 		<ul style="list-style-type: none"> Tripping volt.: 255 V AC 			
Wiring diagrams											
Utilization		<ul style="list-style-type: none"> Emergency stop via a normally-closed pushbutton Ensures the safety of the power supply circuits of several machines by preventing accidental startups 				<ul style="list-style-type: none"> Fail-safe emergency stop Insensitive to the variation in the control circuit voltage to improve continuity of service 		<ul style="list-style-type: none"> Protection of the devices against overvoltages on the electrical network (break in the neutral conductor) Monitoring the voltage between the phase conductor and the neutral conductor 			
Catalogue numbers		26960	26961	26959	26963	26969	26977*	26971	26991*	26979	26479
Technical specifications											
Rated voltage (Ue)	V AC	220...240	48	115	220...240	230	400	230	230		
	V DC	–	48	–	–	–	–	–	–		
Operating frequency	Hz	50/60	400	50/60	50/60	50/60	–	50/60	–		
Mechanical state indicator light, red		On front face			On front face	On front face	–	On front face	–		
Test function		–			–	–	–	–	–		
Width in 9 mm modules		2			2	2	–	2	–		
Operating current		–			–	–	–	–	–		
Number of contacts		–			–	–	–	–	–		
Operating temperature	°C	-25...+50			-25...+50	-25...+50	–	-25...+50	–		
Storage temperature	°C	-40...+85			-40...+85	-40...+85	–	-40...+85	–		
Standards											
IEC/EN 60947-1		■			■	■	–	■	–		
IEC/EN 60947-5-1		–			–	–	–	–	–		
EN 60947-2		■			■	■	–	■	–		
EN 62019-2 ⁽¹⁾		–			–	–	–	–	–		

(*) Tripping auxiliaries MNx ref. 26977 and 26991 are specific for C60 circuit breakers.

(1) For C60, C120, iDPN (DPN).

Electrical auxiliaries for C60, C120, DPN, DPN Vigi, RCCB/ID, I-NA devices (cont.)

							Signalisation			
MX		MX+OF		OF.S	OF	SD	OF+SD/OF			
Shunt release		With open/closed auxiliary contact		Open/closed auxiliary contact	Open/closed auxiliary contact	Fault indicating contact	Double open/closed or fault indicating contact			
■ Trips the associated device when it is powered on		■ Includes an open/closed contact (OF contact) to indicate the "open" or "closed" position of the associated device		■ Changeover contact indicating the "open" or "closed" position of the associated device 	■ Changeover contact indicating the "open" or "closed" position of the associated device	■ Changeover contact indicating the position of the associated device in the event of: <input type="checkbox"/> electrical fault <input type="checkbox"/> action on the tripping auxiliary	■ The OF+SD/OF auxiliary is a two-in-one product: choice of OF + SD or OF + OF contact via the selector switch			
■ Emergency stop via a normally-open pushbutton.		■ Emergency stop via a normally-open pushbutton ■ Remote indication of the position of the associated device		■ Remote indication of the position of the associated device 	■ Remote indication of the position of the associated device	■ Remote fault tripping indication of the associated device	■ Remote position and/or fault tripping indication of the associated device			
26476	26477	26478	26946	26947	26948	26923	26924	26927	26929	
100...415	48	12...24	100...415	48	12...24	240...415	240...415	240...415	240...415	
110...130	48	12...24	110...130	48	12...24	24...130	24...130	24...130	24...130	
50/60		50/60		50/60		50/60	50/60	50/60	50/60	
On front face		On front face		-		-	On front face	On front face	On front face	
-		-		-		1	On front face	On front face	On front face	
2		2		-		1	1	1	1	
-		3 A / 415 V AC 6 A / ≤ 240 V AC		-		3 A / 415 V AC 6 A / ≤ 240 V AC	-	-	-	
-		1 NO/NC		-		1 NO/NC	1 NO/NC	1 NO/NC	1 NO/NC + 1 NO/NC	
-25...+50		-25...+50		-		-25...+50	-25...+50	-25...+50	-25...+50	
-40...+85		-40...+85		-		-40...+85	-40...+85	-40...+85	-40...+85	
■		■		-		-	-	-	-	
-		-		■		■	■	■	■	
-		-		-		-	-	-	-	
-		-		■		■	■	■	■	



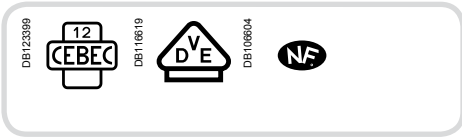

EN 61095, IEC 1095

iCT contactors are available in two versions:

- Contactors without manually-operated
- Contactors with manually-operated.

The breadth of the iCT contactor range satisfies most application cases.
iCT contactors can be combined with auxiliary control, protection and indication functions.

Contactors

iCT 2P
PB106115-35



manual control

iCT 4P
PB106105-35



- iCT contactors can be used to remote control applications in alternative networks:
 - lighting, heating, ventilation, roller blinds, sanitary hot water
 - mechanical ventilation systems, etc
 - load-shedding of non-priority circuits

PB106120-34



Indication iACTs

- This auxiliary allows indication or control of the "open" or "closed" position of the contactor power contacts

PB106124-34



Interference filtering iACTp

- This auxiliary is an interference suppressor which limits overvoltages on the control circuit

PB106123-34



Dual control iACTc

- Used to control a contactor in impulse-type mode or to combine latched or impulse-type control orders

PB106126-34



Time delay iATEt

- This auxiliary is used to time delay for iCT and iTL. According to cabling, there are 5 possible time delay types:
 - 1 for iTL
 - 4 for iCT

Function type A: late closing
Delay energizing of contactor

Function type B: time delay

- Energize the contactor by closing a push button
- The time delay starts as soon as the control contacts are closed

Function type C: late opening

- Energize the contactor by closing a push button
- The time delay starts when the control contacts are opened

Function type H: fixed time operation

- Operate the contactor for a pre-determined time from the moment of energizing

Contactors

Contactors auxiliaries

		Choice of 50 Hz contactors					
Type		Contactor					
Rating	A	16	20	25	40	63	100
Auxiliaries							
iACTs indication auxiliary		Yes	Yes	Yes			
iACTp protection auxiliary	By yellow clips	No	No	Yes			
iACTc, iATEt control auxiliary	By yellow clips	No	No	Yes			

PB10611E-39

Yellow clip

- A simple clip-on system for flexible auxiliaries combination and improved robustness
- For electrical and mechanical connections

Insulated terminals IP20

Minimum noise

Mechanical contact position indicator

Manually-operated contactors have a 4-position selector switch on their front face:

- automatic operating mode
- temporary "ON" override
- permanent "ON" override: used to lock the contactor in the ON position during installation maintenance
- shutdown

Consistent with the entire Acti9 offer and with all types of lighting

Large circuit labeling area

Consistent with the entire Acti9 offer and with all types of lighting

					Choice of 60 Hz contactors				
Manually-operated contactors					Contactor				Manually-operated contactors
16	25	40	63		16	25	40	63	40
Contactors that can be equipped with auxiliaries					Contactors that can be equipped with auxiliaries				
Yes					Yes				
Yes	Yes				Yes	Yes			
No	Yes				No	Yes			

Catalogue numbers

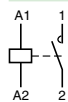
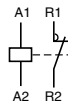
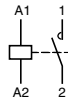
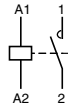
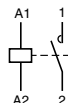
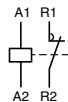
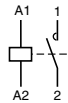
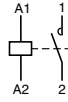
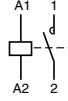
iCT contactors - 50 Hz							
Type						Width in 9 mm modules	
1P							
	16 A	6 A	12	1NO	A9C22011	2	
			24	1NO	A9C22111	2	
	48		1NO	A9C22211	2		
	220		1NO	A9C22511	2		
	230...240		1NO	A9C22711	2		
	25 A		8.5 A	220	1NO	A9C20531	2
230...240	1NO	A9C20731	2				
2P							
	16 A	6 A	12	2NO	A9C22012	2	
			24	2NO	A9C22112	2	
			48	2NO	A9C22212	2	
			220	2NO	A9C22512	2	
			230...240	2NO	A9C22712	2	
	16 A	6 A	12	1NO+1NC	A9C22015	2	
			24	1NO+1NC	A9C22115	2	
			220	1NO+1NC	A9C22515	2	
			230...240	1NO+1NC	A9C22715	2	
	20 A	6 A	230...240	2NO	A9C22722	2	
			25 A	8.5 A	24	2NO	A9C20132
	48				2NO	A9C20232	2
	220				2NO	A9C20532	2
	230...240				2NO	A9C20732	2
	220				2NC	A9C20536	2
	230...240		2NC	A9C20736	2		
40 A	15 A	220...240	2NO	A9C20842	4		
63 A	20 A	24	2NO	A9C20162	4		
		220...240	2NO	A9C20862	4		
100 A	-	220...240	2NO	A9C20882	6		
3P							
	16 A	6 A	220...240	3NO	A9C22813	4	
	25 A	8.5 A	220...240	3NO	A9C20833	4	
	40 A	15 A	220...240	3NO	A9C20843	6	
	63 A	20 A	220...240	3NO	A9C20863	6	
4P							
	16 A	6 A	24	4NO	A9C22114	4	
			220...240	4NO	A9C22814	4	
			220...240	2NO+2NC	A9C22818	4	
	20 A	6 A	220...240	4NO	A9C22824	4	
			25 A	8.5 A	24	4NO	A9C20134
	220...240				4NO	A9C20834	4
	24		4NC	A9C20137	4		
	40 A	15 A	220...240	4NO	A9C20837	4	
			63 A	20 A	220...240	2NO+2NC	A9C20838
	220...240				4NO	A9C20844	6
	220...240		4NC	A9C20847	6		
	100 A	-	24	4NO	A9C20164	6	
			220...240	4NO	A9C20864	6	
			24	4NC	A9C20167	6	
			220...240	4NC	A9C20867	6	
			220...240	2NO+2NC	A9C20868	6	
220...240	3NO+1NC	A9C20869	6				
220...240	4NO	A9C20884	12				

Catalogue numbers

iCT manual control contactor 50 Hz									
Type	Rating (In)		Control voltage (V AC) (50 Hz)	Contact		Width in 9 mm modules			
	AC7a	AC7b							
<p>DB108317-24</p>	16 A	6 A	220	2NO	A9C23512	2			
			230...240	2NO	A9C23712	2			
			220	1NO+1NC	A9C23515	2			
			230...240	1NO+1NC	A9C23715	2			
	25 A	8.5 A	24	2NO	A9C21132	2			
			24	2NC	A9C21136	2			
			220	2NO	A9C21532	2			
			230...240	2NO	A9C21732	2			
	40 A	15 A	24	2NO	A9C21142	2			
			220...240	2NO	A9C21842	4			
			63 A	20 A	24	2NO	A9C21162	4	
					220...240	2NO	A9C21862	4	
<p>DB106319-27</p>	25 A	8.5 A	220...240	3NO	A9C21833	4			
			40 A	15 A	220...240	3NO	A9C21843	6	
	<p>DB108320-31</p>	25 A	8.5 A	24	4NO	A9C21134	4		
				24	4NC	A9C21137	4		
220...240				4NO	A9C21834	4			
40 A				15 A	24	4NO	A9C21144	6	
		24	4NC		A9C21147	6			
		220...240	4NO		A9C21844	6			
		63 A	20 A		24	4NO	A9C21164	6	
220...240				4NO	A9C21864	6			
<p>DB106657-36</p>				25 A	8.5 A	24	4NO	A9C21134	4
						24	4NC	A9C21137	4
		220...240	4NO			A9C21834	4		
		40 A	15 A			24	4NO	A9C21144	6
24	4NC			A9C21147	6				
220...240	4NO			A9C21844	6				
63 A	20 A			24	4NO	A9C21164	6		
		220...240	4NO	A9C21864	6				

Catalogue numbers

ICT contactors - 60 Hz							
Type						Width in 9 mm modules	
	1P Rating (In) AC7a	AC7b	Control voltage (V AC) (60 Hz)	Contact			
					25 A	8.5 A	127
			220...240	1NO	A9C20631	2	
	2P Rating (In) AC7a	AC7b	Control voltage (V AC) (60 Hz)	Contact			
					16 A	6 A	127
				220...240	1NO+1NC	A9C22615	2
		25 A	8.5 A	127	2NO	A9C20432	2
				220...240	2NO	A9C20632	2
				127	2NC	A9C20436	2
			220...240	2NC	A9C20636	2	
	Rating (In) AC7a	AC7b	Control voltage (V AC) (60 Hz)	Contact			
					40 A	15 A	127
			220...240	2NO	A9C20642	4	
	3P Rating (In) AC7a	AC7b	Control voltage (V AC) (60 Hz)	Contact			
					25 A	8.5 A	127
				220...240	3NO	A9C20633	4
		40 A	15 A	127	3NO	A9C20443	6
				220...240	3NO	A9C20643	6
	63 A	20 A	127	3NO	A9C20463	6	
			220...240	3NO	A9C20663	6	





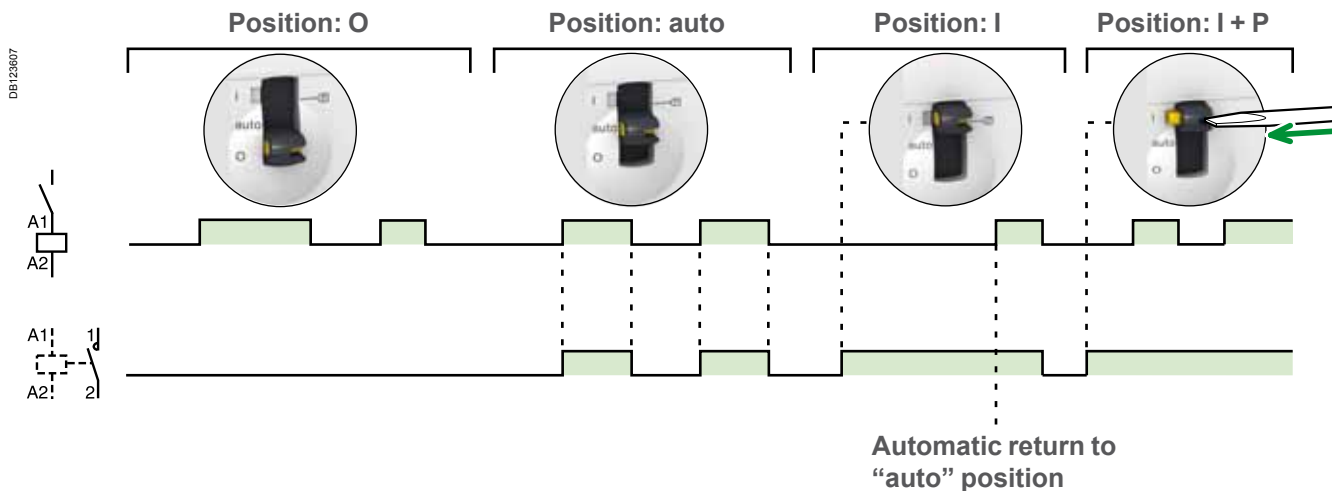

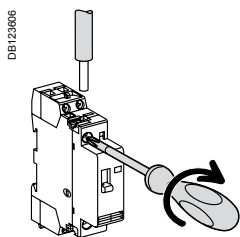

ICT manual control contactor 60 Hz						
Type						Width in 9 mm modules
	2P Rating (In) AC7a	AC7b	Control voltage (V AC) (60 Hz)	Contact		
					40 A	15 A
			220...240	2NO	A9C21642	4

Operation (Manual control contactor)



Connection



Type	Rating	Length tripping	Circuit	Tightening torque	Copper cables		
					Rigid	Flexible or ferrule	
iCT	PZ1: 4 mm	16 - 100 A	9 mm	Control	0.8 N.m		
		16 and 25 A		Power			
	PZ2: 6 mm	40 A - 63 A	14 mm		3.5 N.m		
		100 A					
iACTs, iACTp, iACTc, iATEt	PZ1: 4 mm	-	9 mm	-	0.8 N.m		

DE122945

DE122946

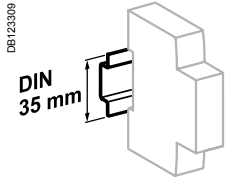

Clip on DIN rail 35 mm.

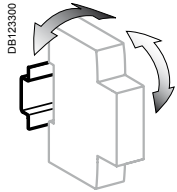

± 30° vertical.

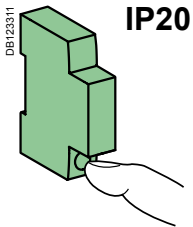

IP20

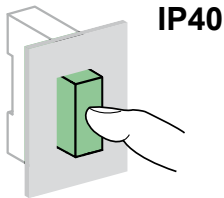

IP40

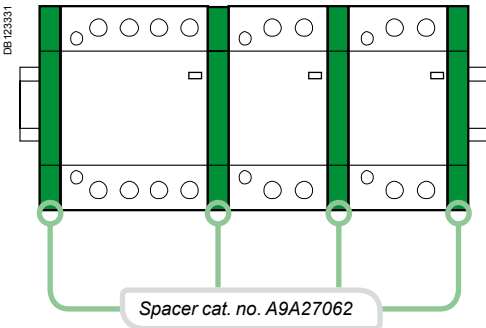

Technical data

Power circuit		
Voltage rating (Ue)	1P, 2P	250 V AC
	3P, 4P	400 V AC
Frequency	50 Hz or 60 Hz	
Type of load	See module CA908026	
Endurance (O-C)		
Electrical	100,000 cycles	
Maximum number of switching operation a day	100	
Additional characteristics		
Insulation voltage (Ui)	500 V AC	
Pollution degree	2	
Rated impulse withstand voltage (Uimp)	2.5 kV (4 kV for 12/24/48 V AC)	
Degree of protection (IEC 60529)	Device only	IP20
	Device in modular enclosure	IP40
Operating temperature	-5°C to +60°C ⁽¹⁾	
Storage temperature	-40°C to +70°C	
Tropicalization (IEC 60068-1)	Treatment 2 (relative humidity 95 % at 55°C)	
ELSV compliance (Extra Low Safety Voltage) for 12/24/48 V AC versions		
The product control conforms to the SELV (safety extra low voltage) requirements		

(1) In the case of contactor mounting in a enclosure for which the interior temperature is in range between 50°C and 60°C, it is necessary to use a spacer, cat. no. A9A27062, between each contactor

Mounting accessories

6	Sealable screw shields for top and bottom	3P, 4P 25 A	A9A15921
		2P 40/63 A	A9A15922
		3P, 4P 40/63 A	A9A15923
7	9 mm spacer		A9A27062
8	Yellow clips		A9C15415

DB123698

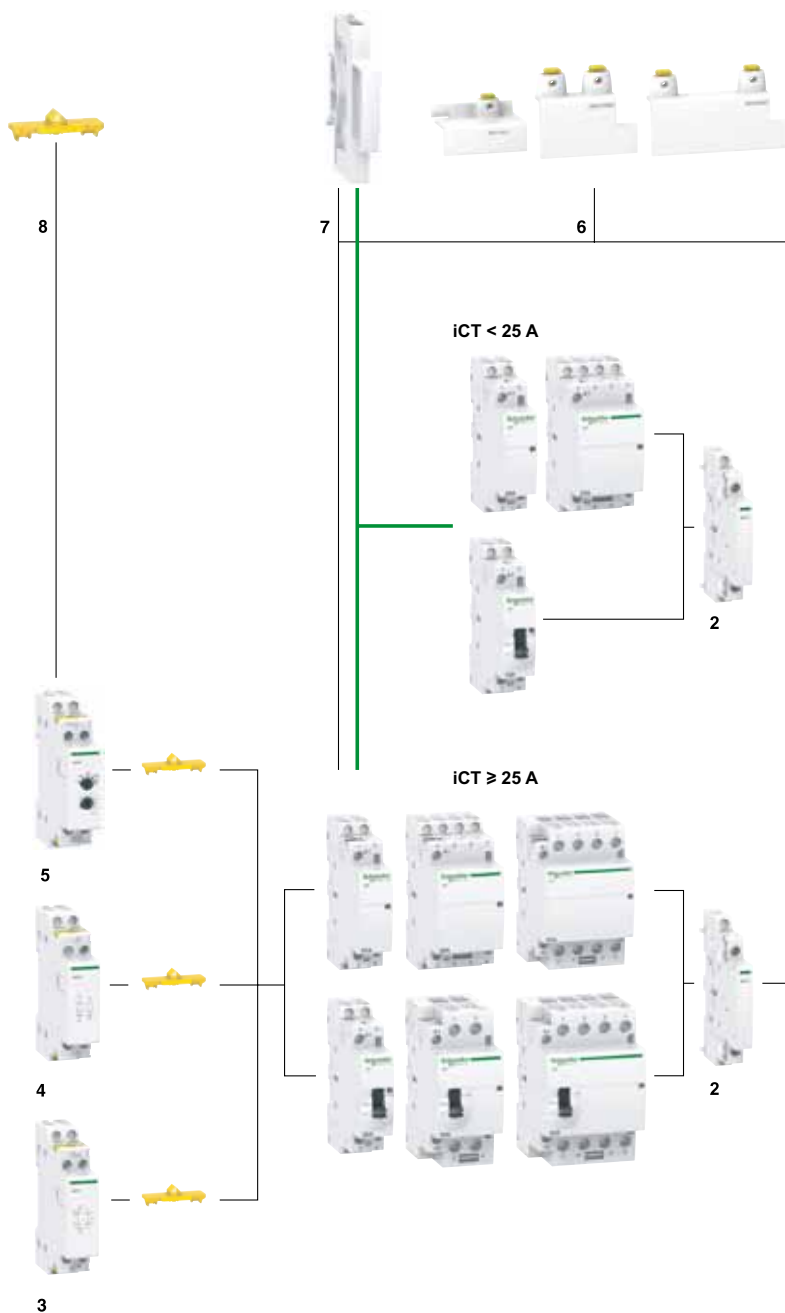

Auxiliaries

Indication			
2	iACTs	1NO + 1NC	A9C15914
		1CO	A9C15915
		2NO	A9C15916
Double control inputs			
3	iACTc	230 V AC	A9C18308
		24 V AC	A9C18309
Coil suppression blocs			
4	iACTp	12...48 V AC	A9C15919
		48...127 V AC	A9C15918
		220...240 V AC	A9C15920
Time delay			
5	iATEt	24...240 V AC	A9C15419



iCT contactors

Electrical auxiliaries for iCT

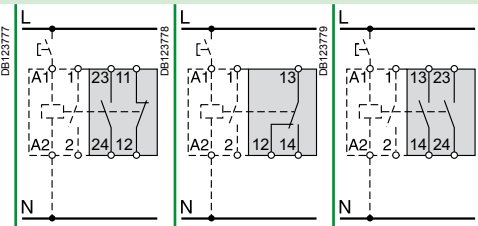
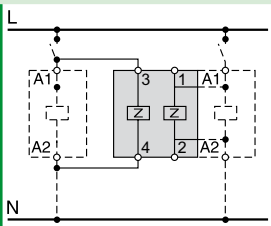
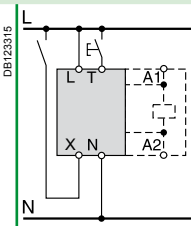
	Indication			Protection			Control																																																																																						
Auxiliaries	iACTs			iACTp			iACTc																																																																																						
Type	Indication			Interference filtering			Impulse/latched control																																																																																						
	With Open/Close auxiliary contact			2 protection circuits			Impulse/latched control																																																																																						
																																																																																													
Function	<ul style="list-style-type: none"> This auxiliary allows indication of the "open" or "closed" position of the contactor power contacts 			<ul style="list-style-type: none"> This auxiliary is an interference suppressor which limits overvoltages on the control circuit 			<ul style="list-style-type: none"> This auxiliary, combined with contactors, enables them to be controlled by 2 order types: <ul style="list-style-type: none"> impulse order for local control (input T) latched order for centralised control (input X) the last order received takes priority 																																																																																						
Wiring diagrams																																																																																													
Mounting	<ul style="list-style-type: none"> Mounted to the right of iCT 			<ul style="list-style-type: none"> Mounted to the left of iCT by yellow clips⁽¹⁾ By wires 			<ul style="list-style-type: none"> Mounted to the left of iCT by yellow clips⁽¹⁾ 																																																																																						
Use	-			<ul style="list-style-type: none"> The iACTp has 2 separate and identical circuits, allowing it to be combined with 2 different one on the iCT the other by wires 			<ul style="list-style-type: none"> Mains power outages: <ul style="list-style-type: none"> < 1 s: keeps its initial status ≥ 5 s: reset put back into operation by manual operation on input X or T. Minimum impulse duration: 250 ms 																																																																																						
Catalogue numbers	A9C15914	A9C15915	A9C15916	A9C15918	A9C15919	A9C15920	A9C18308	A9C18309																																																																																					
Technical specifications	<table border="1"> <tr> <td rowspan="2">Control voltage (Ue)</td> <td>V AC</td> <td colspan="3">24...240</td> <td>48...127</td> <td>12...48</td> <td>220...240</td> <td>230...240</td> <td>24...48</td> </tr> <tr> <td>V DC</td> <td colspan="3">24...130</td> <td colspan="2">-</td> <td colspan="3">-</td> </tr> <tr> <td rowspan="2">Operating frequency</td> <td>Hz</td> <td colspan="3">50/60</td> <td colspan="3">50/60</td> <td colspan="2">50/60</td> </tr> <tr> <td>Width in 9 mm modules</td> <td colspan="3">1</td> <td colspan="3">2</td> <td colspan="2">2</td> </tr> <tr> <td rowspan="3">Auxiliary contact (breaking capacity)</td> <td colspan="9"> <ul style="list-style-type: none"> Minimum: 10 mA at 24 V DC/AC - cos φ = 1 Maximum: <ul style="list-style-type: none"> 5 A at 240 V AC - cos φ = 1 1 A at 130 V DC </td> </tr> <tr> <td>Number of contacts</td> <td>1NO + 1NC</td> <td>1CO</td> <td>2NO</td> <td colspan="3">-</td> <td colspan="2">-</td> </tr> <tr> <td>Operating temperature</td> <td>°C</td> <td colspan="7">-5°C to +50°C</td> </tr> <tr> <td>Storage temperature</td> <td>°C</td> <td colspan="7">-40°C to +70°C</td> </tr> <tr> <td>Consumption</td> <td></td> <td colspan="5">-</td> <td colspan="3"> OFF load: 3 VA Inrush⁽²⁾: 2 VA Holding⁽²⁾: 0.2 VA </td> </tr> </table>								Control voltage (Ue)	V AC	24...240			48...127	12...48	220...240	230...240	24...48	V DC	24...130			-		-			Operating frequency	Hz	50/60			50/60			50/60		Width in 9 mm modules	1			2			2		Auxiliary contact (breaking capacity)	<ul style="list-style-type: none"> Minimum: 10 mA at 24 V DC/AC - cos φ = 1 Maximum: <ul style="list-style-type: none"> 5 A at 240 V AC - cos φ = 1 1 A at 130 V DC 									Number of contacts	1NO + 1NC	1CO	2NO	-			-		Operating temperature	°C	-5°C to +50°C							Storage temperature	°C	-40°C to +70°C							Consumption		-					OFF load: 3 VA Inrush ⁽²⁾ : 2 VA Holding ⁽²⁾ : 0.2 VA		
Control voltage (Ue)	V AC	24...240			48...127	12...48	220...240	230...240		24...48																																																																																			
	V DC	24...130			-		-																																																																																						
Operating frequency	Hz	50/60			50/60			50/60																																																																																					
	Width in 9 mm modules	1			2			2																																																																																					
Auxiliary contact (breaking capacity)	<ul style="list-style-type: none"> Minimum: 10 mA at 24 V DC/AC - cos φ = 1 Maximum: <ul style="list-style-type: none"> 5 A at 240 V AC - cos φ = 1 1 A at 130 V DC 																																																																																												
	Number of contacts	1NO + 1NC	1CO	2NO	-			-																																																																																					
	Operating temperature	°C	-5°C to +50°C																																																																																										
Storage temperature	°C	-40°C to +70°C																																																																																											
Consumption		-					OFF load: 3 VA Inrush ⁽²⁾ : 2 VA Holding ⁽²⁾ : 0.2 VA																																																																																						
<p>(1) Electrical and mechanical link. (2) Maximum consumption of all contactors controlled.</p>																																																																																													

iCT contactors

Electrical auxiliaries for iCT (cont.)

Control (cont.)

iATEt

Time delay

PB106125-34



- This auxiliary is used to time delay for iCT and iTL. According to cabling, there are 5 possible time delay types:
- 1 for iTL
- 4 for iCT.

Function type A: late closing

- Delay energizing of contactor.

Function type B: time delay

- Energize the contactor by closing a push button.
- The time delay starts as soon as the control contacts are closed.

Function type C: late opening

- Energize the contactor by closing a push button.
- The time delay starts when the control contacts are opened.

Function type H: fixed time operation

- Operate the contactor for a pre-determined time from the moment of energizing.

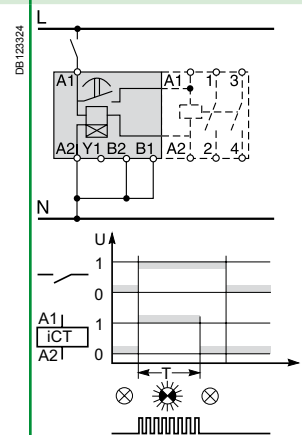
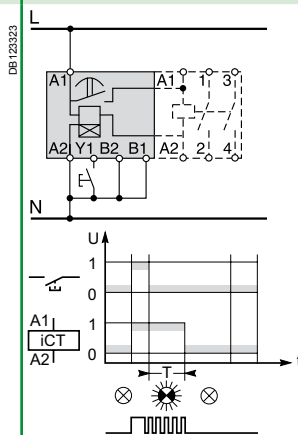
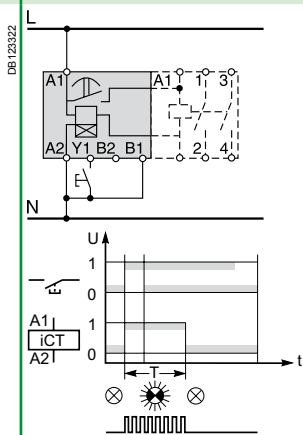
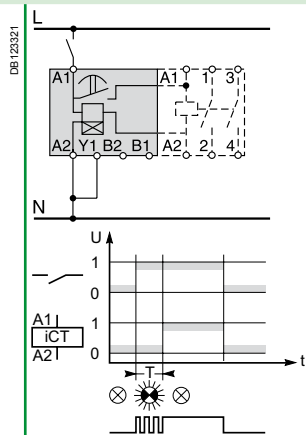

- Mounted to the left of iCT by yellow clips⁽¹⁾

A9C15419

24...240

24...110





50/60

2

-20°C to +50°C

-40°C to +80°C

Off-load: 5 VA
Inrush⁽²⁾: 3 A
Holding⁽²⁾: 0.2 A

Security					
Accessories	Sealable screw shields			Yellow clips	Spacer
 PE104485-15	 PE104486-15	 PE104487-15	 PE106143-10	 PE104483-40	
Function					
<ul style="list-style-type: none"> ■ Designed to cover terminals to avoid contact with device screws. ■ Allow sealing 			<ul style="list-style-type: none"> ■ Ensure the mechanical and/or electrical link between contactors and their auxiliaries. 		
<ul style="list-style-type: none"> ■ For iCT: 3P, 4P - 25 A 	<ul style="list-style-type: none"> ■ For iCT: 2P - 40/63 A 	<ul style="list-style-type: none"> ■ For iCT: 3P, 4P - 40/63 A 	<ul style="list-style-type: none"> ■ Required to reduce temperature rise of modular devices installed side by side. ■ Recommended to separate electronic devices (thermostat, programmable clock, etc.) from electromechanical devices (relays, contactors). 		
Use					
<ul style="list-style-type: none"> ■ Bag of 10 upstream/10 downstream 			<ul style="list-style-type: none"> ■ Bag of 10 	<ul style="list-style-type: none"> ■ Bag of 5 	
Catalogue numbers	A9A15921	A9A15922	A9A15923	A9C15415	A9A27062
Technical specifications					
Width in 9 mm modules	4	4	6	–	1
Number of poles	3P, 4P	2P	3P	–	–

iCT contactors

Technical advice for iCT

Consumption

iCT contactors - 50 Hz											
Type											
1P	Rating (In)		Control voltage (V AC) (50 Hz)	Consumption		Max. power					
	AC7a	AC7b		Holding	Inrush						
16 A	5 A		12	3.8 VA	15 VA	1.3 W	A9C22011				
			24	3.8 VA	15 VA	1.3 W	A9C22111				
			48	3.8 VA	15 VA	1.3 W	A9C22211				
			220	3.8 VA	15 VA	1.3 W	A9C22511				
			230...240	2.7 VA	9.2 VA	1.2 W	A9C22711				
	25 A	8.5 A		220	3.8 VA	15 VA	1.3 W	A9C20531			
				230...240	2.7 VA	9.2 VA	1.2 W	A9C20731			
				2P							
				16 A	5 A		12	3.8 VA	15 VA	1.3 W	A9C22012
							24	3.8 VA	15 VA	1.3 W	A9C22112
48	3.8 VA	15 VA	1.3 W				A9C22212				
220	3.8 VA	15 VA	1.3 W				A9C22512				
230...240	2.7 VA	9.2 VA	1.2 W				A9C22712				
12	3.8 VA	15 VA	1.3 W				A9C22015				
24	3.8 VA	15 VA	1.3 W				A9C22115				
220	3.8 VA	15 VA	1.3 W				A9C22515				
20 A	6.4 A		230...240	2.7 VA	9.2 VA	1.2 W	A9C22722				
			25 A	8.5 A		24	3.8 VA	15 VA	1.3 W	A9C20132	
48	3.8 VA	15 VA	1.3 W			A9C20232					
220	3.8 VA	15 VA	1.3 W			A9C20532					
230...240	2.7 VA	9.2 VA	1.2 W			A9C20732					
220	3.8 VA	15 VA	1.3 W			A9C20536					
230...240	2.7 VA	9.2 VA	1.2 W	A9C20736							
40 A	15 A		220...240	4.6 VA	34 VA	1.6 W	A9C20842				
63 A	20 A		24	4.6 VA	34 VA	1.6 W	A9C20162				
			220...240	4.6 VA	34 VA	1.6 W	A9C20862				
100 A	-		220...240	6.5 VA	53 VA	2.1 W	A9C20882				
3P											
16 A	5 A		220...240	4.6 VA	34 VA	1.6 W	A9C22813				
25 A	8.5 A		220...240	4.6 VA	34 VA	1.6 W	A9C20833				
40 A	15 A		220...240	6.5 VA	53 VA	2.1 W	A9C20843				
63 A	20 A		220...240	6.5 VA	53 VA	2.1 W	A9C20863				
4P											
16 A	5 A		24	4.6 VA	34 VA	1.6 W	A9C22114				
			220...240	4.6 VA	34 VA	1.6 W	A9C22814				
			220...240	4.6 VA	34 VA	1.6 W	A9C22818				
20 A	6.4 A		220...240	4.6 VA	34 VA	1.6 W	A9C22824				
25 A	8.5 A		24	4.6 VA	34 VA	1.6 W	A9C20134				
			220...240	4.6 VA	34 VA	1.6 W	A9C20834				
			24	4.6 VA	34 VA	1.6 W	A9C20137				
			220...240	4.6 VA	34 VA	1.6 W	A9C20837				
			220...240	4.6 VA	34 VA	1.6 W	A9C20838				
40 A	15 A		220...240	6.5 VA	53 VA	2.1 W	A9C20844				
			220...240	6.5 VA	53 VA	2.1 W	A9C20847				
63 A	20 A		24	6.5 VA	53 VA	2.1 W	A9C20164				
			220...240	6.5 VA	53 VA	2.1 W	A9C20864				
			24	6.5 VA	53 VA	2.1 W	A9C20167				
			220...240	6.5 VA	53 VA	2.1 W	A9C20867				
			220...240	6.5 VA	53 VA	2.1 W	A9C20868				
			220...240	6.5 VA	53 VA	2.1 W	A9C20869				
100 A	-		220...240	13 VA	106 VA	4.2 W	A9C20884				

Consumption (cont.)

iCT manual control contactor 50 Hz							
Type							
2P	Rating (In)		Control voltage (V AC) (50 Hz)	Consumption		Max. power	
	AC7a	AC7b		Holding	Inrush		
16 A	5 A	220	2.7 VA	9.2 VA	1.2 W	A9C23512	
		230...240	2.7 VA	9.2 VA	1.2 W	A9C23712	
		220	3.8 VA	15 VA	1.3 W	A9C23515	
		230...240	2.7 VA	9.2 VA	1.2 W	A9C23715	
25 A	8.5 A	24	3.8 VA	15 VA	1.3 W	A9C21132	
		24	3.8 VA	15 VA	1.3 W	A9C21136	
		220	2.7 VA	9.2 VA	1.2 W	A9C21532	
		230...240	2.7 VA	9.2 VA	1.2 W	A9C21732	
40 A	15 A	24	4.6 VA	34 VA	1.6 W	A9C21142	
		220...240	4.6 VA	34 VA	1.6 W	A9C21842	
63 A	20 A	24	4.6 VA	34 VA	1.6 W	A9C21162	
		220...240	4.6 VA	34 VA	1.6 W	A9C21862	
3P							
25 A	8.5 A	220...240	4.6 VA	34 VA	1.6 W	A9C21833	
40 A	15 A	220...240	6.5 VA	53 VA	2.1 W	A9C21843	
4P							
25 A	8.5 A	24	4.6 VA	34 VA	1.6 W	A9C21134	
		24	4.6 VA	34 VA	1.6 W	A9C21137	
		220...240	4.6 VA	34 VA	1.6 W	A9C21834	
40 A	15 A	24	6.5 VA	53 VA	2.1 W	A9C21144	
		24	6.5 VA	53 VA	2.1 W	A9C21147	
		220...240	6.5 VA	53 VA	2.1 W	A9C21844	
63 A	20 A	24	6.5 VA	53 VA	2.1 W	A9C21164	
		220...240	6.5 VA	53 VA	2.1 W	A9C21864	

iCT contactors - 60 Hz							
Type							
1P	Rating (In)		Control voltage (V AC) (60 Hz)	Consumption		Max. power	
	AC7a	AC7b		Holding	Inrush		
25 A	8.5 A	127	3.8 VA	15 VA	1.3 W	A9C20431	
		220 ...240	2.7 VA	9.2 VA	0.9 W	A9C20631	
2P							
16 A	5 A	127	3.8 VA	15 VA	1.3 W	A9C22415	
		220...240	2.7 VA	9.2 VA	0.9 W	A9C22615	
25 A	8.5 A	127	3.8 VA	15 VA	1.3 W	A9C20432	
		220...240	2.7 VA	9.2 VA	0.9 W	A9C20632	
		127	3.8 VA	15 VA	1.3 W	A9C20436	
		220...240	2.7 VA	9.2 VA	0.9 W	A9C20636	
40 A	15 A	127	4.6 VA	34 VA	1.6 W	A9C20442	
		220...240	4.6 VA	34 VA	1.6 W	A9C20642	
3P							
25 A	8.5 A	127	4.6 VA	34 VA	1.6 W	A9C20433	
		220...240	4.6 VA	34 VA	1.6 W	A9C20633	
40 A	15 A	127	6.5 VA	53 VA	2.1 W	A9C20443	
		220...240	6.5 VA	53 VA	2.1 W	A9C20643	
63 A	20 A	127	6.5 VA	53 VA	2.1 W	A9C20463	
		220...240	6.5 VA	53 VA	2.1 W	A9C20663	

Dimensions (mm)

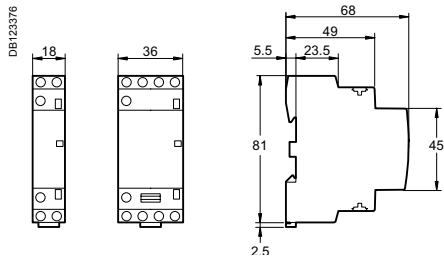

iCT 16/25 A

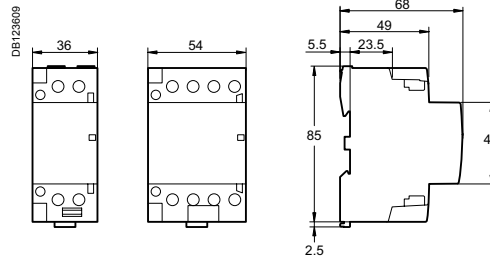

iCT 40/63 A

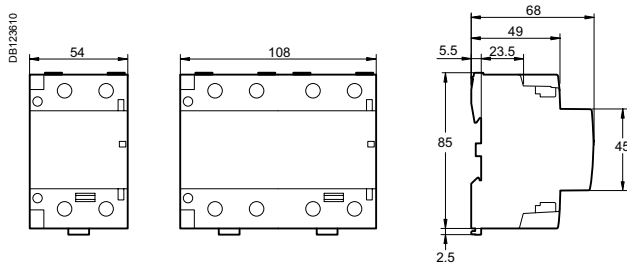

iCT 100 A

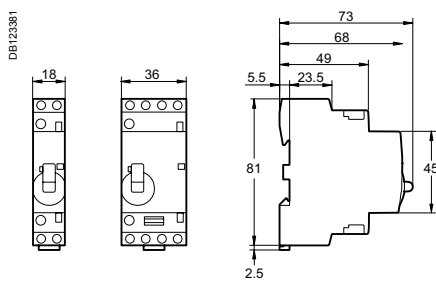

iCT manual control contactor 16/25 A

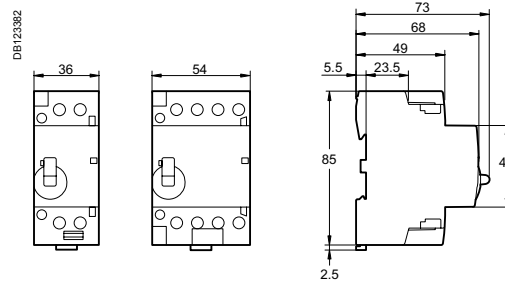

iCT manual control contactor 40/63 A

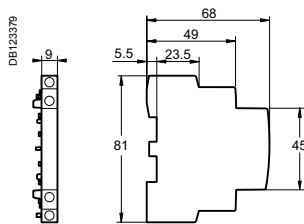

iACTs

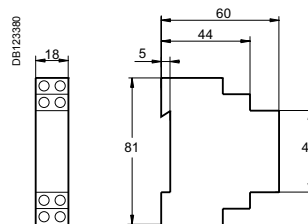

iATEt
iACTp
iACTc



IEC/EN 60669-2-2
iTLs: IEC/EN 60947-5-1

Impulse relays



iTL
 ■ The impulse relays are used to control, by means of pushbuttons, lighting circuits consisting of:
 □ incandescent lamps, low-voltage halogen lamps, etc. (resistive loads)
 □ fluorescent lamps, discharge lamps, etc. (inductive loads)

Remote indication



iTLs
 ■ Allows remote indication of its operating state (open/closed)



Indication iATLs
 ■ Allows remote indication of the associated impulse relay

Centralised control



iTLc
 ■ Allows centralised control of a group of TLc impulse relays, whilst at the same time retaining local impulse-type control



Centralised control iATLc
 ■ Used for centralised control, thanks to a "pilot line", of a group of impulse relays controlling separate circuit, while at the same time maintaining local individual control of each impulse relay

Latched control



iTLm
 ■ Operated by latched orders from a changeover contact (switch, time switch, thermostat). Manual control does not work



Latched control iATLm
 ■ Controls the associated impulse relay by latched orders from a changeover contact

Impulse relays

Impulse relays are used:

- Closing of the impulse relay pole(s) is triggered by an impulse on the coil.
- Having two stable mechanical positions, the pole(s) will be opened by the next impulse. Each impulse received by the coil reverses the position of the pole(s).
- Can be controlled by an unlimited number of pushbuttons.
- Zero energy consumption.

PB106131-34



Changeover contact iTLi

- This impulse relay has a changeover contact

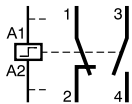

PB106134-34



Extensions iETL

- Used to increase the number of impulse relay poles
- Can be installed on the iTL, iTLi, iTLc, iTLm and iTLs

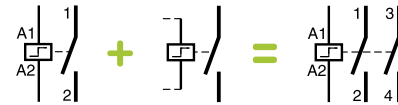

PB106140-34



Centralised control + indication iATLc+s

- Used for centralised control, thanks to a "pilot line", of a group of impulse relays controlling separate circuit, while at the same time maintaining local individual control of each impulse relay
- Remote indication of the mechanical status of each relay

PB106136-34



Multi-level centralised control iATLc+c

- Allows centralised control of a group of iTLc or "iTL + ATLc" impulse relays

PB106125-34



Time delay iATEt

- Combined with an impulse relay, it automatically disconnects the circuit after a preset time

PB106141-34



Control iATLz

- Must be used when installing several illuminated PBs in parallel to control an impulse relay (prevents operating malfunctions)

PB106142-63



Step by step control iATL4

- Allows step-by-step control of two circuits via a single pushbutton

Mounting accessories

10	Yellow clips	A9C15415
11	9 mm spacer	A9A27062
12	Clip-on terminal markers	see module CA907001

DB123631

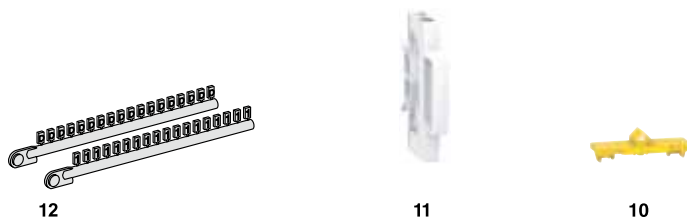

Auxiliaries

Centralised control			
2	iATLc ^{(1),(3)}	24...240 V AC	A9C15404
Indication			
3	iATLs ⁽¹⁾	24...240 V AC	A9C15405
Centralised control + indication			
4	iATLc+s ⁽³⁾	24...240 V AC	A9C15409
Multi-level centralised control			
5	iATLc+c ^{(2),(3)}	24...240 V AC	A9C15410
Step by step control			
6	iATL4	230 V AC	A9C15412
Control by illuminated push-buttons			
7	iATLz	130...240 V AC	A9C15413
Latched control			
8	iATLm ⁽¹⁾	12...240 V AC	A9C15414
Time delay control			
9	iATEt ⁽⁴⁾	24...240 V AC	A9C15419

(1) The iATLc, iATLs and iATLm 9 mm auxiliaries are used by themselves to the right of an impulse relay.

(2) Connection by traditional cabling. The iATLc+c must be mounted to the right of an iATLc+s or an iATLc.

(3) The centralised control functions (iTLc, iATLc, iATLc+s, iATLc+c) only operate on AC voltage networks.

(4) iATEt: control voltage: 24...240 V AC, 24...110 V DC.

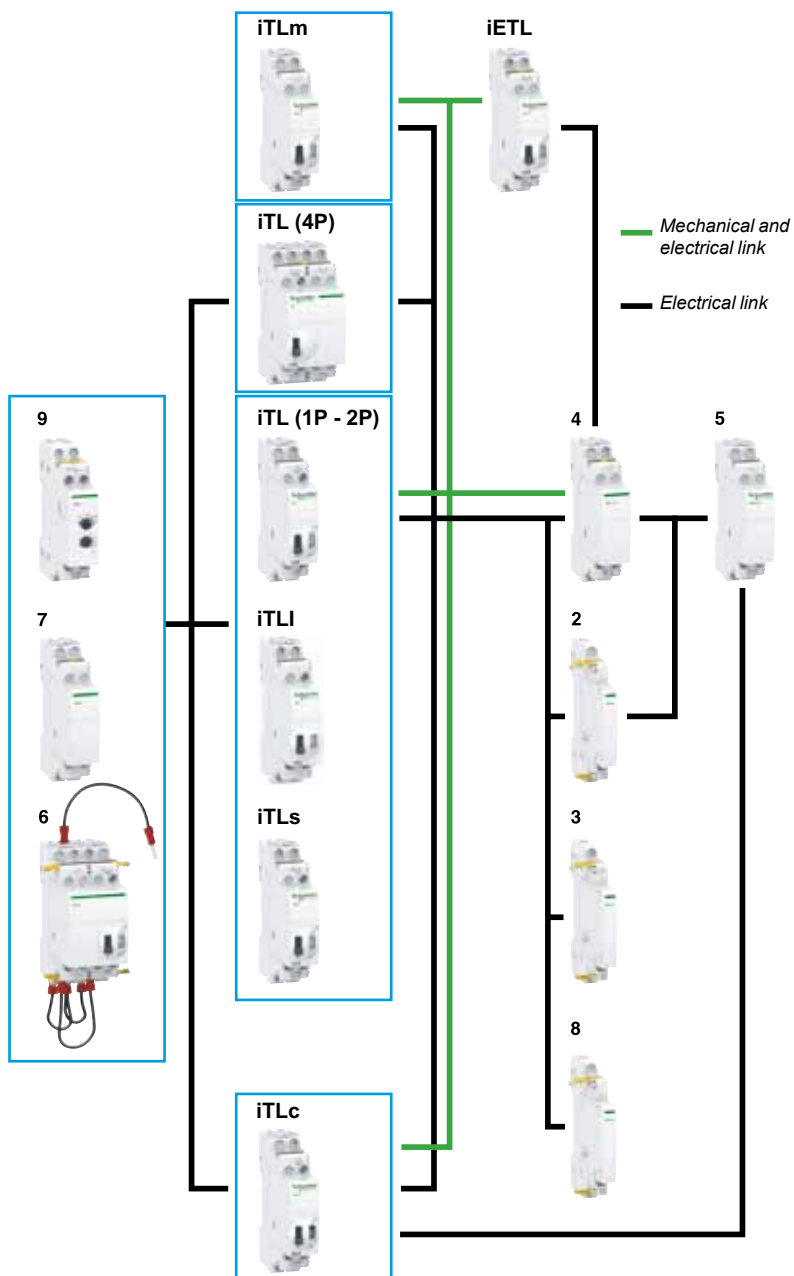

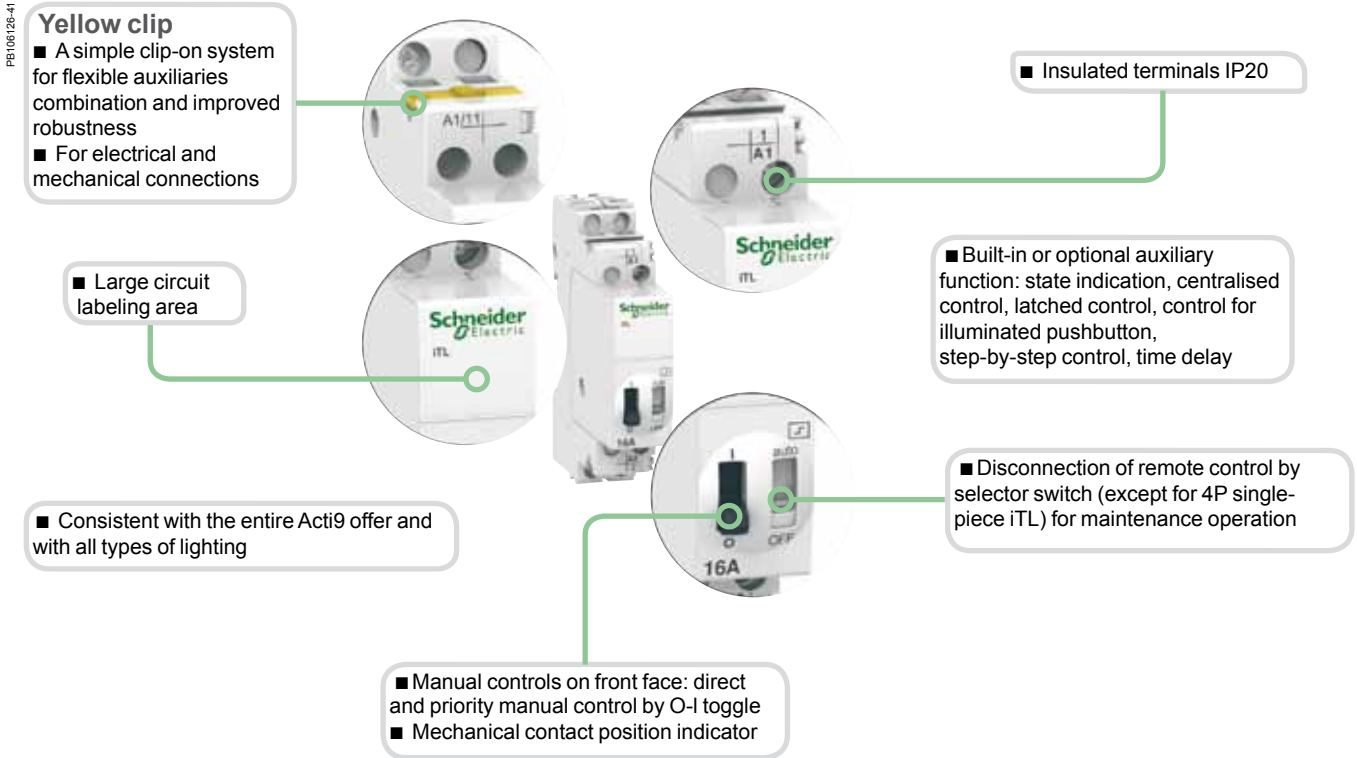

		Choice impulse relays auxiliaries																	
Type		Standard iTL					Changeover iTLI					iTLc centralised control			iTLm control on latched order		iTLs remote indication		
Rating	A	16	32	16	16	16	16	16	16	16	16	16	16	16	16	16			
Control voltage	V AC	230/240	130 48 24 12	230/240	230/240	130 48 24 12	230/240	130 48 24 12	230/240	130 48 24 12	230/240	48 24	230/240	230/240	48 24	230/240			
	V DC	110	48 24 12 6	110	110	48 24 12 6	-	-	-	-	110	110	110	110	110	110			
Auxiliaries																			
Extension																			
iETL		■	■	■	■	■	■	■	■	■	■	■	■	■	■	■			
Centralised control + indication																			
iATLc+s		■	■	■	■	-	■	■	■	■	-	-	-	-	-	■	■	■	
Centralised control																			
iATLc		■	■	■	■	-	■	■	■	■	-	-	-	-	-	■	■	■	
Indication																			
iATLs		■	■	■	■	-	■	■	■	■	■	■	■	■	■	■	■	■	
Multi-level centralised control																			
iATLc+c		■	■	■	■	-	■	■	■	■	-	-	■	■	■	-	■	■	■
Latched control																			
iATLm		■	■	■	■	■	■	■	■	■	■	■	-	-	-	-	■	■	■
Control for illuminated Pushbutton																			
iATLz		■	■	-	-	-	■	■	■	-	-	-	■	■	-	-	■	■	-
Step by step control																			
iATL4		■	-	-	-	-	■	■	-	-	-	-	■	-	-	-	■	-	-
Time delay control																			
iATEt		■	■	■	(*)	■	-	■	■	■	■	■	(*)	-	■	■	■	■	(*)

(*) iATEt : does not operate on 12 V DC.

Catalogue numbers

iTL impulse relays

Type			1P	2P	3P	4P
Rating (In)	Control voltage (Uc)					
	(V AC)	(V DC)				
16 A	12	6	A9C30011	A9C30012	A9C30011 + A9C32016	A9C30012 + A9C32016
	24	12	A9C30111	A9C30112	A9C30111 + A9C32116	A9C30114
	48	24	A9C30211	A9C30212	A9C30211 + A9C32216	A9C30212 + A9C32216
	130	48	A9C30311	A9C30312	A9C30311 + A9C32316	A9C30312 + A9C32316
	230...240	110	A9C30811	A9C30812	A9C30811 + A9C32816	A9C30814
32 A	230...240	110	A9C30831	A9C30831 + A9C32836	A9C30831 + 2 x A9C32836	A9C30831 + 3 x A9C32836
Width in 9 mm modules			2	2	4	4

iTL impulse relays

Type			1P
Rating (In)	Control voltage (Uc)		
	(V AC)	(V DC)	
16 A	12	6	A9C30015
	24	12	A9C30115
	48	24	A9C30215
	130	48	A9C30315
	230...240	110	A9C30815
Width in 9 mm modules			2

iETL extensions for iTL and iTLI

Type					Width in 9 mm modules
1P	Rating (In)	Control voltage (Uc)			
		(V AC)	(V DC)		
	32 A	230...240	110	A9C32836	2
2P	Rating (In)	Control voltage (Uc)			
	16 A	12	6	A9C32016	2
		24	12	A9C32116	2
		48	24	A9C32216	2
		130	48	A9C32316	2
		230...240	110	A9C32816	2

iTLC, iTLm, iTLs with built-in auxiliary function

Catalogue numbers (cont.)

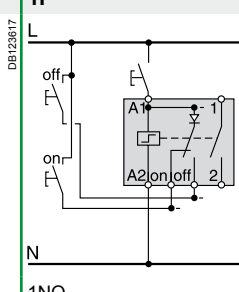
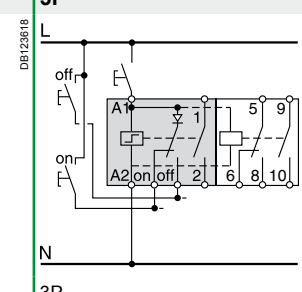
iTLC impulse relay with centralised control		1P	3P
Type			
Rating (In)	Control voltage (Uc) (V AC)		
16 A	24	A9C33111	A9C33111 + A9C32116
	48	A9C33211	A9C33211 + A9C32216
	230...240	A9C33811	A9C33811 + A9C32816
Width in 9 mm modules		2	4

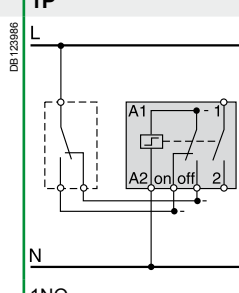
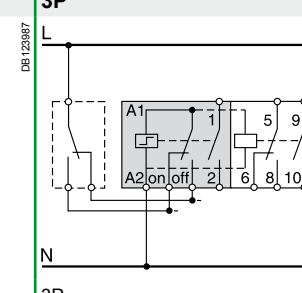
iTLm impulse relay with latched control		1P	3P
Type			
Rating (In)	Control voltage (Uc) (V AC)		
16 A	230...240	A9C34811	A9C34811 + A9C32116
Width in 9 mm modules		2	4

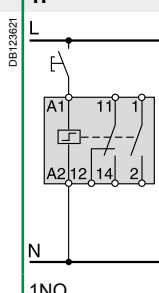
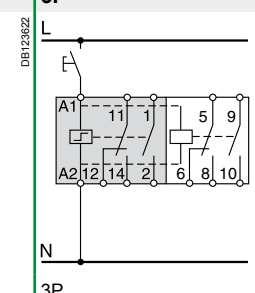
iTLs impulse relay with remote indication*		1P	3P
Type			
Rating (In)	Control voltage (Uc) (V AC) (V DC)		
16 A	24 12	A9C32111	A9C32111 + A9C32116
	48 24	A9C32211	A9C32211 + A9C32216
	230...240 110	A9C32811	A9C32811 + A9C32816
Width in 9 mm modules		2	4

(*) Short circuit protection device for indication contacts : 6 A gG fuse.

Operation

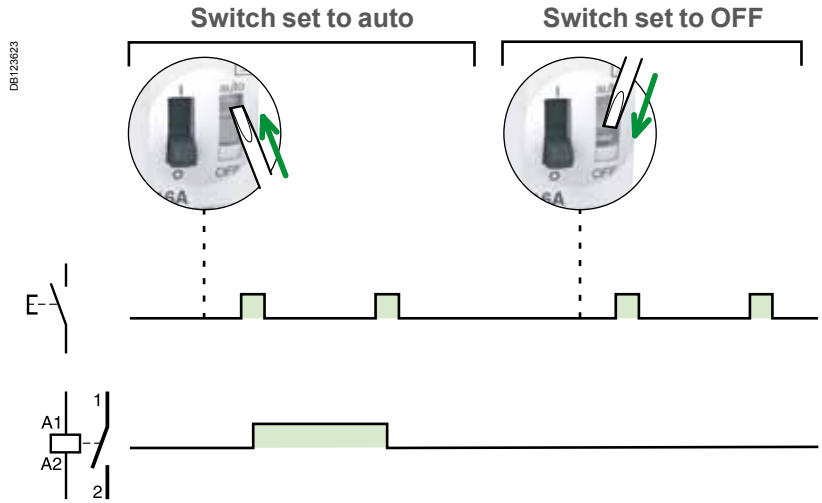

Connection

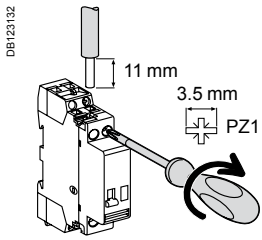

Type	Rating	Circuit	Tightening torque	Copper cables	
				Rigid or ferrule	Flexible or ferrule
iTL, iTLi, iTLc, iTLm, iTLs, iETL	16 A	Control	1 N.m		
		Power		0.5 to 4 mm ²	1 to 4 mm ²
iTL, iETL	32 A	Control	1.2 N.m	0.5 to 4 mm ²	1 to 4 mm ²
		Power		1.5 to 10 mm ²	1.5 to 10 mm ²
Auxiliaries			1 N.m	0.5 to 4 mm ²	1 to 4 mm ²

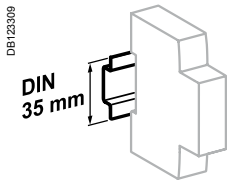

Clip on DIN rail 35 mm.

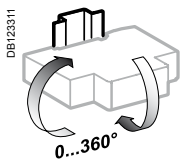

Indifferent position of installation.

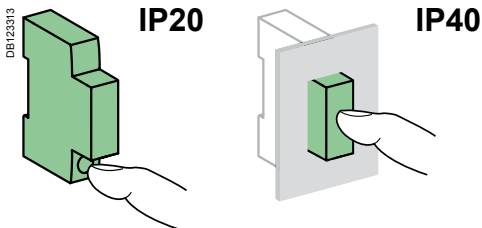





Technical data

Control circuit		
	iTL and iTLI 16 A iTLC, iTLm, iTLS, iETL 16 A	iTL 32 A, iETL 32 A
Dissipated power (during the impulse)	1, 2, 3P: 19 VA 4P: 38 VA	19 VA
Illuminated PB control	Max. current 3 mA (if > use an ATLz)	
Operating threshold	Min. 85 % of Un in conformance with IEC/EN60669-2-2	
Duration of the control order	50 ms to 1 s (200 ms recommended)	
Response time	50 ms	
Power circuit		
Voltage rating (Ue)	1P, 2P	24 ...250 V AC
	3P, 4P	24...415 V AC
Frequency	50 Hz or 60 Hz	
Maximum number of operations per minute	5	
Maximum number of switching operation a day	100	
Additional characteristics to IEC/EN 60947-3		
Insulation voltage (Ui)	440 V AC	
Pollution degree	3	
Rated impulse withstand voltage (Uimp)	6 kV	
Endurance (O-C)		
Electrical to IEC/EN 60947-3	200,000 cycles (AC21)	50,000 cycles (AC21)
	100,000 cycles (AC22)	20,000 cycles (AC22)
Overvoltage category	IV	
Other characteristics		
Degree of protection (IEC 60529)	Device only	IP20
	Device in modular enclosure	IP40 Insulation class II
Operating temperature	-20°C to +50°C	
Storage temperature	-40°C to +70°C	
Tropicalization (IEC 60068-1)	Treatment 2 (relative humidity 95 % at 55°C)	

iTL impulse relays

Electrical auxiliaries for iTL impulse relays

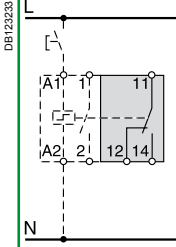
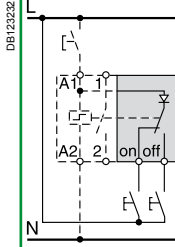
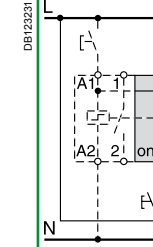
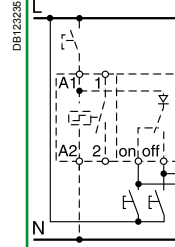
		Indication		Control	
Auxiliaries		iATLs		iATLc	
Type		Indication		Centralised control	
				Centralised control + indication	
				Multi-level centralised control	
					
Function		<ul style="list-style-type: none"> Allows remote indication of the associated impulse relay 	<ul style="list-style-type: none"> Used for centralised control, thanks to a "pilot line", of a group of impulse relays controlling separate networks, while at the same time maintaining local individual control of each impulse relay 	<ul style="list-style-type: none"> And for remote indication of the mechanical status of each relay 	<ul style="list-style-type: none"> Used to control the centralised controls of a number of impulse relay groups, while at the same time maintaining local individual control and centralised control by level
Wiring diagrams					
					
					<ul style="list-style-type: none"> Each group, made up of iATLc or (iTL or iTLI or iATLs) + iATLc+s, must only contain a single iATLc+c Maximum number of impulse relays that can be controlled: <ul style="list-style-type: none"> 230 V AC: 24 130 V AC: 12 48 V AC: 5
Mounting					
		<ul style="list-style-type: none"> Mounted to the right of iTL by yellow clips 	<ul style="list-style-type: none"> Mounted to the right of iTL by yellow clips 	<ul style="list-style-type: none"> Mounted to the right of iTL by yellow clips 	<ul style="list-style-type: none"> Without mechanical link with impulse relays and auxiliaries
Catalogue numbers		A9C15405	A9C15404	A9C15409	A9C15410
Technical specifications					
Control voltage (Ue)	V AC	24...240	24...240	24...240	24...240
	V DC	24...240	-	-	-
Width in 9 mm modules		1	1	2	2
Auxiliary contact (breaking capacity)		<ul style="list-style-type: none"> Minimum: 10 mA at 24 V AC/DC Maximum (IEC 60947-5-1): <ul style="list-style-type: none"> 12...240 V AC 6 A 12...24 V DC 6 A 15...240 V AC 2 A 13...24 V DC 2 A 		<ul style="list-style-type: none"> Minimum: 10 mA at 24 V AC/DC Maximum (IEC 60947-5-1): <ul style="list-style-type: none"> 12...240 V AC 6 A 12...24 V DC 6 A 15...240 V AC 2 A 13...24 V DC 2 A 	
Number of contacts		-	-	-	-
Operating temperature	°C	-20°C to +50°C			
Storage temperature	°C	-40°C to +70°C			

iTL impulse relays Electrical auxiliaries for iTL impulse relays (cont.)

Control

iATLm	iATEt	iATL4	iATLz
-------	-------	-------	-------

Latched control	Time delay	Step by step control	Control by illuminated push-buttons
-----------------	------------	----------------------	-------------------------------------



- | | | | |
|---|--|--|---|
| <ul style="list-style-type: none"> Combined with an impulse relay, it operates on latched orders | <ul style="list-style-type: none"> Combined with an impulse relay, it automatically disconnects the circuit after a preset time | <ul style="list-style-type: none"> Allows the step by step sequence over 2 circuits | <ul style="list-style-type: none"> Used to control impulse relays by illuminated push-buttons, without operating risks |
|---|--|--|---|

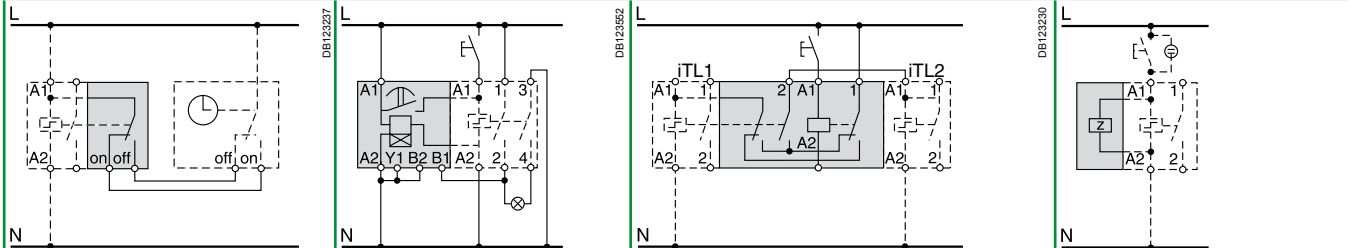

- | | | | |
|---|---|--|--|
| – | <ul style="list-style-type: none"> 5 time setting ranges: <ul style="list-style-type: none"> 1 to 10 s 6 to 60 s 2 to 10 min 6 to 60 min 2 to 10 h | <ul style="list-style-type: none"> The cycle is as follows: <ul style="list-style-type: none"> 1st impulse - iTL 1 closed, iTL 2 open 2nd impulse - iTL 1 open, iTL 2 closed 3rd impulse - iTL 1 and 2 closed 4th impulse - iTL 1 and 2 open 5th impulse - iTL 1 closed, iTL 2 open, etc | <ul style="list-style-type: none"> Provide an iATLz when the current drawn up by the illuminated push-buttons is higher than 3 mA (this current is sufficient to keep the coils energised). Above this value, fit one extra iATLz per 3 mA. For example: for 7 mA, fit 2 iATLz |
|---|---|--|--|

- | | | | |
|--|---|---|---|
| <ul style="list-style-type: none"> Mounted to the right of iTL by yellow clips <p>A9C15414</p> | <ul style="list-style-type: none"> Mounted to the left of iTL by yellow clips <p>A9C15419</p> | <ul style="list-style-type: none"> Assembled between 2 impulse relays: according to the auxiliarisation table by yellow clips <p>A9C15412</p> | <ul style="list-style-type: none"> Mounted to the left of iTL by yellow clips <p>A9C15413</p> |
|--|---|---|---|

12...240	24...240	230	130...240
6...110	24...110	–	–
1	2	4	2
–	–	–	–
–	–	–	–
–20°C to +50°C	–	–	–
–40°C to +70°C	–	–	–

Accessories	Security Yellow clips
	
Function	<ul style="list-style-type: none"> ■ Ensure the mechanical and/or electrical link between contactors and their auxiliaries (set of 10).
Catalogue numbers	A9C15415
Technical specifications	
Width in 9 mm modules	—
Number of poles	—

Dimensions (mm)

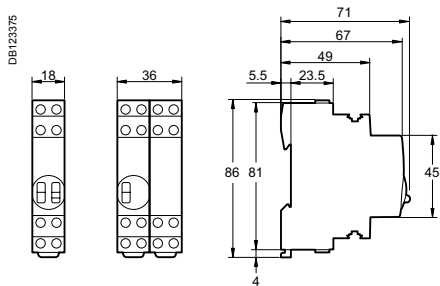

iTL 1P
iTLc
iTLm
iTLs
iTLi
iETL

iTL+iETL
iTL 4P

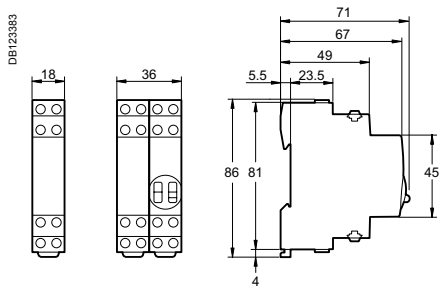

iATLc+s
iATLc+c
iATLz
iATL4

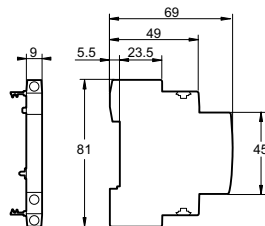

iATLc
iATLs
iATLm

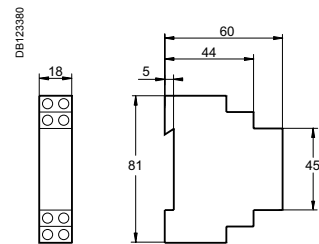

iATEt

IEC 60669-1 and IEC 60947-5-1

■ iPB pushbuttons are used to control electric circuits by means of pulses.

Catalogue numbers

iPB pushbuttons										
Type	Single				Double		Single + indicator light			
Diagram	1 NC 3 E-7 4		1 NO 1 E-7 2	1 NO + 1 NC 1 3 E-7 2 4	1 NO / 1 NC 1 3 E-7 2 4	1 NO / 1 NO 1 3 E-7 2 4	1 NO 1 X1 E-7 2 X2	1 NC 3 X1 E-7 4 X2	1 NO 1 X1- E-7 2 X2+	1 NC 3 X1- E-7 4 X2+
Pushbutton Colour	Grey	Red	Grey	Grey	Green/red	Grey/grey	Grey	Grey	Grey	Grey
Indicator light	Power supply	-	-	-	-	-	110...230 V AC		12...48 V AC/DC	
	Colour	-	-	-	-	-	Green	Red	Green	Red
Cat. no.	A9E18030	A9E18031	A9E18032	A9E18033	A9E18034	A9E18035	A9E18036	A9E18037	A9E18038	A9E18039
Width in 9 mm modules	2				2		2			

Connection

Tightening torque	Copper cables	
	Rigid	Flexible or ferrule
1 N.m	0.5 mm ² min. 2 x 2.5 mm ² max.	0.5 mm ² min. 2 x 2.5 mm ² max.

- Phase-separated wall that can be divided to allow the teeth of all types of comb busbar to pass through.
- Staggered terminals to simplify connection.

Dimensions (mm)

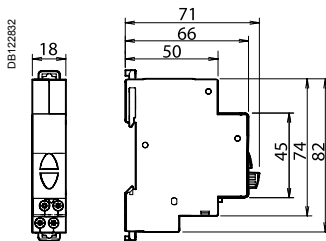



Technical data

Main characteristics	
Pollution degree	3
Power circuit	
Voltage rating (Ue)	250 V AC
Current rating (Ie)	20 A
Additional characteristics	
Endurance (O-C)	30,000 operations AC22 (cos j = 0.8)
Operating temperature	-35°C... +70°C
Storage temperature	-40°C... +80°C
Tropicalization	Treatment 2 (relative humidity 95 % at 55°C)
LED indicator light	Consumption: 0.3 W Service life: 100,000 hours of constant lighting efficiency Maintenance-free indicator light (non-interchangeable LEDs)

IEC 60669-1 and IEC 60947-5-1

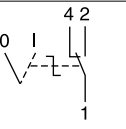
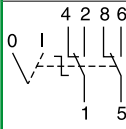
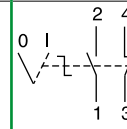
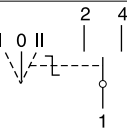
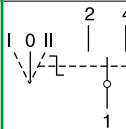

■ iSSW linear switches are used for the manual control of electric circuits.

Catalogue numbers

iSSW linear switches					
Type	2 positions			3 positions	
					
Contact	1 changeover switch	2 changeover switches	1 NO + 1NC	1 changeover switch	2 changeover switches
Diagram					
Cat. no.	A9E18070	A9E18071	A9E18072	A9E18073	A9E18074
Width in 9 mm modules	2	4	2	2	4

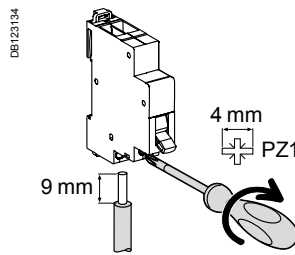
Connection



Tightening torque	Copper cables	
	Rigid	Flexible or ferrule
1 N.m	 0.5 mm ² min. 2 x 2.5 mm ² max.	 0.5 mm ² min. 2 x 2.5 mm ² max.

- Phase-separated wall that can be divided to allow the teeth of all types of comb busbar to pass through.
- Staggered terminals to simplify connection.

Dimensions (mm)

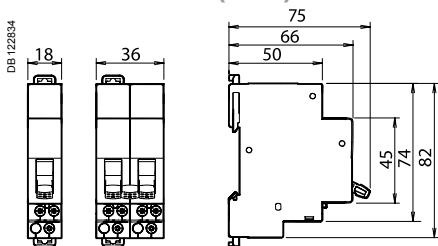

Technical data

Main characteristics	
Pollution degree	3
Power circuit	
Voltage rating (Ue)	250 V AC
Current rating (Ie)	20 A
Additional characteristics	
Endurance (O-C)	30,000 cycles AC22 (cos j = 0.8)
Operating temperature	-20°C... +50°C
Storage temperature	-40°C... +70°C
Tropicalization	Treatment 2 (relative humidity 95 % at 55°C)

Position contact indication

- Suitable for industrial isolation according to IEC/EN 60947-3 standard.
- The presence of the green strip guarantees physical opening of the contacts and allows operations to be performed on the downstream circuit in complete safety.



PB105266-40
DB122818



Control switches

PB105265-40

iSW control switches (20, 32 A)

- IEC/EN 60669-1, iSW switch with indicator light.
- IEC/EN 60669-2-4, iSW switch without indicator light.

These switches are used for:

- Control (opening and closing of circuits under load).
- The 1P and 2P switches are available with or without indicator light.
- Disconnection, for switches without indicator light IEC/EN 60669-2-4.

iSW switch-disconnectors (40 to 125 A)

IEC 60947-3

The switch-disconnectors combine the following functions:

- Control (opening and closing of circuits under load).





OF iSW auxiliary

- Mounted on the left, it indicates the "open" or "closed" position of the switch and has a normally open (NO) or normally closed (NC) contact.

Accessory

- The padlocking facility locks the switch in the "open" or "closed" position.

Catalogue numbers

20, 32 A iSW control switches				
Type	Rating	Voltage (Ue)		Width in 9 mm modules
 1P	20 A	250 V AC	A9S60120	2
	32 A	250 V AC	A9S60132	
 2P	20 A	250 V AC	-	2
		415 V AC	A9S60220	
	32 A	250 V AC	-	
		415 V AC	A9S60232	
 3P	20 A	415 V AC	A9S60320	4
	32 A	415 V AC	A9S60332	
 4P	20 A	415 V AC	A9S60420	4
	32 A	415 V AC	A9S60432	
Operating frequency			50/60 Hz	

PB 105266-40



Control switches with indicator light

Catalogue numbers (cont.)

20, 32 A iSW control switches with indicator light

Type			Width in 9 mm modules
1P 	Rating	230 V indicator light	2
	20 A	A9S61120	
	32 A	A9S61132	2
	2P		
	20 A	A9S61220	2
	32 A	A9S61232	
Operating frequency		50/60 Hz	

Spare indicator lights for 20, 32 A iSW switches

Type		
Neon	Voltage (Ue)	
Supplied with a red diffuser (Pack of 10)	230 V AC	15111
Incandescent bulb (P=1.2 W)		
Supplied with a red diffuser (Pack of 10)	12 V DC/AC	15112
	24 V DC/AC	15113
	48 V DC/AC	15114

PB 105266-40



Switch-disconnectors

PB 105267-40



40 to 125 A iSW switch-disconnectors

Type				Width in 9 mm modules		
1P 	Rating	Voltage (Ue)		2		
	40 A	250 V AC	A9S60140			
	63 A	250 V AC	A9S60163			
	100 A	250 V AC	A9S60191			
	125 A	250 V AC	A9S60192	2		
	2P					
		40 A	415 V AC		A9S60240	4
		63 A	415 V AC		A9S60263	
100 A		415 V AC	A9S60291			
125 A		415 V AC	A9S60292			
3P			6			
	40 A	415 V AC		A9S60340		
	63 A	415 V AC		A9S60363		
	100 A	415 V AC		A9S60391		
	125 A	415 V AC	A9S60392			
4P			8			
	40 A	415 V AC		A9S60440		
	63 A	415 V AC		A9S60463		
	100 A	415 V AC		A9S60491		
	125 A	415 V AC	A9S60492			
Operating frequency		50/60 Hz				

PE106264-40



OF iSW

Catalogue numbers (cont.)

Auxiliary				Width in 9 mm modules
Type				
OF iSW	Rating	Voltage (Ue)	A9A15096	2
	3 A	415 V AC		
	6 A	250 V AC		

DB122821

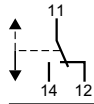

Accessories

Type	
Padlocking facility (for Ø 8 mm padlock)	
Pack of 2 parts	26970

Technical data

Main characteristics	20, 32 A iSW	40 to 125 A iSW
Insulation voltage (Ui)	Without indicator light ■ 1P: 250 V AC ■ 2P, 3P, 4P: 500 V AC	With indicator light 250 V AC 1P: 250 V AC 2P, 3P, 4P: 500 V AC
Pollution degree	2	3
Power circuit		
Rated impulse withstand voltage (Uimp)	4 kV	6 kV
Operating category	AC - 22 A	AC - 22 A
Permissible rated short-time withstand current (Icw)	-	40 A, 63 A: 1260 A 100 A, 125 A: 2500 A
Conditional rated short-circuit current (Inc)	3 kA to IEC/EN 60669-2-4	6 kA to IEC 60947-3
Rated short-circuit closing current (Icm)	-	40 A, 63 A: 4.2 kA 100 A, 125 A: 5 kA
Using direct current	48 V (110 V with 2 poles in series)	
Additional characteristics		
Degree of protection	IP40 on the front panel	
Endurance (O-C)	Mechanical	300,000 cycles
	Electrical	30,000 cycles
Operating temperature	40, 63 A iSW	20,000 cycles
	100 A iSW	10,000 cycles
	125 A iSW	2 500 cycles
Storage temperature	-20°C to +50°C	
Tropicalization	-40°C to +70°C	
	Treatment 2 (relative humidity 95% at 55°C)	

DB123587

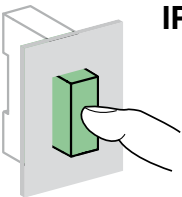

IP40

Connection

DB123135



9 mm
5 mm
PZ1

DB123136

9 mm
6.5 mm
PZ2

20, 32 A iSW

40 to 125 A iSW

Type	Rating	Tightening torque	Copper cables	
			Rigid	Flexible or ferrule
				
iSW	20, 32 A 40 to 125 A	1.2 N.m 3.5 N.m	10 mm ² ≤ 50 mm ²	10 mm ² ≤ 35 mm ²
OF iSW	-	1.2 N.m	10 mm ²	10 mm ²

Dimensions (mm)

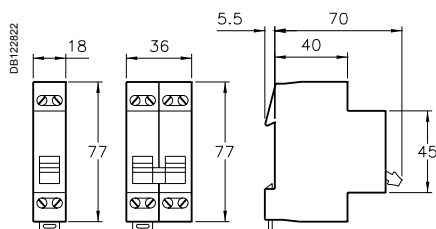

1P, 2P 3P, 4P
20, 32 A iSW

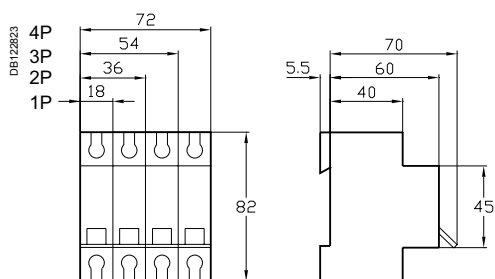

40 to 125 A iSW

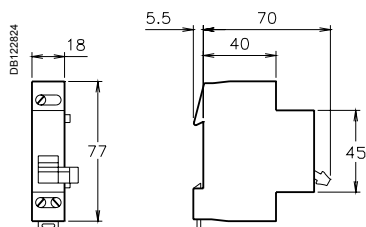

OF iSW

PB100253-40



The RCA remote control system allows:

- Remote electrical control (opening and closing) of circuit breakers with or without Vigi add-on RCD, with or without auxiliary.
- Circuit-breaker resetting after tripping, in accordance with safety principles and the regulations in force.
- Local control by operating handle.
- Circuit placing in safety configuration by padlocking.

2 choices of operation after tripping:

- A: Enabling of remote circuit-breaker resetting;
- B: Inhibition of remote resetting.

The version with Ti24 interface allows:

- Direct interfacing of remote control with a programmable logic controller (PLC), a supervision system and any other communication device, having inputs/outputs in 24 V DC (control, OF and SD indications).
- Remote indication by "OF" potential-free contact.
- Provision of 2 operating modes, "1 and 3".

The iMDU auxiliary allows RCA control in 24/48 V AC/DC.

Catalogue numbers

RCA remote control			
Type			Width in 9 mm modules
For circuit breakers 1P, 1P+N, 2P		Voltage	
Without Ti24 interface	230 V AC, 50 Hz	A9C70112	7
With Ti24 interface	230 V AC, 50 Hz	A9C70122	7
For 3P, 4P circuit breakers			
Without Ti24 interface	230 V AC, 50 Hz	A9C70114	7
With Ti24 interface	230 V AC, 50 Hz	A9C70124	7

DE123813



Without Ti24 interface

DE123572



DE123573



With Ti24 interface

Type		Application
OFF		All remote control inhibited
auto	A	Circuit breaker remote reclosing after tripping allowed
	B	Circuit breaker remote reclosing after tripping inhibited
Green indicator lamp		Remote control possible
Orange indicator lamp		Remote control impossible
1 (Ti24)		Mode 1
3 (Ti24)		Mode 3
Y1		Latched order local control
Y2		Impulse-type or latched order local control (depending on mode)
Y3		Latched order centralized control

Standard RCA

■ The orders received on terminals Y1 and Y2 are taken into account progressively in their order of arrival.

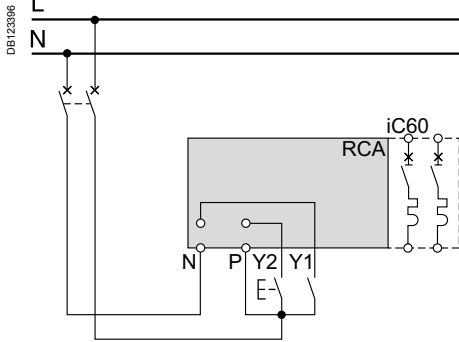

RCA Ti24

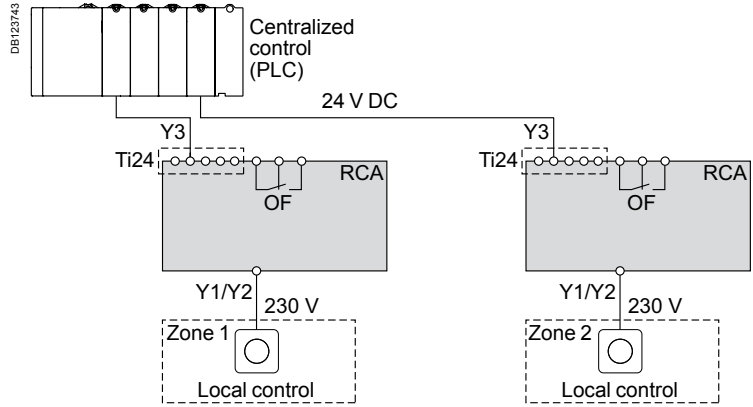

Mode 1: Locally or centrally controlled circuit-breaker opening/closing

- The orders come from various control points, and they are taken into account in their order of arrival
- Y1: Latched order local control
- Y2: Impulse-type local control
- Y3: Latched order centralized control

RCA Ti24 mode 1

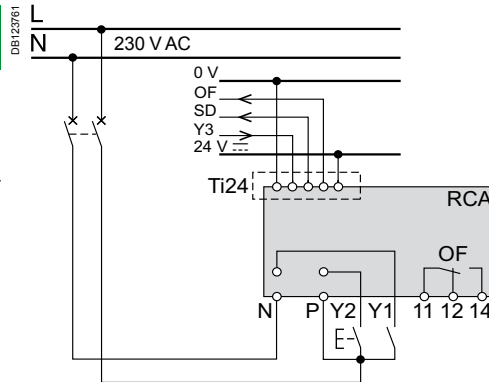

Mode 3: Centrally controlled opening/closing + local override

- 3 positions allowing a choice between override and centralized control:
- Y1: Latched order local control
- Y2: Latched order local control
- Y3: Latched order centralized control

RCA Ti24 mode 3

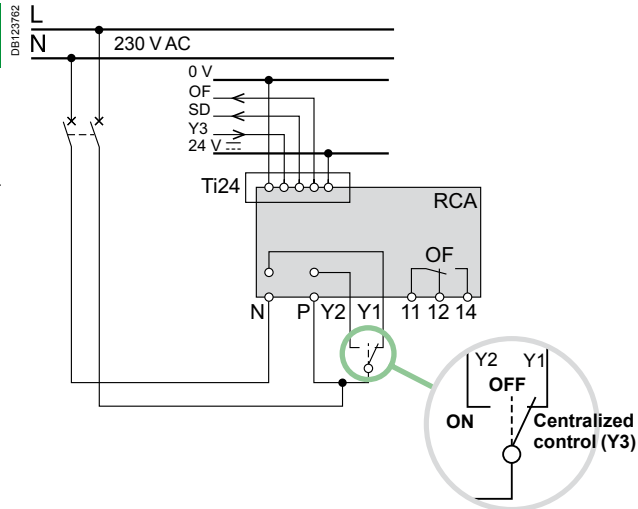

DB123576

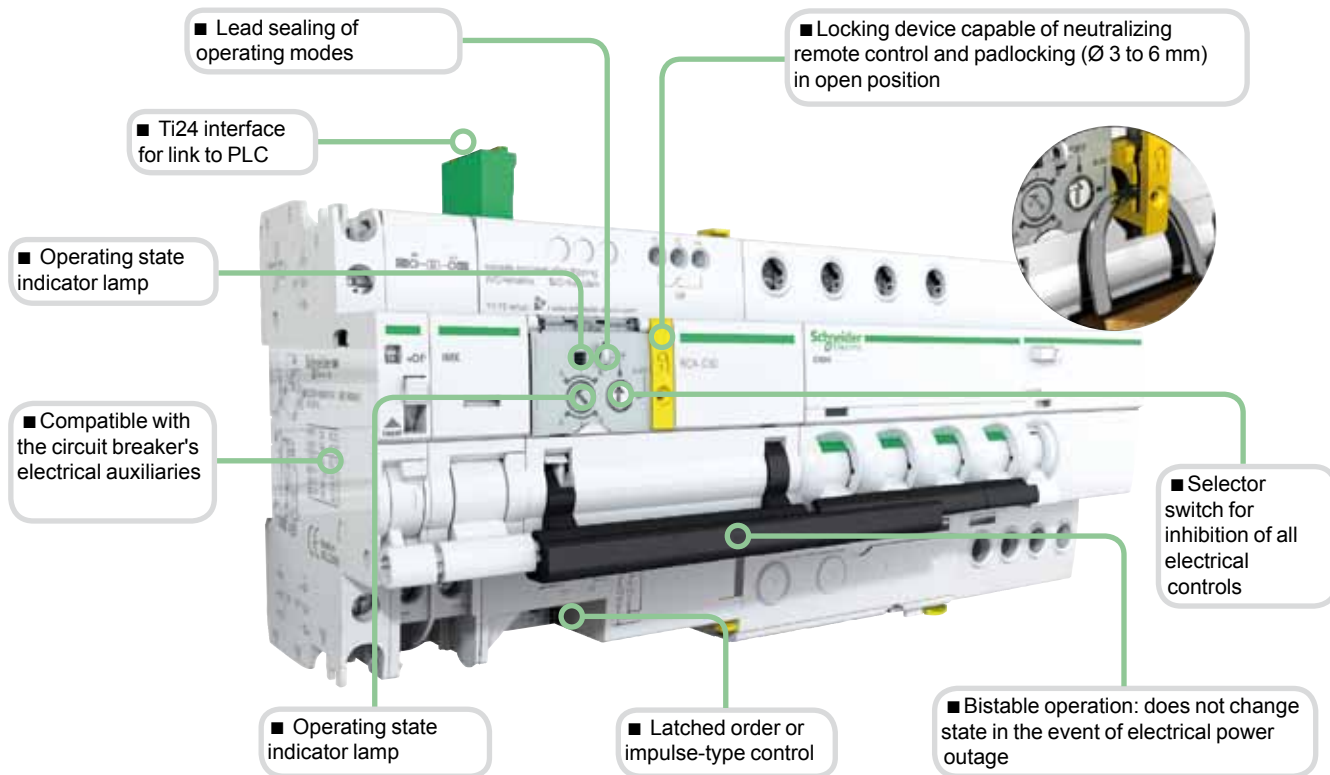

DB123763



DB123578



DB123579



Legend	
Type	Application
+24VDC	V DC power supply
Y3	Latched order centralized control
SD	Circuit-breaker tripping information
OF	Control circuit state information (open/closed)
0 V	V DC power supply
Y1	Latched order local control
Y2	Impulse-type or latched order local control (depending on mode)
N	230 V AC, 50 Hz power supply
P	
OF	Circuit-breaker state indication contact (open/closed)

11 12 14

Indication auxiliaries	Tripping auxiliaries	RCA remote control	iC60 circuit breaker	Vigi iC60 add-on RCD
 3	 2	 1		
No	1 (iSD or iOF or iOF/SD+OF)	1 (iMX or iMN) max.		
1 iOF	1 (iSD or iOF or iOF/SD+OF)	No	 RCA	 iC60
				 Vigi iC60

Connection

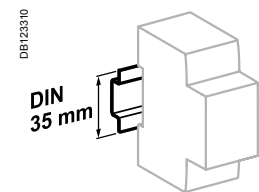
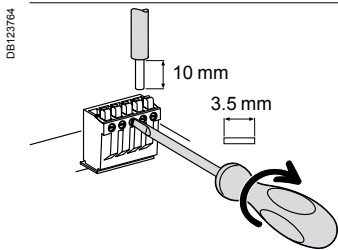
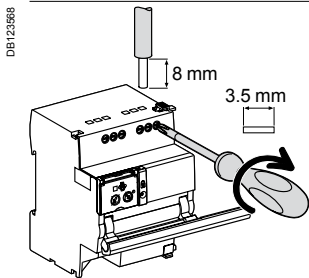
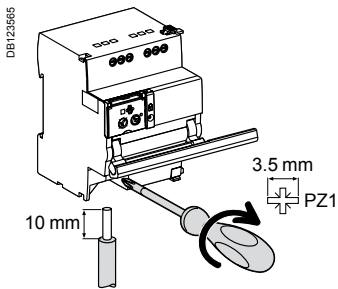

Clip on DIN rail 35 mm.

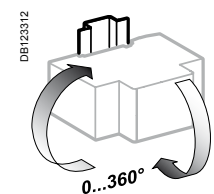

Indifferent position of installation.

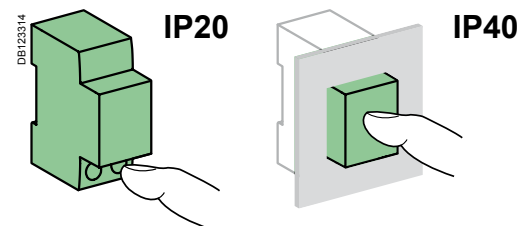

Without accessories

Terminal	Tightening torque	Copper cables		
		Rigid	Flexible	Flexible with ferrule
Power supply (N/P) Inputs (Y1/Y2)	1 N.m	0.5 to 10 mm ² 2 x 0.5 to 2 x 2.5 mm ²	0.5 to 6 mm ² 2 x 0.5 to 2 x 2.5 mm ²	0.5 to 4 mm ² 2 x 0.5 to 2 x 2.5 mm ²
Outputs (OF)	0.7 N.m	0.5 to 2.5 mm ² 2 x 0.5 to 2 x 1.5 mm ²	0.5 to 2.5 mm ² 2 x 0.5 to 2 x 1.5 mm ²	0.5 to 1.5 mm ² 2 x 0.5 to 2 x 1.5 mm ²
Ti24 interface	Spring-loaded terminals	0.5 to 1.5 mm ²	0.5 to 1.5 mm ²	-

Technical data

Control circuit		
Supply voltage (Ue) (N/P)		230 V AC, 50 Hz
Control voltage (Uc)	Type 1 inputs (Y1/Y2)	230 V AC (as per IEC 61131-2)
Min. duration of control order (Y2)		≥ 200 ms
Response time (Y2)		< 500 ms
Consumption		≤ 1 W
Thermal self-protection with automatic Reset against overheating of the control circuit due to an abnormal number of operations		
Endurance (O-C) (RCA combined with a circuit breaker)		
Electrical/Mechanical		10,000 cycles
Indication / Remote control		
Potential free changeover contact output (OF)	Min.	24 V AC/DC, 10 mA
	Max.	230 V AC, 1 A
Input (Y1/Y2)	230 V AC	5 mA
Ti24 interface (as per IEC 61131)		
Type 1 input (Y3)	24 V DC	5.5 mA
Output (OF and SD)	24 V DC	In max.: 100 mA
Additional characteristics		
Degree of protection (IEC 60529)	Device only	IP20
	Device in a modular enclosure	IP40
		Insulation class II
Insulation voltage (Ui)		400 V
Degree of pollution (IEC 60947)		3
Rated impulse withstand voltage (Uimp)		6 kV
Operating temperature		-25°C to +60°C
Storage temperature		-40°C to +70°C
Tropicalization		Treatment 2 (relative humidity of 93 % at +40°C)

Weight (g)

Remote controls	
Type	RCA
For 1P, 1P+N, 2P circuit breakers	400
For 3P, 3P+N, 4P circuit breakers	430

Dimensions (mm)

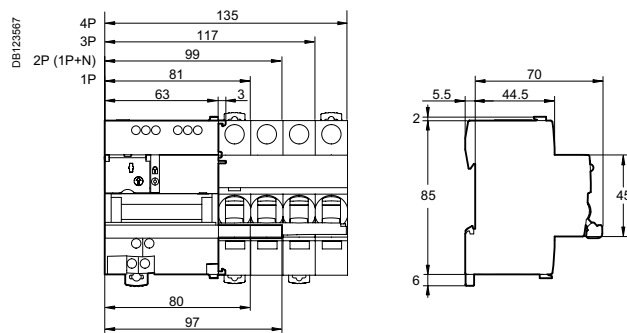

ARA automatic reclosers

For iC60 circuit breakers
and iID residual current circuit breakers



The ARA reclosing auxiliary can:

- Perform automatic reclosing of the associated protection device, after tripping.
- Increase the availability of installations without supervision, isolated, hard of access and demanding very great availability (mobile telephony systems, motorways, pumping stations, airports, railways, meteorological stations, service stations, automatic teller machines, public lighting, tunnels, etc.), by restoring them to operation without intervention by personnel in the event of a transient fault (atmospheric disturbances, industrial overvoltages, etc.).
- The operator can choose predefined reclosing program which allows the safety and availability of facilities to be reconciled taking into account the facility's environment.
- The circuit is placed in safety configuration by the padlocking device.



Catalogue numbers

ARA iC60				
For circuit breaker				Width in 9 mm modules
1P, 1P+N, 2P	Number of programs	Voltage		
	4	230 V AC, 50 Hz	A9C70132	7
3P, 4P				
	4	230 V AC, 50 Hz	A9C70134	7

ARA iID				
For residual current circuit breaker				Width in 9 mm modules
2P	Number of programs	Voltage		
	1	230 V AC, 50 Hz	A9C70342	7
	4	230 V AC, 50 Hz	A9C70332	
4P				
	4	230 V AC, 50 Hz	A9C70334	7

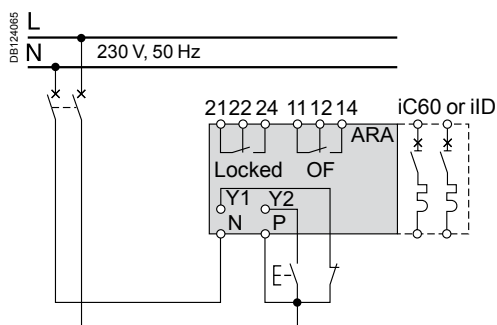
Diagram



Legend		Application
Type		
1	2	Choice of program
4	3	
Y1		"Remote" inhibition of automatic reclosing
Y2		Remote control of final reclosing
N		230 V power supply
P		
Locked		Automatic recloser inhibition indication contact
OF		Indicates the state of the circuit breaker or residual current circuit breaker (opened or closed)
Indicator lamp	Flashing green	Normal operation
	Flashing red	Reclosing cycle in progress
	Fixed red	Automatic recloser inhibited



ARA automatic reclosers (cont.)

For iC60 circuit breakers

and iID residual current circuit breakers

Operating principle

The ARA automatic recloser makes a number of attempts at reclosing depending on the program chosen by the user.

The program includes the following settings:

- A time delay before reclosing (TA).
- A reinitialization time delay (TB).
- A maximum number of reclosing attempts.

If, following these attempts, the fault is still present, the device places itself in waiting for manual reclosing, or final remote reclosing (Y2).

DB 123832

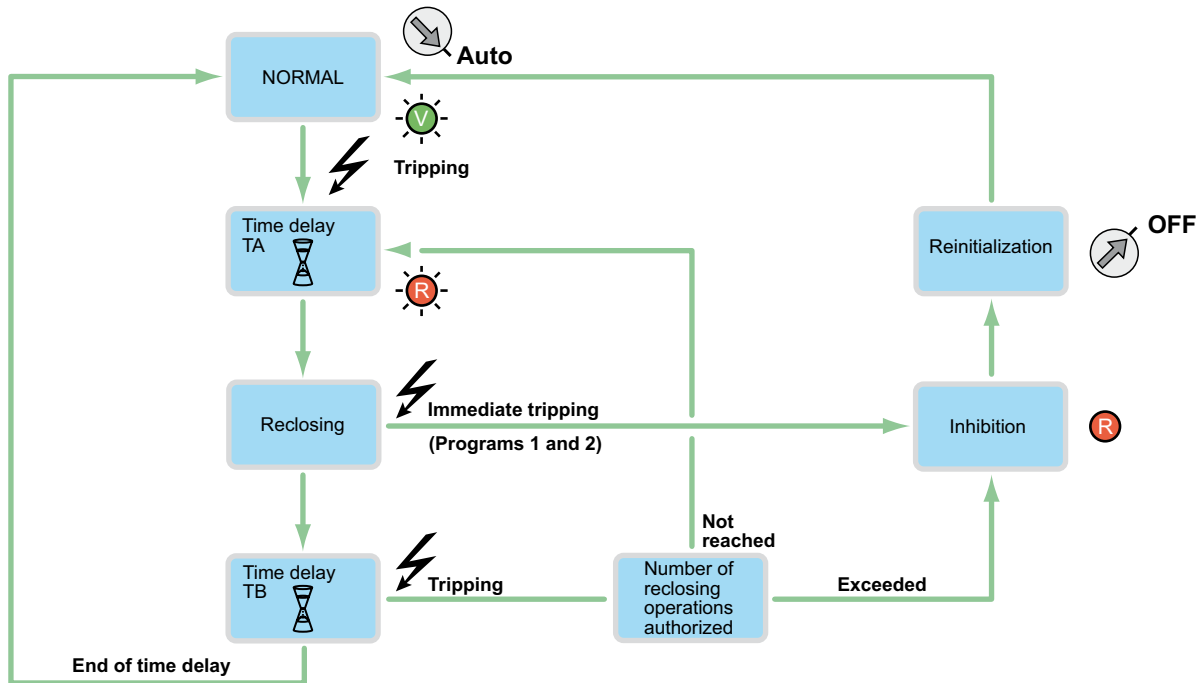

DB124061

DB124062

DB124063

DB124064

DB124063

DB124064

				Number of reclosing attempts	Delay before reclosing	Check time	Final reclosing Y2	
					TA	TB		
		iC60	iID					
		1P, 1P+N, 2P: A9C70132 3P, 4P: A9C70134	2P: A9C70342 2P: A9C70332 4P: A9C70334					
Program		-	1 program 4 programs					
1	2	■	-	1	60 s	6 min.	Once after inhibition	
4	3	■	■	3	60 s 3 min. 3 min.	2 min. 6 min. 6 min.		
1	2	■	-	5	60 s 3 min. 3 min. 3 min.	2 min. 6 min. 6 min. 6 min.		
4	3	■	-	5	60 s 3 min. 4 min. 5 min. 6 min.	2 min. 6 min. 8 min. 10 min. 12 min.		
1	2	-	■	5	60 s 4 min. 10 min. 1 h 6 h	2 min. 3 min. 6 min. 10 min. 10 min.		Once per cycle
4	3	-	■	15	20 s 40 s 3 min. 3 min. ...	30 min. 30 min. ...		
Only 1 program available		-	■	-				

ARA automatic reclosers (cont.)

For iC60 circuit breakers
and iID residual current circuit breakers

PB106050-78

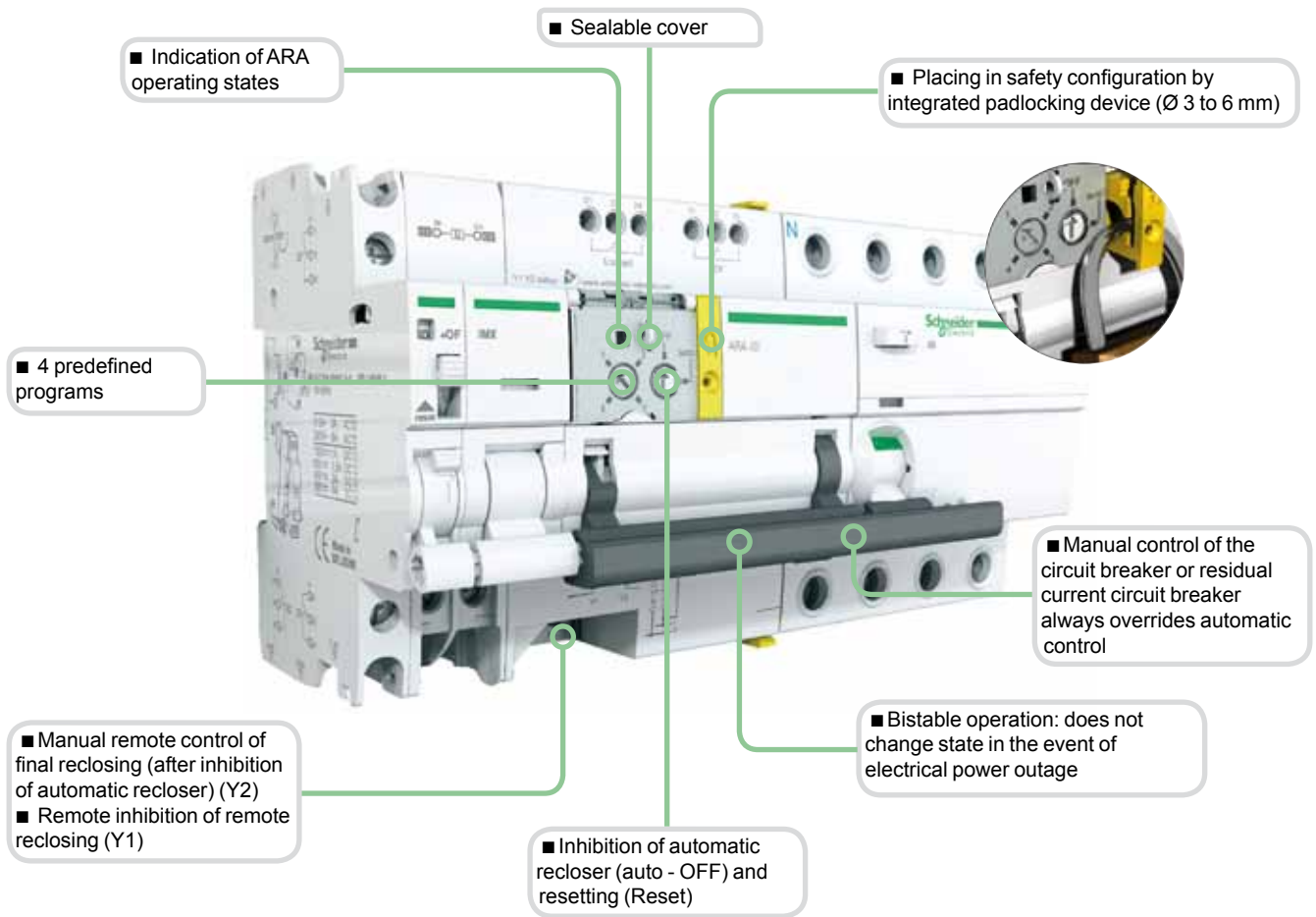

Indication auxiliaries	Tripping auxiliaries	ARA remote control	iC60 or iID device	Vigi iC60 add-on RCD
No	1 (iSD or iOF or iOF/SD+OF)	1 (iMX or iMN) max.		
1 iOF	1 (iSD or iOF or iOF/SD+OF)	No	 ARA	 iC60 iID
				 Vigi iC60

PB104474-25

PB104475-25

PB104485-25

PB106256-25

PB104437-25

PB104437-25

PB104472-25

ARA automatic reclosers (cont.)

For iC60 circuit breakers
and iID residual current circuit breakers

Connection

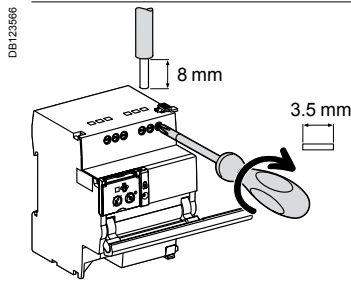
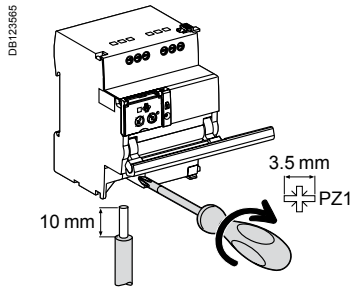

Terminal	Tightening torque	Without accessories		
		Copper cables		
		Rigid	Flexible	Flexible with ferrule
Power supply (N/P) Inputs (Y1/Y2)	1 N.m	0.5 to 10 mm ² 2 x 0.5 to 2 x 2.5 mm ²	0.5 to 6 mm ² 2 x 0.5 to 2 x 2.5 mm ²	0.5 to 4 mm ² 2 x 0.5 to 2 x 2.5 mm ²
Outputs (OF/Locked)	0.7 N.m	0.5 to 2.5 mm ² 2 x 0.5 to 2 x 1.5 mm ²	0.5 to 2.5 mm ² 2 x 0.5 to 2 x 1.5 mm ²	0.5 to 1.5 mm ² 2 x 0.5 to 2 x 1.5 mm ²

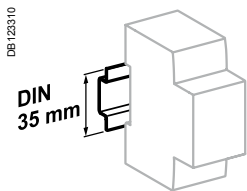

Clip on DIN rail 35 mm.

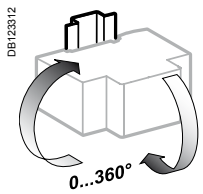

Indifferent position of installation.

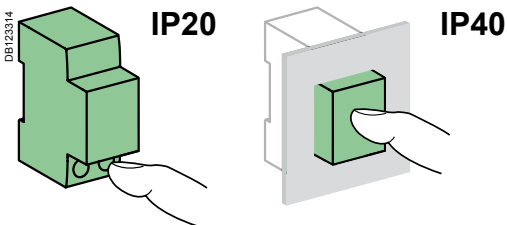

Technical data

Control circuit		
Supply voltage (Ue) (N/P)		230 V AC, 50 Hz
Control voltage (Uc)	Type 1 inputs (Y1/Y2)	230 V AC (as per IEC 61131-2)
Min. duration of control order (Y2)		≥ 200 ms
Response time (Y2)		< 500ms
Consumption		≤ 1 W
Thermal self-protection with automatic Reset against overheating of the control circuit due to an abnormal number of operations		
Endurance (O-C) (ARA combined with a circuit breaker)		
Electrical		5000 cycles
Indication / Remote control		
Potential-free changeover contact output (OF/Locked)	Min.	24 V AC/DC, 10 mA
	Max.	230 V AC, 1 A
Input (Y1/Y2)	230 V AC	5 mA
Additional characteristics		
Degree of protection (IEC 60529)	Device only	IP20
	Device in a modular enclosure	IP40 Insulation class II
Insulation voltage (Ui)		400 V
Degree of pollution (IEC 60947)		3
Rated impulse withstand voltage (Uimp)		6 kV
Operating temperature		-25°C to +60°C
Storage temperature		-40°C to +70°C
Tropicalization		Treatment 2 (relative humidity of 93 % at +40°C)

ARA automatic reclosers (cont.)

For iC60 circuit breakers
and iLD residual current circuit breakers

Weight (g)

Automatic reclosers	
Type	ARA
For 1P, 1P+N, 2P circuit breakers or iLD 2P residual current circuit breaker	440
For 3P, 4P circuit breakers or iLD 4P residual current circuit breaker	470

Dimensions (mm)

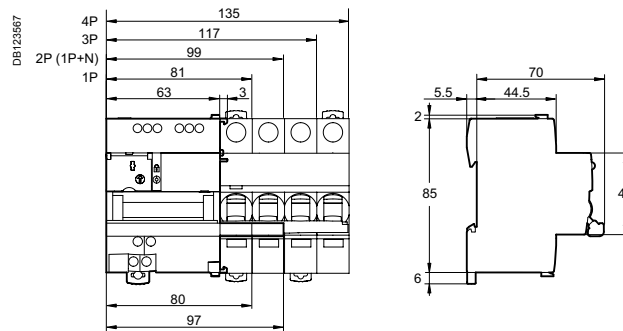

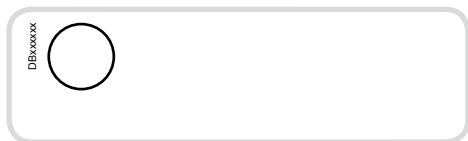

IEC/EN 60947-2

The Reflex iC60 devices are integrated control circuit breakers which combine the following main functions in a single device:

- Remote control by latched and/or impulse-type order according to the 3 operating modes to be chosen by the user.
- Circuit breaker, to provide:
 - circuit protection against short-circuit currents,
 - circuit protection against overload currents,
 - disconnection in the industrial sector.

Resetting after a fault is performed manually, by the resetting handle.

The version with Ti24 allows direct interfacing of the Reflex iC60 with a PLC, to:

- Execute remote control (Y3).
- Indicate the state of the control circuit (OF) or circuit-breaker tripping (SD).

The iMDU auxiliary allows the Reflex iC60 to be controlled in 24/48 V AC/DC.

PB106239-40



PB106239-40



Alternating current (AC) 50 Hz			
Ultimate breaking capacity (Icu) as per IEC/EN 60947-2			Service breaking capacity (Ics)
Ph/Ph (2P, 3P, 4P)	Voltage (Ue)		
	220 to 240 V	380 to 415 V	
Reflex iC60N			
Rating (In)	10 to 40 A	20 kA	10 kA
			75 % of Icu
Reflex iC60H			
Rating (In)	10 to 40 A	30 kA	15 kA
			75 % of Icu

Catalogue numbers

Reflex iC60 circuit breaker									
Type	2P			3P			4P		
Rating (In)	Curve			Curve			Curve		
	B	C	D	B	C	D	B	C	D
Reflex iC60N									
With Ti24 interface									
10 A	A9C61210	A9C62210	A9C63210	A9C61310	A9C62310	A9C63310	A9C61410	A9C62410	A9C63410
16 A	A9C61216	A9C62216	A9C63216	A9C61316	A9C62316	A9C63316	A9C61416	A9C62416	A9C63416
25 A	A9C61225	A9C62225	A9C63225	A9C61325	A9C62325	A9C63325	A9C61425	A9C62425	A9C63425
40 A	A9C61240	A9C62240	-	A9C61340	A9C62340	-	A9C61440	A9C62440	-
Without Ti24 interface									
10 A	-	A9C52210	-	-	A9C52310	-	-	A9C52410	-
16 A	-	A9C52216	-	-	A9C52316	-	-	A9C52416	-
25 A	-	A9C52225	-	-	A9C52325	-	-	A9C52425	-
40 A	-	A9C52240	-	-	A9C52340	-	-	A9C52440	-
Reflex iC60H									
With Ti24 interface									
10 A	A9C64210	A9C65210	A9C66210	A9C64310	A9C65310	A9C66310	A9C64410	A9C65410	A9C66410
16 A	A9C64216	A9C65216	A9C66216	A9C64316	A9C65316	A9C66316	A9C64416	A9C65416	A9C66416
25 A	A9C64225	A9C65225	A9C66225	A9C64325	A9C65325	A9C66325	A9C64425	A9C65425	A9C66425
40 A	A9C64240	A9C65240	-	A9C64340	A9C65340	-	A9C64440	A9C65440	-
Width in 9 mm modules	9			11			13		
Vigi iC60	Vigi iC60 add-on residual current device, module CA902005			Vigi iC60 add-on residual current device, module CA902005			Vigi iC60 add-on residual current device, module CA902005		
iMDU auxiliaries	A9C18195			A9C18195			A9C18195		
Accessories	Module CA907001			Module CA907001			Module CA907001		

(1) Information to be supplied by the country concerned.

Reflex iC60N, iC60H (curves B, C, D) (cont.)

PB1C05880_W_70

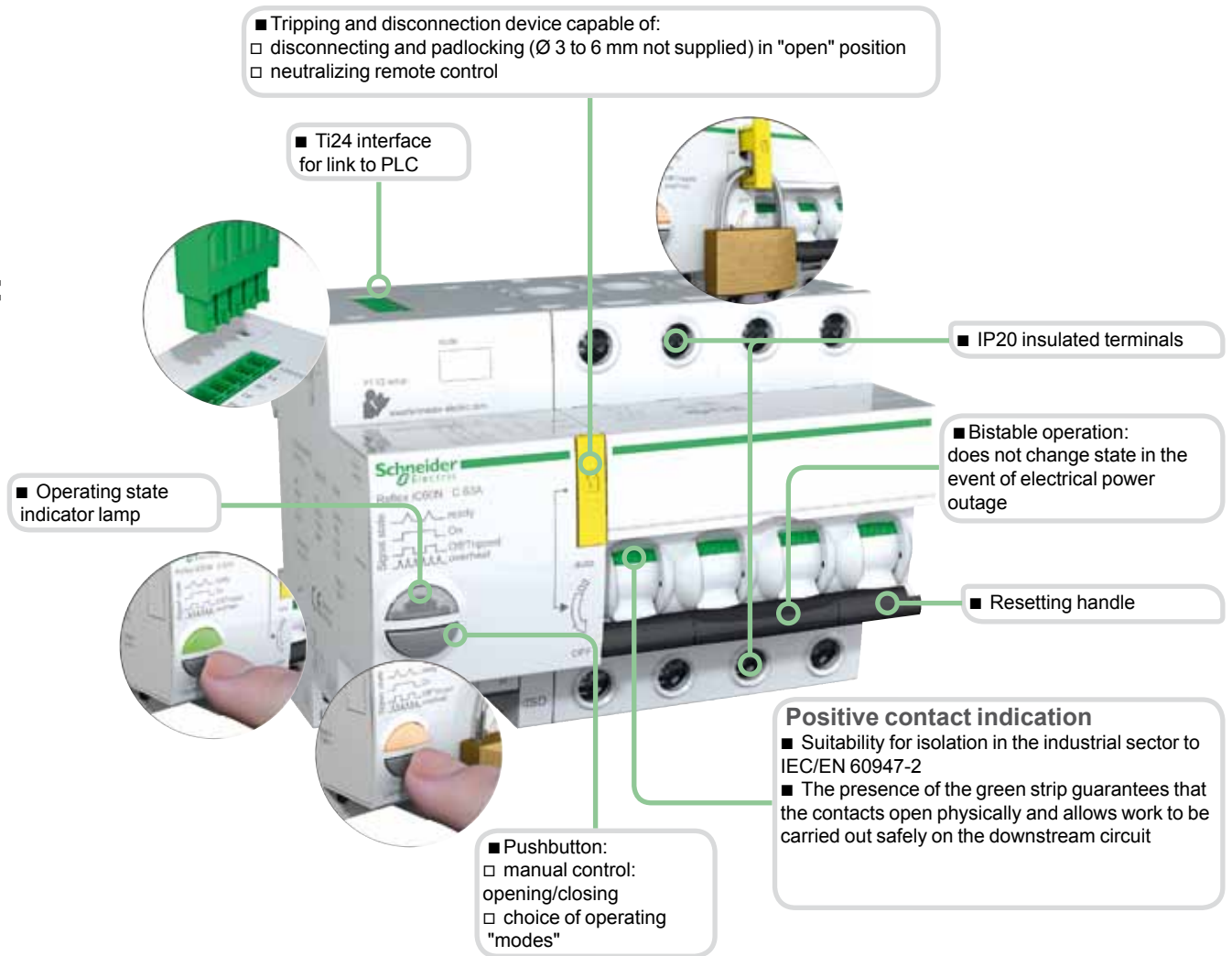

■ Longer product service life thanks to:

- good overvoltage withstand capacity: products designed to provide a high industrial performance level (degree of pollution, rated impulse withstand voltage and insulation voltage),
- high limitation performances (see limitation curves),
- fast closure independent of the speed of resetting of the operating handle.

DB123765



DB123516



Legend

Ti24 interface

+24VDC	V DC power supply
Y3	Remote control by latched order
SD	Circuit-breaker tripping information
OF	Control circuit state information (open/closed)
0 V	V DC power supply

Y1	Latched order local control
Y2	Control by impulse-type or latched order (depending on mode)
N	230 V AC power supply
P	
OF	Control circuit state indication contact
SD	Circuit-breaker tripping indication contact

DB123517



■ Operating state indicator lamp

■ Pushbutton for:
□ "mode" selection
□ opening/closing manual control

Remote control is possible by 3 operating modes to be set using the pushbutton on the front panel.

Operating mode

DB123766

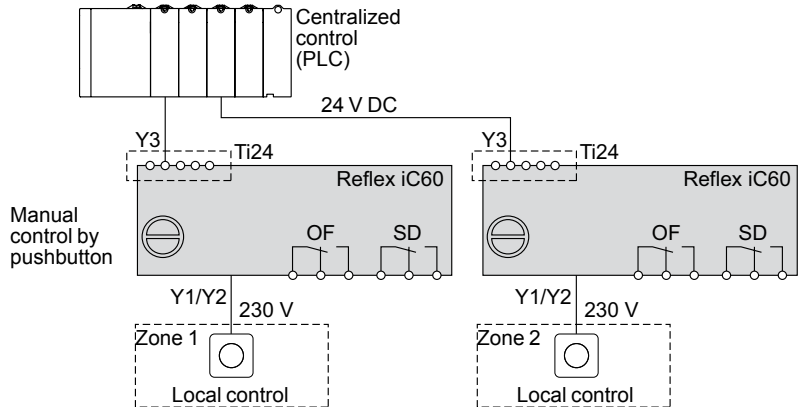

Mode 1: locally or centrally controlled circuit-breaker opening/closing

- The orders come from various control points, and they are taken into account in their order of arrival
- Y1: latched order local control
- Y2: impulse-type local control
- Y3: latched order centralized control

Mode 2: locally controlled opening/closing, centrally controlled opening

- The orders come from various control points.
- Only the stoppage orders are taken into account by the inputs Y1, Y3
- Y1: latched order local opening control
- Y2: impulse-type local opening/closing control
- Y3: latched order centralized opening control

Mode 3: centrally controlled opening/closing + local override

- 3 positions allowing a choice between override and centralized control:
- Y1: latched order local control
- Y2: latched order local control
- Y3: latched order centralized control

Reflex iC60 or Reflex iC60 Ti24 modes 1 and 2

DB123767

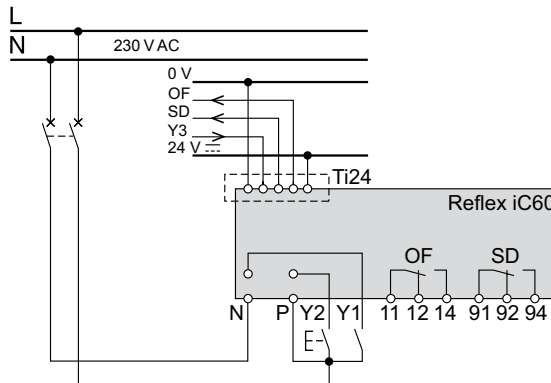

Reflex iC60 Ti24 mode 3

DB123768

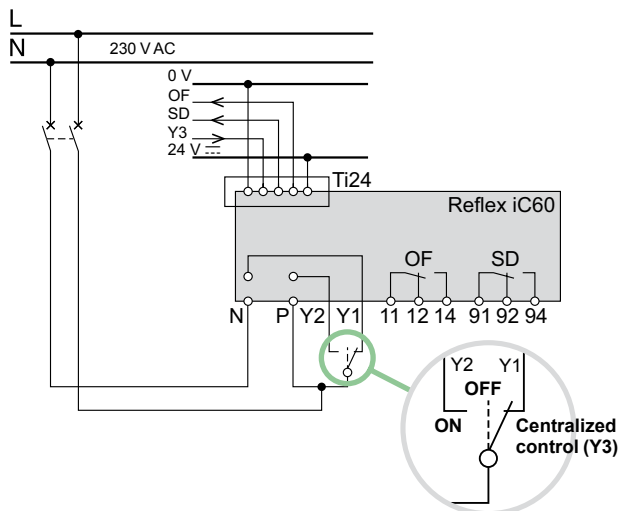
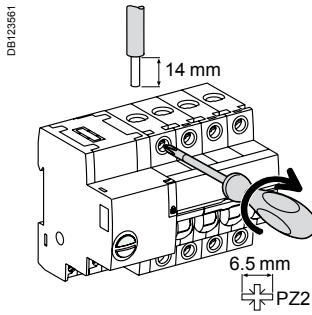

Table of modes

	Mode 1	Mode 2	Mode 3
Reflex iC60 without interface	■ Default mode	■ Possible mode	–
Reflex iC60 Ti24 with interface	■ Possible mode	■ Possible mode	■ Default mode

Connection



Terminal	Rating	Tightening torque	Without accessories		With accessories				
			Copper cables		Al terminal 50 mm ²	Screw-on connection for ring terminal	Multi-cable terminal		
			Rigid	Flexible or with ferrule			Rigid cables	Flexible cables	
			DBI122945 	DBI122946 	DBI122935 	DBI118789 	DBI118787 		
Power	10 to 25 A 40 A	2 N.m 3.5 N.m	1 to 25 mm ² 1 to 35 mm ²	1 to 16 mm ² 1 to 25 mm ²	- 50 mm ²	∅ 5 mm	- 3 x 16 mm ²	- 3 x 10 mm ²	

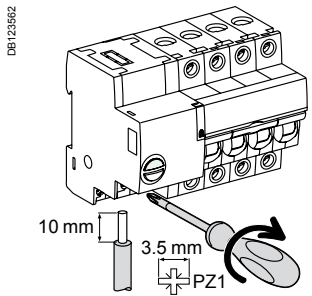

Terminal	Tightening torque	Without accessories		
		Rigid	Flexible	Flexible with ferrule
		DBI122945 	DBI123553 	DBI123554
Power supply (N/P) Inputs (Y1/Y2)	1 N.m	0.5 to 10 mm ² 2 x 0.5 to 2 x 2.5 mm ²	0.5 to 6 mm ² 2 x 0.5 to 2 x 2.5 mm ²	0.5 to 4 mm ² 2 x 0.5 to 2 x 2.5 mm ²

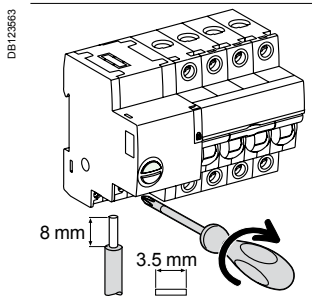

Outputs (OF/SD)	0.7 N.m	0.5 to 2.5 mm ² 2 x 0.5 to 2 x 1.5 mm ²	0.5 to 2.5 mm ² 2 x 0.5 to 2 x 1.5 mm ²	0.5 to 1.5 mm ² 2 x 0.5 to 2 x 1.5 mm ²
------------------------	---------	--	--	--

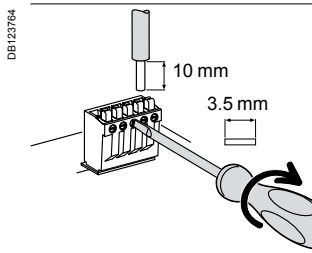

Ti24 interface	Spring-loaded terminals	0.5 to 1.5 mm ²	0.5 to 1.5 mm ²	0.5 to 1.5 mm ²
-----------------------	-------------------------	----------------------------	----------------------------	----------------------------

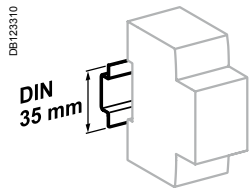

Clip on DIN rail 35 mm.

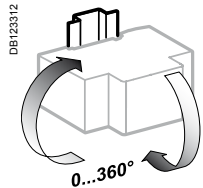

Indifferent position of installation.

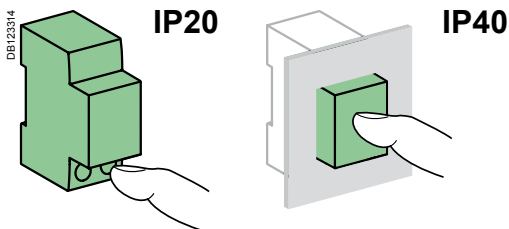

Technical data

Control circuit

Supply voltage (Ue) (N/P)	230 V AC, 50 Hz	
Control voltage (Uc)	Inputs (Y1/Y2)	230 V AC
		24...48 V AC/DC, with iMDU auxiliary
Min. duration of control impulse (Y2)	≥ 250 ms	
Response time (Y2)	≤ 200 ms	
Consumption	≤ 1 W	

Thermal self-protection with automatic Reset against overheating of the control circuit due to an abnormal number of operations

Power circuit

Max. working voltage (Ue)	400 V AC	
Max. working voltage (Ue)	500 V	
Rated impulse withstand voltage (Uimp)	6 kV in disconnected position	
Thermal tripping	Reference temperature	50°C
	Curve B	4 In ± 20 %
	Curve C	8 In ± 20 %
Magnetic tripping	Curve D	12 In ± 20 %
Overvoltage category (IEC 60364)	IV	

Endurance (O-C)

Electrical	AC1	30,000 cycles
	AC5a	6000 cycles
	AC5b	6000 cycles
	AC21	50,000 cycles
Mechanical	> 50,000 cycles	

Indication / Remote control

Potential-free changeover contact outputs (OF/SD)	Min.	48 V DC, 1 A
	Max.	230 V AC, 1 A
Inputs (Y1/Y2)	230 V AC	5 mA

Ti24 interface (as per IEC 61131)

Type 1 input (Y3)	24 V DC	5.5 mA
Outputs (OF/SD)	24 V DC	In max: 100 mA

Additional characteristics

Degree of protection (IEC 60529)	Device only	IP20
	Device in a modular enclosure	IP40 Insulation class II
Degree of pollution	3	
Operating temperature	-25°C to +60°C	
Storage temperature	-40°C to +85°C	
Tropicalization	Treatment 2 (relative humidity of 93 % at 40°C)	

Reflex iC60N, iC60H (curves B, C, D) (cont.)

Weight (g)

Circuit breaker	
Type	Reflex iC60
2P	480
3P	620
4P	750



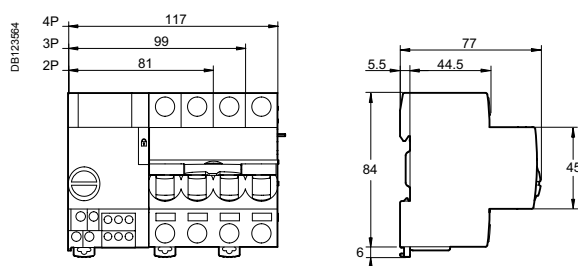

Dimensions (mm)



IEC 60947-5-1

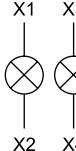
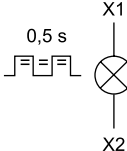
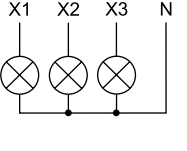

■ iIL indicator lights light up to indicate that a voltage is present.

Catalogue numbers

iIL indicator lights										
Type	Single					Double		Flashing light	Three-phase voltage presence indicator light	
										
Diagram	 X1- X2+					 X1 X3 X2 X4		 0,5 s X1 X2	 X1 X2 X3 N	
Colour	Red	Green	White	Blue	Yellow	Green/red	White/white	Red	Red/red/red	
Cat. no.										
12...48 V AC/DC	A9E18330	A9E18331	A9E18332	A9E18333	A9E18334	A9E18335	-	-	-	
110...230 V AC	A9E18320	A9E18321	A9E18322	A9E18323	A9E18324	A9E18325	A9E18328	A9E18326	-	
230...400 V AC (3 phases)	-	-	-	-	-	-	-	-	A9E18327	
Width in 9 mm modules	2					2		2	2	

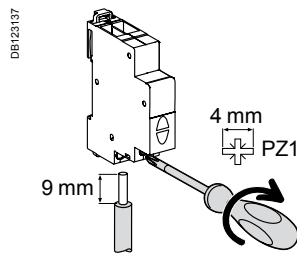
Connection



Tightening torque	Copper cables	
	Rigid	Flexible or ferrule
1 N.m	 0.5 mm ² min. 2 x 2.5 mm ² max.	 0.5 mm ² min. 2 x 2.5 mm ² max.

- Phase-separated wall that can be divided to allow the teeth of all types of comb busbar to pass through.
- Staggered terminals to simplify connection.

Dimensions (mm)

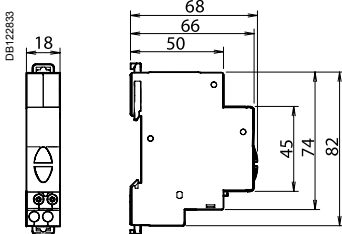

Technical data

Main characteristics	
Pollution degree	3
Power circuit	
Operating frequency	50...60 Hz
Flashing frequency	2 Hz
Additional characteristics	
Operating temperature	-35°C... +70°C
Storage temperature	-40°C... +80°C
Tropicalization	Treatment 2 (relative humidity 95 % at 55°C)
LED indicator light	Consumption per indicator light: 0.3 W
	Service life: 100,000 hours of constant lighting efficiency
	Maintenance-free indicator light (non-interchangeable LEDs)



Power supply of rows from the incoming line

Busbar selection aid



Type of distribution		Busbars	
Selection criteria		Bare busbars to be formed	Insulated busbars
Speed of installation		● medium	● high
Personnel safety		● medium	● high
Specific features		-	For Prisma Plus switchboards

Bare busbars to be formed

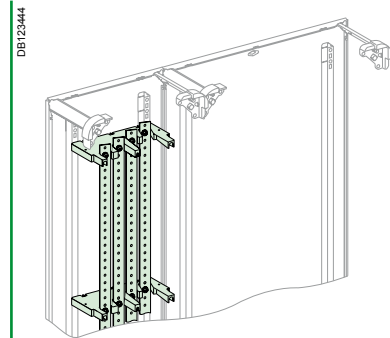
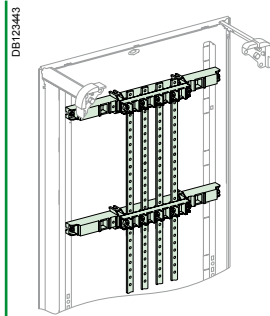

Type		In enclosure			In duct			
Rating		160 A	250 A	400 A	160 A	250 A	400 A	630 A
Conductor cross section (mm)		15 x 5 mm	20 x 5 mm	32 x 5 mm	15 x 5 mm	20 x 5 mm	32 x 5 mm	32 x 8 mm
Spacing between supports according to Icw	10 kA rms/1 s	450 mm			450 mm			
	13 kA rms/1 s	-	450 mm		-	450 mm		
	15 kA rms/1 s	-	-	450 mm	-	-	450 mm	
	20 kA rms/1 s	-	-	300 mm	-	-	300 mm	
	25 kA rms/1 s	-	-	225 mm	-	-	-	300 mm
	25 kA rms/0.6 s	-	-	-	-	-	300 mm	-
Characteristics		Set of 4 cuttable bars M6 tapping to a pitch of 25 mm Direct installation on the frame of Prisma Plus enclosures and cabine			Set of 4 cuttable bars M6 tapping to a pitch of 25 mm Direct installation on the frame of Prisma Plus enclosures and cabinets			
Cat. no.	Support	04191			04192			
	Bars	1000 mm	04161	04162	04163	04161	04162	04163
	1400 mm	04171	04172	04173	04171	04172	04173	04174

Accessories

Type		Cat. no.	
Screen		04198 H = 100 mm	04197 H = 1500 mm
4 connections		04145 : 125 A (230 mm) for NG125, NSA, INS provided with tunnel terminals or comb busbar	-
		04146 : 160 A for NSA160	-
		04029 : 200 A for Multiclip 200 A	04024 : 200 A for Multiclip 200 A
Screws and nuts		04194 : 20 M6x20 bolts + 20 nuts + 40 washers 04195 : 40 M6x16 screws + 40 contact washers	

Power supply of rows from the incoming line

Insulated busbars

In Prisma Plus enclosures and cabinets

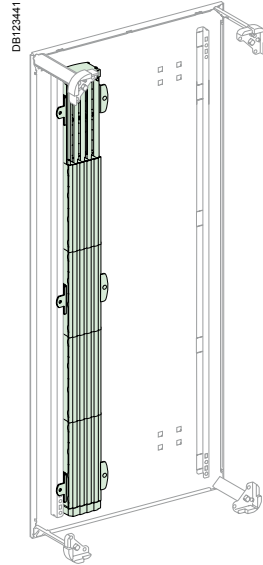
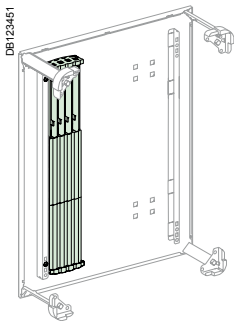

Powerclip for Prisma Plus enclosures

Type	Cat. no.
Rating	125 A
Three-pole	450 mm 04103
	750 mm 04107
Four-pole	450 mm 04104
	750 mm 04108
Characteristics	Cuttable to 150 mm pitch Delivered with clip-on and cut-out covers which insulate the lugs of a power supply connection M6 tapping to a pitch of 25 mm Direct installation on the frame of Prisma Plus enclosures and cabinets

Accessories

Type	Cat. no.
4 connections	04145 : 125 A (230 mm) for NG125, NSA, INS provided with tunnel terminals or comb busbar

Powerclip for Prisma Plus cabinets

Type	Cat. no.
Rating	160 A 250 A 400 A 630 A
Three-pole	1000 mm 04111 04112 04113 04114
	1400 mm 04116 04117 04118 04119
Four-pole	1000 mm 04121 04122 04123 04124
	1400 mm 04126 04127 04128 04129
Characteristics	Cuttable to 200 mm pitch M6 tapping to a pitch of 25 mm Direct installation on the frame of Prisma Plus enclosures and cabinets

Accessories

Type	Cat. no.
Busbar power supply from a Compact NSX	For horizontal NSXs Power packs with connections 04060 : NSX250 04070 : NSX400 04071 : NSX630
	For horizontal NSXs Universal power packs + connections 04062 + 04061 : NSX100/250 in enclosure 04064 + 04061 : NSX100/250 in duct 04073 + 04074 : NSX400/630 in duct
Tubular bare lugs drilling dia. 6.4 mm, 90° angled	25222326 : for 10 mm ² cables 25222331 : for 16 mm ² cables 25222344 : for 25 mm ² cables
Connections with Multiclip 200 A supplied with screws and nuts	04021
Power supply of rows	Set of 12 branch terminals 04151 : for 1 cable of 6 mm ² and 1 of 10 mm ² 04152 : for 1 cable of 16 mm ²
Protection of connection lugs Set of 8 clip-on and cut-out covers, to maintain IPxB with 90° angled lugs and/or cable cross sections of 10 to 25 mm ²	04150
Class 8.8 screws and nuts Set of 20 hex skt hd cap screws, M6 x 12	04158

Power supply of rows from the incoming line



Splitter block selection aid



Type of splitter block		Single-pole to be combined		Multipolar	
		Fast	Screw-on	Fast	Screw-on
Selection criteria	Flexibility	● high		● low	
	Compactness	● medium		● high	
	Maintenance	● easy	● complicated	● easy	● complicated

Single-pole splitter blocks to be combined

Fast connection		80 A (to be formed)	125 A (to be formed)	160 A
Rating		Example of composition	Example of composition	Polybloc
				
Detail dia. for flexible cables	6 mm ²	28	28	6
	25 mm ²	1 tunnel terminal	1 tunnel terminal	
	70 mm ²			1 tunnel terminal
Size	in 9 mm modules	12.5		4.5
	in 18 mm modules	6.5		2.5
Characteristics		Clip-on to rail		Clip-on to rail
Cat. no.		PRA90048 : splitter block kit + PRA90050 : junction kit + PRA90047 : 10 blocks of 4x6 mm ² + PRA90046 : 5 blocks of 25 mm ²	PRA90048 : splitter block kit + 2 x PRA90050 : junction kit + PRA90047 : 10 blocks of 4x6 mm ² + PRA90046 : 5 blocks of 25 mm ²	04031

Screw connection		80 A	80 A (to be formed)	125 A (to be formed)
Rating			Example of composition	Example of composition
				
Detail dia. for flexible cables	16 mm ²	4		
	25 mm ²	1	4	6
	35 mm ²		1	
	50 mm ²		1	1
Size	in 9 mm modules	?	?	12.5
	in 18 mm modules	?	?	6.5
Characteristics		Clip-on to rail		Clip-on to rail
Cat. no.		14936	14938	PRA90048 : splitter block kit + 2 x PRA90050 : junction kit + PRA90046 : 5 blocks of 25 mm ² + PRA90045 : 2 blocks of 50 mm ²

Note: Correspondence: Flexible cable/rigid cable

Cable type	Cross section in mm ²						
Flexible	1.5	2.5	4	6	10	16	25
Rigid	1.5	2.5 / 4	6	10	16	25	35

Power supply of rows from the incoming line

Multipolar splitter blocks

Fast connection						
Type	Distribloc				Polybloc	
Rating	63 A		125 A	160 A	250 A	250 A
Number of poles	4P		4P	4P	3P	4P
Total connection capacity (dia. for flexible cables)	4 mm ²		7			
	6 mm ²	12 per phase + 12 neutral	3			
	10 mm ²		2		18	24
	16 mm ²		1 tunnel terminal		9	12
	25 mm ²	4 tunnel terminals per phase + 1 neutral				
			1 tunnel terminal			
Characteristics	Incoming through the top Clip-on to rail	Incoming through the bottom Clip-on to rail	Set of 4 35 mm ² flexible connections, length 210 mm to be ordered separately (cat. no. 04047) Clip-on to rail	Set of 4 prefabricated flexible connections supplied, for connection with an INS100/160 or NSA160 switch, installed on the right or left Clip-on to rail	Direct installation on the terminals of Compact circuit breakers and Interpact switches	
Size	in 9 mm modules	8	8	12	12	16
	in 18 mm modules	4	4	6	6	8
Cat. no.	04040	04041	04045 + 04047	04046	04033	04034

Screw connection											
Number of poles	2P				4P						
Rating	80 A		100 A	125 A	40 A	100 A	125 A		160 A	250 A	400 A
Total connection capacity (dia. for flexible cables)	6 mm ²		3	5	11	3	5	7			
	10 mm ²		3	5	2	3	5	7			
	16 mm ²	4	1	2		1	2	2			
	25 mm ²	1	4	1			1	1			
	35 mm ²		1								
Characteristics	Clip-on to rail		Clip-on to rail		Clip-on to rail				4 + 13 To be screwed on back. 13 M6 tapped holes + 4 plain holes of dia. 12.2 mm		
Size	in 9 mm modules										
	in 18 mm modules										
Cat. no.	14937	14939	13506	13507	13508	13510	13512	13514	04052	04053	04054

Power supply of one row of switchgear

Distribution Selection aid



Type of distribution		Comb busbars	Splitter blocks	Wire-to-wire
Selection criteria	Management of monitoring/control cabling	● medium	● easy	● medium
	Maintenance and scalability	● medium	● high	● complicated

Comb busbars

Type		For DPN			For iC60 and C60		For C120 and NG125	
Rating		80 A			80 / 100 A		125 A	
Length	in 9 mm modules in 18 mm modules	24 12	48 24	96 48	24 12	48 24	45 22.5	48 24
Quantity per cat. no.		1			1		1	
Accessories included	Side plates	4			2		2	
	Tooth covers	1 (6 modules of 9 mm)	2 (6 modules of 9 mm)	-	-		8 for 1P or 2P comb busbars, 4 for 3P or 4P comb busbars	
Powered device module type		9 mm			18 mm		27 mm	
Characteristics		-			80 A with 1 power supply point 100 A with 2 power supply points		63 A maximum per outgoing line	
Cat. no.	1P	-	-	-	14881	14891	-	14811
	2P	21086	21088	21089	14882	14892	-	14812
	3P	-	-	-	14883	14893	14813	-
	4P	21090	21092	21093	14884	14894	-	14814
Accessories								
Type		Cat. no.						
Side plates		Sets of 40 side plates: 21094 : 2P 21095 : 4P			Set of 20 side plates + 16 tooth covers: 14886 : 1P, 2P 14887 : 3P, 4P		14818 : Set of 4 side plates + 20 tooth covers (2P, 3P, 4P)	
Tooth covers		21096 : 12 tooth covers (6 modules of 9 mm)			Set of 40 tooth covers: 14888			
Connectors		21098 : 4 connectors for 25 mm ² cable			21098 : 4 connectors for 25 mm ² cable		-	

Power supply of one row of switchgear

Splitter blocks

Type		Multiclip					
Rating		63 A	80 A	80 A	160 A	200 A	
							
Length	in 9 mm modules	24	48	96	24	48	
	in 18 mm modules	12	24	48	12	24	
Upstream connection capacity		Tunnel terminals for cables up to 25 mm ²		Tunnel terminals for cables up to 25 mm ²	Direct on connecting pads by 50 mm ² cables or by 20x3 flexible bar with a prefabricated connection from a busbar		
Downstream connection capacity	Max. 4 mm ²	Phase 2	Neutral 7	-	-	-	
	Max. 6 mm ²	Phase 2	Neutral 4	-	-	-	
	Max. 10 mm ²	Phase -	Neutral -	18	6	12	
Accessories included	Pre-stripped copper connections	10 of 4 mm ² + 6 of 6 mm ² (L=100 mm)		12 blue + 12 black	20 of 4 mm ² + 6 of 6 mm ² (L=100 mm)		
	Protective cover				For pads (IPxxB)		
	Screws and nuts				For pads		
Cat. no.	2P	-	-	-	-	04012	
	3P	-	-	-	-	04013	
	4P	04008	04004	04000	04018	04014	
Accessories							
Type		Cat. no.					
Connections				-	04030: 160 A between Multiclip and switchgear	200 A, between Multiclip and: 04021: Powerclip busbar 04029: back busbar 04024: busbar in duct	

Wire-to-wire

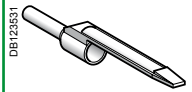
Single end-pieces		0.25	0.5	0.75	1	1.5	2.5	4	6	10	16	
												
Cat. no. and quantity	In bag	DZ5CE002 10x100	DZ5CE005 10x100	DZ5CE007 10x100	DZ5CE010 10x100	DZ5CE015 10x100	DZ5CE025 10x100	DZ5CE042 10x100	DZ5CE062 1x100	DZ5CA102 1x100	DZ5CA162 1x100	
	In dispenser pack	-	AZ5CE005 5x200	AZ5CE007 5x200	AZ5CE010 5x200	AZ5CE015 5x200	AZ5CE025 5x100	-	-	-	-	
	In strip of 50	-	DZ5CEB005 10x50	DZ5CEB007 10x50	DZ5CEB010 10x50	DZ5CEB015 10x50	DZ5CEB025 10x50	-	-	-	-	
Colour		Yellow	White	Blue	Red	Black	Grey	Orange	Green	Brown	White	

Double end-pieces

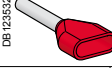
Conductor cross section (mm ²)		2 x 0.5	2 x 0.75	2 x 1	2 x 1.5	2 x 2.5
						
Cat. no. and quantity	In bag	AZ5DE005 1x1000	AZ5DE0071 1x1000	AZ5DE0101 1x1000	AZ5DE0151 1x1000	AZ5DE0255 1x500
	In dispenser pack	-	AZ5DE007 5x100	AZ5DE010 5x100	AZ5DE015 5x100	AZ5DE025 5x50
	Colour	White	Blue	Red	Black	Grey

Crimping pliers

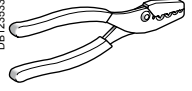
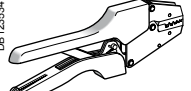
On cable types	0.5 to 16 mm ²	10 to 35 mm ²	0.25 to 6 mm ²	10 to 35 mm ²
				
Cat. no.	AT1PA2	AT1PA4	AT2PA5	AT2PA6

Connection to the outside of the switchboard

Connection Selection aid



Type of connection **Fast** Screw-on

Terminal bars, terminal blocks and earth bars

Fast connection			
Type	Phase-to-neutral terminal blocks or earth bar		Earth bar
	Example of composition		
Rating	90 A (to be formed)		160 A (to be formed)
Connection capacity	4 mm ²		36 (spring-loaded terminal)
	6 mm ²		24 (spring-loaded terminal)
	16 mm ²		3 (spring-loaded terminal)
	25 mm ²		1 (screw-on)
	35 mm ²		1 (screw-on)
Mounting	In Pragma Evolution enclosures		The bare bar is fastened by supplied screws on the upright of the Prisma enclosures The earth blocks are clipped onto the bare bar
Cat. no.	PRA90051 : support kit + PRA90050 : junction kit + PRA90047 : 10 blocks of 4x6 mm ² + PRA90046 : 5 blocks of 25 mm ²		PRA90051 : support kit + 2 x PRA90050 : junction kit + PRA90047 : 10 blocks of 4x6 mm ² + PRA90046 : 5 blocks of 25 mm ²

Screw connection																					
	Terminal bars				Phase-to-neutral terminal blocks or earth bar					Earth bar											
					Example of composition																
Rating	80 A		125 A		80 A					90 A (to be formed)		160 A (to be formed)		-							
Connection capacity	10 mm ²		2		3		5		7		2		4		8		11		16		
	16 mm ²		2		2		4		6		2		4		8		11		16		
	25 mm ²																				6
	35 mm ²				1		1		1												6
	50 mm ²																				1
Specific feature	Fastening by screws (1 M4 tapped hole)				Fastening: Clip-on to 12 x 2 mm flat bar Clip-on to rail (8 hole version only) By screws (8 hole version only) With dovetail (4 hole version only)					Mounting in Pragma Evolution enclosures		Fastening by supplied screws on the upright of the Prisma enclosures									
Cat. no.	14962	14963	14964	14965	13575	13576	13577	13578	13579	PRA90051 : support kit + PRA90050 : junction kit + PRA90045 : 2 blocks of 50 mm ² + 2 x PRA90046 : 5 blocks of 25 mm ²		PRA90051 : support kit + 2 x PRA90050 : junction kit + PRA90045 : 2 blocks of 50 mm ² + 2 x PRA90046 : 5 blocks of 25 mm ²		04200							

Connection to the outside of the switchboard

Terminal blocks

Fast connection			Conductor cross section									
			4 mm ²		6 mm ²		10 mm ²		16 mm ²			
Number of points			1 input, 1 output		1 input, 2 outputs		1 input, 1 output		1 input, 1 output			
Width			6 mm		6 mm		8 mm		12 mm			
Cat. no. and quantity	1 Terminal block	Grey	AB1 RRN435U2GR 100		AB1 RRN435U3GR 100		AB1 RRN635U2GR 50		AB1 RRN1035U2GR 50		AB1 RRN1635U2GR 50	
		Blue	AB1 RRN435U2BL 100		AB1 RRN435U3BL 100		AB1 RRN635U2BL 50		AB1 RRN1035U2BL 50		AB1 RRN1635U2BL 50	
		Green/ yellow	AB1 RRNTP435U2 100		AB1 RRNTP435U3 100		AB1 RRNTP635U2 50		AB1 RRNTP1035U2 50		AB1 RRNTP1635U2 50	
	2 Partition	AB1 RRNTPAC442 10		AB1 RRNTPAC443 100		AB1 RRNTPAC642 10		AB1 RRNTPAC1042 10		AB1 RRNTPAC1642 10		
		3 End cover	Grey	AB1 RRNAC442GR 10		AB1 RRNAC443GR 10		AB1 RRNAC643GR 10		AB1 RRNAC1042GR 10		AB1 RRNAC1642GR 10
	Blue		AB1 RRNAC442BL 10		AB1 RRNAC443BL 10		AB1 RRNAC643BL 10		AB1 RRNAC1042BL 10		AB1 RRNAC1642BL 10	
	4 Insulated terminal bar, 2-pole	AB1 RRAL42 10		AB1 RRAL42 10		AB1 RRNAL62 10		AB1 RRAL102 10		AB1 RRAL162 10		

Screw connection			Conductor cross section		
			35 mm ²	70 mm ²	150 mm ²
Number of points			1 input, 1 output	1 input, 1 output	1 input, 1 output
Width			16 mm	24 mm	28 mm
Cat. no. and quantity	1 Terminal block	Grey	AB1 VVN3535U 20	AB1 VVN7035U 20	AB1 VVN15035U 10
		Blue	AB1 VVN3535UBL 20	AB1 VVN7035UBL 20	AB1 VVN15035UBL 10
	2 Terminal bar, 2-point	AB1 ALN352 10 (insulated)	AB1 ALN702 10 (uninsulated)	AB1 ALN1502 10 (uninsulated)	

Accessories									
Clip-on terminal markers								Label	Plastic stop
Marking	Blank	1 to 10	11 to 20	21 to 30	31 to 40	41 to 50	AB1 S1	AB1 AB8P35	
	Width and Cat. no.	6 mm	AB1 BV6	AB1 B610	AB1 B620	AB1 B630	AB1 B640	AB1 B650	
8 mm		AB1 BV8	AB1 B810	AB1 B820	AB1 B830	AB1 B840	AB1 B850		
Quantity	6 mm	AB1 B660	AB1 B6670	AB1 B680	AB1 B690	AB1 B6100	-	Clip-on 4.5 x 8.3 mm	Screw-on
	8 mm	AB1 B860	AB1 B870	AB1 B880	AB1 B890	AB1 B8100	-		
	6 mm	L1	L2	L3	+ red	- blue	-		
	6 mm	AB1 B6L1	AB1 B6L2	AB1 B6L3	AB1 BV6RP	AB1 BV6BM	-		
Quantity	Set of 25							500	100

Wiring routing
Selection aid



Type of wiring routing

Cable troughs

Wiring bands with cover

Clamps

Cable troughs



RAL 9001 white									
Use		For Prisma Plus System G enclosures and cabinets							
Mounting		Horizontal 4 lengths of 450 mm		Vertical 18 lengths of 2 m		On door 30 lengths of 2 m			
Width		30 mm		60 mm		30 mm			
Height		60 mm		80 mm		30 mm			
Characteristics		Supplied with mounting brackets		-		Self-adhesive			
Cat. no.		04257		04267		04233			
Accessories									
Mounting bracket for Prisma Plus System G enclosure									
		Set of 12 horizontal cable trough mounting brackets		Set of 10 horizontal cable trough mounting brackets allowing alignment with a vertical cable trough		Set of 12 vertical cable trough mounting brackets			
Cat. no.		04255		04256		04265			
RAL 7030 grey									
Use		Universal 8 lengths of 2 m							
Width		25 mm		37.5 mm		50 mm		75 mm	
Height		25 mm		50 mm		50 mm		75 mm	
Cat. no.		NSYCD2M2525		NSYCD2M2550		NSYCD2M3750		NSYCD2M3775	
Cable trough bottom		NSYCD2M2525		NSYCD2M2550		NSYCD2M3750		NSYCD2M3775	
Cover		NSYCDC2M25		NSYCDC2M37		NSYCDC2M50		NSYCDC2M75	
NSYCD2M5050		NSYCD2M5075		NSYCD2M7550		NSYCD2M7575			
Accessories									
Set of 20 mounting brackets on pierced plate or on rail									
Cat. no.		NSYSPC							

Management of cables in the switchboard

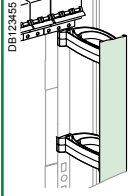
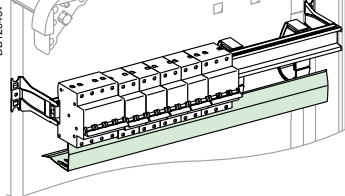

Wiring bands

Use				
For Prisma Plus System G enclosures and cabinets				
Mounting	Vertical		Horizontal	
				
Type	Wiring bands	Covers	Wiring bands	Covers
Quantity	Set of 12	2 x 1 m	Set of 12	4 x 430 mm
Cat. no.	04264	04263	04239	04243

Clamps

Identification clamps			
Pad size	20 x 9 mm	25 x 8 mm	23 x 13 mm
			
Width	2.5 mm	2.5 mm	4,8 mm
Length	110	100	220
Max. clamping dia.	18 mm	18 mm	43 mm
Quantity	100	100	100
Cat. no.	46220	46222	46225

Cable clamps

Width	2.5 mm			3.6 mm			4.8 mm		7.6 mm
									
Length (mm)	100	200	140	200	295	200	270	368	
Max. clamping dia.	18 mm	50 mm	33 mm	50 mm	76 mm	50 mm	73 mm	102 mm	
Quantity	1000	1000	1000	1000	1000	1000	1000	1000	
Cat. no.	Standard (colourless)	NSYLZ25100	NSYLZ25200	NSYLZ35140	NSYLZ35200	NSYLZ35290	NSYLZ48200	NSYLZ48280	NSYLZ76380
	UV resistant (black)	NSYLN25100	NSYLN25200	NSYLN35140	NSYLN35200	NSYLN35290	NSYLN48200	NSYLN48280	NSYLN76380

Accessories for clamps

Type	Bases	
		
Characteristics	Self-adhesive or screw-on (set of 100)	
	19 x 19 x 6 mm	26.5 x 26.5 x 8 mm
	For clamp of max. width 3.6 mm	For clamp of max. width 4.8 mm
Cat. no.	NSYMB3A	NSYMB4A

Comb busbars

Accessories

1P+N and 3P+N comb busbar

043832



Function

The comb busbars make it easier to install Schneider Electric products.

- Supplied with 2 side plates, IP 2
- Outgoing feeders can be marked
- Cutting markings on the copper bars and the insulating material
- Self-extinguishing insulating material, colour RAL 7016
- The teeth left on standby can be isolated by tooth cover end-pieces

Wiring diagram

DB1105874

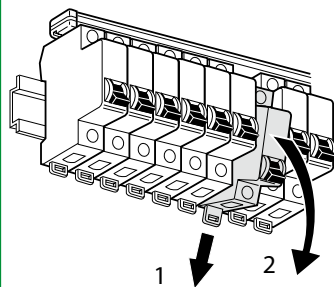

Comb busbars allow dismantability (1-2)

DB1105875

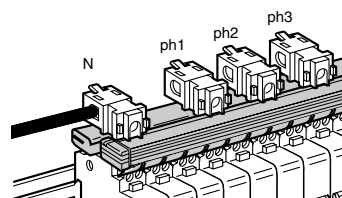

Use

- Power supply via semi-rigid cable directly in the cage of the device:
 - cross section 16 mm² for DPN
 - cross section 10 mm² for STI

	1P+N	1P+N	3P+N
Catalogue numbers	14880	14890	14899
Number of 9 mm modules	26	48	48
Set of	1	2	2

Suitable for the following devices:

STI	■	■	–
DPN	■	■	■



Technical specifications

Voltage rating (Ue)	250 V
Acceptable current at 40°C	80 A with 1 central power supply point 100 A with 2 power supply points
Max. current per feeder	63 A
Resistance to short-circuit currents	Compatible with the breaking capacity of Schneider Electric modular circuit breakers

Connection comb busbars

for iC60, iLD, iSW-NA, C120, NG125, STI,
DPN (cont.)

Accessories

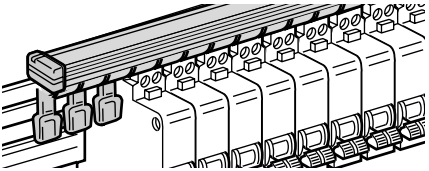
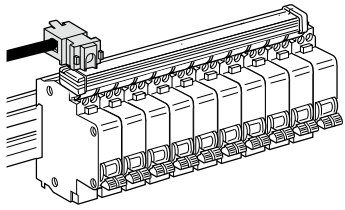
Side plate		Tooth cover end-piece		Insulated connector
				<p>030921d</p> 
				<ul style="list-style-type: none"> Compatible with all Schneider Electric comb busbars Clip onto the comb busbar's insulating material, which gives them very great stability Receive clip-on markers allowing circuit identification
<p>DB105877</p> 	<p>DB105877</p> 	<p>DB105876</p> 		
				<ul style="list-style-type: none"> For 25 mm² semi-rigid cable
1P+N	3P+N	1P+N, 3P+N		
14886	14887	14898		14885
-	-	-		-
40	40	40		4
■	■	■		■
■	■	■		■
-	-	-		-
-	-	-		-
-	-	-		-
-	-	-		-



Function

The comb busbars make it easier to install Schneider Electric products.

- Supplied with 2 side plates, IP 2
- Outgoing feeders can be marked
- Cutting markings on the copper bars and the insulating material
- Self-extinguishing insulating material, colour RAL 7016
- The teeth left on standby can be isolated by tooth cover end-pieces

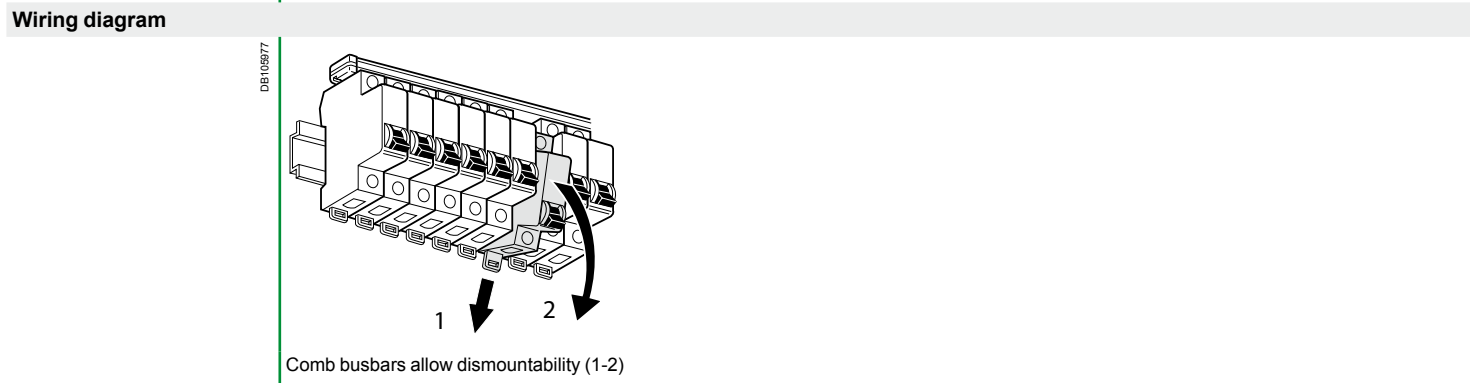

Use

<ul style="list-style-type: none"> ■ Power supply via semi-rigid cable directly in the cage of the device: <ul style="list-style-type: none"> □ cross section 25 mm² for iC60 and iID (all ratings) □ cross section 10 mm² for STI 	Direct power supply on the circuit-breaker terminal: maximum 50 mm ² rigid																				
<table border="1"> <tr> <td>1P</td><td>2P</td><td>3P</td><td>4P</td> <td>1P</td><td>2P</td><td>3P</td><td>4P</td> </tr> <tr> <td>14881</td><td>14891</td><td>14882</td><td>14892</td> <td>14883</td><td>14893</td><td>14884</td><td>14894</td> <td>14811</td><td>14812</td><td>14813</td><td>14814</td> </tr> </table>	1P	2P	3P	4P	1P	2P	3P	4P	14881	14891	14882	14892	14883	14893	14884	14894	14811	14812	14813	14814	
1P	2P	3P	4P	1P	2P	3P	4P														
14881	14891	14882	14892	14883	14893	14884	14894	14811	14812	14813	14814										
Number of 9 mm modules	24	48	24	48	24	48	24	48	L = 430 mm, 16 poles of 27 mm	L = 430 mm, 16 poles of 27 mm	L = 405 mm, 15 poles of 27 mm	L = 430 mm, 16 poles of 27 mm									
Set of	1	2	1	2	1	2	1	2	1												

Suitable for the following devices:

STI	■	■	■	■	■	■	■	■	-	-	-	-
iC60	■	■	■	■	■	■	■	■	-	-	-	-
iID, iSW-NA	■	■	■	■	■	■	■	■	-	-	-	-
C120	-	-	-	-	-	-	-	-	■	■	■	■
NG125 ≤ 63 A	-	-	-	-	-	-	-	-	■	■	■	■



Technical specifications

Voltage rating (Ue)	500 V	500 V
Acceptable current at 40°C	80 A with 1 central power supply point 100 A with 2 power supply points	125 A
Max. current per feeder	-	63 A
Resistance to short-circuit currents	Compatible with the breaking capacity of Schneider Electric modular circuit breakers	Compatible with the breaking capacity of modular circuit breakers

Connection comb busbars

for iC60, iLD, iSW-NA, C120, NG125, STI,
DPN (cont.)

Accessories

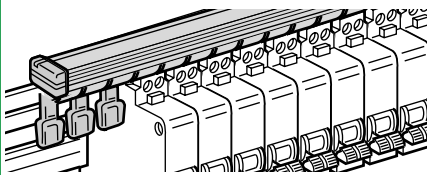
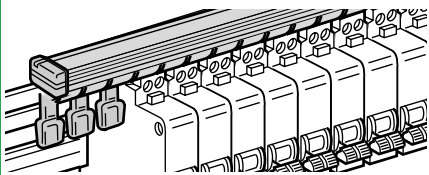
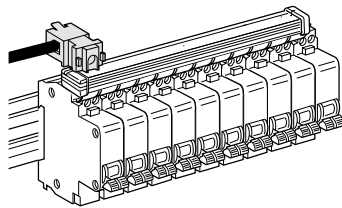
Side plate		Tooth cover end-piece		Insulated connector	
					
				<ul style="list-style-type: none"> Compatible with all Schneider Electric comb busbars Clip onto the comb busbar's insulating material, which gives them very great stability Receive clip-on markers allowing circuit identification 	
					
				<ul style="list-style-type: none"> For 25 mm² semi-rigid cable 	<ul style="list-style-type: none"> For 35 mm² semi-rigid cable
1P, 2P	3P, 4P	1P, 2P, 3P, 4P			
14886	14887	14888	14818	14885	26998
40	40	40	20	4	1
■	■	■	-	■	-
■	■	■	-	■	■
■	■	■	-	■	■
-	-	-	■	-	-
-	-	-	■	-	-
-	-	-	-	-	-
-	-	-	-	-	-
-	-	-	-	-	-
-	-	-	-	-	-



IEC/EN 60947-7-1.
IEC/EN 61439-2.

Description

- Distribloc 63 A is a four pole splitter block installable on a standard DIN rail.
- Outgoing feeders are connected at the front, without screws, in spring terminals. The contact pressure of the cable is independent of the operator.
- The spring contact pressure adapts automatically to the cross section of the conductor. It is independent of the operator.

Advantages

- Very fast connection.
- Very simple phase rebalancing.
- In the event of an extension to or modification of the switchboard, connection is very easy.
- The appearance of its front panel (45 mm front tip) enables it to fit in on a row perfectly, alongside modular devices.

Technical data

Main characteristics		
Cat. no	Distribution through the top	04040
	Distribution through the bottom	04041
According to IEC/EN 60947-7-1		
Degree of protection		IP20
Rated insulation voltage (Ui)		500 V AC
Voltage rating (Ue)		440 V AC
Rated impulse withstand voltage (Uimp)		6 kV
Short-circuit current withstand		Up to breaking capacity of Schneider Electric outgoing circuit breakers, even when reinforced by cascading implementation
Reference temperature		40°C
Rated current at 40°C (In)		63 A
Operating frequency		50/60 Hz
Width in 9-mm modules		8

PB104489-40



DB122826

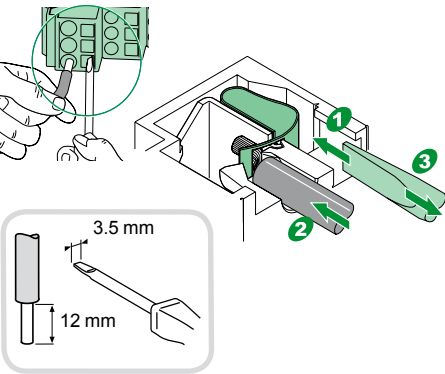

PB104500-80

Power supply

- Four-pole tunnel terminals with screw clamping.
- The tunnel terminals are located to facilitate the insertion of cables and clamping by screws.
- A single cable per connection point:
 - flexible from 4 to 16 mm²
 - rigid from 6 to 25 mm².

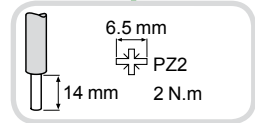

Installation

- Clip-on mounting on modular rail.
- Width occupied: 8x9-mm modules.

Distribution

- 3 outgoing feeders connected by flexible or rigid cables of cross section 1 to 6 mm².
- 2 rows of terminals:
 - 12 connection points for phases (L1, L2, L3)
 - 12 connection points for neutral.
- A single cable per connection point: flexible (without ferrule) or rigid from 1 to 6 mm².
- Reliable, maintenance-free (tightness guaranteed over time).
- Insensitive to vibrations and thermal variations.

Distribloc 63 A splitter block (cont.)

Additional characteristics

According to IEC/EN 60947-7-1

Rated cross section	16 mm ²
Rated connecting capacity	10-16-25 mm ²
Pollution degree	3
Storage temperature	-40°C to +85°C

According to IEC/EN 61439-2

Operating temperature	-25°C to +60°C
Colour	RAL 7016, RAL 9003

Installation

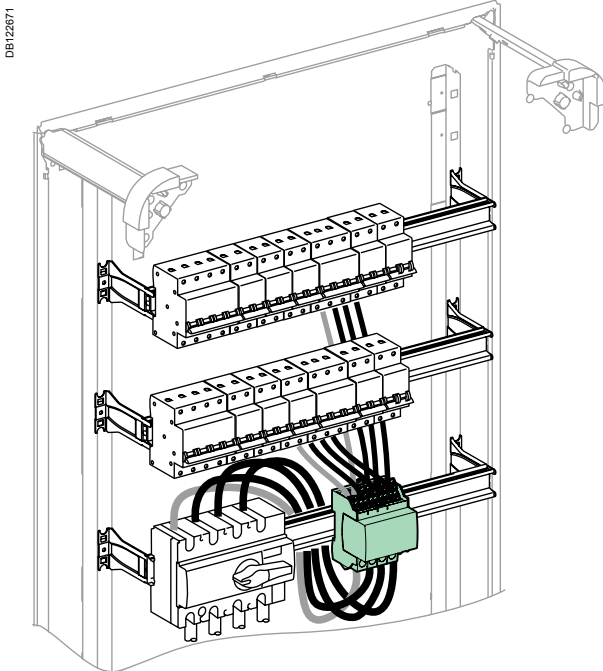

Distribution through the bottom.

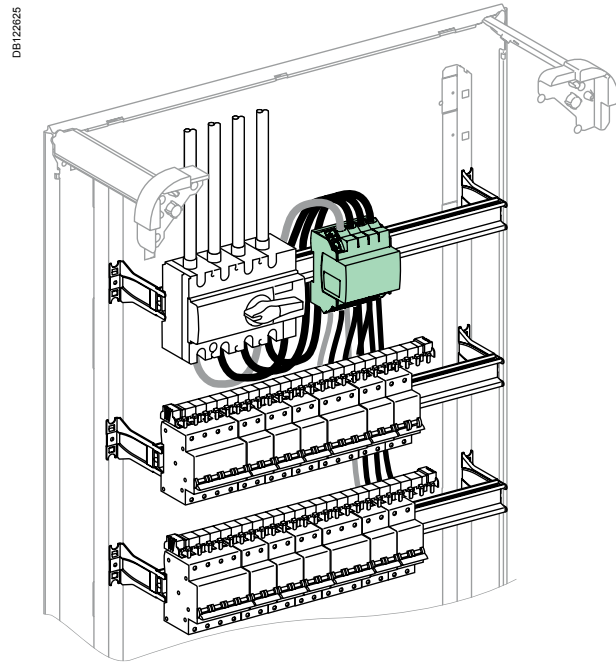

Distribution through the top.

Weight (g)

Splitter block

Type

Distribloc	290
------------	-----

Dimensions (mm)

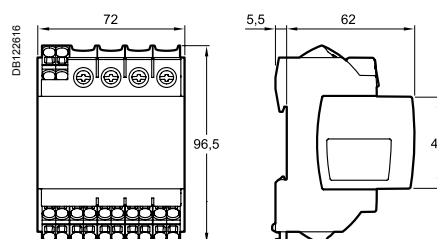

PB104507-35



IEC/EN 60947-7-1.
IEC/EN 61439-2.

Description

- Multiclip 80 A is a four-pole splitter block 24 modules wide installable on a standard DIN rail.
- Outgoing feeders are connected at the front, without screws, in spring terminals.
- The spring contact pressure adapts automatically to the cross section of the conductor. It is independent of the operator.
- Supplied with 12 black and 12 blue pre-stripped 6 mm² cables.

Advantages

- Very fast connection.
- Very simple phase rebalancing.
- In the event of an extension to or modification of the switchboard, connection is very easy.
- Compatible with inter-rows of 150 mm.

Technical data

Main characteristics	
Cat. no	04000
According to IEC/EN 60947-7-1	
Rated current at 40°C (I _n)	80 A
Maximum operated voltage (U _e)	440 V AC
Operating frequency	50/60 Hz
Rated insulation voltage (U _i)	500 V AC
Pollution degree	3
Rated impulse withstand voltage (U _{imp})	6 kV
Degree of protection	IP20
Short-circuit current withstand	Up to breaking capacity of Schneider Electric outgoing circuit breakers, even when reinforced by cascading implementation
Width in 9-mm modules	48

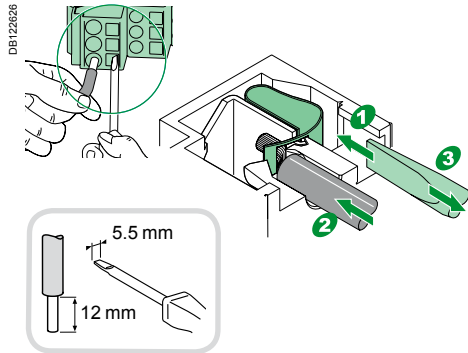

Power supply

- Four-pole tunnel terminals with screw clamping.
- The tunnel terminals are located to facilitate the insertion of cables and clamping by screws.
- One cable per connection point:
 - flexible from 6 to 25 mm²
 - rigid from 10 to 35 mm².

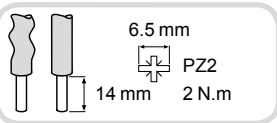

Installation

- Clip-on mounted Pragma and Prisma DIN rails.
- Screwed on all other symmetric rail.



PB104501-45

Distribution

- Connection to spring terminals through the front.
- 2 rows of terminals:
 - 18 connection points for phases (L1, L2, L3)
 - 18 connection points for neutral.
- A single cable per connection point: flexible (without ferrule) or rigid from 1 to 6 mm².
- Maintenance-free (tightness guaranteed over time). Insensitive to vibrations and thermal variations.

Multiclip 80 A splitter block (cont.)

PB1 (14495-50)



Additional characteristics	
According to IEC/EN 61439-2	
Operating temperature	-25°C to +60°C
Storage temperature	-40°C to +85°C
Colour	RAL 7016

Installation

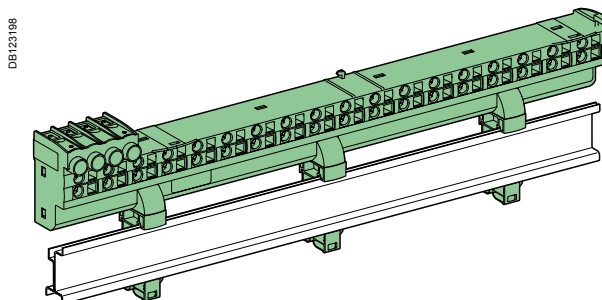

On Pragma and Prisma rails

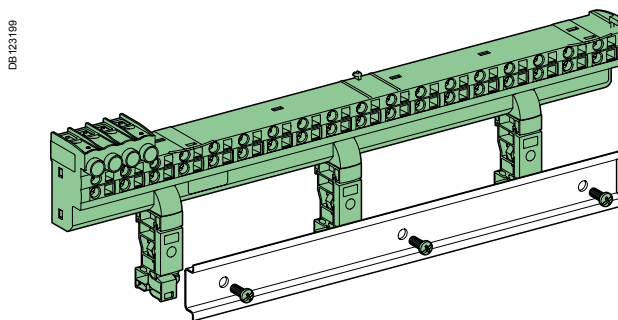

On other symmetric rails

Weight (g)

Splitter block	
Type	
Multiclip	640

Dimensions (mm)

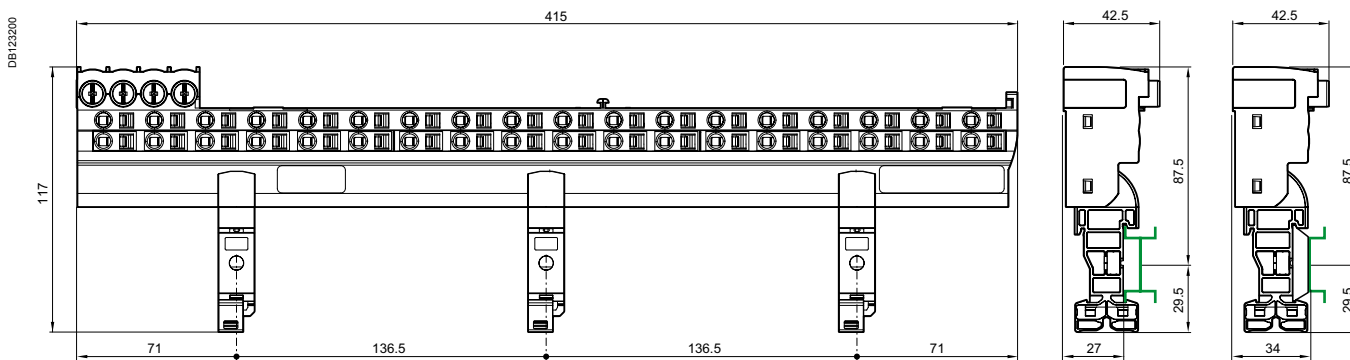



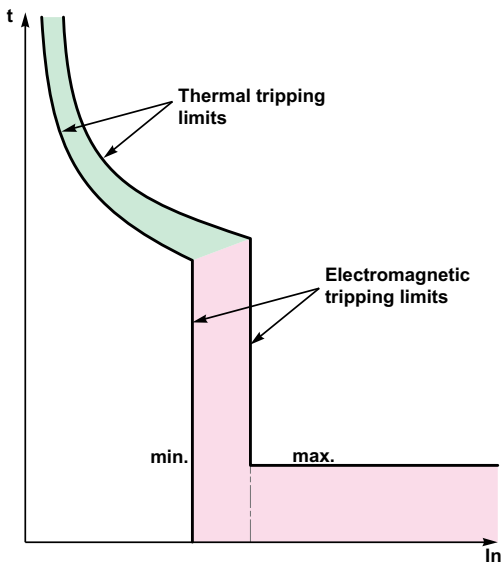

The following curves show the total fault current breaking time, depending on its amperage. For example: based on the curve on page 3, an iC60 circuit breaker of curve C, 20 A rating, will interrupt a current of 100 A (5 times the rated current I_n) in:

- 2 seconds at least
- 7 seconds at most.

The circuit breakers' tripping curves consist of two parts:

- tripping of overload protection (thermal tripping device): the higher the current, the shorter the tripping time
- tripping of short-circuit protection (magnetic tripping device): if the current exceeds the threshold of this protection device, the breaking time is less than 10 milliseconds. For short-circuit currents exceeding 20 times the rated current, the time-current curves do not give a sufficiently precise representation. The breaking of high short-circuit currents is characterized by the current limiting curves, in peak current and in energy. The total breaking time can be estimated at 5 times the value of the ratio $(I^2t)/(\hat{I})^2$.

Verification of the discrimination between two circuit breakers

By superimposing the curve of a circuit breaker on that of the circuit breaker installed upstream, one can check whether this combination will be discriminating in cases of overload (discrimination for all current values, up to the magnetic threshold of the upstream circuit breaker). This verification is useful when one of the two circuit breakers has adjustable thresholds; for fixed-threshold devices, this information is provided directly by the discrimination tables.

To check discrimination on short circuit, the energy characteristics of the two devices must be compared.

iC60N/H/L ratings up to 4 A

Curve B

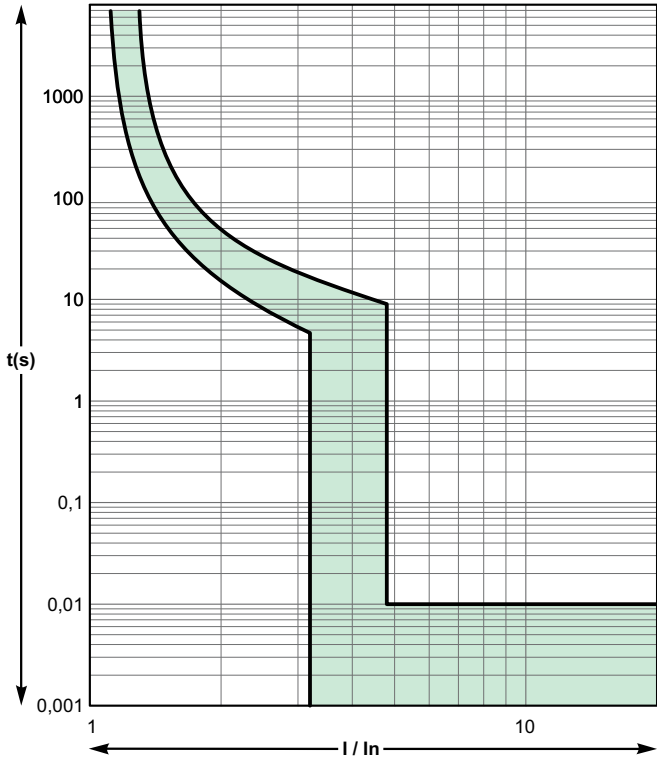

Curve C

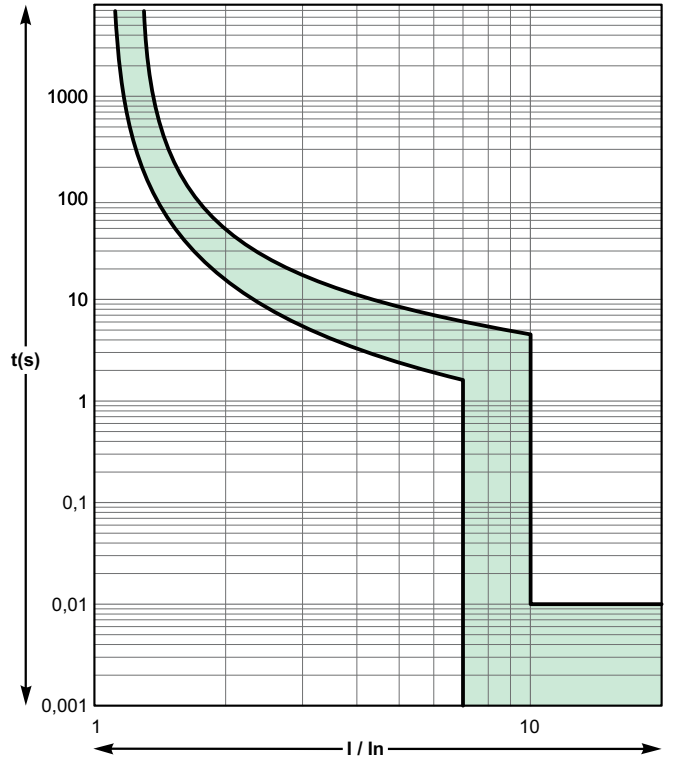

Curve D

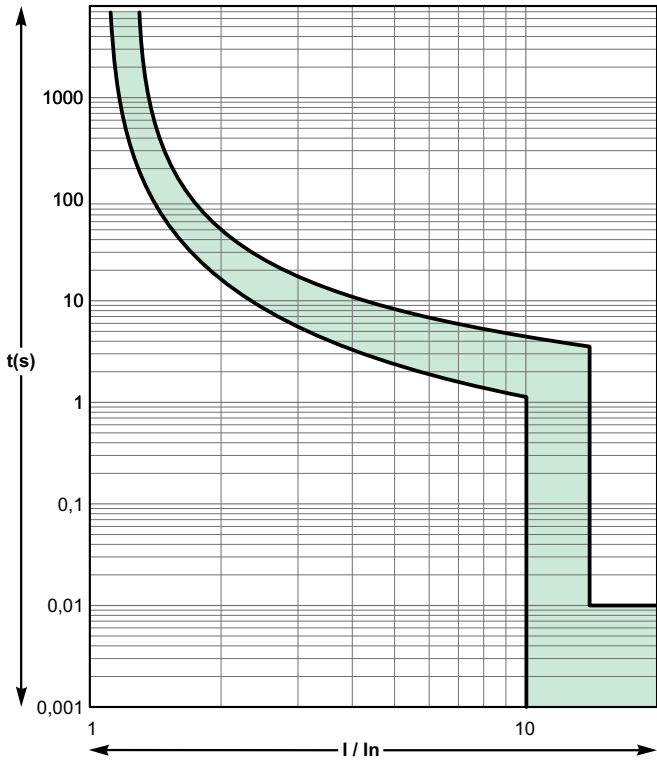

Tripping times (min, max) at an ambient temperature of 30 °C (standards IEC/EN 60898).

iC60N/H/L ratings 6 to 63 A

Curve B

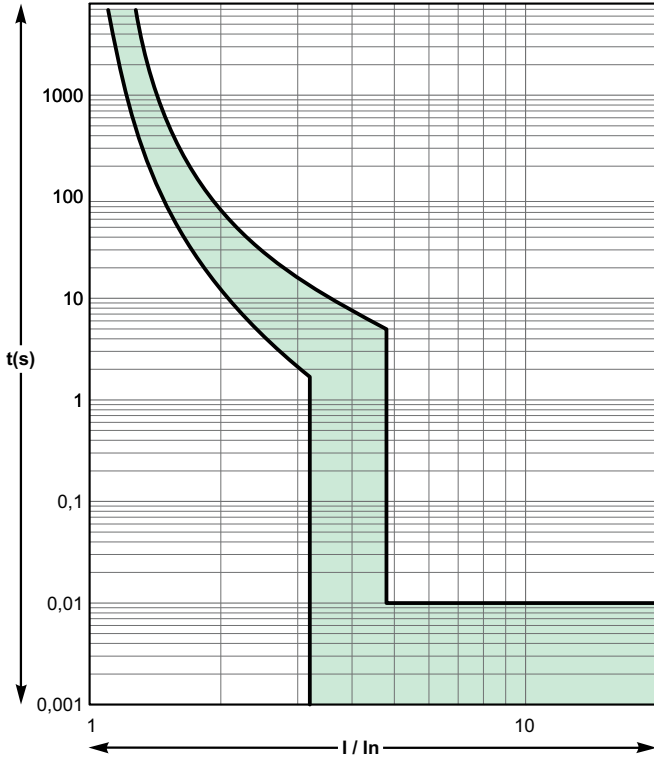

Curve C

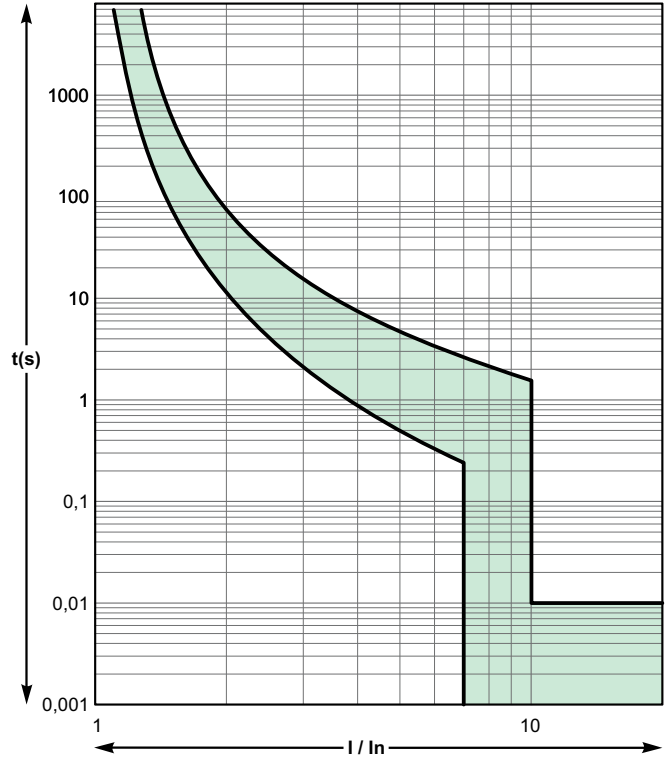

Curve D

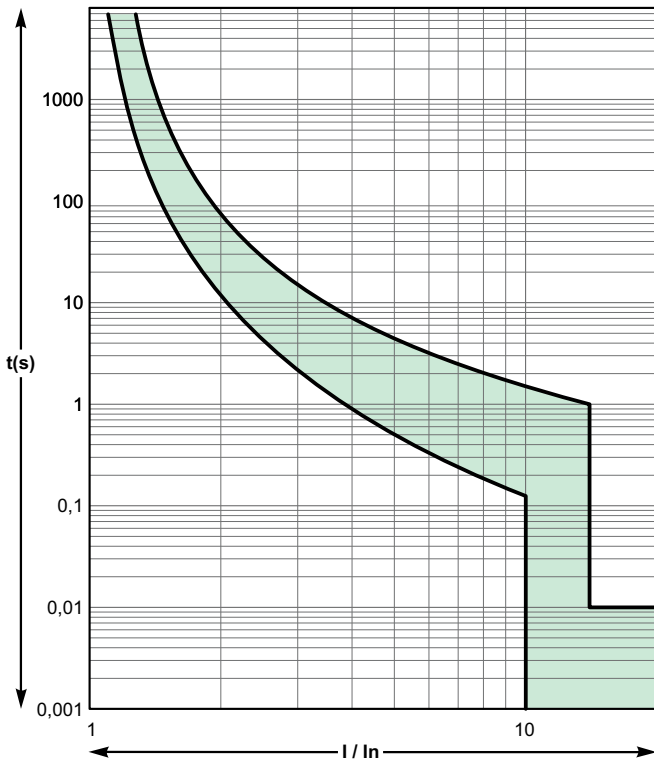

Tripping times (min, max) at an ambient temperature of 30 °C (standards IEC/EN 60898).

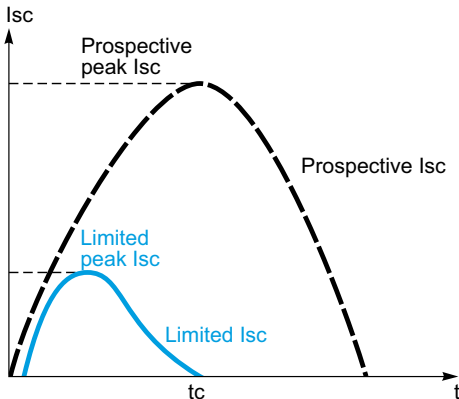

Prospective current and real limit current.

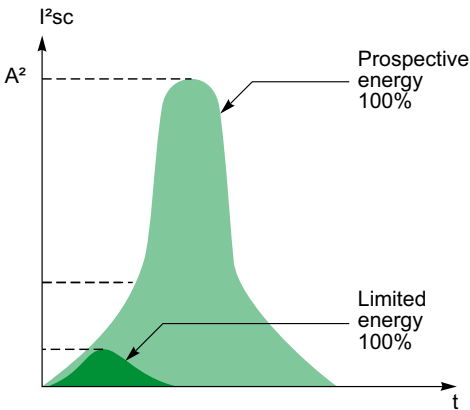

Definition

The limiting capacity of a circuit breaker is its ability to lessen the effects of a short circuit on an electrical installation by reducing the current amplitude and the dissipated power.

Benefits of limiting

Long installation service life

Thermal effects

Lower temperature rise at the conductor level, hence increased service life for cables and all components that are not self-protected (e.g. switches, contactors, etc.)

Mechanical effects

Lower electrodynamic repulsion forces, hence less risk of deformation or breakage of electrical contacts and busbars.

Electromagnetic effects

Less interference on sensitive equipment located in the vicinity of an electric circuit.

Savings through cascading

Cascading is a technique derived directly from current limiting: downstream of a current-limiting circuit breaker it is possible to use circuit breakers of breaking capacity lower than the prospective short-circuit current (in line with the cascading tables on page XXXX). The breaking capacity is heightened thanks to current limiting by the upstream device. Substantial savings can be achieved in this way on switchgear and enclosures.

Discrimination of protection devices

The circuit breakers' current limiting capacity improves discrimination with the protection devices located upstream: this is because the required energy passing through the upstream protection device is greatly reduced and can be not enough to cause it to trip. Discrimination can thus be natural without having to install a time-delayed protection device upstream.

Acti9 circuit breaker current limiting

Profiting from Schneider Electric's experience and expertise in the field of short-circuit current breaking, the circuit breakers of the Acti9 range have a top-level current limiting characteristic for modular devices.

This assures them of optimal protection of the entire power distribution system.

Compact NSX circuit breaker current limiting

Ics = 100 % Icu

The exceptional current limiting capacity of Compact NSX circuit breakers greatly attenuates the stresses caused by the fault current in the device.

The result is a significant increase in breaking performance.

In particular, the service breaking capacity Ics reaches 100% of Icu.

This performance, defined by the IEC 947-2 standard, is guaranteed following tests which involve:

- cutting off a fault current equal to 100% of Icu three times in a row
- then checking that the device operates normally:
 - it conducts its rated current without abnormal temperature rise;
 - the protection device operates within the limits authorized by the standard;
 - the suitability for isolation is ensured.

Representation: Current limiting curves

The current limiting capacity of a circuit breaker is reflected by 2 curves which give, as a function of the prospective short-circuit current (current which would flow in the absence of a protection device):

- the real peak current (limited)
- the thermal stress (in A²s), this value, multiplied by the resistance of any element through which the short-circuit current passes, gives the power dissipated by this element.

The straight line "10 ms" representing the energy A²s of a prospective short-circuit current of a half-period (10 ms) indicates the energy that would be dissipated by the short-circuit current in the absence of limiting by the protection device (see example 2).

Example 1

What is the peak value of a prospective short-circuit current of 150 kA rms (i.e. 330 kA) limited by an NSX250L device upstream?

➤ The peak value of the prospective short-circuit current is: 150 kA x √2 : 210 kA.

➤ As shown in the graph on page XXX, the Compact NSX250L circuit breaker reduces this value to: 30 kA.

Example 2

What is the energy limited by an iC60N 25 A circuit breaker for a prospective short-circuit current of 10 kA rms. What is the quality of current limiting?

➤ as shown in the graph opposite:

- this short-circuit current (10 kA rms) is likely to dissipate up to 1,000 kA²s
- the iC60N circuit breaker reduces this thermal stress to: 45 kA²s, which is 22 times less.

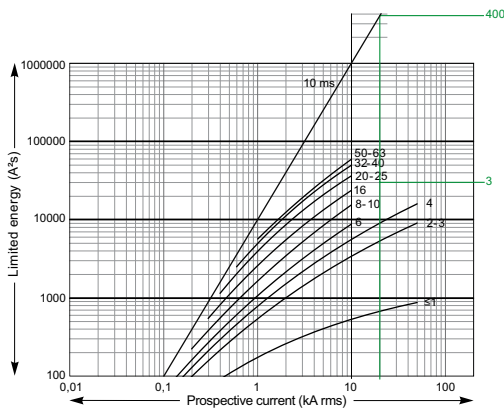

Example of use: Stresses acceptable by the cables

The following table shows the thermal stresses acceptable by the cables depending on their insulation, their composition (Cu or Al) and their cross section. Cross-section values are expressed in mm² and stresses in A²s.

S (mm ²)		1.5	2.5	4	6	10
PVC	Cu	2.97 10 ⁴	8.26 10 ⁴	2.12 10 ⁵	4.76 10 ⁵	1.32 10 ⁶
	Al					5.41 10 ⁵
PRC	Cu	4.10 10 ⁴	1.39 10 ⁵	2.92 10 ⁵	6.56 10 ⁵	1.82 10 ⁶
	Al					7.52 10 ⁵
S (mm ²)		16	25	35	50	
PVC	Cu	3.4 10 ⁶	8.26 10 ⁶	1.62 10 ⁷	3.21 10 ⁷	
	Al	1.39 10 ⁶	3.38 10 ⁶	6.64 10 ⁶	1.35 10 ⁷	
PRC	Cu	4.69 10 ⁶	1.39 10 ⁷	2.23 10 ⁷	4.56 10 ⁷	
	Al	1.93 10 ⁶	4.70 10 ⁶	9.23 10 ⁶	1.88 10 ⁷	

Example

Is a Cu/PVC cable of cross section 10 mm² protected by a Compact NSX160F device?

The above table shows that the acceptable stress is 1.32 x 10⁶ A²s. Any short-circuit current at the point where a Compact NSX160F device (I_{cu} = 36 kA) is installed will be limited, with a thermal stress of less than 6 x 10⁵ A²s. (Curve on page XX). The cable is therefore always protected up to the breaking capacity of the circuit breaker.

Limitation curves for 230 V single-phase or 400 V three-phase network (TN or TT earthing system)

iC60N

1P / 3P / 4P circuit breakers

Peak current

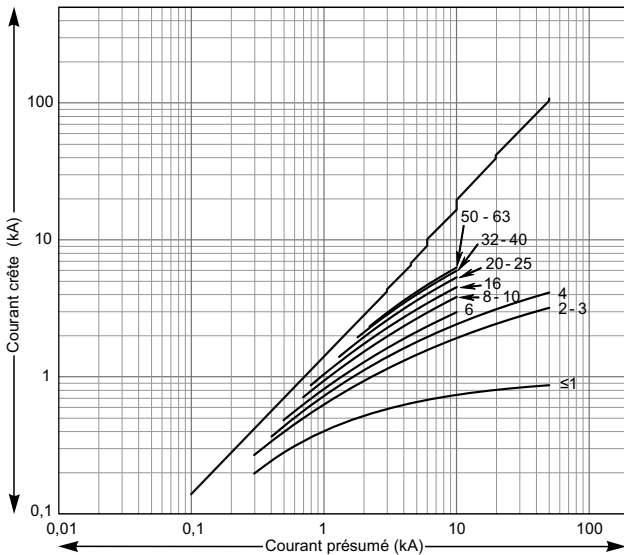

Thermal stress

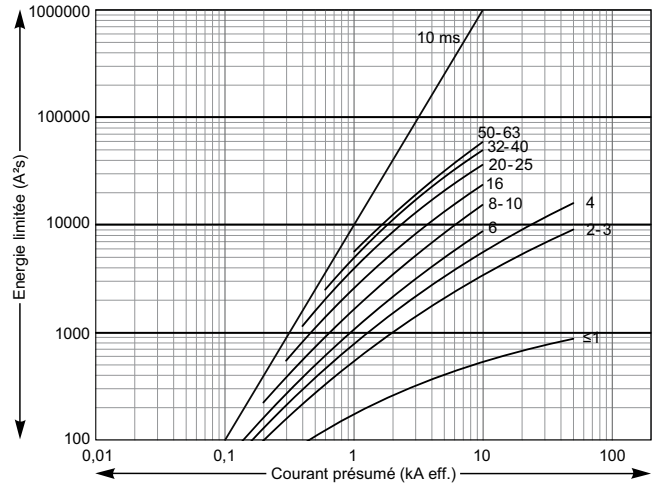

1P+N / 2P circuit breakers

Peak current

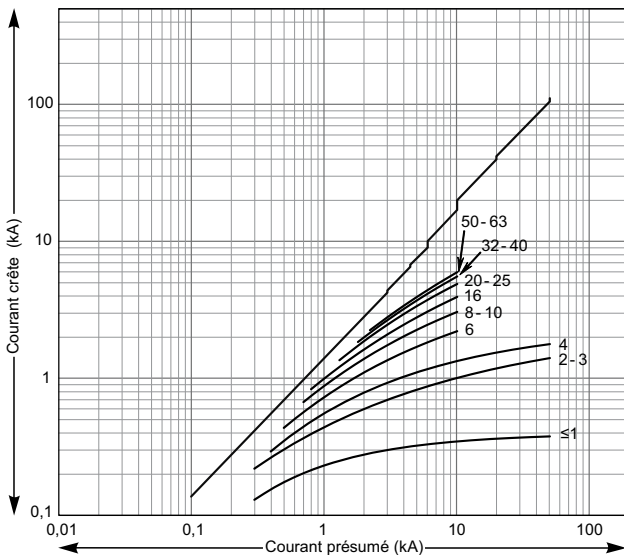

Thermal stress

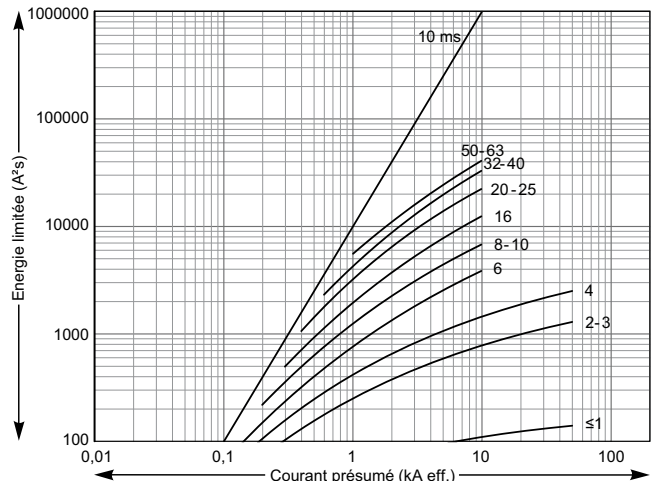

Note: these values are also the limitation values obtained with an iC60N three- or four-pole circuit breaker operating on a 230 V phase-to-phase network.

IC60H

1P / 3P / 4P circuit breakers

Peak current

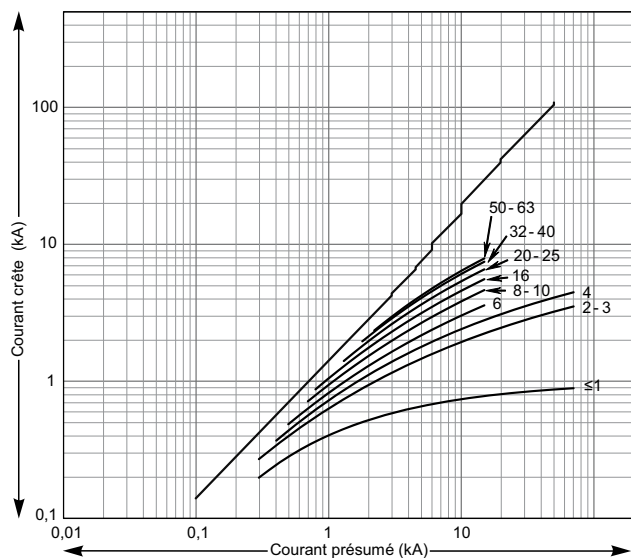

Thermal stress

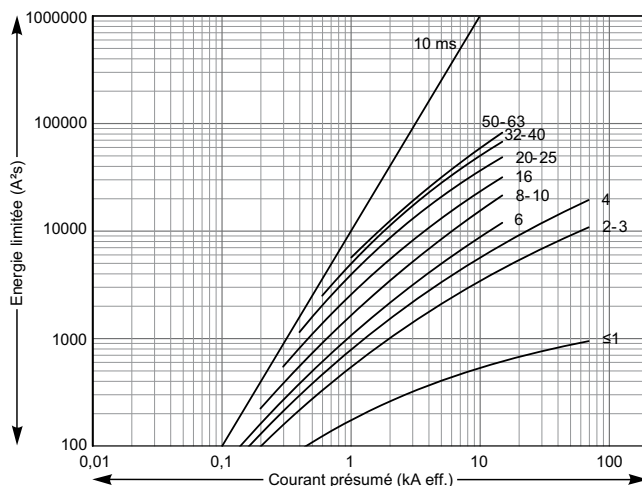

1P+N / 2P circuit breakers

Peak current

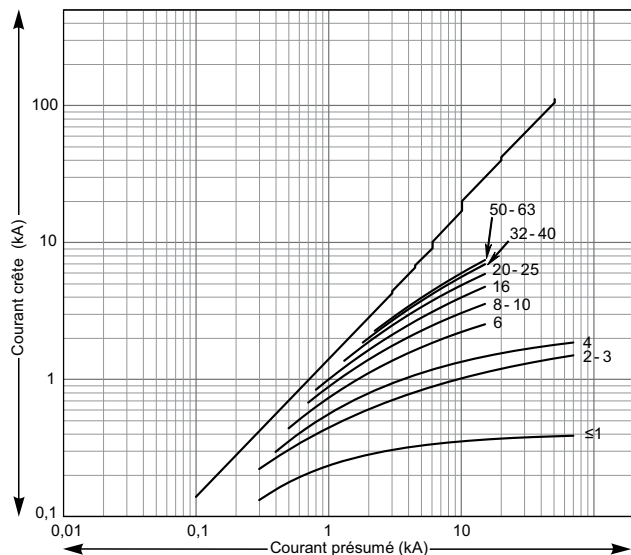

Thermal stress

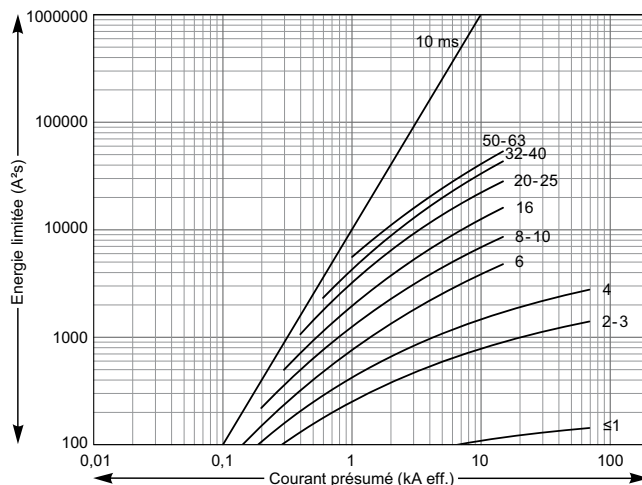

Note: these values are also the limitation values obtained with an IC60H three- or four-pole circuit breaker operating on a 230 V phase-to-phase network.

iC60L

1P / 3P / 4P circuit breakers Peak current

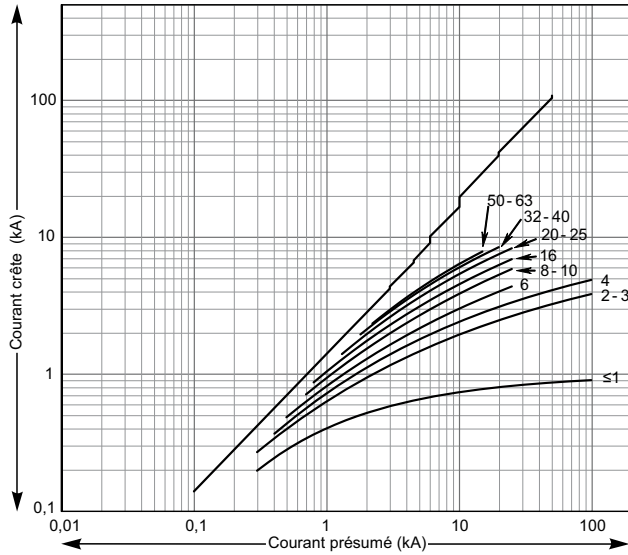

Thermal stress

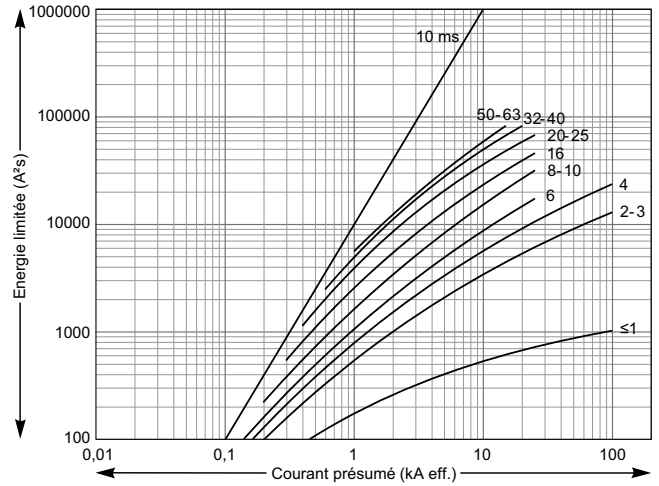

1P+N / 2P circuit breakers Peak current

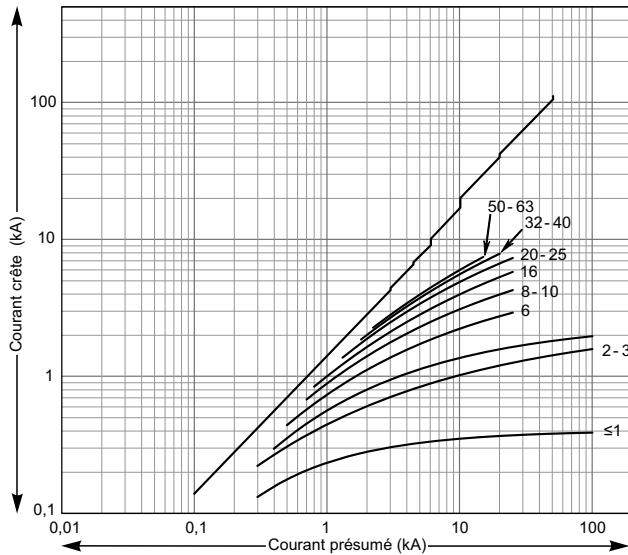



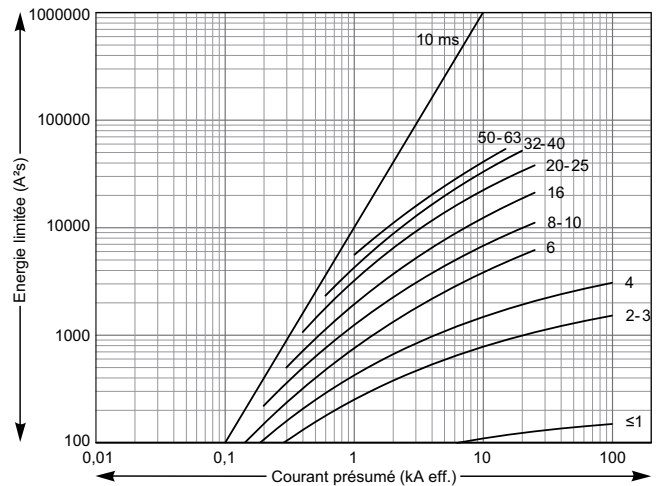

Thermal stress

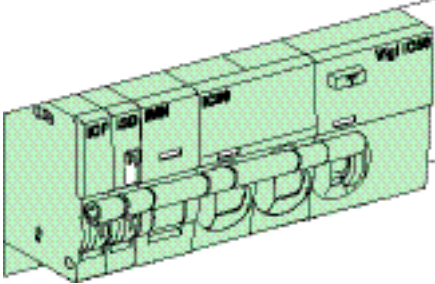
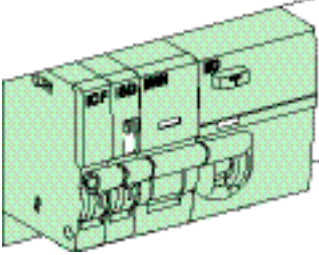
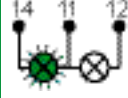
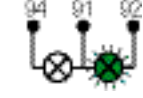
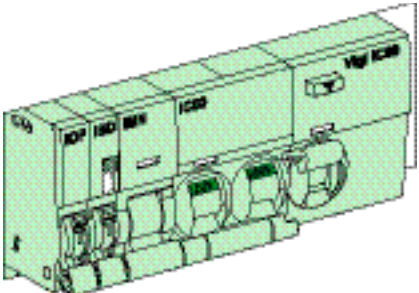
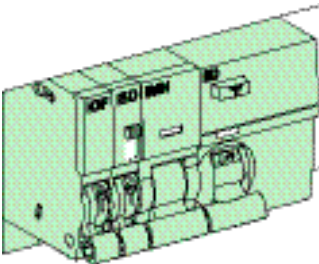

Note: these values are also the limitation values obtained with an iC60L three- or four-pole circuit breaker operating on a 230 V phase-to-phase network.

Auxiliary indicating contacts for Acti9 protective devices

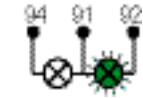
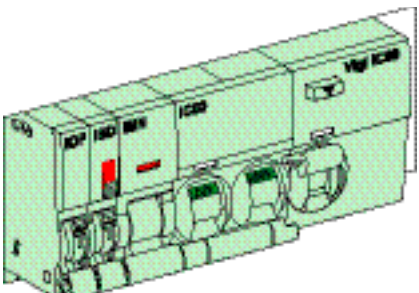
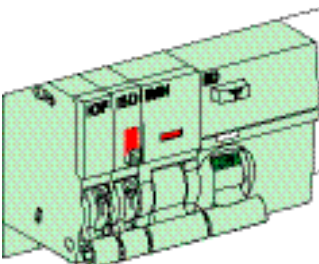
Table showing state of auxiliary contacts according to the main device and the type of fault.

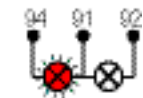
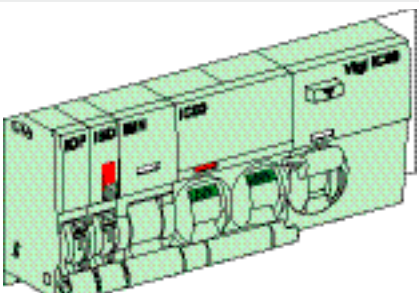
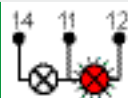
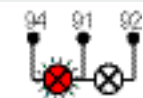
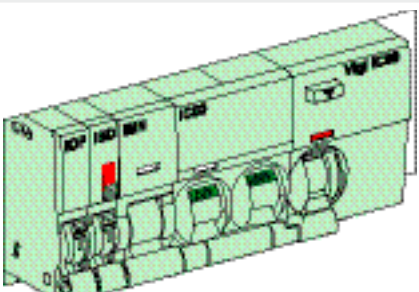
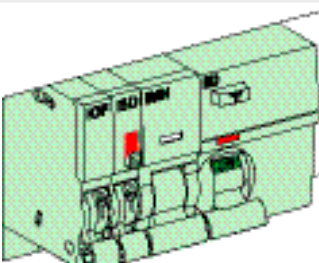
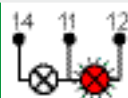
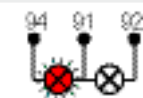
Functions and use	Main device		Auxiliary contacts	
	Circuit breaker	Residual current circuit breaker	OF	SD
Closed	 <p>DB123286</p>	 <p>DB123289</p>	 <p>DB123292</p>	
Manually opened	 <p>DB123277</p>	 <p>DB123279</p>	 <p>DB123290</p>	
Tripped by release auxiliary (iMN, iMX)	 <p>DB123279</p>	 <p>DB123280</p>	 <p>DB123291</p>	
Tripped upon overload or short circuit	 <p>DB123285</p>	<p>—</p>	 <p>DB123291</p>	
Tripped upon earth fault	 <p>DB123286</p>	 <p>DB123287</p>	 <p>DB123291</p>	

Auxiliary indicating contacts for Acti9 protective devices (cont.)

Function

RESET (SD contact)

When the main device is tripped and the fault has been eliminated, it is possible to switch the SD contact manually, via the "RESET" button on the front panel. The unit is then in "device opened manually" configuration.

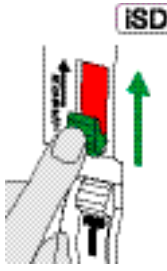
	iOF	iSD	iOF/SD+OF
	-	■	■ iSD only

TEST (SD or OF contact)

When the main device is opened or tripped, the TEST button can be used to check the satisfactory operation of the indicating circuit by simulating operation of the main device. This operation also modifies the position of the indicator on the front panel of the iSD auxiliary.

On the double contact (iOF/SD+OF), this function can be implemented only for the SD indicating circuit.

	iOF	iSD	iOF/SD+OF
	■	■	■

iOF/SD+OF double contact

Change of function of the second contact from OF to SD.

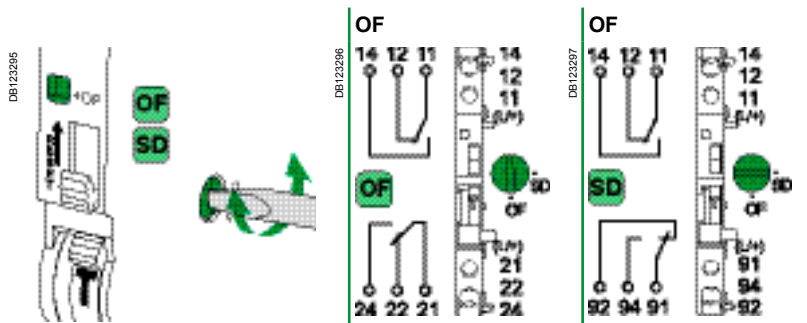

Auxiliary indicating contacts for Acti9 protective devices (cont.)

Technical data

Main characteristics

According to IEC 60947-5-1

Insulation voltage (Ui)	400 V AC		
Degree of pollution	3		
Rated impulse withstand voltage (Uimp)	4 kV (6 kV relative to the associated protective device)		
Current rating (A)	Min.	24 V, 10 mA	
	Max.	AC12 415 V AC	3 A
		AC12 ≤ 240 V AC	6 A
		DC12 130 V DC	1 A
		DC12 60 V DC	1.5 A
		DC12 48 V DC	2 A
DC12 24 V DC	6 A		

Additional characteristics

Degree of protection (IEC 60529)	Device only	IP20
	Device in a modular enclosure	IP40
Endurance (O-C)	Electrical	20,000 cycles
	Insulation class II	
Overvoltage category (IEC 60364)	III	
Short-circuit resistance	1 kA	
Rating of device for auxiliary contact protection against short circuits	Circuit breaker	iC60 - C curve - 6 A
	Fuse	6 A, 500 V Gg type 10.3 x 38 mm
Storage temperature	-40°C to +85°C	
Operating temperature	-35°C to +70°C	

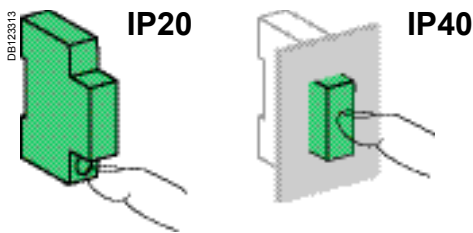

"Low-level" indication

For the control of low-level circuits (inputs of PLCs, sensors/actuators, etc.), the RBN relay can transmit the signals delivered by the circuit breakers' auxiliary contacts.

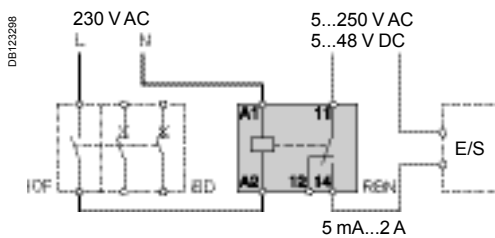

RBN relay

Type	Voltage (Ue)	Current rating (Ie)
Inputs (A1, A2)	230 V AC, 50...60 Hz	-
Outputs (11 and 12, 11 and 14)	5...250 V AC	5 mA...2 A
	5...48 V DC	

Auxiliary trip units for Acti9 protective devices

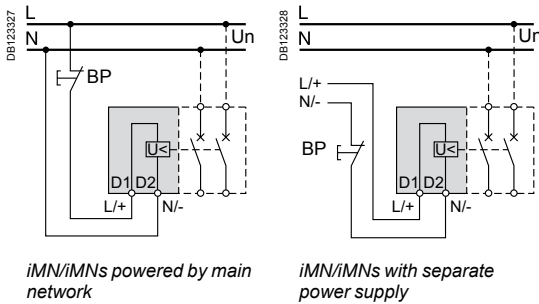

iMN, iMNs: undervoltage release units

Function

- Tripping of the associated protective device, when the voltage across its terminals falls:
 - either by opening the control circuit (e.g. push-button),
 - or by lowering the supply voltage.
- Resetting of the protective device is possible only after the voltage across the terminals of the auxiliary has returned to its nominal value.
- The MNs undervoltage release does not perform tripping in the event of a voltage drop lasting less than 200 ms.
- A locking push-button control allows the circuit protected by the circuit breaker (e.g. machine control) to be placed in safety configuration.

Technical data

Auxiliary trip units		iMN			iMNs	
Catalogue numbers		A9A26960	A9A26961	A9A26959	A9A26963	
Main characteristics						
Rated voltage ⁽¹⁾ (Un)		220...240 V, 50/60Hz	48 V, 50/60Hz	48 V DC	115 V, 400 Hz	220...240 V, 50/60Hz
Holding current ⁽²⁾ A		0.014	0.022	0.034	0.017	0.014
Power consumption VA		3.3	1.6	1.1	2	3.4
Tripping						
Threshold (V)		Between 0.35 and 0.75 of Un				
Duration of voltage dip (ms)		Min. 30	8	8	30	200
Restoration						
Threshold (V)		Min. 187	40.8	40.8	98	187
Additional characteristics						
Endurance		20,000 operations				
Insulation voltage (Ui)		400 V				
Degree of pollution		3				
Rated impulse withstand voltage (Uimp)		4 kV (6 kV relative to the associated protective device)				

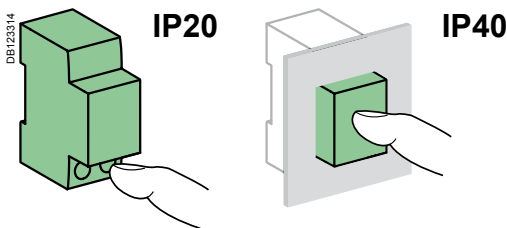

(1) For a lower power supply (e.g., control by a PLC output), an RTBT interface must be implemented (see page 7).
 (2) This characteristic must be taken into account to define the number of multiple controls by switches provided with an indicator lamp.

Operation timing chart

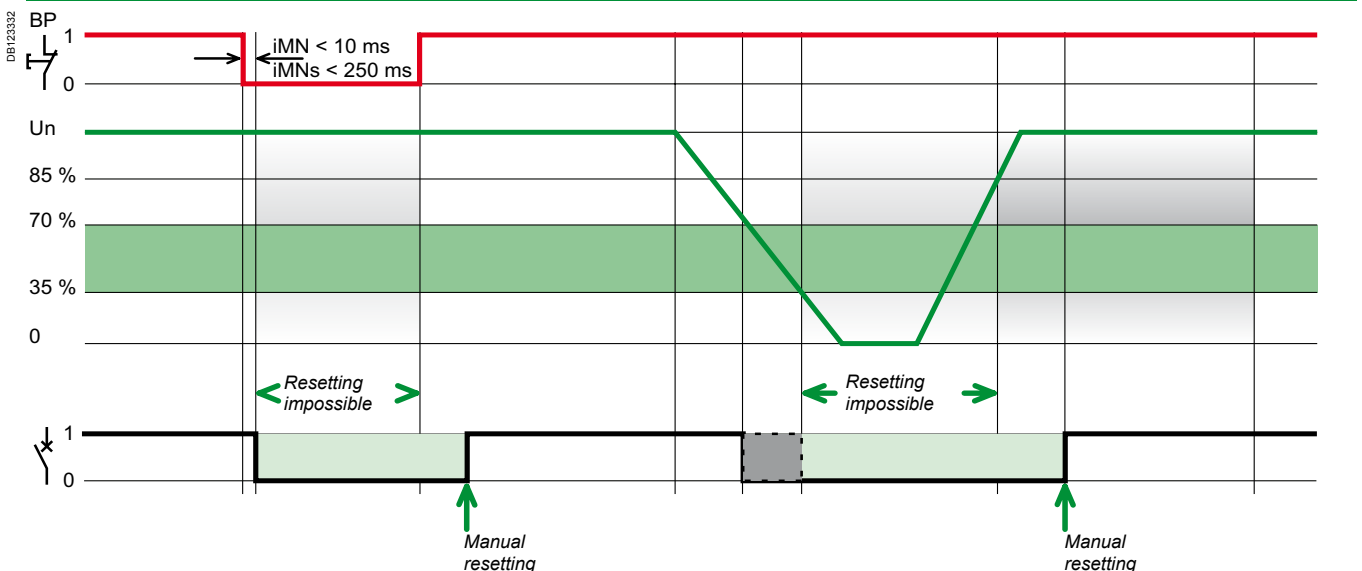

Auxiliary trip units for Acti9 protective devices (cont.)

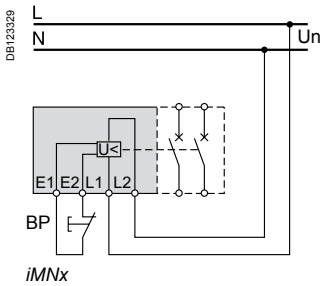

iMNx: trip units with push-button control

Function

- Tripping of the associated protective device by opening of the control circuit (e.g. push-button, dry contact).
- A drop in the supply voltage does not trip the associated protective device.
- A locking push-button control allows the circuit protected by the circuit breaker (e.g. machine control) to be placed in safety configuration.

Technical data

Auxiliary trip units		iMNx	
Catalogue numbers		A9A26969	A9A26971
Main characteristics			
Rated voltage ⁽¹⁾ (Un)		220...240 V, 50/60 Hz	380...415 V, 50/60 Hz
Power consumption (at Un)	A	0.014	
Tripping			
Threshold (V)		70 % of U _e	
Control-circuit opening duration (ms)	Min.	30	
Additional characteristics			
Endurance		20,000 operations	
Insulation voltage (U _i)		400 V	
Degree of pollution		3	
Rated impulse withstand voltage (U _{imp})		4 kV (6 kV relative to the associated protective device)	

(1) For a lower supply voltage (e.g., control by a PLC output), an RTBT interface must be implemented (see page 7).

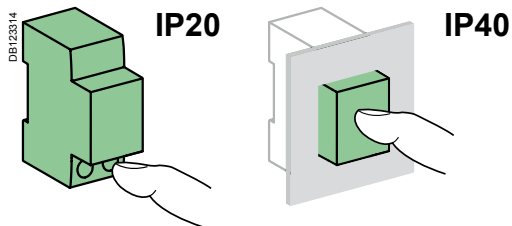

Operation timing chart

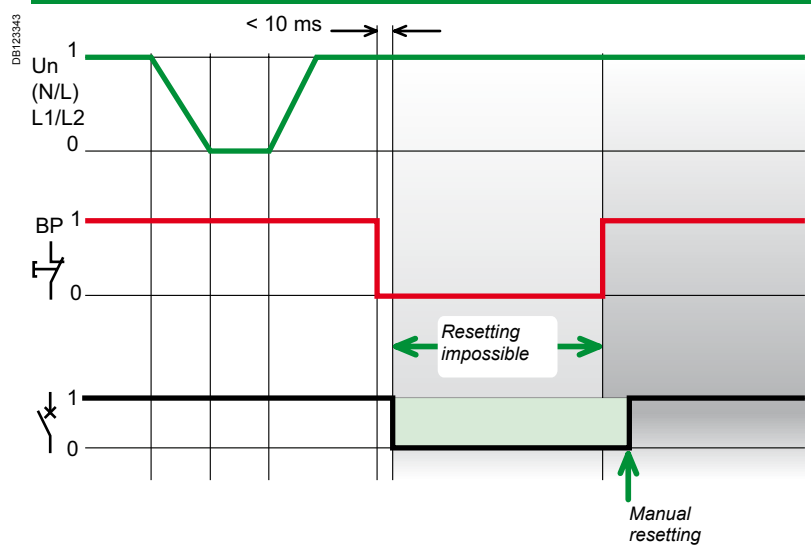

Auxiliary trip units for Acti9 protective devices (cont.)

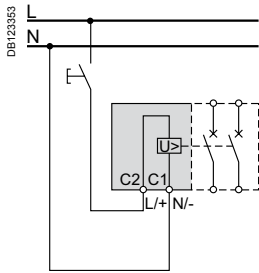

iMX powered by main network

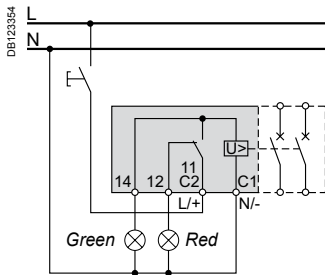

Control by N/O push-button with verification of voltage presence (iMX+OF)

iMX, iMX+OF: shunt release units

Function

- Tripping of the associated protective device when a voltage appears across the terminals of the auxiliary (control by: N/O push-button, dry contact, etc.).
- Resetting of the protective device is possible only when the voltage across the terminals of the auxiliary has disappeared.
- A locking push-button control allows the circuit protected by the circuit breaker (e.g. machine control) to be placed in safety configuration.

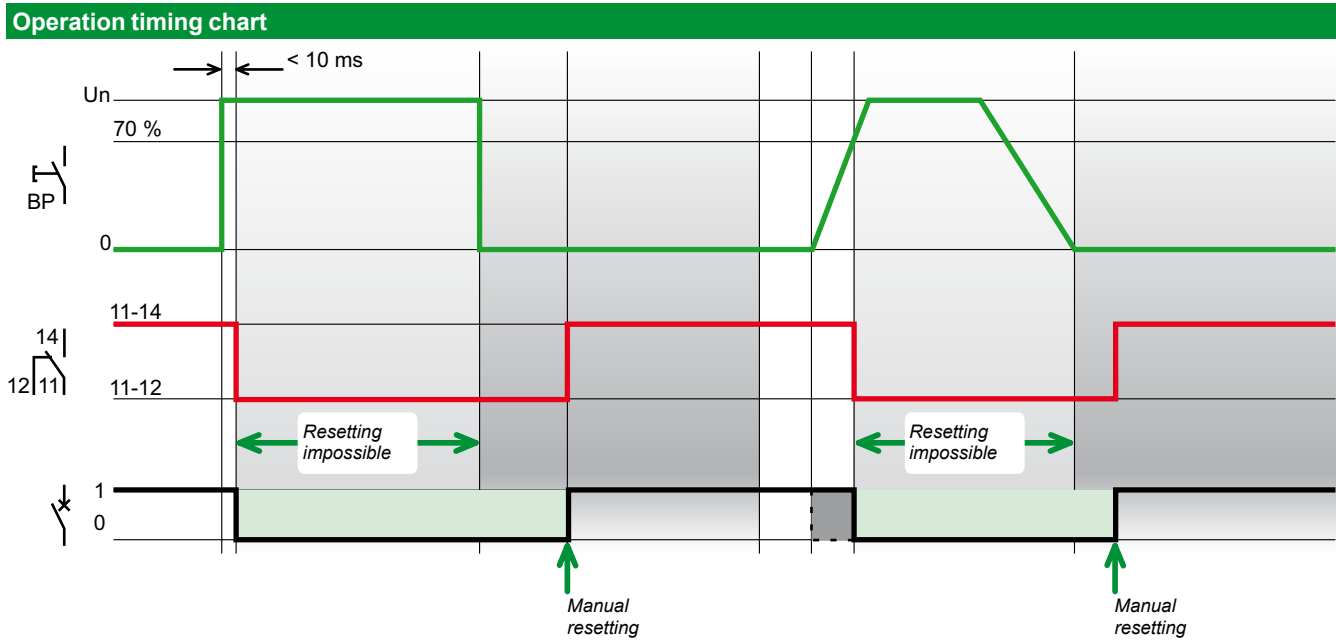

Auxiliary trip units for Acti9 protective devices (cont.)

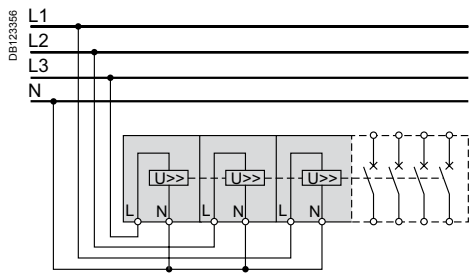

Three-phase power supply monitoring

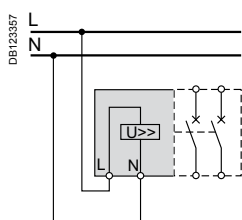

Single-phase power supply monitoring

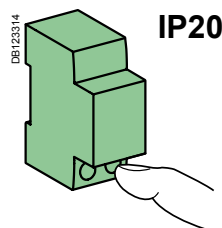

IP20

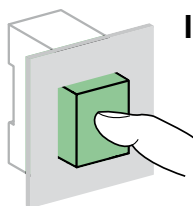

IP40

iMSU: overvoltage release units

Function

- Tripping of the associated protective device when the voltage across its terminals exceeds its nominal value.
- This auxiliary can protect sensitive loads from mains voltage fluctuations, in particular those due to breakage of the neutral conductor.
- Resetting of the protective device is possible only when the voltage across the terminals of the auxiliary has returned to its nominal value.

Technical data

Auxiliary trip units		iMSU	
Catalogue numbers		A9A26479	A9A26979
Main characteristics			
Rated voltage (Un)		230 V, 50/60 Hz	
Power consumption (at Un)		A	
Power consumption		Holding	VA
		Inrush	VÂ
Insulation voltage (Ui)		400 V	
Degree of pollution		3	
Rated impulse withstand voltage (Uimp)		4 kV (6 kV relative to the associated protective device)	
Additional characteristics			
Endurance		20,000 operations	

Tripping threshold and time

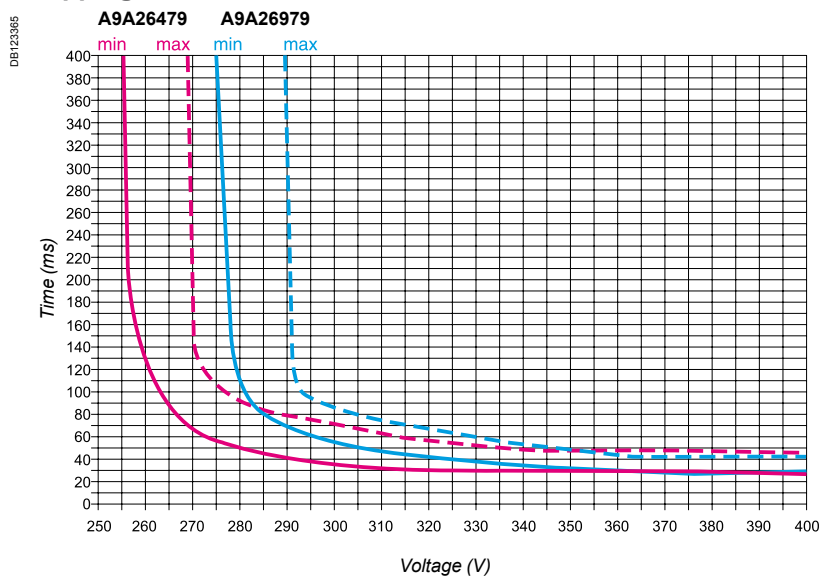

063960A_SE-40



"Low-level" control

The RTBT relay cat. no. 15416 allows the auxiliary trip units to be controlled by a low-level signal (e.g. iMN).

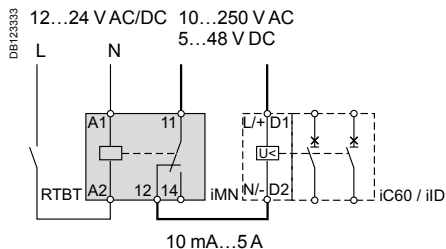

RTBT relay

Type	Voltage (Ue)	Current rating (Ie)
Inputs (A1, A2)	12...24 V AC/DC, 0...60 Hz	-
Outputs (11 and 12, 11 and 14)	10...250 V AC	10 mA...5 A
	5...48 V DC	

Electrical auxiliaries for iC60, iID, iSW-NA, ARA and RCA

The mounting order for the various auxiliaries must be complied with. The tripping auxiliaries (iMN, iMX) should be mounted first, as close as possible to the circuit breaker or the residual current circuit breaker. Then, the indicating auxiliaries (iOF, iSD) should be mounted, complying with their position shown in the following table.



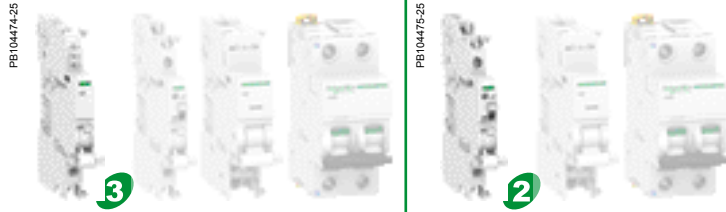









Indicating auxiliaries



1 iOF/SD+OF	1 iOF/SD+OF
1 iOF	1 (iSD or iOF or iOF/SD+OF)
No	No
1 iSD	1 iOF/SD+OF
1 iSD	1 iSD
1 iOF/SD+OF	1 iOF/SD+OF
1 iOF/SD+OF	1 iOF/SD+OF
1 iOF	1 (iSD or iOF or iOF/SD+OF)
No	No
No	1 (iSD or iOF or iOF/SD+OF)
1 iOF	1 (iSD or iOF or iOF/SD+OF)
No	1 (iSD or iOF or iOF/SD+OF)
1 iOF	1 (iSD or iOF or iOF/SD+OF)

**The tripping auxiliaries should be installed first.
Comply with the position of the SD function.**

Electrical auxiliaries for iC60, iID, iSW-NA, ARA and RCA (cont.)

	Tripping auxiliaries	Remote control	Device	Vigi iC60
		ARA automatic recloser or RCA remote control	iC60 circuit breaker or iID residual current circuit breaker or iSW-NA switch-disconnector	Vigi iC60 add-on residual current device
1 (iMX or iMN or iMSU) max.	-		 iC60	 Vigi iC60
2 (iMX or iMN or iMSU) max.				
3 iMSU max.				
1 (iMX or iMN or iMSU) max.				
2 (iMX or iMN or iMSU) max.				
1 (iMX or iMN or iMSU) max.	-		 iID/iSW-NA	
2 (iMX or iMN or iMSU) max.				
3 iMSU max.				
1 (iMX or iMN or iMSU) max.		 ARA	 iC60	 Vigi iC60
No				
1 (iMX or iMN or iMSU) max.		 RCA	 iID/iSW-NA	
No				
1 (iMX or iMN or iMSU) max.		 RCA	 iC60	 Vigi iC60
No				

Influence of ambient temperature

Influence of temperature on the operation of Acti9 devices

Devices	Characteristics influenced by temperature	Temperature	
		Min.	Max.
iK60 circuit breakers	Tripping on overload	-25°C	+60°C
iID K residual current circuit breakers		-5°C	+40°C
iC60a/N/H/L circuit breakers	Without Vigi	Tripping on overload	-35°C
	With Vigi (AC)		-5°C
	With Vigi (A, Asi)		-25°C
iID residual current circuit breakers	AC	Maximum operating current	-5°C
	A, Asi		-25°C
Protection auxiliaries	None	-35°C	+70°C
iCT contactors	Installation conditions	-5°C	+60°C
iTL impulse relays	None	-20°C	+50°C
iCT, iTL auxiliaries	None	-20°C	+50°C
Distribloc	Maximum operating current	-25°C	+60°C
Multiclip	Maximum operating current	-25°C	+60°C

Note: the temperature considered is the temperature viewed through the device.

iK60, iC60 circuit breakers

Températures élevées

- A rise in temperature causes lowering of the thermal threshold (tripping on overload).
- Protection is still ensured: the tripping threshold remains lower than the current acceptable by the cable (I_z)
- To prevent nuisance tripping, it should be checked that this threshold remains higher than the maximum operating current (I_B) of the circuit, defined by:
 - the rated load currents,
 - the coefficients of expansion and simultaneity of use.
- The curve below indicates the minimum value of the threshold, relative to the rated current I_n , as a function of the temperature in the vicinity of the circuit breaker.

Example for a three-phase circuit having the following characteristics:

- Cable (acceptable current I_z 68 A), protected by an iC60 circuit breaker of rating 63 A
 - Maximum current that can be demanded by the loads (I_B): 60 A.
- This current represents 0.95 times the rating of the circuit breaker: based on the curve opposite, there is no risk of nuisance tripping so long as the temperature does not exceed +65°C.

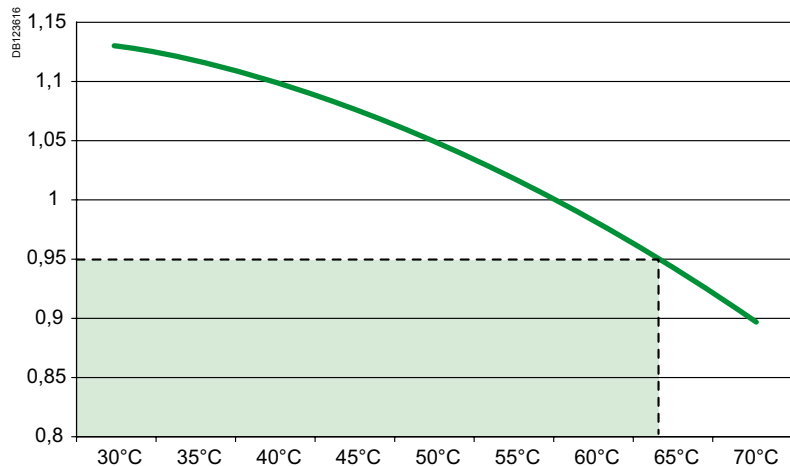

If the temperature is sufficiently high for the tripping threshold to become lower than the operating current I_B , switchboard ventilation should be provided for.

Influence of ambient temperature (cont.)

Low temperatures

- A fall in temperature increases the thermal tripping threshold of the circuit breaker.
- There is no risk of nuisance tripping: the threshold remains higher than the maximum operating current of the circuit (I_B) demanded by the loads.
- It should be checked that the cable remains suitably protected, i.e. that its acceptable current (I_2) is higher than the values shown in the following table (in amperes):

Circuit breaker rating (A)	Ambient temperature						
	-35°C	-25°C	-15°C	-5°C	+5°C	+15°C	+25°C
0.5 A	0.62	0.60	0.58	0.57	0.55	0.53	0.51
1 A	1.3	1.2	1.2	1.1	1.1	1.1	1.0
2 A	2.6	2.5	2.4	2.3	2.2	2.1	2.0
3 A	3.9	3.8	3.6	3.5	3.4	3.2	3.1
4 A	5.1	5.0	4.9	4.7	4.5	4.3	4.1
6 A	7.8	7.5	7.2	7.0	6.7	6.4	6.1
10 A	13	12	12	11	11	11	10
16 A	19	19	18	18	17	17	16
20 A	25	24	23	22	22	21	20
25 A	30	29	28	28	27	26	25
32 A	39	38	37	36	35	34	33
40 A	49	48	47	46	44	42	41
50 A	61	60	58	57	55	53	51
63 A	78	76	74	72	70	67	64

- When the ambient temperature could vary within a broad range, both these aspects must be taken into account:
 - the difference between the maximum operating current of the circuit (I_B) and the tripping threshold of the circuit breaker for the minimum ambient temperature,
 - the difference between the strength of the cable (I_2) and the maximum tripping threshold of the circuit breaker for the maximum ambient temperature.

iID residual current circuit breakers

- For iID residual current circuit breakers, an ambient temperature higher than 40°C slightly reduces the acceptable main current.
- Up to 60°C, in all cases, the iID residual current circuit breakers are satisfactorily protected against overloads by an iC60 circuit breaker of the same rating, operating under the same ambient temperature.

iCT contactors

In the case of contactor mounting in an enclosure for which the interior temperature is in a range between 50°C and 60°C, it is necessary to use a spacer, cat. no. A9A27062, between each contactor.

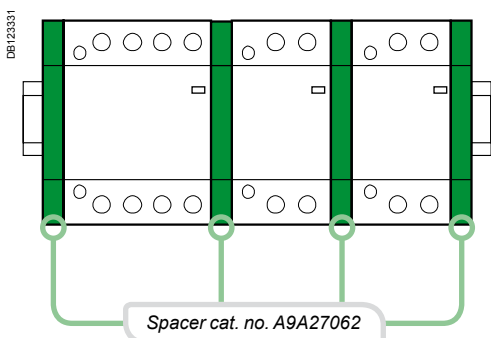

Splitter blocks

In the event of a temperature higher than 40°C, the maximum acceptable current is limited to the values in the table below:

Type	Temperature				
	40°C	45°C	50°C	55°C	60°C
Multiclip 80 A	80	76	73	69	66
Distribloc 63 A	63	60	58	55	53

Resistance to environmental conditions

Acti9 devices have successfully passed the environmental resistance tests specified in the building standards (IEC / EN 60898 and 60947-2 for circuit breakers, IEC / EN 61008 for residual current circuit breakers, etc.). Most of these tests were performed under the control of official bodies in different countries: the devices therefore carry the quality mark issued by each of these bodies.

Schneider Electric has also subjected these devices to additional tests with higher requirements, to give users reliability and sturdiness that are unparalleled on the market.

These tests checked that the Constraints described below did not have any significant effect on the main functions of the devices:

- Tripping (for protection devices).
- Isolation and dielectric withstand.
- Degree of protection (IP) of the casing.
- Grip on the mounting bracket (rail).
- Manual opening / closing.

Additional checks were performed for certain tests, mentioned in the tables below.

Constraints Type	Atmospheric				
	Humidity	Salt mist	Corrosive atmospheres		Dust
Standard defining the test protocol	IEC 60068-2-78	IEC 60068.2.52	IEC 60721-3-3		
Constraint level applied	Temperature 40°C, relative humidity 93%.	Severity 2 (maritime environment).	Classification 3C2: urban regions with industrial activities, heavy traffic.	Covered swimming pools atmospheres	Plaster deposits + bumps.
Additional checks after constraint		Conductivity, overheating. No corrosion.			Conductivity and overheating.
Circuit breakers					
iK60N	■	■	-	-	■
iC60a/N/H/L	■	■	■	■	■
Residual current circuit breakers					
iID K	■	■	-	-	■
iID	■	■	■	Asi only	■
Residual current devices					
iC60a/N/H/L + Vigi iC60	■	■	■	Asi only	■
Protection device auxiliaries					
iOF	■	■	■	-	■
iSD	■	■	■	-	■
iOF/SD+OF	■	■	■	-	■
iMN, iMNs	■	■	■	-	■
iMX, iMX+OF	■	■	■	-	■
iMNx	■	■	■	-	■
iMSU	■	■	■	-	■
Surge arresters					
iPF	-	-	-	-	-
iPRD	-	■	-	-	-
Mounting accessories					
Rotary handle	■	■	■	-	■
Plug-in base	■	■	■	-	■
Padlocking device	■	■	■	-	■
Safety accessories					
Screw shield	■	■	■	-	■
Interpole barrier	■	■	■	-	■
Spacer	■	■	■	-	■
Splitter blocks					
Multiclip	■	■	■	-	■
Distribloc	■	■	■	-	■
Comb busbars for iC60	■	■	■	-	■

Resistance to environmental conditions (cont.)

Mechanical						Storage
Vibrations, impacts and bumps	Vibrations	Bumps (repeated impacts)	Impacts	Impacts on the device	Falls	Damp heat
IEC 60721-3-3	IEC 60068.2-6	IEC 60068-2-27	IEC 60068-2-27	IEC 62262	IEC 60068-2-32	IEC 60068-2-30
Class 3M4: industrial environment with considerable vibrations and impacts (e.g. proximity of machines, circulation of vehicles).	Amplitude: 3.5 mm. Acceleration: 1 g. Directions: 3 axes. Frequency: 5 to 300 Hz.	Acceleration: 15 g. Pulse duration: 6 ms.	Force: 15 g. Pulse duration: 11 ms.	IK 07: 5 impacts of 0.7 J.	Height: 0.8 m, concrete floor.	Db: - Temperature: 55°C. - Relative humidity: 95%.
No power supply fault, no tripping.				Casing, degree of protection (IP).	Casing, degree of protection (IP).	
-	■	■	-	■	■	
■	■	■	■	■	■	
-	■	■	-	■	■	
■	■	■	■	■	■	
■	■	■	■	■	■	
■	■	■	■	■	■	■
■	■	■	■	■	■	■
■	■	■	■	■	■	■
■	■	■	■	■	■	■
■	■	■	■	■	■	■
-	-	-	-	-	■ Height: 0.6 m.	
-	■ Frequency: 8.5 to 100 Hz.	-	-	-		
■	■	■	■	■	■	
■	■	■	■	■	■	
■	■	■	■	■	■	
■	■	■	■	■	■	
■	■	■	■	■	■	
■	■	■	■	■	■	■
■	■	■	■	■	■	■
■	■	■	■	■	■	■

Temperature derating

Dissipated power and voltage drop for C120

Temperature derating IEC 60947-5 / GB 14048-2

The current used for the circuit breakers varies according to the ambient temperature where the circuit breaker is located.

If the circuit breaker is installed in an enclosure or in a hot place (boiler room, etc.), the current required to trip the circuit breaker in the event of an overload will be reduced. If the ambient temperature exceeds the reference temperature of the circuit breaker, the circuit breaker will then be "derated". That is why circuit breaker manufacturers provide tables indicating the derated current (A) to be applied for given temperatures.

From examples taken from these tables, it should be noted that if the ambient temperature is less than the rated temperature, the circuit breaker is "overrated". When several circuit breakers operating simultaneously are mounted side by side in a small enclosure, a temperature rise in the enclosure results in a reduction in the operating current.

In principle, this mutual temperature rise requires the application of an additional derating coefficient of 0.8.

The reference temperature is in a halftone colour.

Rating	Type	-25 °C	-20 °C	-15 °C	-10 °C	-5 °C	0 °C	5 °C	10 °C	15 °C	20 °C	25 °C	30 °C	35 °C	40 °C	45 °C	50 °C	55 °C	60 °C
		-13 °F	-4 °F	5 °F	14 °F	23 °F	32 °F	41 °F	50 °F	59 °F	68 °F	77 °F	86 °F	95 °F	104 °F	113 °F	122 °F	131 °F	140 °F
20 A	1P	24.60	24.18	23.75	23.32	22.87	22.42	21.96	21.48	21.00	20.51	20	19.48	18.95	18.40	17.83	17.24	16.64	16.01
	2P	24.83	24.39	23.94	23.48	23.02	22.54	22.06	21.56	21.05	20.53	20	19.45	18.89	18.30	17.70	17.08	16.44	15.76
	3P	24.45	24.04	23.63	23.21	22.77	22.34	21.89	21.43	20.97	20.49	20	19.50	18.99	18.46	17.91	17.35	16.77	16.17
30 A	1P	36.57	35.97	35.35	34.73	34.09	33.45	32.79	32.11	31.42	30.72	30	29.26	28.51	27.73	26.93	26.10	25.25	24.37
	2P	36.85	36.23	35.59	34.94	34.28	33.60	32.91	32.21	31.49	30.75	30	29.23	28.43	27.61	26.77	25.90	25.00	24.07
	3P	36.36	35.78	35.18	34.58	33.96	33.33	32.69	32.04	31.38	30.70	30	29.29	28.56	27.81	27.04	26.25	25.43	24.59
40 A	1P	48.77	47.96	47.14	46.31	45.46	44.60	43.72	42.82	41.90	40.96	40	39.02	38.00	36.97	35.90	34.80	33.66	32.48
	2P	50.50	49.55	48.58	47.59	46.58	45.55	44.50	43.42	42.31	41.17	40	38.79	37.55	36.26	34.93	33.54	32.09	30.58
	3P	50.05	49.14	48.21	47.26	46.29	45.30	44.29	43.26	42.20	41.12	40	38.85	37.67	36.45	35.19	33.87	32.51	31.09
50 A	1P	61.87	60.79	59.69	58.57	57.42	56.25	55.06	53.84	52.59	51.31	50	48.65	47.27	45.84	44.37	42.85	41.27	39.62
	2P	63.92	62.67	61.39	60.09	58.75	57.39	55.99	54.55	53.08	51.56	50	48.39	46.72	44.99	43.19	41.31	39.35	37.28
	3P	62.05	60.95	59.83	58.69	57.53	56.35	55.14	53.90	52.63	51.33	50	48.63	47.22	45.77	44.27	42.72	41.11	39.43
60 A	1P	75.66	74.25	72.80	71.33	69.82	68.28	66.71	65.10	63.44	61.75	60	58.20	56.35	54.43	52.44	50.37	48.22	45.96
	2P	75.47	74.07	72.64	71.18	69.69	68.17	66.62	65.03	63.40	61.72	60	58.23	56.40	54.51	52.55	50.52	48.40	46.19
	3P	74.41	73.10	71.76	70.40	69.01	67.59	66.14	64.66	63.15	61.59	60	58.36	56.68	54.94	53.15	51.30	49.37	47.37
80 A	1P	95.66	94.21	92.74	91.25	89.73	88.18	86.61	85.00	83.37	81.70	80	78.26	76.48	74.66	72.80	70.88	68.91	66.89
	2P	95.76	94.31	92.82	91.32	89.79	88.23	86.65	85.04	83.39	81.71	80	78.25	76.46	74.62	72.74	70.81	68.83	66.79
	3P	95.02	93.63	92.21	90.78	89.32	87.83	86.32	84.79	83.22	81.63	80	78.34	76.64	74.91	73.13	71.31	69.44	67.52

Dissipated power and voltage drop IEC 60947-5 / GB 14048-2

What is the dissipated power per pole?

The following table shows the dissipated power of the device in Watts for each rating, per pole, at In:

Rating (A)	20	30	40	50	60	80
C120 (W/pole)	2.8	3.4	3.5	3.6	4	4.5

What is the voltage drop per pole?

The following table shows the voltage drop of the device in mV for each rating, per pole, at In:

Rating (A)	20	30	40	50	60	80
C120 (mV/pole)	140	107	88	72	65	57

Short-circuit current limitation for C120

Thermal stress curve C

Ue: 240 V ~ 1P
Ue: 415 V ~ 2, 3P

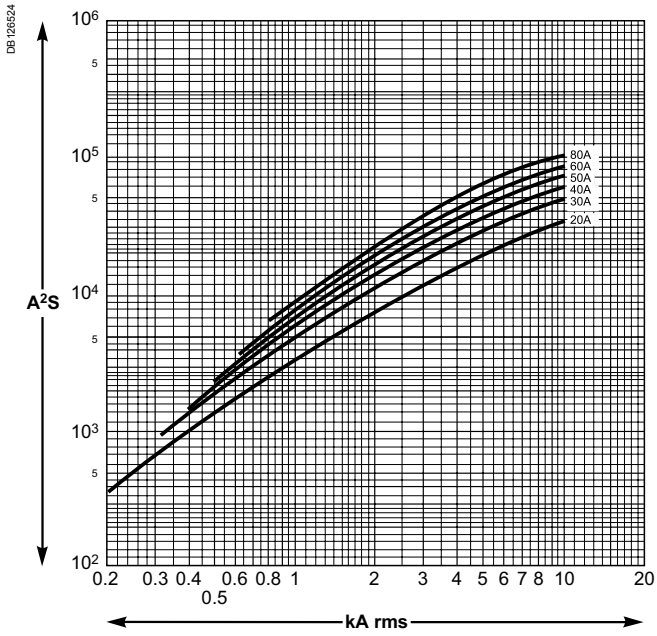

Ue: 240 V ~ 2, 3P

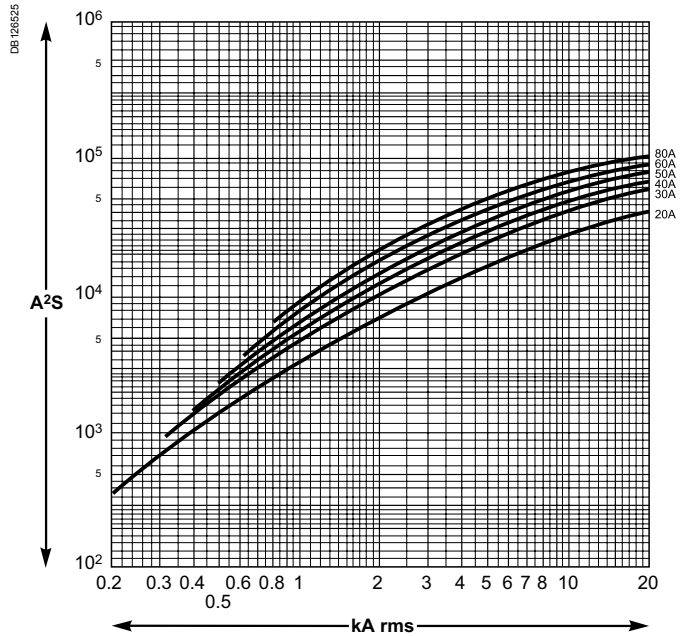

Ue: 440 V ~ 2, 3P

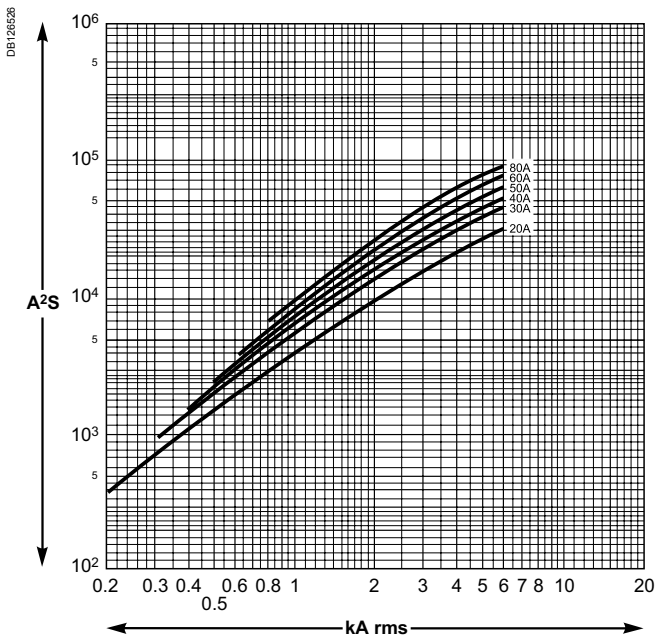

Short-circuit current limitation for C120

Peak current - 1P: 20 A - 2P: 30-40 A - 3 P: 50-60 A - 4P: 80 A

Ue: 240 V ~ 1P
Ue: 415 V ~ 2, 3P

Ue: 240 V ~ 2, 3P

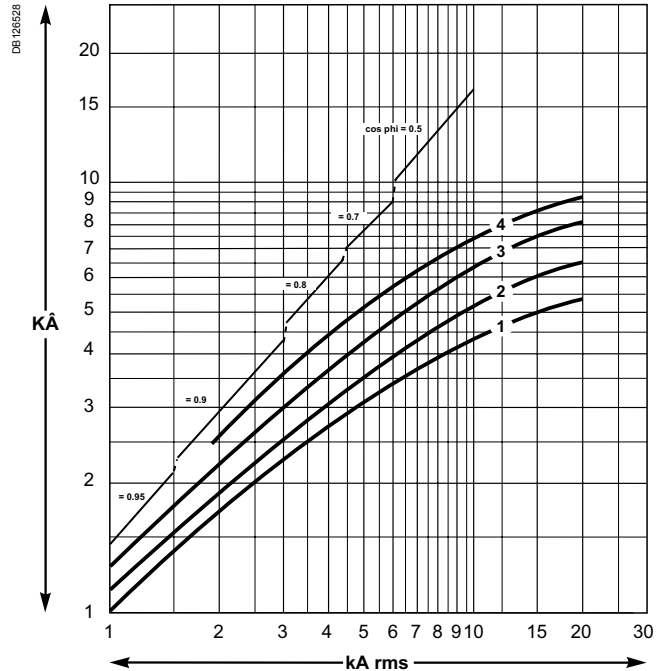
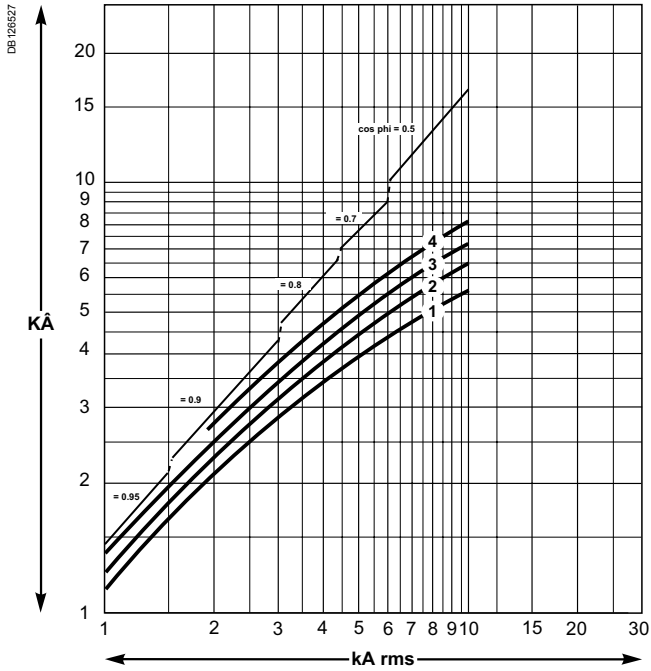

Ue: 440 V ~ 2, 3P

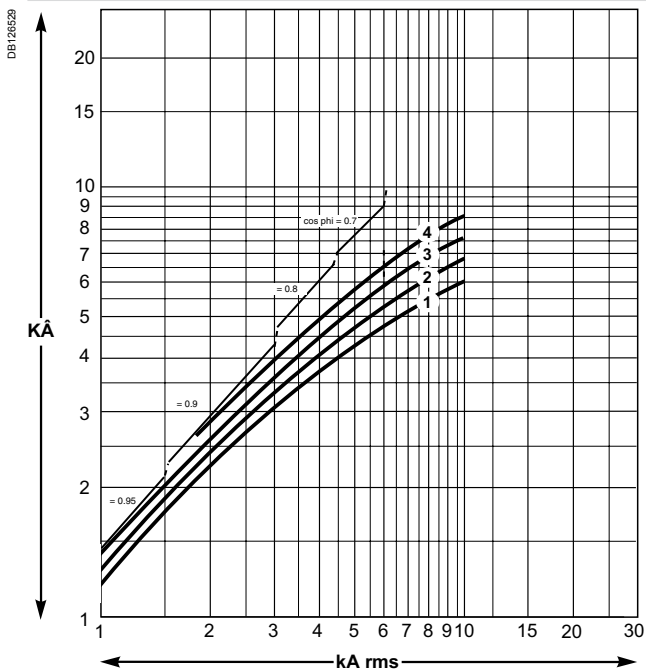

Tripping curves IEC 60947-5 / GB 14048-2

The operating range of the magnetic trip unit is included for:

- curve B: between 3.2 I_n and 4.8 I_n
- curve C: between 7 I_n and 10 I_n
- curve D: between 10 I_n and 14 I_n.

The curves show:

- the cold thermal tripping limits (25 °C), charged poles
- the electromagnetic tripping limits, 2 charged poles

C120

Curve B

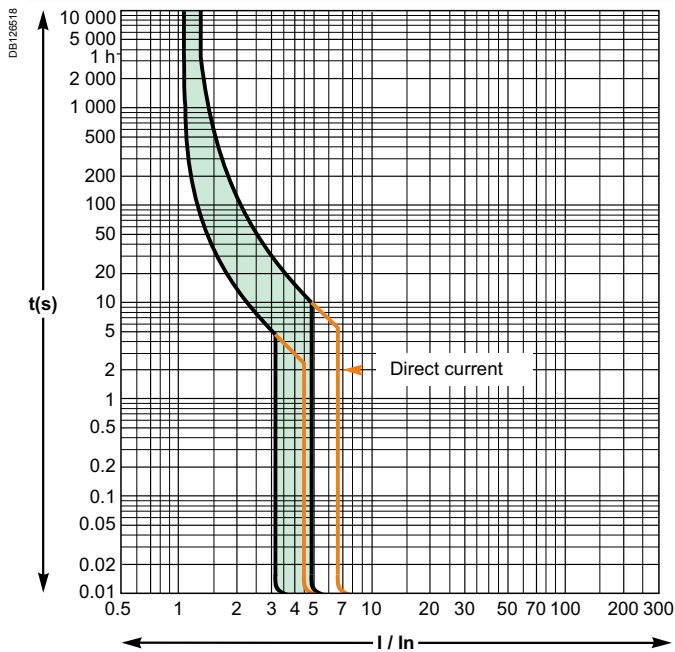

Curve C

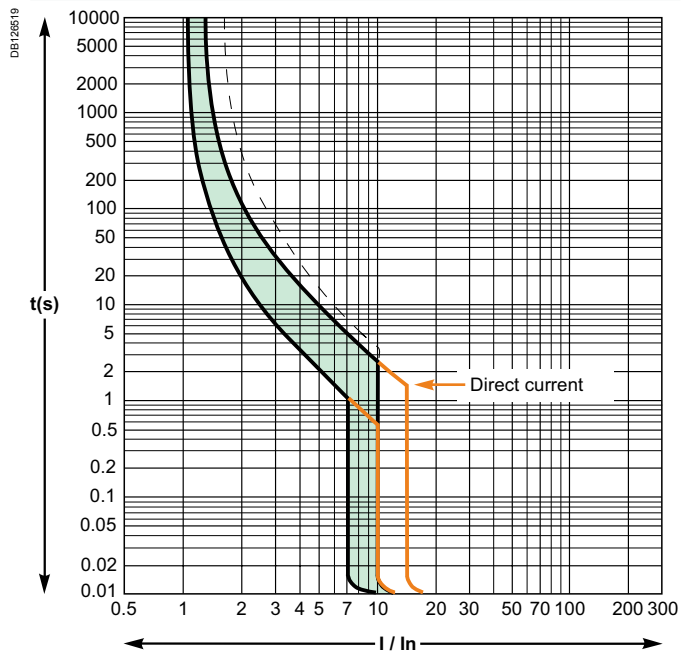

Curve D

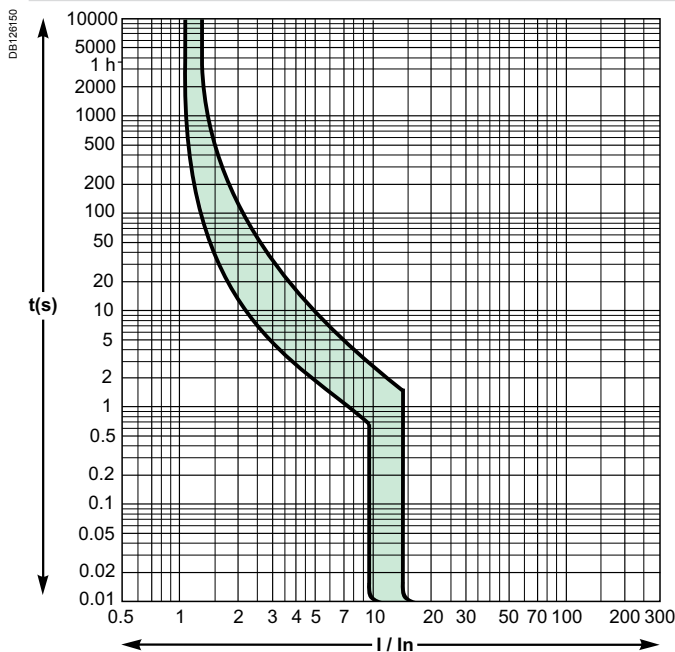

Use of contactors from 16 to 100 A

For automation needs in the housing, tertiary and industrial sectors, the range of modular CT contactors is used for:

- Power control of final circuits for housing and the tertiary sector:
 - lighting (luminous signs, shop windows, safety lighting, etc.)
 - heating, heat pumps, ovens
 - hot water for domestic use
 - small utility motors (pumps, fans, barriers, garage doors, etc.)
 - emergency stops and safety systems
 - air conditioning
- Energy distribution control:
 - load shedding and restoration
 - source changeover, etc.

Characterisation on load types

■ Standard IEC 61095 applies to electromechanical contactors for domestic and similar purposes. It differs from standard IEC 60947.4 (designed for industrial applications) by specific requirements relating to safety of persons and equipment in premises and corridors accessible to the general public.

Applications	Industrial: IEC 60947.4	Domestic: IEC 61095
Motor	AC3	AC7b
Heating	AC1	AC7a
Lighting	AC5a and b	AC5a and b

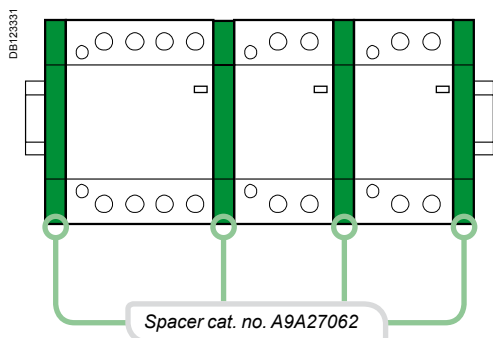

Use for temperatures between 50°C and 60°C

When contactors are mounted in enclosures with an internal temperature of between 50°C and 60°C, a spacer, catalogue number A9A27062, must be placed between each contactor.