



mountz[®]
the torque tool specialists[®]

Feb 2016

Operation Manual

Hybrid Digital Screwdriver

HDC-40i, HDC-35i



HD-Series

Hybrid Torque Control System

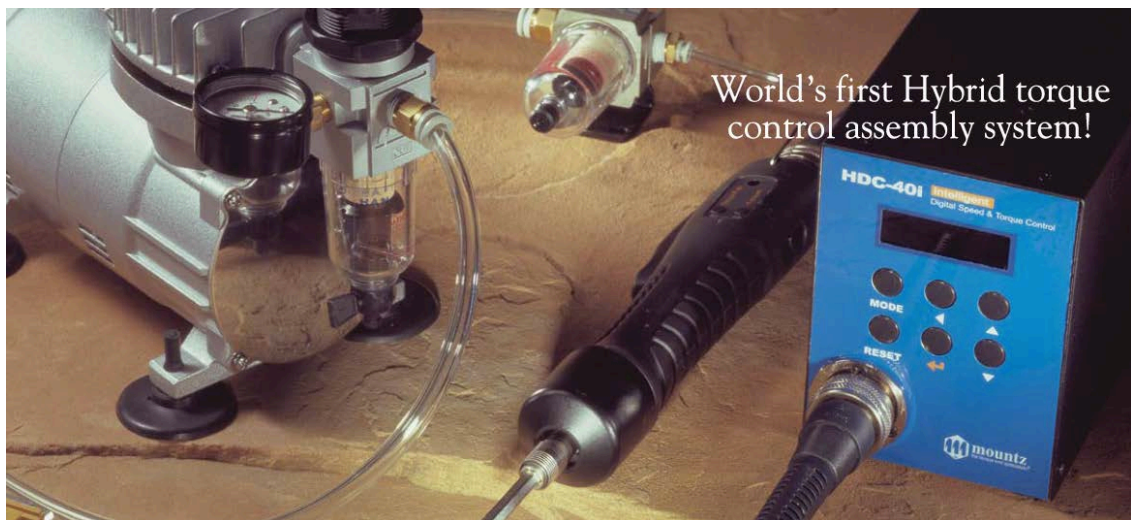

Hybrid Digital Screwdriver

HDC-40i, HDC-35i

Quick Set Up

Installation:

1. After unpacking system, please connect cable to driver and controller. Be aware that cable's ends are indetified so one specific end goes to controller and other to driver. Cable must snap in completely, please verify both ends are fully connected.

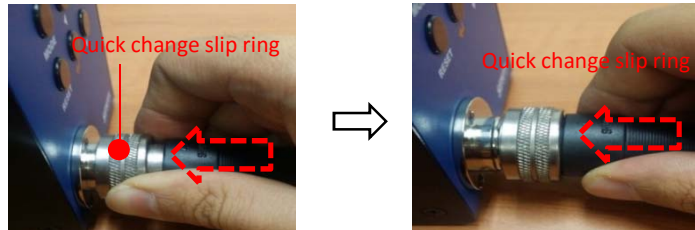

2. Connect Mini Compressor's air hose to the back of controller. Pull hose out to make sure it is correctly installed.

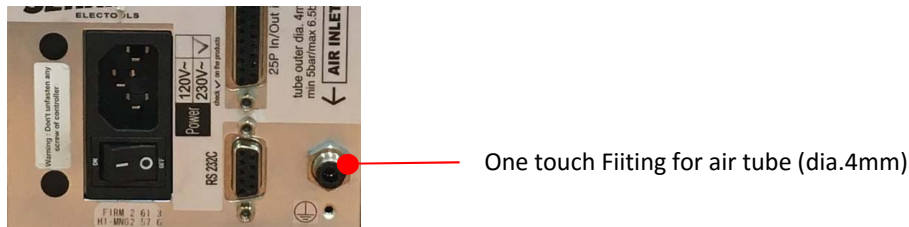

3. Connect power cord to the back of controllers and plug it into the 110V outlet. Turn on unit.
4. On Controller Keyboard, click on "mode" than click enter, than click "mode" again and than click enter. Display will show "P 1".
5. Type in P83 and click enter. A blinking "0" will b shown. Type in 77 and click enter. This will re-initialize the system. Please turn system OFF, wait 5 seconds and turn it ON.
6. With the use of the arrows, select P169 and click enter. A number will show up. PLEASE WRITE THIS NUMBER DOWN AS THIS IS THE FIRMWARE VERSION OF YOUR SYSTEM. Click reset button and than "mode" twice.
7. Please type in P59 and click enter. The display might show "0" or "1". Make sure "0" for USB communication is selected. If display showed "0" than click "reset" button. If "1" was shown, please change it to "0" than click enter.

Hi Manager Software:

1. Obtain firmware version of your system by Typing in 169 on the display of your controller.
2. Go to page 89 on this operation manual. Look at the chart and locate the corresponding Hi Manager Software for the Firmware you have writen down for your system.
3. Ask your Sales Rep for a copy of the Hi Manager Software you need according to Firmware Version of your System.

You can also request Hi Manager software on these email addresses below. (MAKE SURE YOU INDICATE FIRMWARE VERSION OF YOUR SYSTEM OBTAINED ON P169 when sending a request). john.brackmann@mountztorque.com, sergio.muratalla@mountztorque.com, damian.valdiviezo@mountztorque.com

Index

■ General & Specific safety rules	6
1. Products introduction	9
2. Key features	9
3. Specification	
3.1 Driver	10
3.2 Manual screwdriver models	11
3.3 Automation screwdriver models	12
3.4 Controller (HDC) specification	13
4. LAY-OUT	
4.1 Screwdriver LAY-OUT	14
4.2 HDC Controller LAY-OUT	15
4.3 HDC Controller Dimensions	16
5. Operation	
5.1 Front panel of controller	18
1) FND Display	18
2) Key Buttons	19
5.2 Parameter number group	20
5.3 Preset # & parameters	21
5.4 Torque, speed & angle setting (I) - by PC program	22
5.5 Torque, speed & angle setting (II) - on the front panel	23
5.6 Details of each parameter numbers	24
5.7 Error code	45
5.8 Preset # selecting by sensor	48
5.9 Wiring example of check out signal output	49
5.10 Preset # selecting in 25P I/O port	50

5.11 25P I/O port configuration	50
5.11.1 25P I/O configuration (I) - for Sensor	51
5.11.2 25P I/O configuration (II) - for PLC	52
5.11.3 25P I/O configuration (III) - for Sensor + PLC	53
5.11.4 25P Interface schematic - INPUT	54
5.11.5 25P Interface schematic - OUTPUT	55
5.11.6 Wiring of the Alarm signal to the Tower Lamp	56
5.11.7 Error code pin composition on 25P Output	56
5.12 25PIN I/O Timing Chart	57
5.13 Built in Screw Counter(patent)	58
5.13.1 Fastening quality verification	58
1) Fastening OK	58
2) Fastening NG	59
5.13.2 Count Start & Stop to HDC	60
5.13.3 Wiring of Count Start & Stop	64
5.13.4 Operation of screw counter on HDC	66
5.13.5 Operation of Model selecting	67
5.13.6 FND Display for Counter mode	68
5.13.7 FND Display for Model selecting	68
6. USB Communication	
6.1 Port and cable	69
6.2 USB driver install	69
7. RS-232C Communication	69
7.1 Connection	70
7.2 Protocol	71
7.2.1 Protocol Frame	71
7.2.2 Communication control letters	71

7.2.3 Command	71
7.2.4 Check sum	72
7.2.5 Details of Command	72
8. Auto fastening data output through USB port	76
9. PC communication software, <i>Hi-Manager</i>	77
9.1 Software install	77
9.2 How to use	77
9.3 Parameter setting on <i>Hi-Manager</i>	79
1) Fastening Setting	79
2) Controller Setting	80
3) Screw Count Setting	80
4) Multi Sequence	82
5) Driver setting	83
6) Model selecting	84
9.4 Monitoring on <i>Hi-Manager</i>	85
1) Screw Count monitoring	
2) Real time data monitoring	
10. Trouble shooting	87
11. <i>Hi-Manager</i> Software & Firmware Version History	89

1. GENERAL SAFETY RULES

WARNING! Read and understand all instructions. Failure to follow all instructions listed below, may result in electric shock, fire and/or serious personal injury

SAVE THIS INSTRUCTIONS

1.1 Work Area

- **Keep your work area clean and well lit.** Cluttered benches and dark areas invite accidents.
- **Do not operate power tools in explosive atmospheres, such as in the presence of flammable liquids, gases, or dust.** Power tools create sparks which may ignite the dust or fumes.
- **Keep bystanders, children, and visitors away while operating a power tool.** Distractions can cause you to lose control.

1.2 Electrical Safety

- **Grounded tools must be plugged into an outlet properly installed and grounded in accordance with all codes and ordinances. Never remove the grounding prong or modify the plug in any way. Do not use any plugs. Check with a qualified electrician if you are in doubt as to whether the outlet is properly grounded.** If the tools should electrically malfunction or break down, grounding provides a low resistance path to carry electricity away from the user.
- **Avoid body contact with grounded surface ad pipes, radiators, ranges and refrigerators.** There is an increased risk of electric shock if your body is grounded.
- **Don't expose power tools to rain or wet conditions.** Water entering a power tool will increase the risk of electric shock
- **Do not abuse the cord. Never use the cord to carry the tools or pull the plug from an outlet. Keep cord away from heat, oil, sharp edges or moving parts. Replace damaged cords immediately.** Damaged cords increase the risk of electric shock.
- **When operating a power tool outside, use an outdoor extension cord marked W-A or W.** These cords are rated for outdoor use and reduce the risk of electric shock.

1.3 Personal Safety

- **Stay alert, watch what you are doing and use common sense when operating a power tool. Do not use tool while tired or under the influence of drugs, alcohol, or medication.** A moment of inattention while operating power tools may result in serious

personal injury.

- **Dress properly. Do not wear loose clothing or jewelry. Contain long hair. Keep your hair, clothing, and gloves away from moving parts.** Loose clothes, jewelry, or long hair can be caught in moving parts.
- **Avoid accidental starting. Be sure switch is off before plugging in.** Carrying tools with your finger on the switch or plugging in tools may result in personal injury.
- **Remove adjusting keys or switches before turning the tool on.** A wrench or a key that is left attached to a rotating part of the tool may result in personal injury.
- **Do not overreach. Keep proper footing and balance at all times.** Proper footing and balance enables better control of the tool in unexpected situations.
- **Use safety equipment. Always wear eye protection.** Dust mask, non-skid safety shoes, hard hat, or hearing protection must be used for appropriate conditions.

1.4 Tool use and Care

- **Use clamps or other practical way to secure and support the workplace to a stable platform.** Holding the work by hand or against your body is unstable and may lead to loss of control.
- **Do not force tool. Use the correct tool for your application.** The correct tool will do the job better and safer at the rate for which it is designed.
- **Do not use tool if switch does not turn it on or off.** Any tool that cannot be controlled with the switch is dangerous and must be repaired.
- **Disconnect the plug from the power source before making any adjustments, changing accessories, or storing the tool.** Such preventive safety
- **Store idle tools out of reach of children and other untrained persons.** Tools are dangerous in the hands of untrained users.
- **Maintain tools with care. Keep cutting tools sharp and clean.** Properly maintained tools, with sharp cutting edges are less likely to bind and are easier to control.
- **Check for misalignment or binding of moving parts, breakage of parts, and any other condition that may affect the tools operation. If damaged, have the tool serviced before using.** Many accidents are caused by poorly maintained tools.
- **Use only accessories that are recommended by the manufacturer for your model.** Accessories that may be suitable for one tool, may become hazardous when used on another tool.

1.5 SERVICE

- **Tool service must be performed only by qualified personnel.** Service or maintenance performed by unqualified personnel could result in a risk of injury
- **When servicing a tool, use only identical replacement parts. Follow instructions in the Maintenance section of this manual.** Use of unauthorized parts or failure to follow Maintenance instructions may create a risk of electric shock or injury.

2. SPECIFIC SAFETY RULES

2.1 Hold tool by insulated gripping surfaces when performing an operation where the cutting tool may contact hidden wiring or its own cord. Contact with a "live" wire will make exposed metal parts of the tool "live" and shock the operator.

2.2 Never lubricate aerosol oil on to the electrical part.

1. Product Introduction

A driver system consists of screwdriver with built-in BLDC motor, controller which provide and control the DC power and pressed air to the screwdriver. They are connected together with the special cable.

1) Standard Item



2) Optional accessories



2. Key features

- 1) Digital torque set and save 8 memories
- 2) Long endurance, less noise and heat, and light weight screwdriver
- 3) Selectable high speed up to 1,800 rpm
- 4) High efficient BLDC motor made by Maxon, Swiss
- 5) Economic cost against the compatible digital torque control screwdriver
- 6) Monitoring fastening quality and count of screw numbers
- 7) Error information by code display
- 8) Programing and monitoring PC software
- 9) Maintenance information and history memory

3. Screwdriver

3.1 Specifications

no	Item	Specification		Remark
1	El. Power	DC40V, 3A max (HDC-40i)	DC35V, 4A max (HDC-35i)	
2	Motor	Maxon BLDC motor		
3	Dimension	refer 3.2 screwdriver model		
4	Torque range	refer 3.2 screwdriver model		0.1 Kgf.cm/scale
5	Speed range	refer 3.2 screwdriver model +/- 5%		10 rpm/scale
6	Torque accuracy	+/- 10% full scale		
7	Torque repeatability	+/- 5%		
8	Bit size	A:1/4" Hex, B:5mm Hex		
9	Start	Lever or Push start (selectable)		
10	Cable	14 wire+air tube all in one / 3M		

** Bit Socket size: A = 1/4" hexagonal, B = 5mm hexagonal
 example) HD150P-A : with Push to start - 1/4" hex bit socket

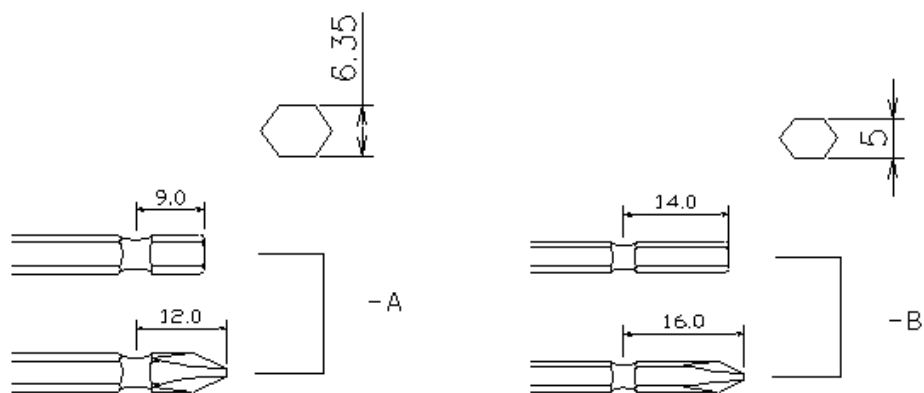

3.2 Manual screwdriver models

Model	Torque (Lbf.in)	Speed (rpm)	Weight (Kg)	Start	Power	Controller
HD081	2.6 - 6.9	500-1,700	0.44	Lever	40V	HDC-40i
HD150	4.7 - 13.4	500-1,700	0.44	Lever		
HD150P	4.7 - 13.4	500-1,700	0.44	Push		
HD220	6.0 - 19.0	400-1,250	0.44	Lever		
HD220P	6.0 - 19.0	400-1,250	0.44	Push		
HD350	8.6 - 30.3	300-740	0.51	Lever		
HD350P	8.6 - 30.3	300-740	0.51	Push		
HD450	8.6 - 39.0	300-600	0.51	Lever		
HD450P	8.6 - 39.0	300-600	0.51	Push		
HD35N	10.4 - 30.3	500-1,500	0.7	Lever	35V	HDC-35i
HD35NP	10.4 - 30.3	500-1,500	0.7	Push		
PHD35N	10.4 - 30.3	500-1,500	0.82	Pistol		
HD50N	13.0 - 43.4	300-1,050	0.7	Lever		
HD50NP	13.0 - 43.4	300-1,050	0.7	Push		
PHD50N	13.0 - 43.4	300-1,050	0.82	Pistol		
HD100N	26.0 - 86.6	250~500	0.75	Lever		
PHD100N	26.0 - 86.6	250~500	0.86	Pistol		

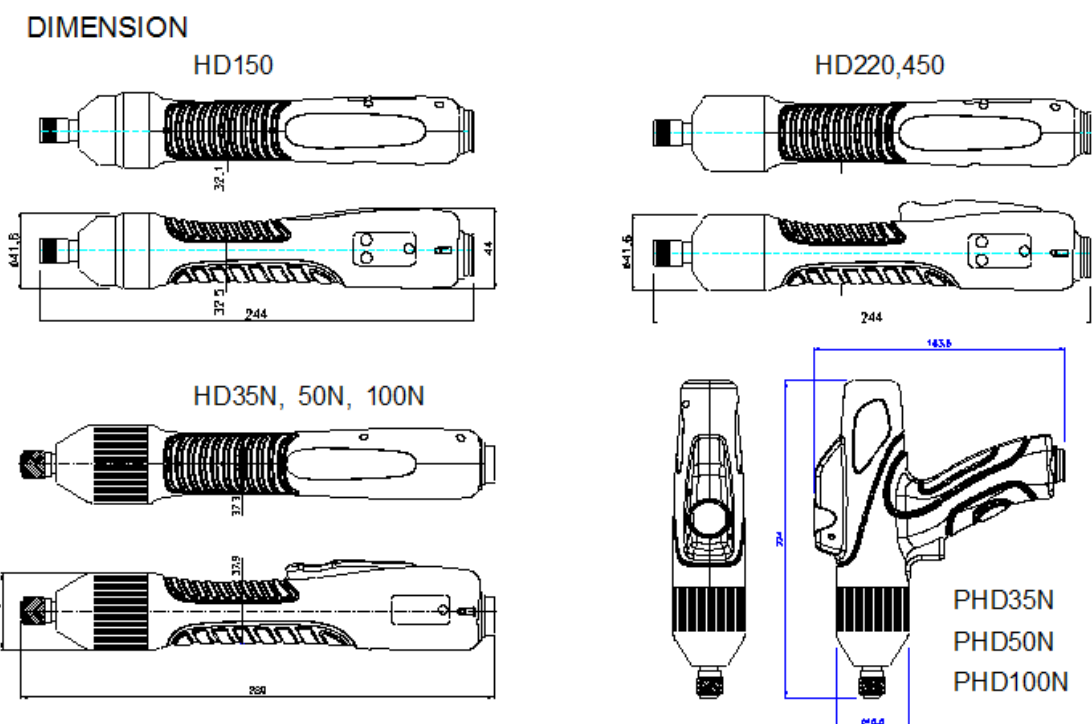

3.3 Automation screwdriver models

Model	Torque (Lbf.in)	Speed (rpm)	Power	Controller
HDA150	4.7 - 13.4	500-1,700	40V	HDC-40i
HDA220	6.0 - 19.0	400-1,250		
HDA350	8.6 - 30.3	300-740		
HDA450	8.6 - 39.0	300-600		

** Add suffix "V" after model name for vacuum pick-up assy option

DIMENSION

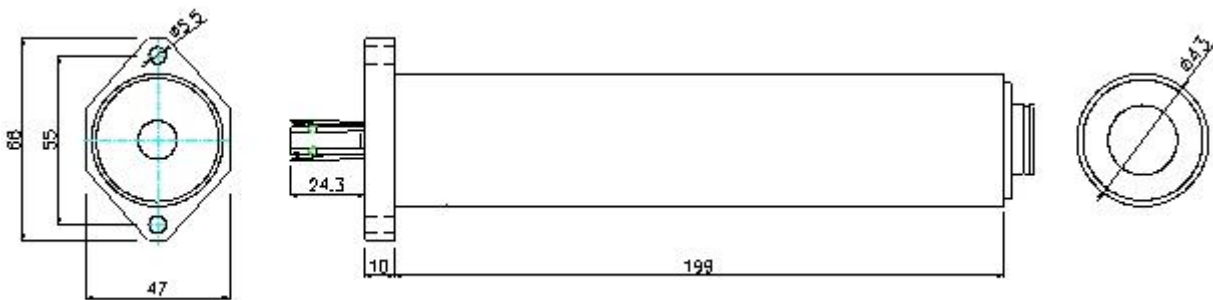

HDA150, HDA220, HDA350, HDA450

3.4 Controller (HDC) specification

no	Item	Specification		
1	Model	HDC-40i	HDC-35i	
2	Input (Electric)	AC110VC or AC220V, 50~60Hz		
3	Input (air pressure)	Min 4.5 bar / Max 6 bar		
4	Output (Electric)	DC40V, 3A	DC35V, 4A	
5	Fuse	AC250V 10A	AC250V 15A	
6	Dimension / Weight	refer the drawing		
8	Control	Torque	5-45 Kgf.cm	12-100 Kgf.cm
		Speed	300 - 1,700 rpm	300 - 1,500 rpm
		Angle	0.1 - 10 turns	
9	Preset parameters	Torque, Speed & Angle in 8 preset numbers		
10	Selecting the preset no.	1) Front panel button 2) 25P I/O interface 3) 8 direct sensor connecting port 4) F1 button on the driver		
11	Torque Adjust	- 20% ~ +20%		
12	Auto detection of the connected driver	Auto detection of the offset value from the EEP-rom on the driver		
13	Error display	Error display by code no. in system, communication & pattern error group		
14	Fastening quality control	OK/NG monitoring of screw fastening by preset pattern of angles, times		
15	Screw Counter	Save the total screw number, and monitoring the number of OK fastening screws.		
16	Monitoring and parameter	Monitoring and parameter setting on the PC program (MS Windows base)		

4. LAY-OUT

4.1 Screwdriver LAY-OUT

(1) Screwdriver for HDC-40i



(2) Screwdriver for HDC-35i



4. LAY-OUT

4.2 HDC Controller LAY-OUT

[Front]



[Back]

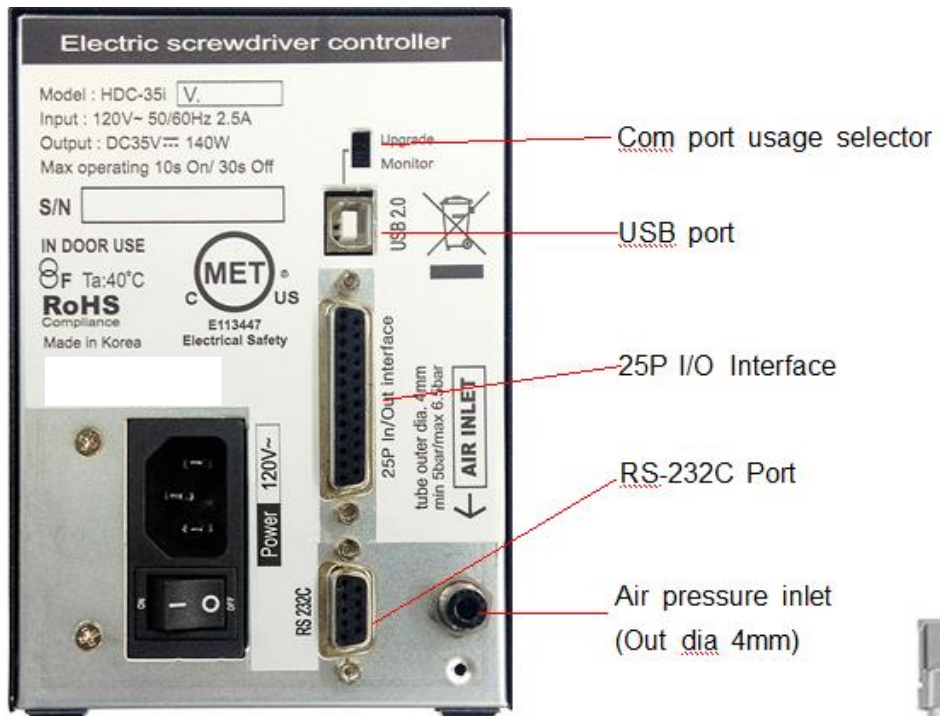

Air Filter (Option) - Recommended to be located before the air pressure inlet.



4.3 HDC controller Dimensions

[HDC-40i Controller]

unit : mm

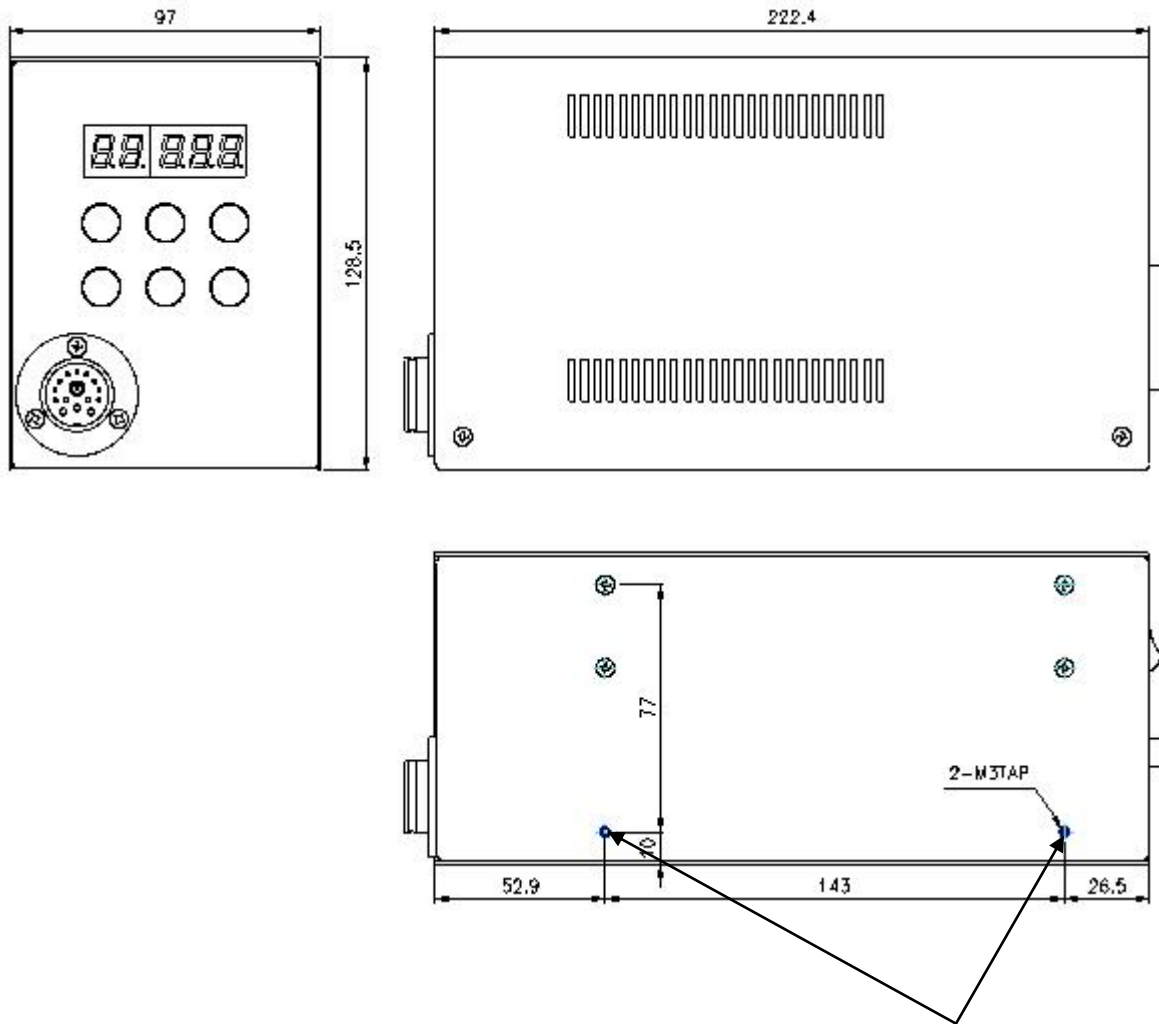

These two screws can be removed for mounting

Two M3 thread holes for mounting controller

Two screws at the side can be removed for extra mounting holes.

[Caution] Screw should not go through over 5mm inside

Dimension / Weight	97(w) 222(d) 129(h)mm / 2.1Kg
--------------------	-------------------------------

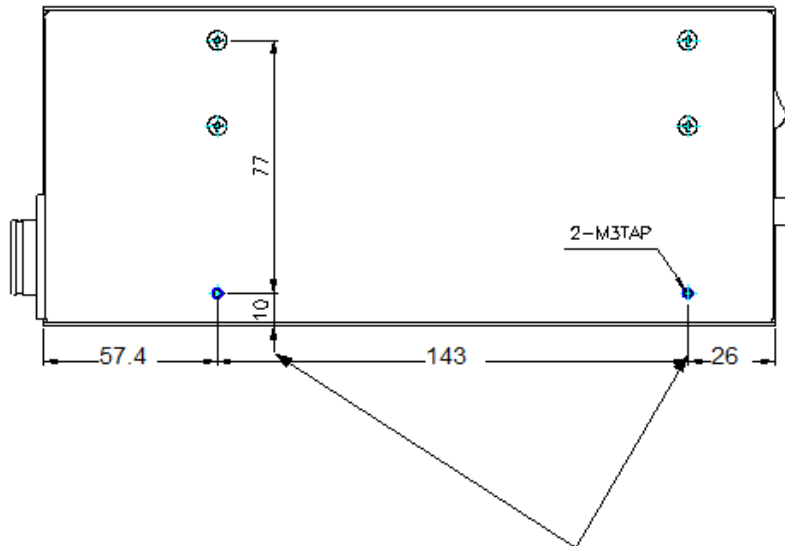
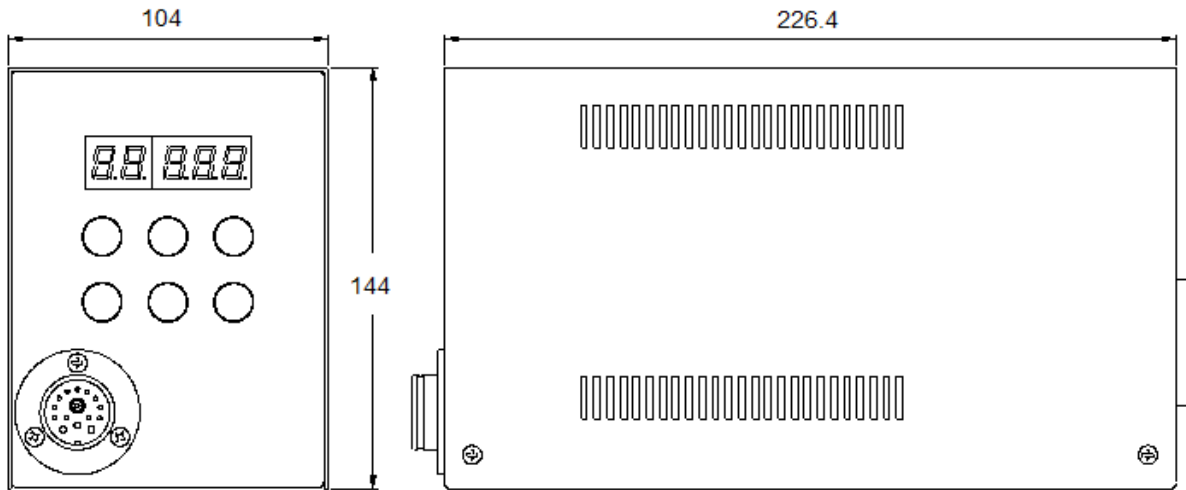

These two screws can be removed for mounting

Two M3 thread holes for mounting controller
 Two screws at the side can be removed for extra mounting holes.

[Caution] Screw should not go through over 5mm inside

Dimension / Weight	104(w) 226.4(d) 144(h)mm / 2.6Kg
--------------------	----------------------------------

5. Operation

5.1 Front panel of controller



1) FND Display (5 digit)

■ Torque or Speed display selected

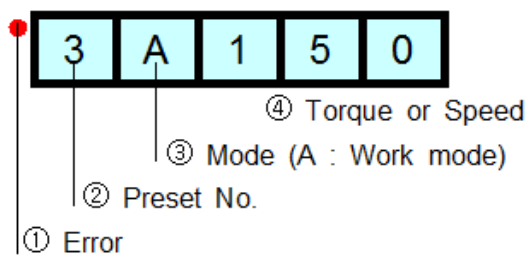

■ Screw Count display selected

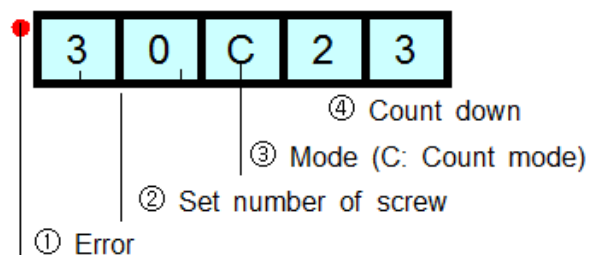

■ Model selecting

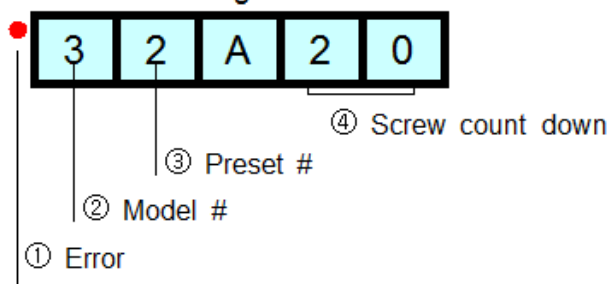

2) Key Buttons

MODE button :

By pressing the MODE button, it circulate **Auto**, **Log-in and Parameter** mode. Auto means operating. Before parameter mode, password required. Every settings is possible in Parameter mode.

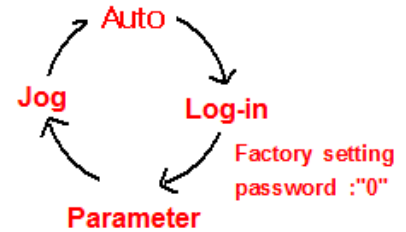

button

Log-in Mode	Log-in is required for parameter setting with password Initial password "0" can be changed on P89
Parameter Mode	Cursor shift up to left at the Parameter mode

button

Auto(Work) Mode	Select the next preset number or Model no. when P75 model select is enabled.
Log-in & Password	It increase the number up

button

	time	FND Display	Description
Auto (Operation) Mode	Initial	0A000	Initial display at the Auto(Work) mode
	1st	t	Display the temperature of driver inside (unit : 0.1 °C)
	2nd	F	The latest Fastening time (unit: mS)
	3rd	L	The latest Loosening time (unit: mS)
	4th	Pc	The latest current value (unit : 0.1A)
	5th	tu	The latest Fastening turns (unit: 0.1 turn)
	6th	SF Lo	Status of Start & Torque up sensor (F:off, o:on) Initial status : SF LF
	7th	r 0	Real-time rotation speed
Parameter Mode	It decrease the number down		
Jog Mode	Manual stop by button		



Enter button

Parameter Mode	It select or save the chosen display
Jog Mode	Manual start by button



RESET button

It returns to the previous mode. Also it reset the error

5.2 Parameter number group

Number	Main contents	Description
1- 8	Torque	Save the target torque from 1-8
11-18	Rotation speed	Save the rotation speed for P1-P8
21-28	Max turn	Save the limit number of turn for P1-P8 (It stop at the limit number of turn and torque)
31-38	Min. rotation turn for OK/NG verification	Save the minimum rotation turn or running time for OK fastening of P1-P8
41-48	Soft start time	Change time to the target speed
51-58	Torque tuning	Individual torque tuning by controller
61-70	offset	Change of offset or functions
71-80	Screw Counter	Screw counter related pattern setting
82	Air Regulator	Range :0-1, Initial : 1 (0 : No use, 1 : Use)
100-139	Model data	Memory of model data
140-159	Multi sequence	Memory of Multi sequence
160-167	Error history	The latest error number record from P130 to 137
168	Model Number	Memory of controller model number
169	Version	Firmware version

5.3 Preset number and parameters

The preset numbers from 1 to 8 are effected together with parameter 1~8 for torque, parameter 11~18 for speed, parameter 21~28 for max. angle, parameter 31~38 for min. angle, parameter 41~48 for soft start and parameter 51~58 for torque tuning.

	1st data	2nd data	3rd data	4th data	5th data	6th data
Preset no.	Torque	Speed	Max angle	Min angle	Soft start	Torque tuning
1	P1	P11	P21	P31	P41	P51
2	P2	P12	P22	P32	P42	P52
3	P3	P13	P23	P33	P43	P53
4	P4	P14	P24	P34	P44	P54
5	P5	P15	P25	P35	P45	P55
6	P6	P16	P26	P36	P46	P56
7	P7	P17	P27	P37	P47	P57
8	P8	P18	P28	P38	P48	P58

The data from 3rd to 6th are optional.

The 3rd and 4th data can be used for monitoring fastening quality.

They can be used or not.

5.4 Torque, speed & angle setting (I) - by PC program

Set torque, speed & angle on the PC program and upload to the HDC controller, then parameters will be set in the HDC controller.

Please refer the details to the article 9. PC program, Hi-Manager on page 65.

[HDC setting menu on Hi-manager pc program]



5.5 Torque, speed and Angle setting (II) - on the front panel

Log-in is required whenever controller power is OFF and ON for choosing parameter mode. Once log-in with password, it displays Log-IN on mode circulation.

Password can be changed on P89

All parameters including torque, speed are changed or set in Parameter mode.

Example) Preset #1 - Torque 10Kgf.cm, Speed 1000rpm
FND shows " Preset no. - Torque "



Button click	FND display
Initial	1A 15.0 Auto(Work)
1 MODE	L 0 Log-in PW
2 [Left Arrow]	Log in Log-in
3 MODE	PARA Parameter mode
4 [Left Arrow]	P 1 Parameter 1
5 [Left Arrow]	15.0 Current value
6 [Left Arrow] [Down Arrow] 5time	10.0 New value
6 [Left Arrow]	SAVE Save new
7 [Left Arrow] [Up Arrow]	P 11 Parameter 11 for speed
8 [Left Arrow]	1000 current value
Keep the current value which is same as target	
9 RESET	PARA Parameter mode
10 MODE	1A 10.0 Auto(Work) mode

Initial password for Log-in : "0"

5.6 Details of each parameter numbers

1) Torque

Number	Unit	Range	Initial
P1~8	0.01 (Kgf.cm)		
Description	Each number from P1 to 8 contains the torque value for Preset # 1 to 8. The value of parameter 1 is the target torque saved in Preset # 1. Torque unit can be selected on P61		

2)Preset # display

Number	Unit	Range	Initial
P9~10			
Description	<p>The default setting of preset # can be selected between 1 to 8 on P9 (Initial : 1)</p> <p>Preset # display when the controller power on can be selected one of below on P10</p> <p>"0" : Default setting on P9</p> <p>"1" : Previous preset # before power off</p>		

3) Rotation Speed

Number	Unit	Range	Initial
P11~18	1 rpm		
Description	<p>Each number from parameter 11 to 18 contains the speed value for Preset # 1 to 8. The value of parameter 11 is the target torque saved in Preset #1.</p> <p>Preset #1 have the torque of P1 and speed of P11.</p> <p>The initial speed of each parameter is different depends on the models.</p>		

4) Max Angle control

Number	Unit	Range	Initial
P21~28	0.1 turn (36°)	0 ~ 30.0	0
Description	<p>"0" : No use "0.1~30.0" : Value of rotating turn (angle)</p> <p>Function #1 Angle control stop The driver stops at the set turn(angle) and provide fastening complete OK output signal. If the load reach to the target torque, it stops immediately even before the set turns (angle). Each number from parameter 21 to 28 contains the turn value for Preset # 1 to 8. The value of parameter 21 is the target turn(angle) saved in Preset #1. Preset #1 have the torque of P1, speed of P11 and turns of P21.</p> <p>For example, It have 6.0Kgf.cm in P3, 500rpm in P13 and 5 turns in P23, the driver will run with 500 rpm and stop at 5 turns (1800 degree). But if the driver reach to 6.0 Kgf.cm of the target torque, it will stop immediately at any turn.</p> <p>Function #2 Limit of Fastening angle for NG detection If there is no torque up till the set turn(angle), it will stop and provide NG output signal with the error code E301. This function is useful to protect the screw which is continuously running around the screw hole without engaging.</p> <p>It can be selected between Function #1 and 2 on P40. The latest turns(angle) of fastening can be read on the FND display of front panel by pressing down arrow button 5 times from Working mode.  5 times</p>		

5) Minimum Angle for Fastening Quality control

Number	Unit	Range	Initial
P31~38	0.1 turn	0 ~ 30.0	0
Description	<p>Minimum angle can be set as a threshold point For fastening quality control.</p> <p>"0" : No use "0.1~30.0" : Value of rotating turn (angle)</p> <p>Function #1 No torque up NG after Min. Angle (P78)</p> <p>If the driver stops without torque up after the preset turn, it provide fastening NG output signal with the error code E306. It is most serious mistake by operator which is open found but difficult to be recognized..</p> <p>If the driver stops without torque up before the preset turn, it does not provide fastening NG. Because it is very common operating together with screw feeder. This operation does not have any intention of screw fastening.</p> <p>0" : Disable "1" : Enable on P78</p> <p>Function #2 Torque up NG before Min. Angle (P79)</p> <p>If the driver reach up to the target torque after the set minimum turn, the fastening quality is OK. If it stops at the target torque before the set min. turn, it will provide the fastening NG output signal with the error code E307.</p> <p>This is useful function for detecting wrong engaged and fastened screw.</p> <p>"0" : Disable "1" : Enable on P79</p>		

6) Cycle Reset & key button lock on front panel

Number	Unit	Range	Initial
P29		0 or 1	0
Description	Cycle reset is allowed by the Reset key button on the front panel " 0 " Disable, " 1 " Enable		
P49		0 or 1	0
Description	Front key button lock control on the front panel on the front panel " 0 " Disable, " 1 " Enable		

7) Soft start setting 41 ~ 48

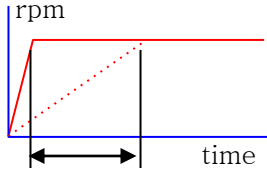
Number	Unit	Range	Initial
P41~48	1 ms	0 ~ 300ms	0
Description	Soft start time to the target speed is selectable from 0 - 300mS for each preset # 		

8) Torque Tuning 51 ~ 58

Number	Unit	Range	Initial
P51~58	1 %	-10 ~ +10%	0
Description	Output torque can be decreased or increased between -10% to +10% for each preset #. This torque tuning value is saved in controller, not in driver. Be careful tuning value when replace the screwdriver.		

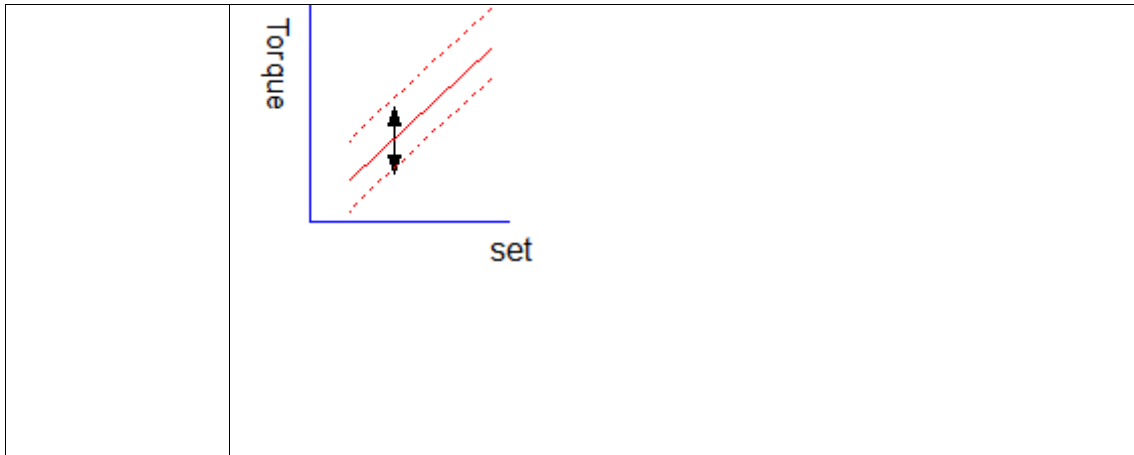

9) Middle count number setting

Number	Unit	Range	Initial
P39		0 ~ 99	0
Description	When the count number reaches to the Middle count number, count complete signal OUT become ON till the total count is completed. Signal types on P70 are ignored on this feature "0" : No use " 1~99" : Middle count number		

10) Function of Max Angle setting of P21 ~ 28

Number	Unit	Range	Initial
P40		0 ~ 1	0
Description	It stops at the set Max angle, and verify as one of below "0" : OK "1" : NG and display Error no 301		

11) COM port select

Number	Unit	Range	Initial
P59		0 or 1	1 from V2.60(2014.10)
Description	One of two communication port should be selected between RS-232C and USB (converted from RS-232C) 0 : USB (converted from RS-232C) 1 : RS-232C		

12) Error display time setting P60

Number	Unit	Range	Initial
P60	sec	0 ~ 10	1
Description	Error display and reset after the below set time "0" : Manual reset by RESET button "1 ~10.0 sec" : Auto reset after set time		

13) Torque unit

Number	Unit	Range	Initial
P61		1 ~ 3	1
Description	It selects one of the torque units below ; "1" : Kgf.cm "2" : N.m "3" : lbf.in [Caution] Change of unit will reset every parameter to factory initial setting. The torque unit should be selected first before parameter setting		

14) Screw type (Clockwise or Counter-clockwise)

Number	Unit	Range	Initial
P62		0 ~ 1	0
Description	It selects one of the screw type below ; "0" : Clockwise "1" : Counter-clockwise The initial value is "0" for "Clockwise" [Caution] Counter clockwise screw is not available for Shockless screwdriver		

15) Torque compensation

Number	Unit	Range	Initial
P63	1%	80 ~ 120	100

Description	<p>If there is difference between set torque and reading torque on the torque tester, the output torque can be adjusted from -20% ~ +20%</p> <p>This compensation effects to whole range of torque.</p> <p>This torque compensation value is saved in screwdriver itself.</p> <p>80 (-20%) ----> 100 (100%) <---- 120 (+20%)</p> <p>Example) 105 : + 5% from the current torque (Increase) 90 : - 10% from the current torque (Decrease)</p>
-------------	---

16) Define of I/O interface

Number	Unit	Range	Initial
P64		0 ~ 4	0
Description	<p>The I/O interface which are connected to Direct Sensor port and 25P I/O port can be used with one of following function.</p> <p>"0" : Manual operation with direct sensor port IN : preset # selecting through 1 to 8 port. OUT : Selected preset # display through 10 to 17 port</p> <p>"1" : Remote control by PLC with 25P I/O port IN / OUT : for PLC</p> <p>"2" : Combined IN/OUT IN : preset # selecting through 1 to 8 port. (Manual) OUT : for PLC</p> <p>"3" : Manual operation with 25P I/O port IN / OUT : for PLC except Start, For/Rev selection on the screwdriver</p> <p>"4" : Connected to " Socket Tray "</p>		

17) Beep sound ON/OFF

Number	Unit	Range	Initial
P65		0 or 1	0
Description	The beep sound can be off 0 : ON 1 : OFF		

18) Time limit for fastening, Loosening and motor stall

Number	Unit	Range	Initial
P66~68	0.1 sec	0 ~ 60.0	
Description	<p>It prevent the continuous running over the preset time in direction of fastening and loosening for safety operation. The driver stops automatically at the preset time and provide the pattern NG with the error code below;</p> <p>P66 : Limit of fastening run time error code - E300 P67 : Limit of loosening run time error code - E302 Initial value = 10.0 sec</p> <p>Also it prevent the continuous time going against the motor stall for over heat protection.</p> <p>P68 : Limit of motor stall time error code - E303 Initial value = 1.0 sec</p>		

19) Reverse control

Reverse can be activated or deactivated

Number	Unit	Range	Initial
P30		0 or 1	1
Description	Reverse rotation control 0 : Deactivated 1 : Activated		

20) FND Display type

Number	Unit	Range	Initial
P69		1 ~ 5	2
Description	<p>One of 5 types of display can be selected.</p> <p>"1" : Preset no. + Speed Example) 1R 100 --> Preset #1- 1,000rpm</p> <p>"2" : Preset no. + Torque [Stop] ↔ Speed [Running] Example) 1R 150 --> Preset #1- 10Kgf.cm</p> <p>"3" : Fastening Torque [Stop] ↔ Preset no.+Torque [Running] Example) 1R098 [Stop] - 1R 100 [Running]</p> <p>"4" : Screw counter [Stop] ↔ Preset no.+Torque [Running] Example) 10c01 [Stop] - 1R 150 [Running] Remain screw no. = 1 (9 screws are tightened)</p> <p>"5" : Screw counter ↔ Preset no.+Torque Example) 10c01 ↔ 1R 150 (Alternately) Remain screw no. = 1 (9 screws are tightened)</p>		

21) COUNT complete signal type at count port (pin 4)

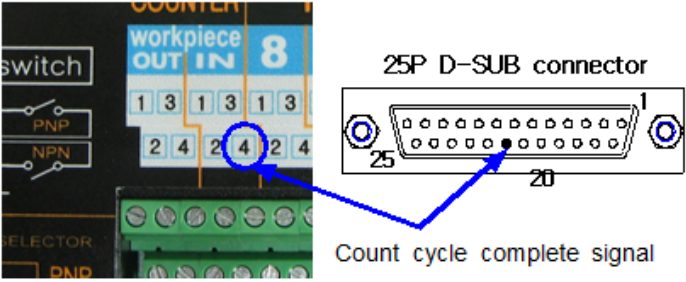
Number	Unit	Range	Initial
P70		0 ~ 3	0
Description	<p>It select the type of Count Finish signal of the Direct Sensor port. (2-Count Start signal 4-Count Finish signal)</p> <div style="text-align: center;">  <p>U-2 Interface Box Count complete</p> </div> <p>"0" Count complete (500ms) _____</p> <p>"1" Torque OK + Count complete _____ Fastening OK Reset</p> <p>"2" Count complete (100ms) _____</p> <p>"3" Alarm when screw missed in a cycle</p> <p>"0" : It provide 500ms of pulse type count complete signal after fasten all set numbers.</p> <p>"1" : It provide every pulse(0.5s) signal of torque OK and count complete signal after fasten all set numbers. The count complete signal will be off after reset of count number when next work piece come in.</p> <p>"3" : It provide 100ms of pulse type count complete signal after fasten all set numbers.</p> <p>"4" : It provide 100ms of pulse type alarm signal when screw missed in a cycle.</p>		

22) Function of F2 button of screwdriver related with Counter port

Number	Unit	Range	Initial
P71		0 ~ 3	0
Description	<p>It selects the function of F2 button on the screwdriver</p> <div style="text-align: center;">  <p>F2 button</p> </div> <p>0 : Disable 1 : Cancel last count 2 : Screw feeding signal (through torque-up output 3 : Preset/Model # select by F1(up) & F2(down) --> refer to P73</p> <p>Depend on the function selected, the F2 button on the screwdriver works differently as below</p> <p>"0" Lock the button "1" Delete 1 number of screw counting (-1) "2" Screw shooting pulse signal through pin no.15 of Torque-up port (OUT) for an external auto screw feeding system. "3" By pressing F1 button, the prese # goes up to no. on P73 by pressing F2 button, the preset # goes down to no.1</p>		

23) Multiple hit

Number	Unit	Range	Initial
P72		1 ~ 5	1
Description	Clutch activating times can be selected from 1 to 5. It choose "1" : Single hit "2" : Double hit "3" : Triple hit "4" : Quadruple hit "5" : 5 times hit		

24) Number of preset # select by F1 & F2 button

Number	Unit	Range	Initial
P73		1 ~ 8	8
Description	The number of selectable preset no. can be set. When number 3 is selected on P71, F1 button can select up to preset #3, and F2 button can select down to preset #1		

25) Auto sequence of preset

Number	Unit	Range	Initial
P74		0 or 1	0
Description	Total 20 preset # can be programmed for automatic sequential fastening when Model feature on P75 is enabled. "0" : Disable "1" : Enable		

26) Model select for screw count

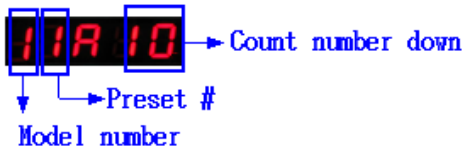
Number	Unit	Range	Initial
P75		0 or 1	0
Description	<p>HDC has 8 different models for screw count. Each model is programmable with the max. 20 preset numbers in a cycle process. To use this feature, P74 should be enabled "0" : Disable "1" : Enable * Models can be selected by the I/O interface or F1/F2 button on the screwdriver with Enable(3) setting on P71. Display is also changed as below for this feature.</p> 		

27) Count start(IN) & finish(OUT) signal type

Number	Unit	Range	Initial
P76		0 ~ 3	0
Description	<p>For monitoring and qualifying the number of screws, HDC should receive the count START signal and STOP(Finish) signal in some application. HDC provides the count complete signal out when it reach to the target number.</p> <p>HDC provides 4 different types of signal to be selected. The sensor or switch can be connected to HDC directly for Start signal.</p> <p>"0" : Auto reset. The count number is reset to the target number automatically after "0" .</p> <p>"1" : If the count number shows "0" during the ON status of the count Start signal, it provide the count COMPLETE OUT signal. If the Start signal is turned OFF before the count number "0", it provide the count NG OUT signal</p> <p>"2" : It start count with a pulse type of signal till the set time on P77. It the count does not reach to the target within the set time, it is NG. If there is no time set on P77, There is no time limit to count stop (finish)</p> <p>"3" : It start count with a pulse type of signal. If the count does not reach to the target before 2nd pulse type of signal, it is NG. Refer to the article 5.13.2 for details</p>		

28) Time LIMIT from Count start (P76_"2" selected)

Number	Unit	Range	Initial
P77	0.1 sec	0 ~ 999.9	0
Description	<p>The fastening time limit from Count START for NG judgment. The fastening work should be finished within the set time. Otherwise, the work-piece will leave the working area. * Refer to the article 5.13.2 for details</p>		

29) No torque-up NG by Min. set angle(turn) on P31~38

Number	Unit	Range	Initial
P78		0 ~ 2	0
Description	<p>No torque-up NG by the set turn on P31~38 --> error code E306</p> <p>"0" : Disable "1" : No torque up error after Min angle "2" : No torque up error on all cycle</p>		

30) Torque-up NG before Min. set angle(turn) on P31~38

Number	Unit	Range	Initial
P79		0 ~ 1	0
Description	Torque-up NG before the set turn on P31~38 --> error code E307 "0" : Disable "1" : Enable		

31) Time setting for SLEEP mode

Number	Unit	Range	Initial
P80	1 min	0 ~ 60	15
Description	If the unit is not used for the set time, the controller turns off the control mode and keep SLEEP mode. With any key or button pressed, it will wake up immediately. "0" : No use, "1~60" : time to Sleep 		

32) Motor acceleration

Number	Unit	Range	Initial
P81	1 ms	10 ~ 200	20
Description	The motor increase the rotation speed up to the target in the set time . It works for all preset #.		

33) Parameter reset to the factory setting

Number	Unit	Range	Initial
P83		0 or 77	0
Description	<p>Every parameter will be reset to the factory setting.</p> <p>Put the password "77" on parameter 83 and Enter for reset to factory setting.</p> <p>- Controller should be reset to the factory setting when the connected driver is replaced to other model.</p> <p>- Controller should be powered off whenever completed resetting.</p>		

34) F1 Button on screwdriver (P84 : HDC-40i only)

Number	Unit	Range	Initial
P84		0 ~ 1	1
Description	<p>Enable or disable of the F1 button function of selecting preset # 1 to 8 (move up in circulation)</p> <p>"0" : Disable, "1" : Enable</p> <div style="text-align: right;">  </div>		

35) Reverse torque control

Number	Unit	Range	Initial
P85		0 ~ 1	1
Description	<p>The auto shut-off at torque up signal can be disabled for reverse rotation.</p> <p>0 : Disable 1 : Enable</p>		

36) Auto Fastening Data output

Number	Unit	Range	Initial
P86		0 ~ 1	0
Description	Monitoring data can be output automatically through USB(RS-232) without data request command protocol 0 : Hi-Manager 1 : Auto output Enable		

37) Fastening Torque (Converted torque) Tolerance setting

Number	Unit	Range	Initial
P87	%	1 ~ 10	5
Description	If the converted torque is over than the setting value(%), NG (Er 308) will be displayed "0" : No use "1~10%" : +/- tolerance limit from target		

38) P88 Driver Lock by I/O management

Number	Unit	Range	Initial
P88		0,1,2	0
Description	When driver lock signal is provided by I/O, lock can be selected "0" : Both direction "1" : Fastening "2" : Loosening		

39) Password

Number	Unit	Range	Initial
P89		0 ~ 9999	0

Description	Factory setting password is " 0 " at the initial. Password can be changed between 0 - 9999 on P89.
-------------	---

40) Screw numbers on each models

Number	Unit	Range	Initial
P90-97		0 ~ 20	0
Description	Screw numbers on each model 1 to 8 is saved on P90 to 97 P90 : Screw # of Model 1 P91 : Screw # of Model 2 P92 : Screw # of Model 3 P93 : Screw # of Model 4 P94 : Screw # of Model 5 P95 : Screw # of Model 6 P96 : Screw # of Model 7 P97 : Screw # of Model 8 Maximum screw number is 20 for each model.		

41) Start signal OFF delay time

Number	Unit	Range	Initial
P99		0 ~ 1000	0
Description	Customer lost the fastening OK output when operator release start lever just before torque up, but clutch was activated by inertia. Range : 0 - 1,000 mS factory setting : 10mS		

42) Error history (except the pattern error)

Number	Unit	Range	Initial
P160~167			

Description	The total 8 latest errors except the pattern error is recorded from P160 to P169.	
	P160 : The last error	P164 : The last error -4th
	P161 : Before the last error	P165 : The last error -5th
	P162 : The last error -2nd	P166 : The last error -6th
	P163 : The last error -3rd	P167 : The last error -7th

43) Others (Not changeable)

No	Name	Range	Initial	Description
P82	Air Regulator	0-1	1	0: No use 1: Use
P100-139	Memory area of model data			
P140-159	Memory area of multi sequence			
P168	Memory of controller model no			
P169	Software version			
The rest parameter numbers are spare or vacant address.				

5.7 Error code

1) System error

code	Error	Description	How to reset
100	Air pressure	The monitored air pressure is less or more than $\pm 5\%$ of the target over 3 seconds,	RESET button.
101	Motor hall sensor Open	No motor hall sensor signal from the screwdriver	RESET button
110	AMP Over Current	Over current on AMP board circuit by over load or wrong mechanical load.	Auto reset after 1 sec.
111	SMPS Fault by overload	Overload protection over 8A on SMPS power supply circuit.	Power Off, and On after 1 min.
112	Overload alarm	Over 5A over 1sec.	Auto reset after 1 sec.
113	Driver overheat	Over 80 °C inside the driver	Auto reset below 80 °C
114	Over Speed	Over rotation speed than the set value. Check the cable connection.	Auto reset after 1 sec.
115	Wrong model detected	Wrong model information of EEP-ROM in driver. Check the EEP-ROM damage or communication failure	RESET button
116	Wrong offset detected	Wrong offset value over the range in the driver is detected Check the EEP-ROM damage or communication failure	RESET button
117	Not compatible driver connected	The connected driver model is not recognized by HDC. HDC latest firmware upgrade is required	RESET button

118	Motor run failed	Even the start signal is effective, motor does not run	Repair required
-----	------------------	--	-----------------

2) Communication error (HDC ↔ driver)

code	Error	Description	How to reset
200	Parameter reading error	Reading failure of the parameter from the EEP-ROM of the driver	RESET button
201	Parameter Checksum error	The read parameter is wrong by the checksum routine	RESET button
202	Initializing error	Initializing error at the booting	Power OFF-->ON
203	Communication error	Failure during communication with driver	Auto reset after set time
204	Communication time out	Communication failure over 1 sec.	Auto reset after set time
205	Wrong parameter setting	Parameter on controller is wrong for the connected screwdriver	Auto initialize

3) Pattern error

code	Error	Description	How to reset
300	Fastening time limit	Over the fastening time limit on P66	Auto reset after set time
301	Fastening time over	Time over the set time on P21~28	Auto reset after set time
302	Loosening time over	Over the loosening time limit on P67	Auto reset after set time
303	Motor lock time over	Over the motor lock time limit on P68	Auto reset after set time
304	Time over in screw counting	Over the time limit of screw counting on P77	Auto reset after set time
305	Screw missing	When the work-piece moves out of the working area without complete number of fastening, it provide alarm for 3 seconds and display the latest number. It can be clear to "0" by pressing RESET button.	Auto reset after set time or RESET button
306	No torque-up	When the driver stops without torque-up after set time in P31~38	Auto reset after set time
307	Time laps	Torque up too earlier than the time on P31~38	Auto reset after set time
308	Torque NG	Monitored fastening torque(converted torque) is out of the set tolerance	Auto reset after set time

5.8 Preset number selecting by sensor

The 8 sensor ports on U-2 Interface Box are linked to 8 preset numbers through 25P I/O interface. These ports are designed for sensors to be wired directly. When the sensor 1 is activated, the preset no.1 is selected accordingly. The configuration of 25P I/O port is different by the setting on P64.

[P64 Setting] Select " 0 "

"0" : Reset number selecting by Sensor "1" : Remote control I/O for PLC

The sensor can be replaced to the switch (mechanical switch)

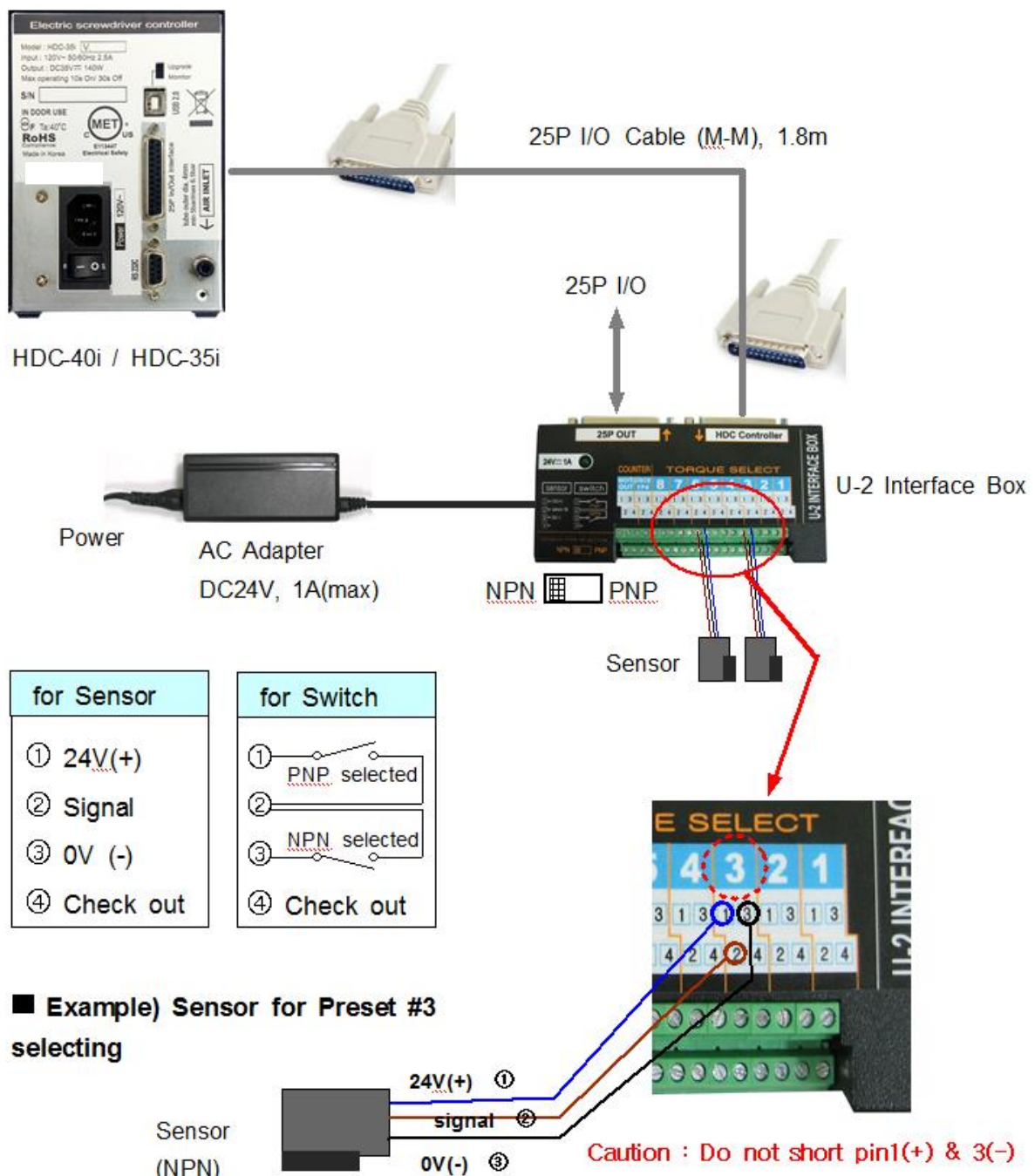

5.9 Wiring example of check out signal output

The pin no.4 (status check out signal) of each sensor port 1 to 8 is useful to check which preset number is selected by the LED, if LED is wired. The LED will require the external or internal DC power source for lighting.

The wirings for both power sources are as below

[P64 Setting] Select " 0 "

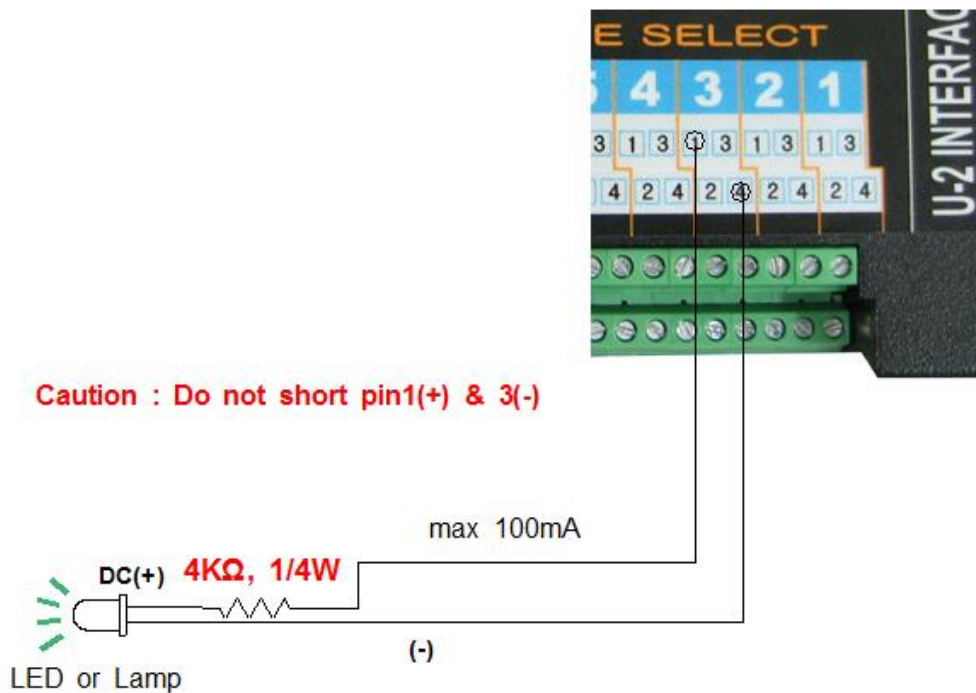
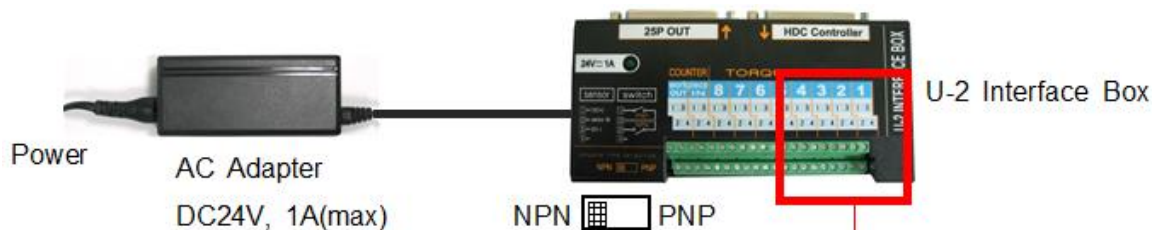

Depend on the LED or lamp, the resistance value should be calculated for protection of LED

5.10 Preset number selecting by 25P I/O port

The 25P I/O port is useful interface with the PLC. The PLC can select one of the 8 preset numbers through 3 pins. It can not be used together with the direct sensor port

For 25P I/O port, choose "1" on the parameter P64.

By binary coding with 3 pins (pin no.1,2 and 3) among 25 pins, it make 1 to 8 decimal preset number. The torque selecting code should be before the Start signal.

1) Binary coding with 3 pins

Preset no.	pin ③	pin ②	pin ①	pin ⑧
1	0	0	0	
2	0	0	1	
3	0	1	0	
4	0	1	1	
5	1	0	0	
6	1	0	1	
7	1	1	0	
8	1	1	1	
Multi A			0	1
Multi B			1	1

5.11 25 PIN I/O configuration

The configuration of 25P I/O port is different by the setting on P64.

[P20 Setting]

"0" : Torque selector by Sensor

"1" : Remote control I/O for PLC

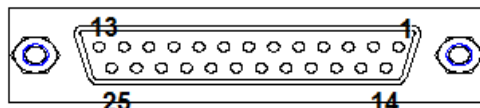

"2" : Torque selector by Sensor (Input) + Remote control I/O for PLC (Output)



25P D-SUB connector



5.11.1 25 PIN I/O configuration (|) - for Preset # selecting by sensors

[P20 Setting] " 0 " : Torque selector by Sensor

PIN no.	Configuration	IN / OUT
1	Torque select IN1	<p>INPUT (to Controller)</p> 
2	Torque select IN2	
3	Torque select IN3	
4	Torque select IN4	
5	Torque select IN5	
6	Torque select IN6	
7	Torque select IN7	
8	Torque select IN8	
9	Reset (include cycle reset) or Work-piece move OUT from area (P76 "3" selected)	
19	Work-piece move IN to area	<p>OUTPUT (to Controller)</p> 
23	x	
24	x	
10	Status of torque select OUT1	
11	Status of torque select OUT2	
12	Status of torque select OUT3	
13	Status of torque select OUT4	
14	Status of torque select OUT5	
15	Status of torque select OUT6	
16	Status of torque select OUT7	
17	Status of torque select OUT8	
18	ALARM (NG)	
20	Cycle count complete	
25	Fastening OK OUT	
21	Output COM	
22	Input COM	

5.11.2 25P I/O configuration (II) - for PLC



[P20 Setting] - " 1 " : Remote control I/O for PLC

PIN no.	Configuration	IN / OUT
1	Torque select IN1	<p>INPUT (to Controller)</p> 
2	Torque select IN2	
3	Torque select IN3	
4	START	
5	LOCK	
6	F/R (Forward 0, Reverse 1)	
7	Model select IN3 or Screw type (Clockwise 0, counterclockwise 1)	
8	Torque select IN4 for Multi sequence	
9	Reset (include cycle reset) or Work-piece move OUT from area (P76 "3" selected)	
19	Work-piece move IN to area	
23	Model select IN1	<p>OUTPUT (to Controller)</p> 
24	Model select IN2	
10	Error code OUT1	
11	Error code OUT2	
12	Error code OUT3	
13	Error code OUT4	
14	Status of F/R OUT (F:0, R:1)	
15	Torque up	
16	Status of Motor Run OUT	
17	READY	
18	ALARM (NG)	
20	Cycle count complete	
25	Fastening OK OUT	
21	Output COM	

22	Input COM	
----	-----------	--

**5.11.3 25P I/O configuration (III) -
for Torque selector by Sensor (Input) + PLC (Output)**

[P64 Setting] - " 2 " : Combined

PIN no.	Configuration	IN / OUT	
1	Torque select IN1	INPUT (to Controller) 	
2	Torque select IN2		
3	Torque select IN3		
4	Torque select IN4		
5	Torque select IN5		
6	Torque select IN6		
7	Torque select IN7		
8	Torque select IN8		
9	Reset (include cycle reset) or Work-piece move OUT from area (P76 "3" selected)		
19	Work-piece move IN to area	OUTPUT (to Controller) 	
23	x		
24	x		
10	Error code OUT1		
11	Error code OUT2		
12	Error code OUT3		
13	Error code OUT4		
14	Status of F/R OUT (F:0, R:1)		
15	Torque up		
16	Status of Motor Run OUT		
17	READY		
18	ALARM (NG)		
20	Cycle count complete		
25	Fastening OK OUT		
21	Output COM		

5.11.4 25P Interface schematic – INPUT

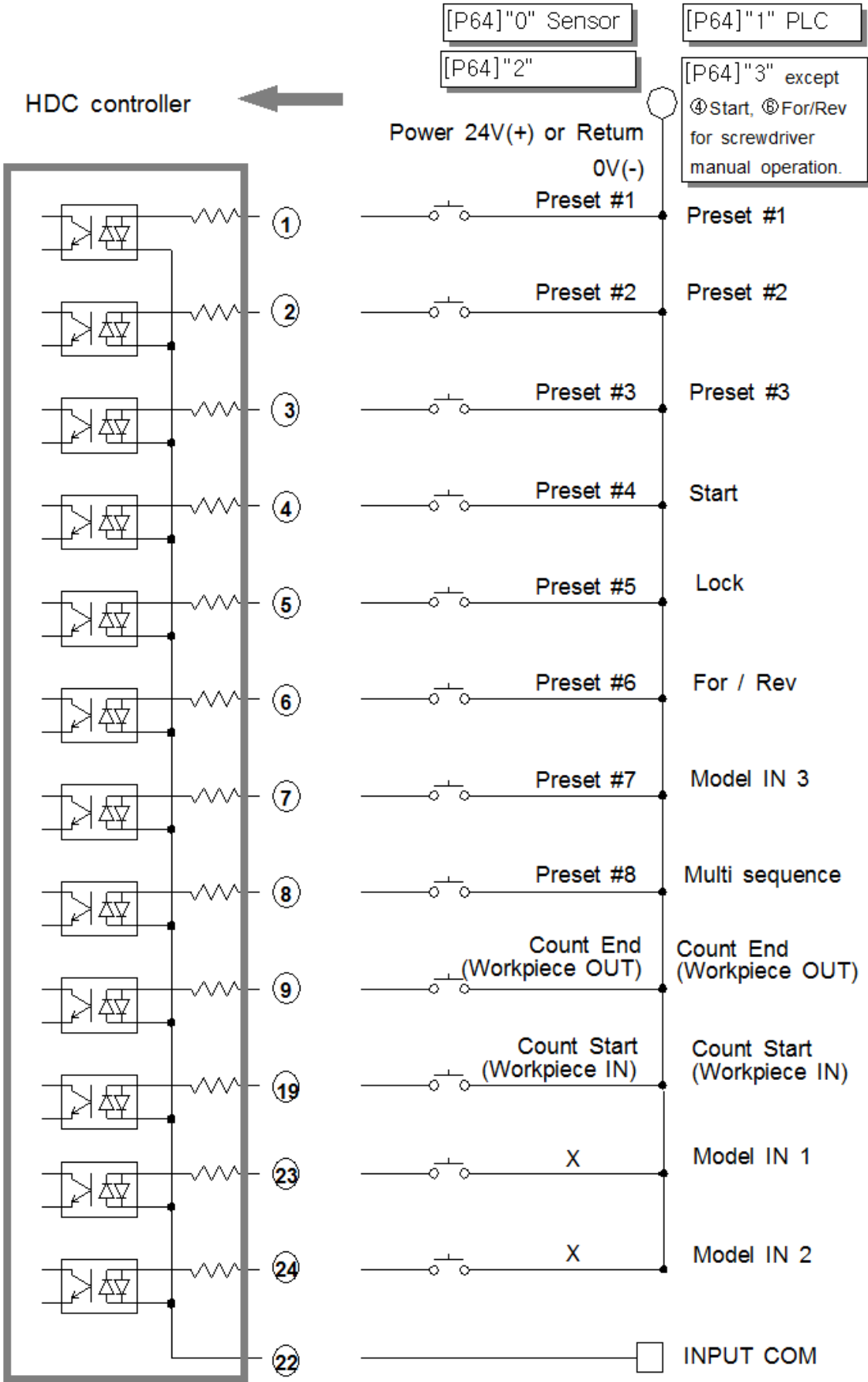

Return 0V(-) or Power 24V(+)

5.11.5 25P Interface schematic - OUTPUT

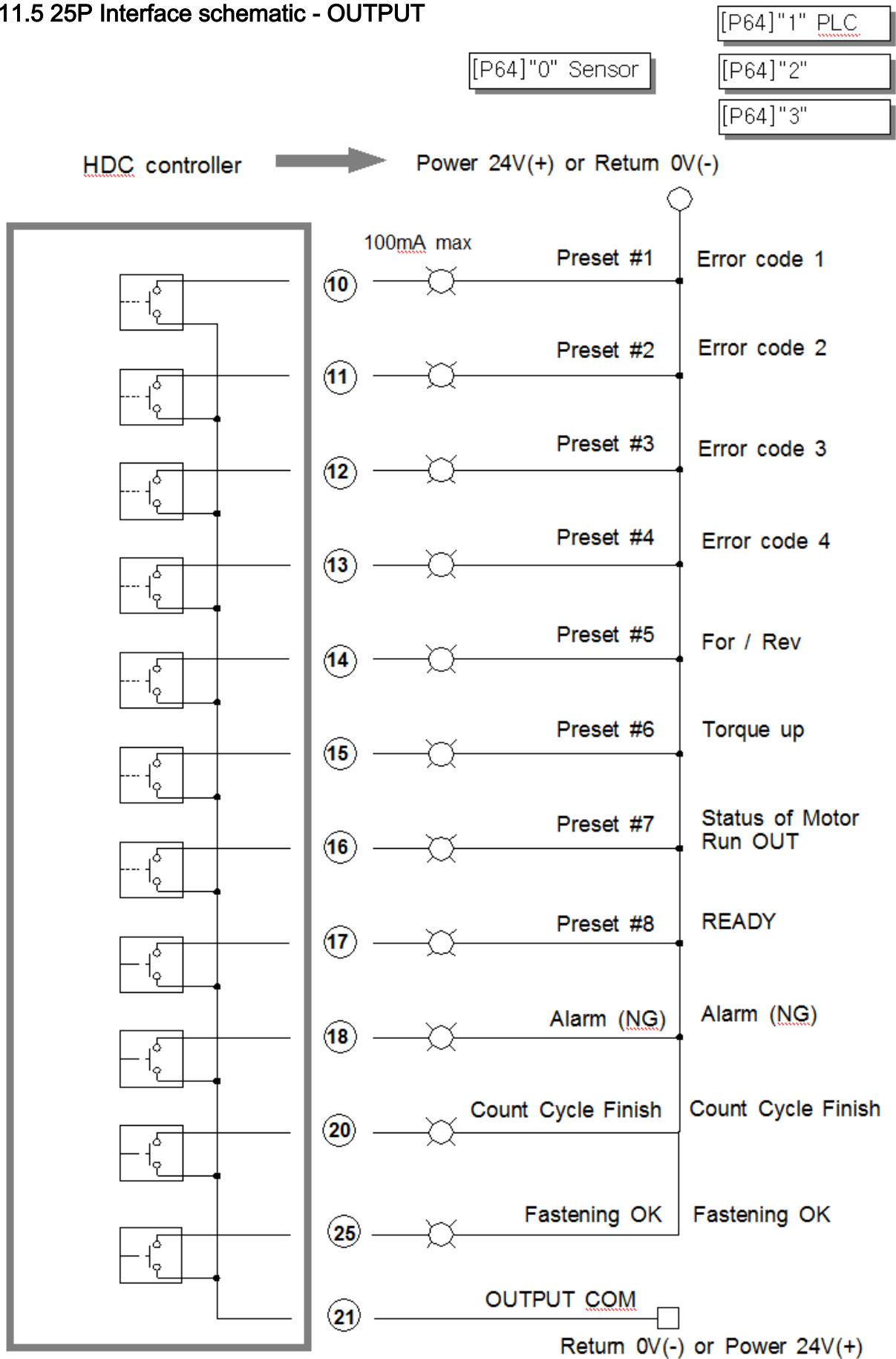

5.11.6 Wiring of the Alarm signal to the Tower Lamp

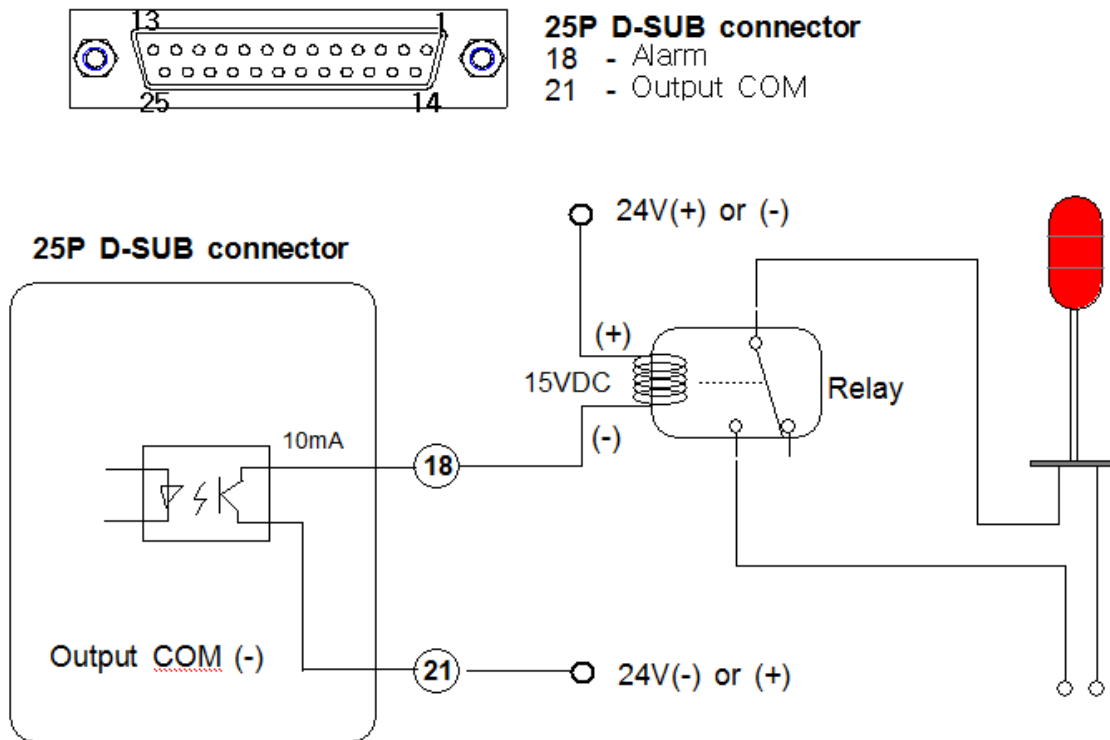

5.11.7 Error code pin composition on 25P Output _ [P64] "1" PLC selected

Error code	pin 13	pin 12	pin 11	pin 10
100	0	0	0	1
101	0	0	1	0
110,112	0	0	1	1
111	0	1	0	0
308	0	1	0	1
113	0	1	1	0
114	0	1	1	1
118	1	0	0	0
200,201,202,203,204	1	0	0	1
304	1	0	1	0
301	1	0	1	1
305	1	1	0	0
303	1	1	0	1
306	1	1	1	0
307	1	1	1	1

5.12 25PIN I/O timing chart

1) Fastening OK

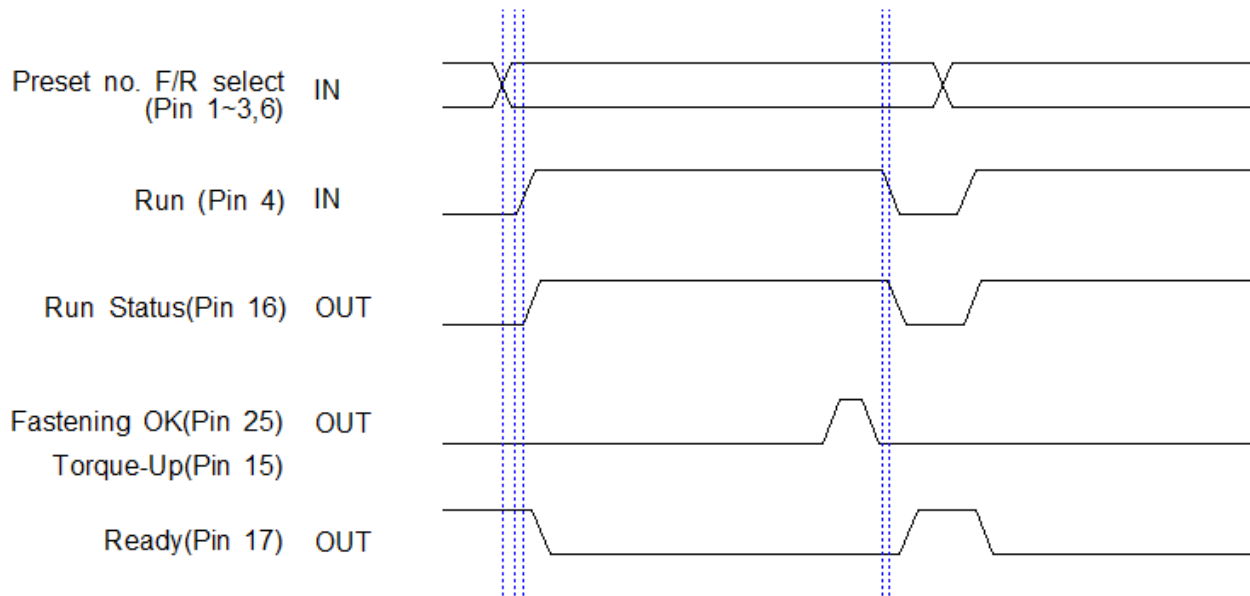

2) Fastening NG

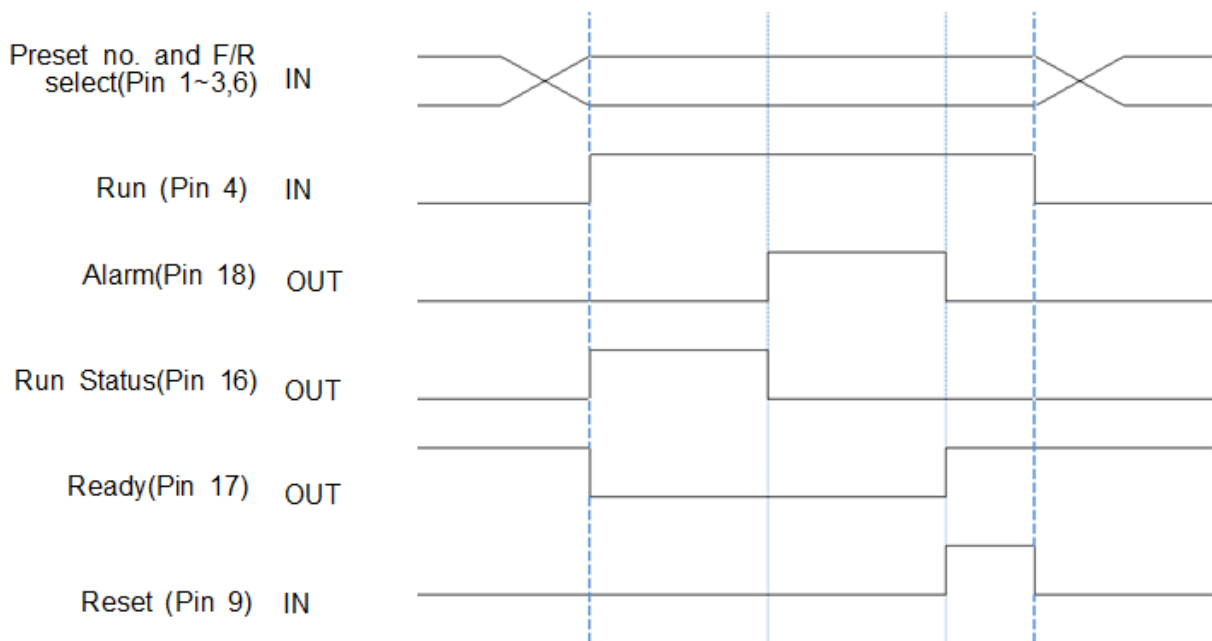

5.13 Built-in Screw Counter (patent)

The screw counter has two basic features.

- ① Fastening quality verification (OK/NG)
- ② Monitoring the number of screws and verification OK/NG

It has the additional features as below

- ① 4 different type of Count Start and Finish signal (selectable)
- ② Real time monitoring by PC program
- ③ Error code display and monitoring basic data including fastening time, angle

5.13.1 Fastening quality verification (OK/NG)

It count down one by one from the total target number with OK fastening.

1) Fastening OK

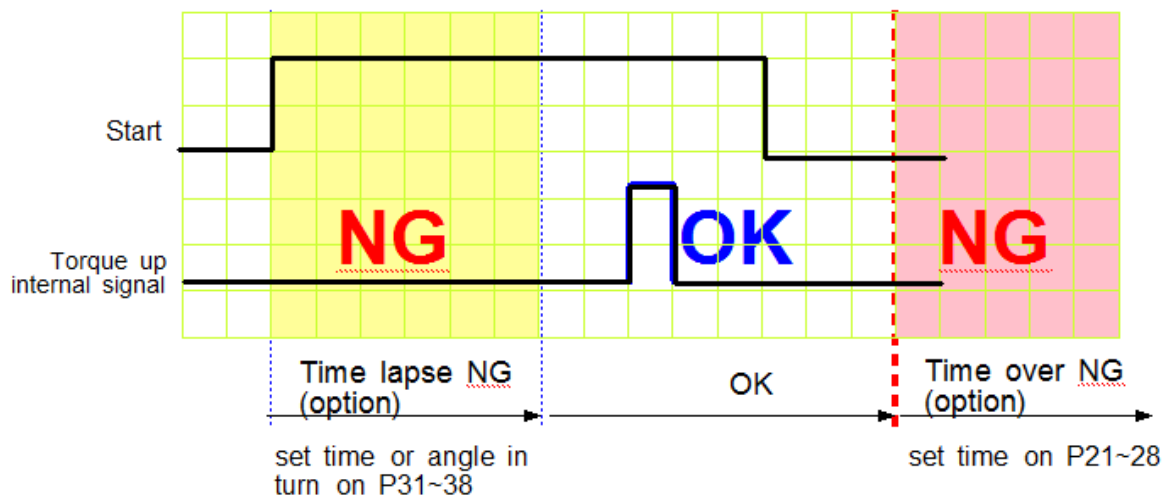

- The driver is designed to stop automatically when there is a torque up internal signal. The fastening with the automatic stop is OK. If there is set time on P31~38, The only fastening over the set time or angle will be OK.

- If there is target fastening time or angle on P21~28 for NG verification, driver stops at the set time or angle, and verify it as NG

- If there is total run time limit on P66, all run time is limited at the set time. The driver will stop at the set time, and provide E304 error code

2) Fastening NG (Time lapse) Error Code Display : **E r 3 0 7**

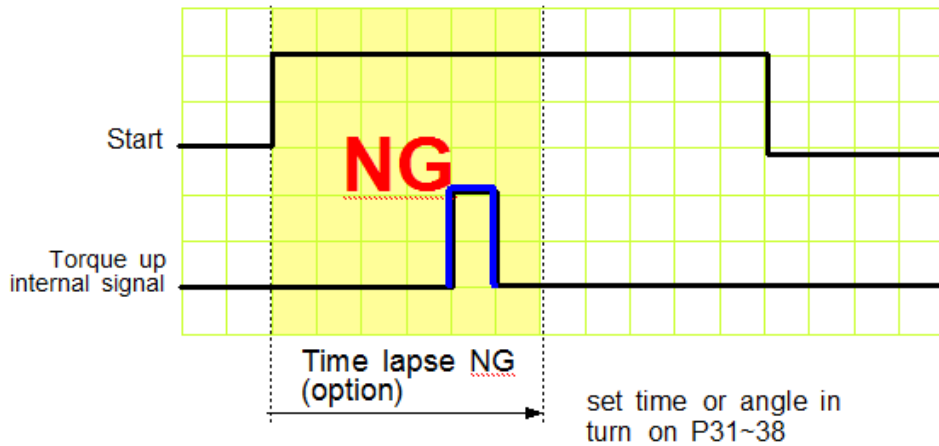

If the driver stops by the torque up internal signal before the set time or angle in turn on P31 ~ 38, it will be NG (Time lapse)
 Even the torque reached to the target, the screw is not fastened enough.
 The FND display Er307 for 1 sec and and reset automatically.

3) Fastening NG (No Torque up) Error Code Display : **E r 3 0 1**

All No torque-up fastening does not effect to screw counting at all.
 If the parameter P79 is checked on " USE", the No torque up fastening over set time or angle in turn on P31~38 makes NG verification.

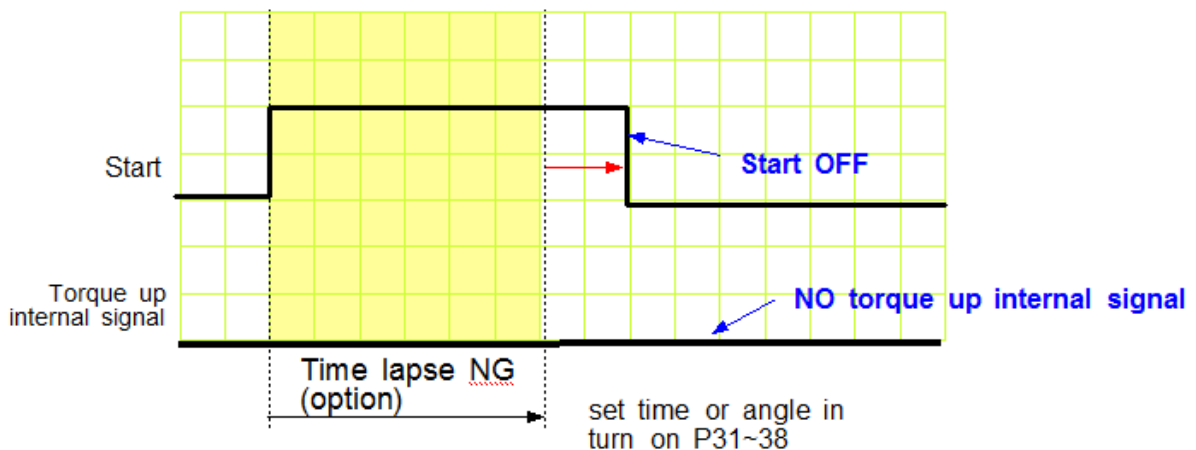

The operator sometimes release the start lever just before the torque reach to the target. This is distinguished from the short idling run for screw pick-up from the screw presenter. And it is one of the serious quality failure.

5.13.2 Count Start & Stop signal to HDC (parameter P76)

For HDC to verify the missing screw, it require two basic signals ; Count start and stop. It will count the number of screw with Start signal, and verify OK as soon as it reach to the target number, or NG with Stop signal when the fastened number of screw is less than the target.

HDC provides Count complete OK or NG Output signal, too.

The count complete OK means that a process of cycle is finished.

There are 4 different type of the Count start/Stop signals which is selectable on parameter P76 as below. Depend on the working area, one of them can be chosen.

The signal port for Count Start and Count complete OK is located on Count port of the back panel of HDC.

*** Refer to the page 47, 48 for wiring.

It is same as the preset no. selecting by sensor

1) Auto Reset (select "0" on P76)

When the count number reach to the target, it display " 0 " (remained number) on FND and reset the number to the target immediately.

Example) the target screw number is "10"

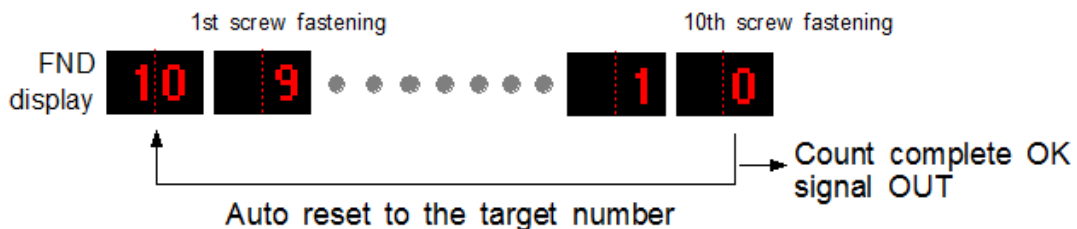

HDC starts to count the number of screw fastening without any signal from the external to HDC.

2) One Long lasting pulse type signal (select "1" on P76)

It starts counting the screw number from the ON signal edge and keep counting on ON status. If the number reaches to the target on ON status, it provide the Count complete OK out signal. It verify the NG when the ON status turned OFF which means that the fastening work is finished, because the work piece left the working area. If there is still remained number over 1 on FND, it verify it NG with **error code Er305**

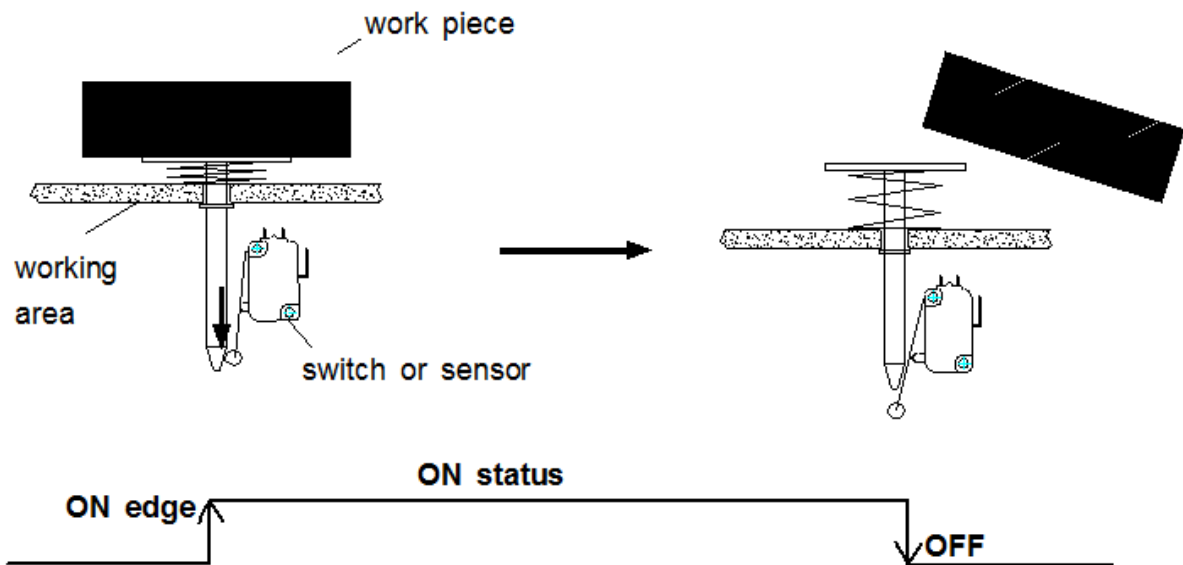

The display is reset to the target number when the Count Start signal is turned ON again

Example) the target screw number is "10"

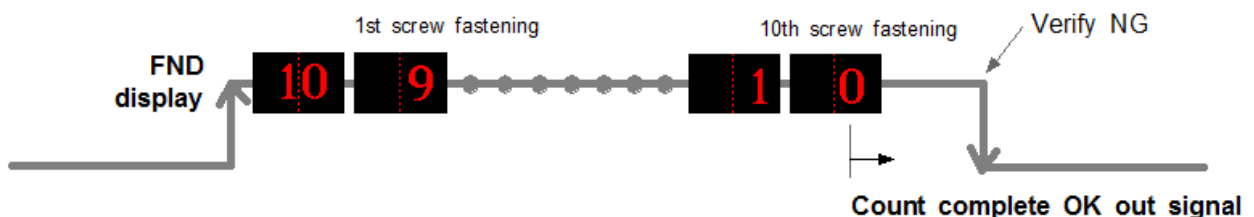

The above switch can be replace to the sensor as shown on right

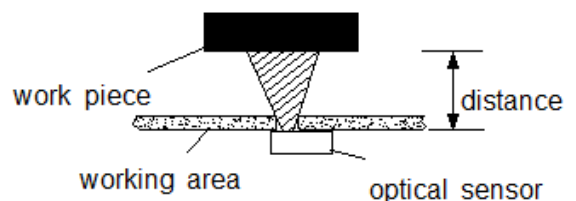

3) One Pulse type signal (select "2" on P76)

It starts counting number of screw on receipt of pulse signal. There is no Count Stop signal. When the counting reach to the target, it will provide the count complete OK output signal.

But if the time after start is limited on P77, HDC will verify NG at the set time.

If the fastening is not complete till the set time, it will verify NG with the error code

Er 3 0 5 for 3 seconds and will display the number remained.

It can be clear to the target by pressing RESET button

Example #1) Count start pulse signal with time limit

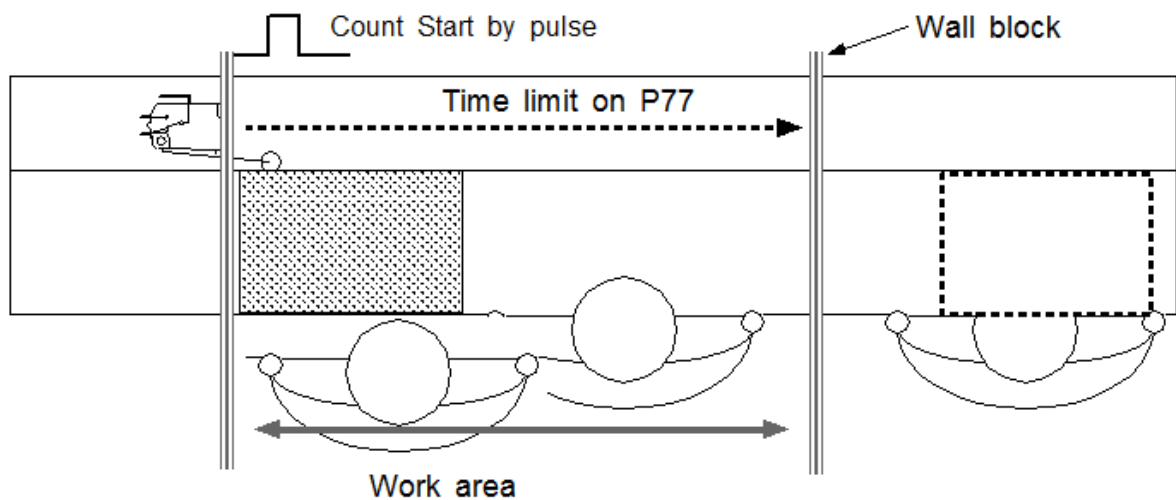

Example #2) Count start pulse signal **without** time limit

Without the fastening time limit after Start on P77, it can be a useful application with a pallet conveyor system with stopper as shown below. The stopper does not go down keeping the work piece in work area, if there is no Count complete OK signal from the HDC.

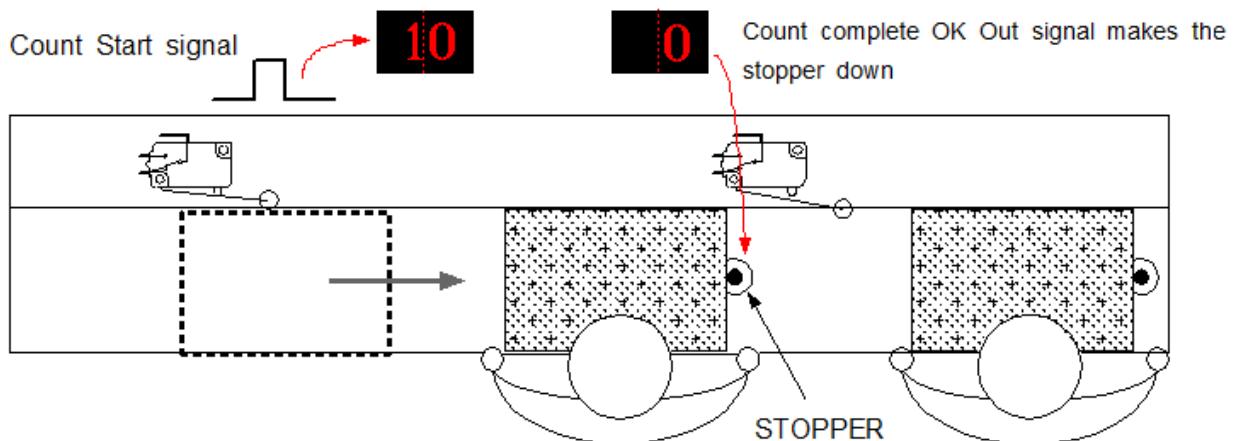

4) Two pulse type signal (select "3" on P76)

As shown the picture below, there are two pulse type signals. The left one is for Count Start and the right one is for Count stop signal. The right one detects work piece moving out of work area for verifying NG. If the count number does not reach to the target, it will provide error code **E r 3 0 5**

The Count Start sensor or switch is wired to the COUNT port on the back.
The Count Stop sensor or switch is wired to pin 9 of the 25P I/O connector.
(refer to the page 37,38 for details)
The preset no. selecting on P64 should be "0", direct Sensor port

*** Refer to the page 47, 48 for wiring.

It is same as the preset no. selecting by sensor

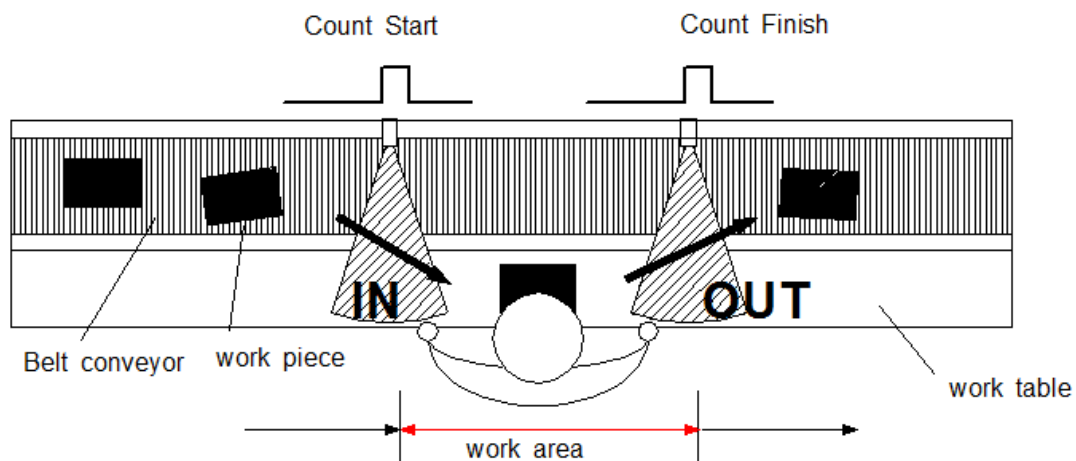

The above two sensors can be replaced to switches.

5.13.3 Wiring of Count Start & Stop

1) Count Start & Stop signal through U-2 Interface Box

U-2 Interface Box is very useful to connect sensors or switches for selecting preset #.

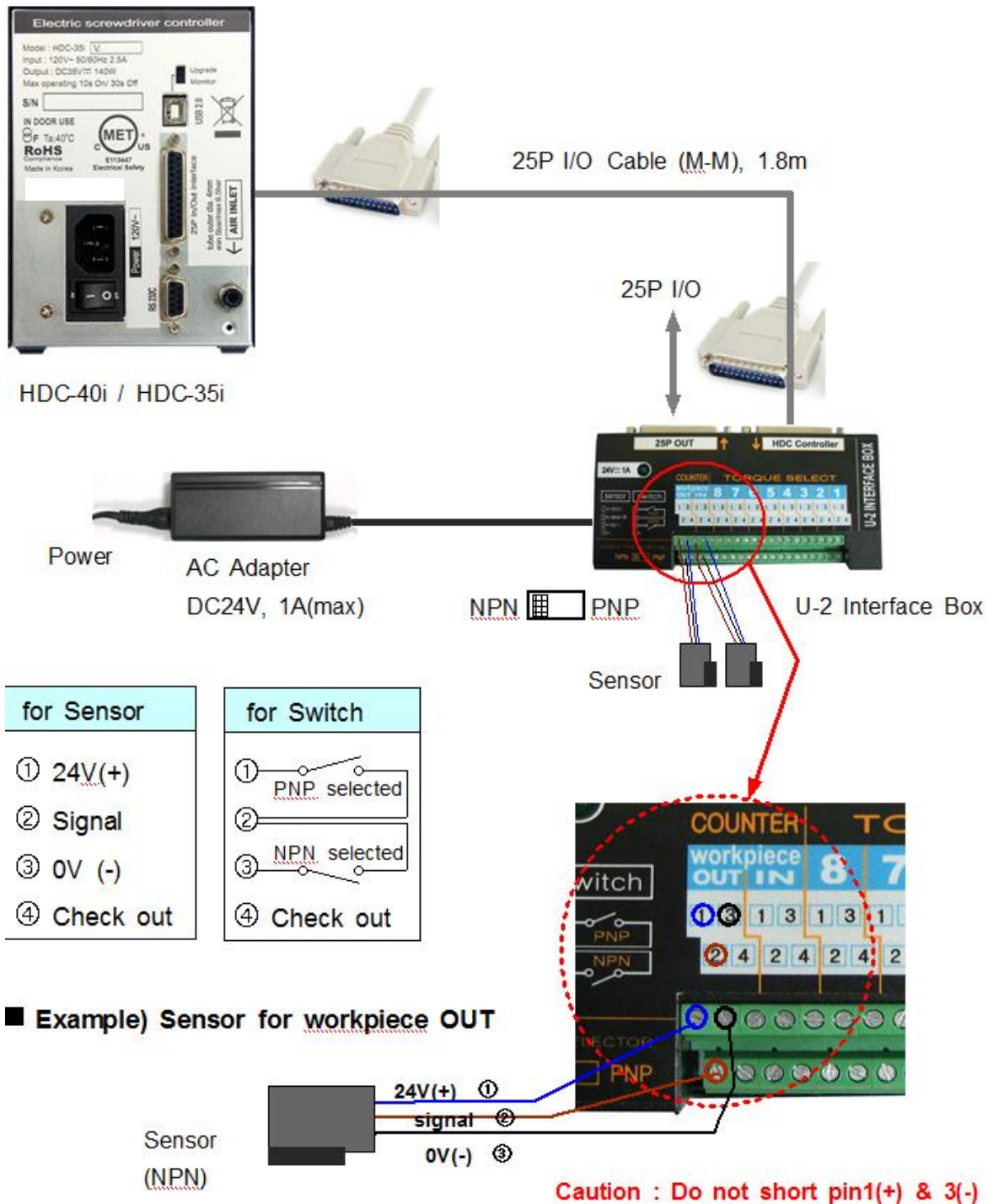

2) Direct wiring to 25P I/O interface port

■ SENSOR (NPN type)

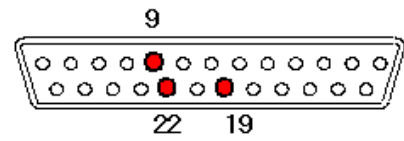
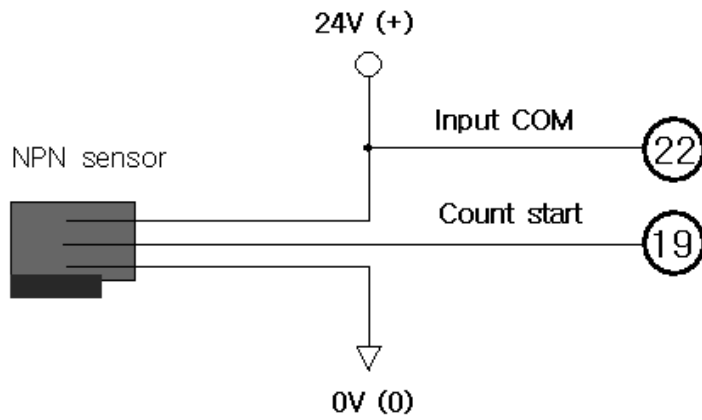

25P I/O D-Sub connector

■ SENSOR (PNP type)

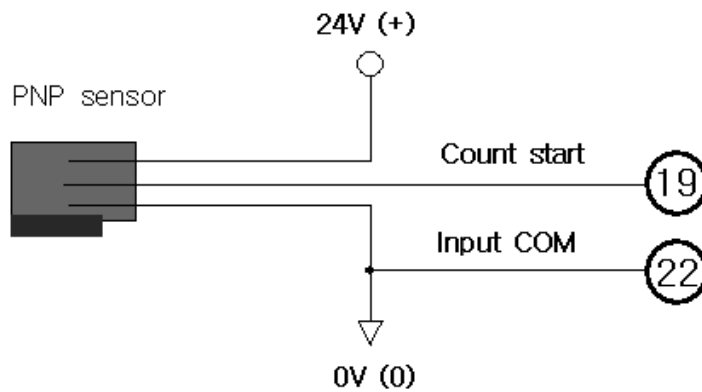

■ Switch

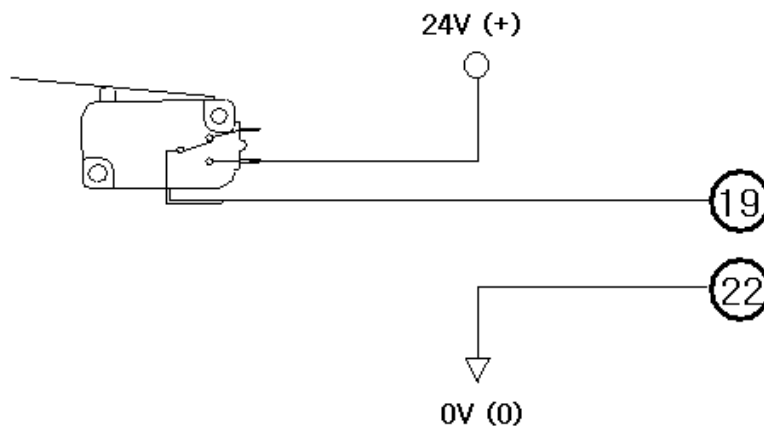

5.13.4 Operation of Screw counter on HDC

The screw counter function of HDC controller can be used as a single fastening quality monitoring device.

■ Parameter setting for single

parameter no.	Setting
* P71 optional	select "1", COUNTER
└─┬─┘ P21 ~28	Key in the maximum turn on P21 to 28 for fastening OK of Preset no. 1 to 8
	P31 ~38
* P90 ~97	Key in the numbers of screw to count for 8 models ex) Key in "10" on P90 --> 10 screws on model #1
* P76 └─┬─┘ P77	select one of Count Start signal type ex) select "2" One pulse type signal Time limit after the Count Start signal ex) Key in "200" for 20 seconds (unit 0.1 sec)
P69	select FND DISPLAY type on the front panel ex) select "3" .Fastening Torque [Stop] ↔ Preset no.+Torque [Running]
* P75	select Enable on P75 (Model select) ex) select "1" for Enable of model select feature

* mark settings are always necessary.

After setting the parameter above, the FND display will show **11R 10** on the work mode. The number 05 will be decrease one by one against the screw fastening OK to "0". The number "0" will be reset to "05" on receipt of Count Start of "One pulse type signal"

The model no. can be selected

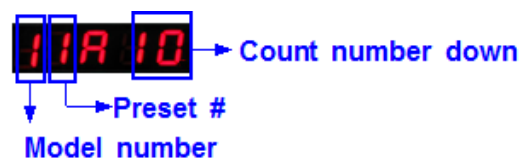

5.13.5 Operation of Model selecting

When model select feature is enabled on P75 (model select), total 20 preset numbers can be programmed to be selected in sequence on the model #.

Total 8 models can be programmed in the HDC v2.1.

The selecting models can be changed only through the remote interface I/O.

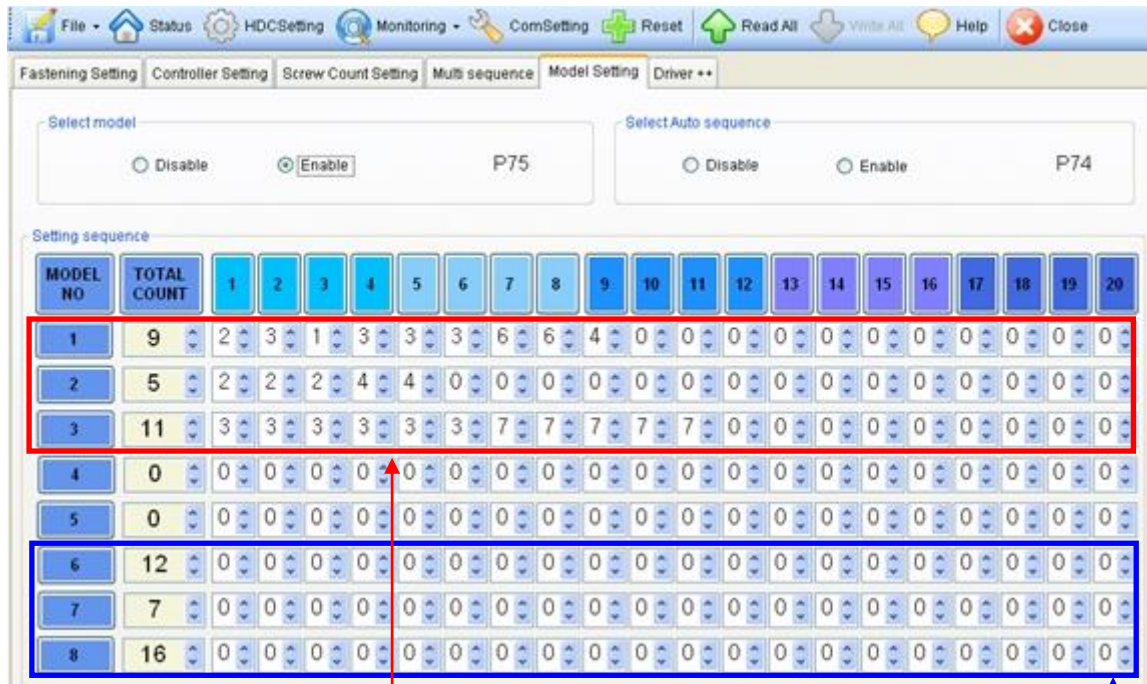

■ Auto sequence fastening

- 1) Select Enable (1) of "Select model" on P75
 - 2) Select Enable (1) of "Select Auto sequence" on P74 for auto sequence fastening
 - 3) Key in the screw numbers on total count window for Model 1 to 8
 - 4) Select preset numbers from 1st to the end for auto sequence fastening.
- The fastening number is possible up to 20 screws.

■ Non auto sequence fastening

- 1) Select Enable (1) of "Select model" on P75
 - 2) Select Disable (0) of "Select Auto sequence" on P74 for Non auto sequence fastening
 - 3) Key in the screw numbers on total count window for Model 1 to 8
 - 4) Leave "0" on every windows
- Preset # can be changed by sensor or PLC according to the selection on P64.

5.13.6 FND Display for Counter mode (select "3" on P69)

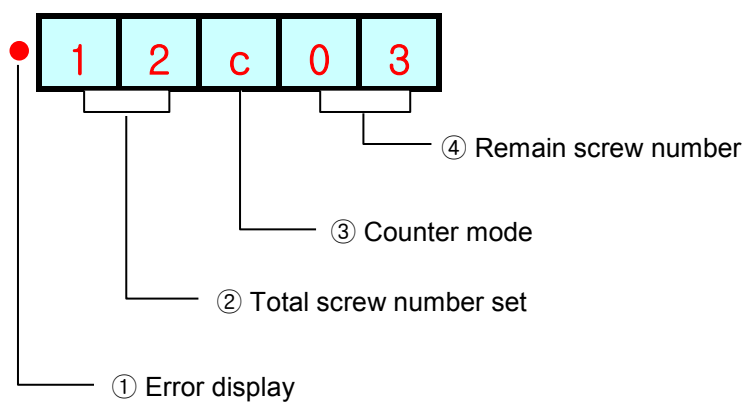

5.13.7 FND Display for Model selecting

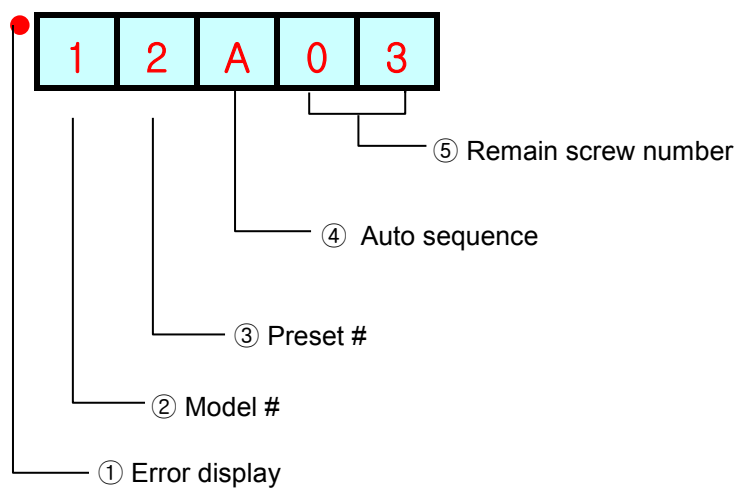

6. USB communication

HDC controller has built-in RS232-USB converter. It has the USB com port which is converted from basic RS-232C protocol communication.

To use USB com port, select "USB" on P39.

6.1 port and Cable

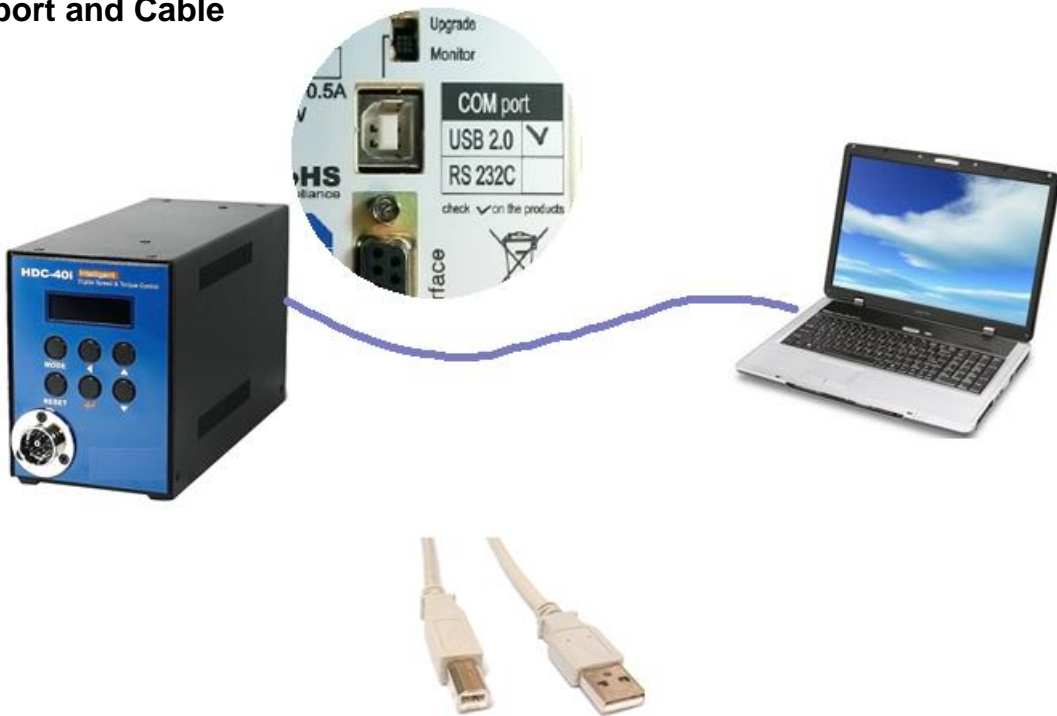

USB COM cable [A-B] type 1.8M (code [PELZ943](#))

6.2 USB Driver install

Before driver install, disconnect the cable.

Install file : HDC_40i USB driver.zip



Extract the provide file, and double click "PreInstaller.exe" for auto installation on PC.



7. RS-232C communication (Option)

The HDC controller has one RS-232C communication port.

Operator should choose one of communication port between USB or RS-232C on P59

These two communication port can not be used together at same time.

7.1 Connection

1) Select RS232 on P59 com port selecting.

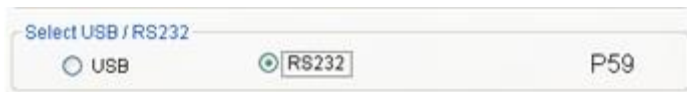

2) Cable details

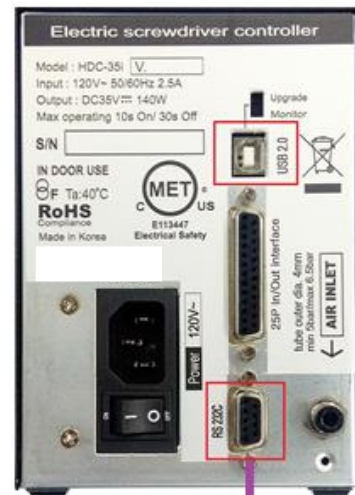

RS232C cable 2M Female-male

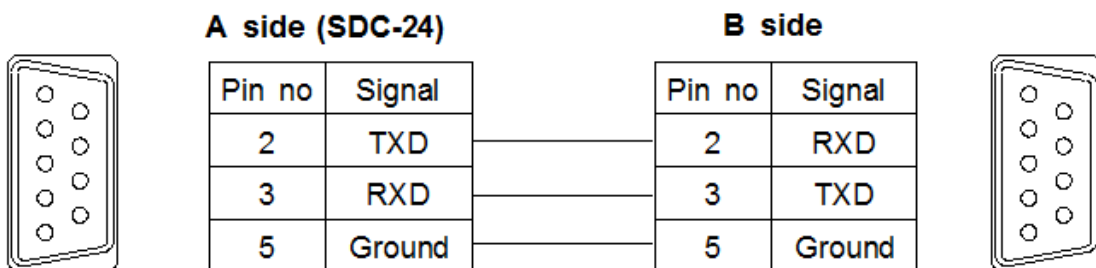

7.2 Protocol

7.2.1 Protocol frame

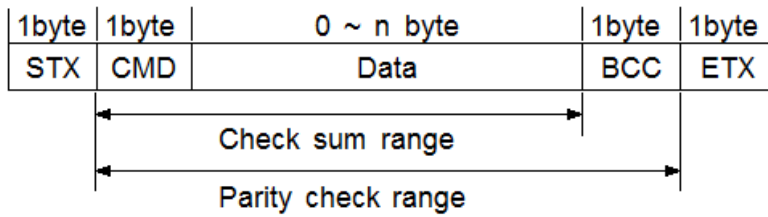

- Baud rate : 38400 BPS
- Data bit : 8bit
- Parity : None
- Stop Bits : 1

7.2.2 Communication control letter

Name	Word	Description
Packet start	STX	It means Packet start at the first of the message.
Packet finish	ETX	It means Packet end at the last of the message.
OK response	ACK	OK response on the message receipt
NOK response	NAK	NOK response on the message receipt
Packet end	ETB	It means the packet end of the first message of two blocks of long message

7.3.3 Command

The command for data request and response are same, but distinguished by the capital letter for request, the small letter for response.

no	Description	Command	Direction
1	Status request	V (capital)	PC → HDC
	Status response	v (small)	PC ← HDC
2	Parameter data request	P (capital)	PC → HDC
	Parameter data response	p (small)	PC ← HDC
3	Save the value of parameter	S (capital)	PC → ← Adm HDC
4	Monitoring data request	M (capital)	PC → HDC
	Monitoring data response	m (small)	PC ← HDC

7.2.4 Check sum(BCC)

It add all binary number within Check sum range and convert to 1 Byte of ASCII code. The "35H" is check sum result (BCC) in the example shown.

STX	CMD	Data	BCC	ETX
-----	-----	------	-----	-----

Example)

STX	V		1	.	0	0	1	BCC	ETX
-----	---	--	---	---	---	---	---	-----	-----

----- ASCII code

STX	56	20	21	2E	30	30	31	BCC	ETX
-----	----	----	----	----	----	----	----	-----	-----

----- Hexa code

```

5 6 H
2 0 H
3 1 H
2 E H
3 0 H
+ 3 0 H
-----
1 3 5 H ----- Hexa code
  ↓ ↓
33H 35H ----- Hexa value of "5" in ASCII code

```

7.2.5 Details of Command

1) Status request and response

Request

STX	V	2	BCC	ETX
-----	---	---	-----	-----

Response

STX	v	1	1	2	2	3	3	3	3	4	4	4	5	BCC	ETX
-----	---	---	---	---	---	---	---	---	---	---	---	---	---	-----	-----

1 : Target count number on P90 (Model #1) (00 - 99)

2 : Current count number (remained) (00 - 99)

3 : Current Speed set (0000 - 1800)

4 : Current Torque set / unit 0.1 (000 - 150)

5 : Fastening status

"0" : On fastening

"1" : Fastening OK

"2" : Fastening NG

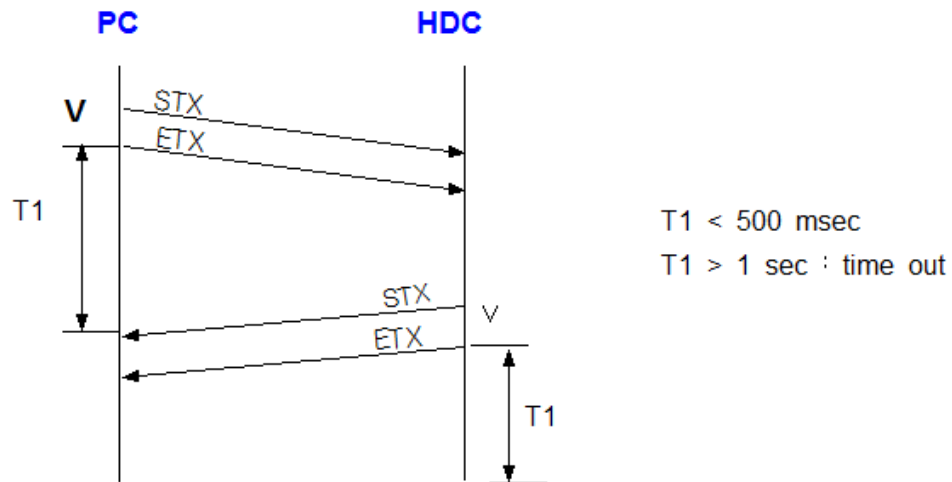

2) Parameter data request and response

Request

STX	P	1	1	1	BCC	ETX
-----	---	---	---	---	-----	-----

Response

STX	p	2	2	2	2	BCC	ETX
-----	---	---	---	---	---	-----	-----

1 : Parameter no. / ex) key in "001" which means the parameter no. P1

2 : Torque value of preset #1 in 4 digits (0000 - 9999)

Example) " 0150" for 1.5 Kgf.cm in SD120 selected

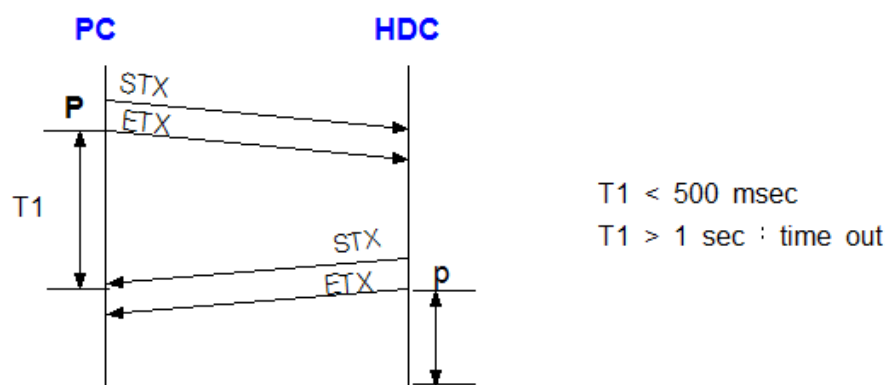

3) Save parameter data

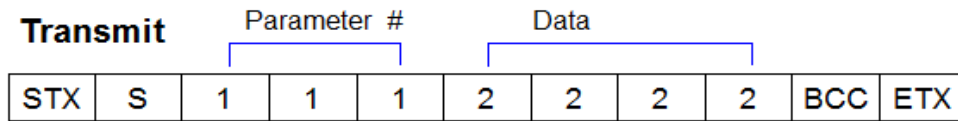

- 1 : Parameter no. / ex) key in "001" which means the parameter no. P1
 - 2 : Torque value of preset #1 in **4 digits** (0000 - 9999)
- Example) "0150" for 1.5 Kgf.cm in SD120 selected

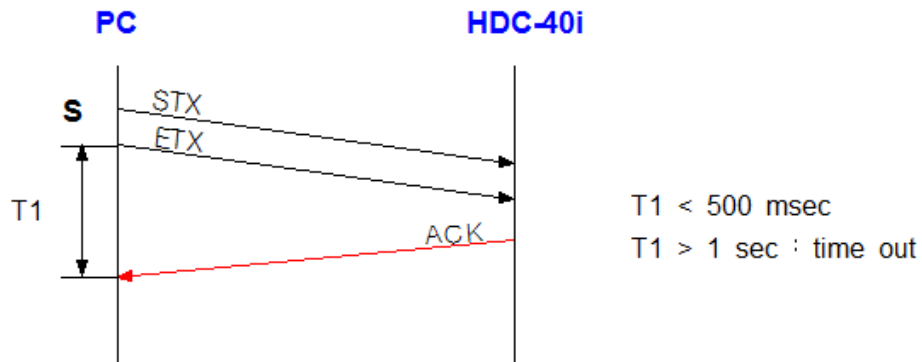

4) Request monitoring data

Request



Response

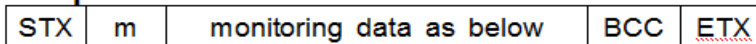

■ monitoring data

Fastening time(99999ms) & Fastening Number(1) & Torque(999)/10 &
 RPM(9999) & FastenTurn(999)/10 & Temperature(999)/10 & SystemError(999) &
 CounterValue(99) & PickCurrent(999)/10 &

*** & comes between data

6) Screwdriver information data request and response

Request

STX	D	1	1	1	BCC	ETX
-----	---	---	---	---	-----	-----

Response

STX	d	2	2	2	2	BCC	ETX
-----	---	---	---	---	---	-----	-----

1 : Parameter no. / ex) key in "001" which means driver parameter no.1

2 : Version value in 4 digits (0000 - 9999)

Example) "00009" for version 0.9

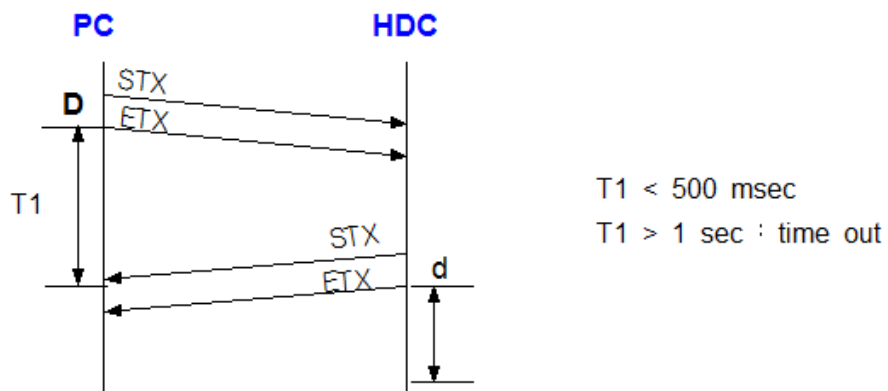

Screwdriver information data

Driver parameter	Data	Description
1	Software version	x 0.1 (unit)
2	Gear ratio	x 0.1 (unit)
3	Efficiency (%)	Standard = 100
4	Driver model	->See Model table
5	Count #1(last 2byte)	Total 8byte hexa --> 10 digits Decimal number x 10 (unit)
6	Count #2(3rd 2byte)	
7	Count #3(2rd 2byte)	
8	Count #4(1st 2byte)	
9	S/N #1(last 2byte)	Total 8byte hexa --> 10 digits Decimal number ex) 41 B1 BC F9 -->1102155001
10	S/N #2(3rd 2byte)	
11	S/N #3(2rd 2byte)	
12	S/N #4(1st 2byte)	
13	Torque compensation data	P63 on HDC
14	Calibration year	2 byte
15	Calibration month	2 byte
16	Calibration day	2 byte

Screwdriver Model table			
1	HD150	19	HD025P
2	HD220	20	HD300L
3	HD350	21	HD500L
4	HD450	22	HD1000L
5	HD120	23	HD400P
6	HD025	24	HA025
7	HD035	25	HD220J
8	HD060	26	HD081
9	HD300S	27	HD080C
10	HD015	28	HD150J
11	HA015	29	HD150 V2
12	HD012	30	HD220 V2
13	HS220	31	HD450 V2
14	HD030	32	HD150 V2J
15	HD045	33	HD220 V2J
16	HD080	34	HD450 V2J
17	HD450S	35	HD060 V2J
18	HA018	36	HD080 V2J

8. Auto fastening data output through USB port (P86)

Check mark on Enable on P86 (auto fastening data output), then every fastening data will be out at every event through RS-232 without data request command.

The output data consist of 13 fastening information as below

1	2	3	4	5	6	7	8	9	10	11	12	13	14	15	16	17
STX	data	Serial no	Fastening time	Preset #	Torque	Converted torque	RPM	Angle	Motor temp.	Error code	count no.	Motor current	Fasten Loosen	Torque up	Check Sum data	ETX
↵	m	9039001	01350	1	085	084	1700	033	0358	000	04	032	1	1	9	↳

Each data is divided by comma(,) between data.

example) ↵ **m9039001,01350,1,085,084,1700,033,0358,000,04,032,1,1,9** ↳

1. Start of Text (STX)
2. Data : m (monitoring) data
3. Serial no. : 9039001 (2009, March)
4. Fastening time : 1350 ms
5. Preset # : 1
6. Torque setting : 8.5
7. Fastening torque (converted torque) : 8.4
8. RPM setting : 1700 rpm
9. Fastening angle : 3.3 turn
10. Motor temperature : 35.8°C
11. Error code : 000 (No error, Fastening OK) if 301, error 301
12. Screw count # : 4 screws remained
13. Motor current : 3.2 Ampere
14. For / Rev : Fastening (1), Loosening (0)
15. Torque complete : Torque complete (1), No torque up (0)
16. Data check sum : See article 7.2.4
17. End of Text (EXT)

9. PC communication software, *Hi-Manager (for MS Windows)*

With free PC communication software, Hi-Manager, it is easy to set the parameters including torque, speed, fastening monitoring and quality control.

For changing parameters of controller by PC software, it require Log-in password.

For the manager Log-in password of Hi-Manager software, please contact to the distributor or service center. The password can not be open to operators without agreement of managing group. Hi-Manager without Log-in is available by request, too

9.1 Software install

- PC Operating System : MS Windows (2000, XP, Vista, WIN7, WIN8)
- Display : 1024 x 768 (Optimized)

The Hi-Manager software require MS Dot Net framework v 2.0 or higher on your OS before install.

Window 2000 and XP can be updated with Dot Net framework on the download center of Microsoft web site. (www.microsoft.com).

[Microsoft .NET Framework ver 4.0](#)

For installation of Hi-Manager, just copy the file (Hi-Manager.exe) on your PC, and double click for open.

9.2 How to use

- Install the provided USB driver (HDC USB driver) on your PC
- Connect the HDC controller to PC, and Power on.
- Check COM port no. for HDC USB port on your PC.
example) **CP210x USB to UART Bridge Controller** (COM4)
- Open the *Hi-Manager* software
- Select the Comport no and click OK
- Click " READ ALL " menu for read all parameters from the connected HDC controller.
- For changing parameter, it require Manager Log-in password.

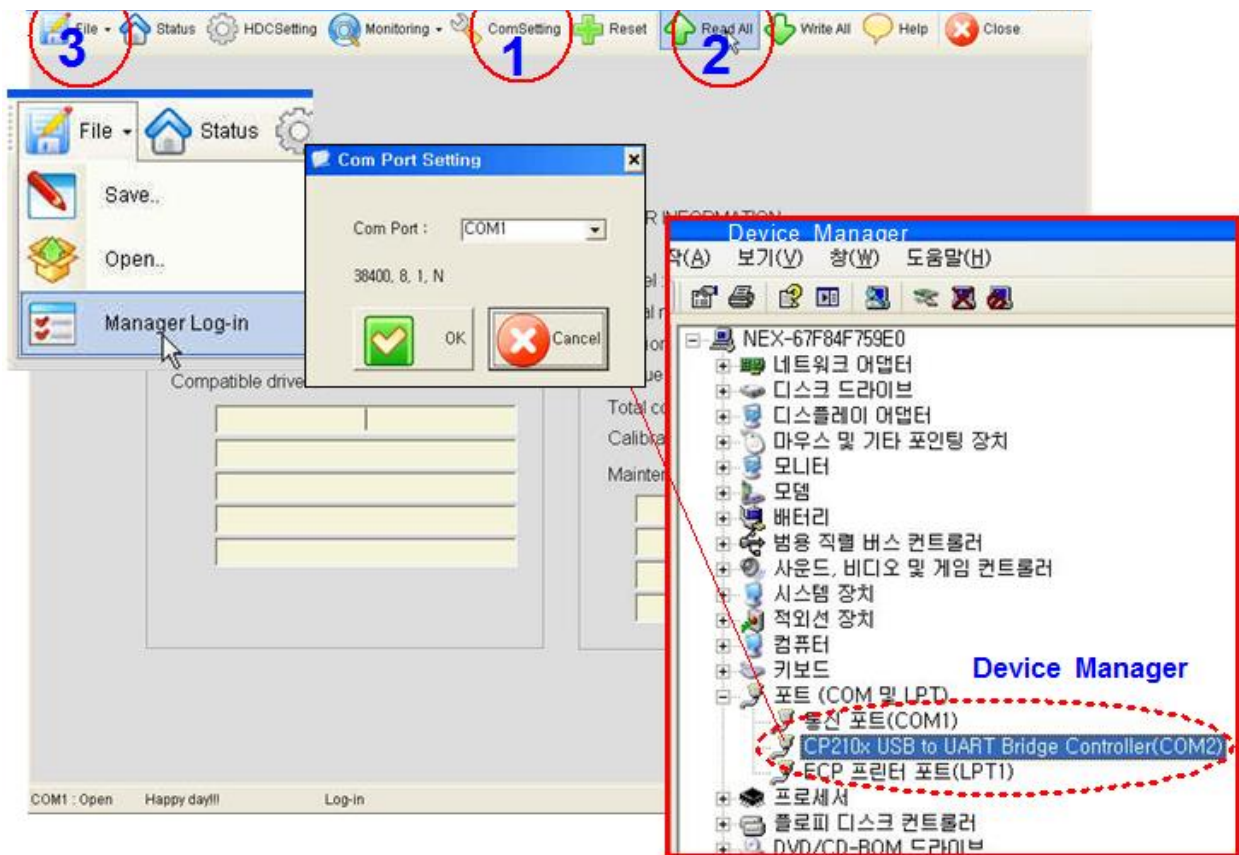

If you can find Controller and Driver Information on the opening page as below, the communication is successful.

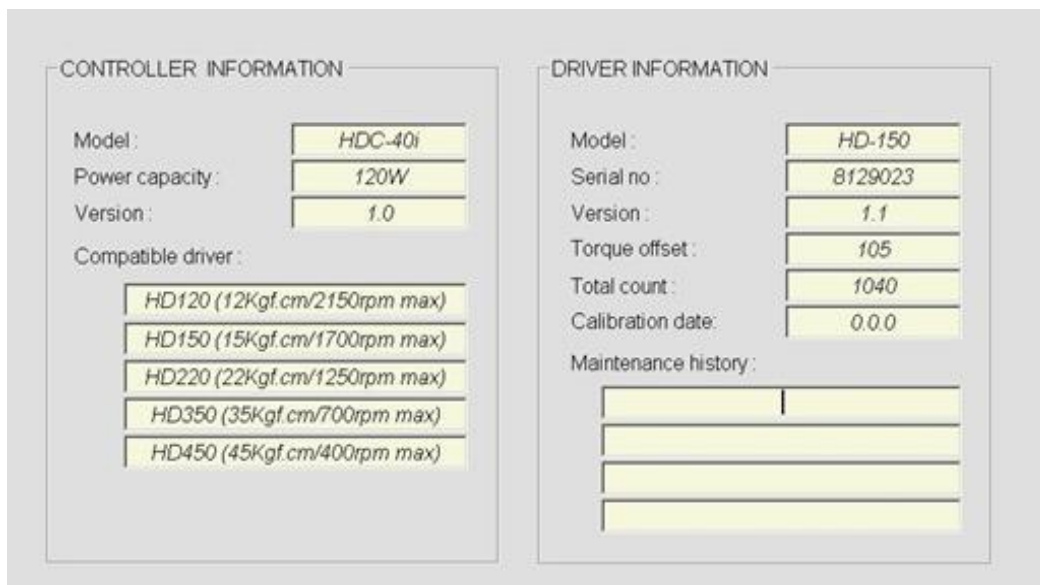

9.3 Parameter setting on *Hi-Manager*

1) Fastening Setting (HDC Setting -->)

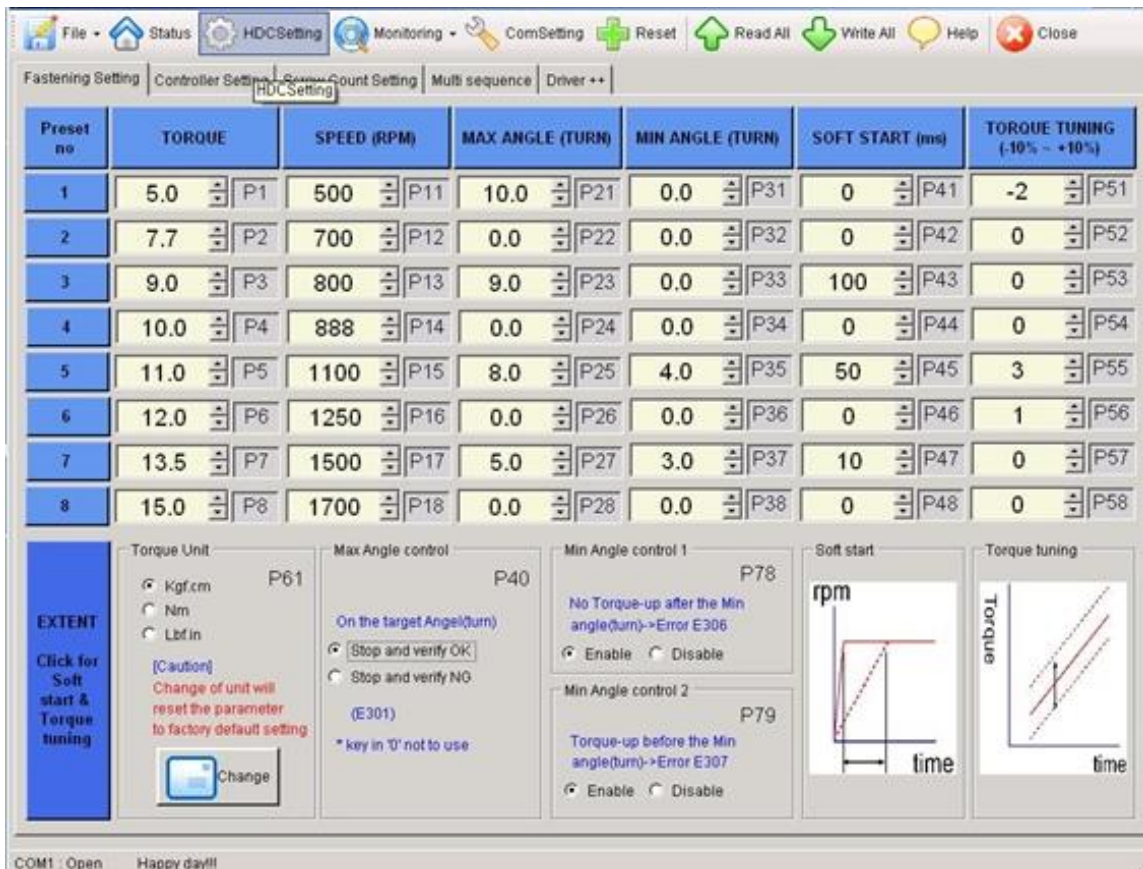

- Select the torque unit before setting other parameters. Otherwise all parameters changed to the factory setting after change of torque unit.
- Change or select parameters, and Click "WRITE ALL" menu to write new settings on the connected HDC controller.
- To allow parameter change, be sure that it require **Manager Log-in** on File menu. Ask to the distributor for the **Log-in password**.
- Monitoring is possible without Manager Log-in.

2) Controller Setting (HDC Setting -->)

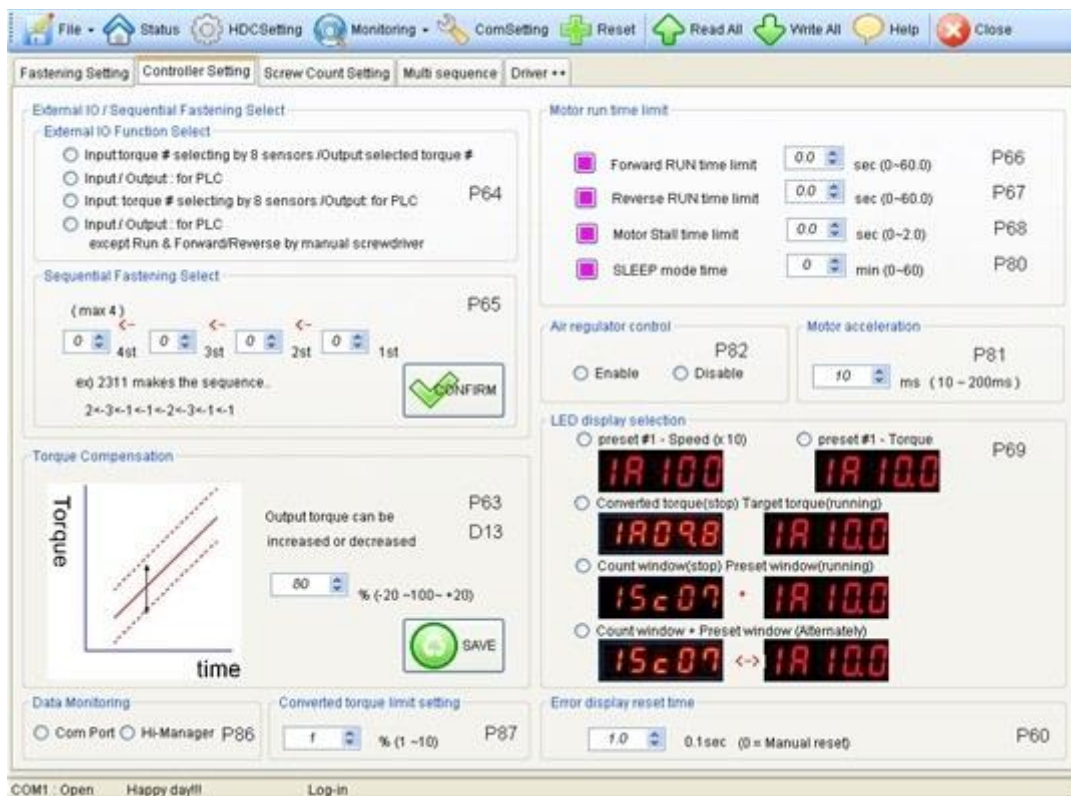

** Refer to 5.6 Parameter details

3) Screw Count Setting (HDC Setting -->)

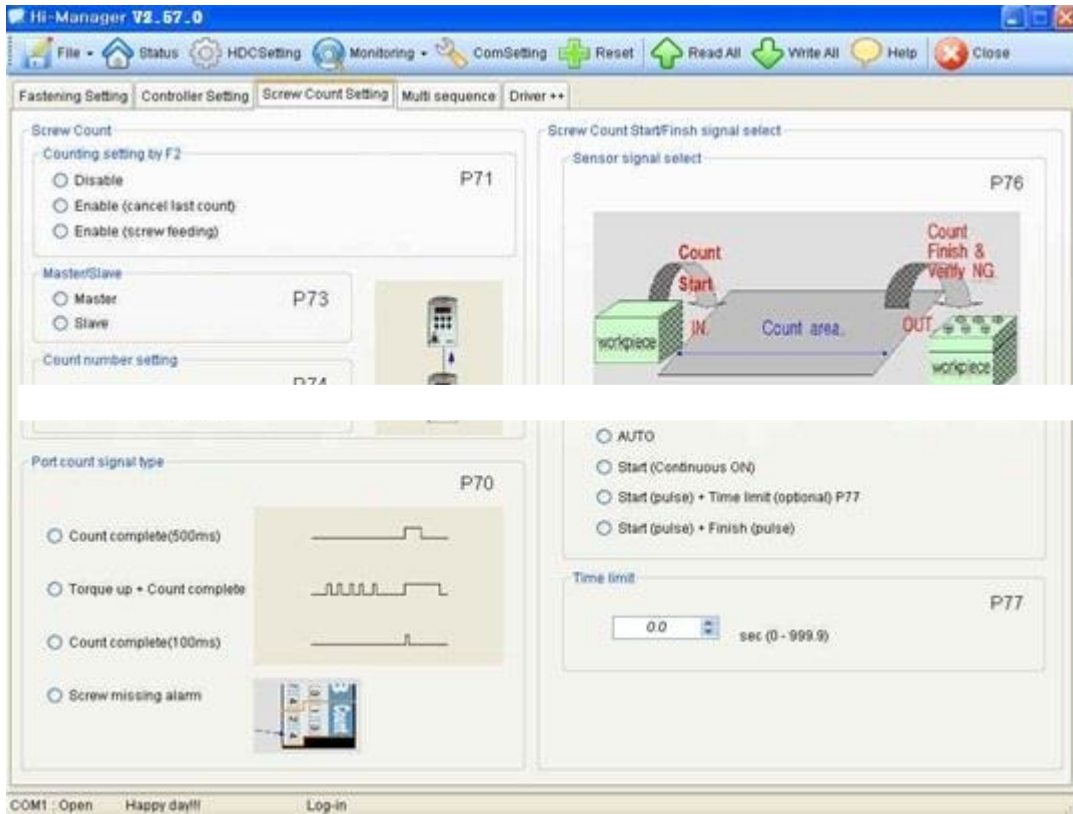

4) Multi Sequence Setting (HDC Setting -->)

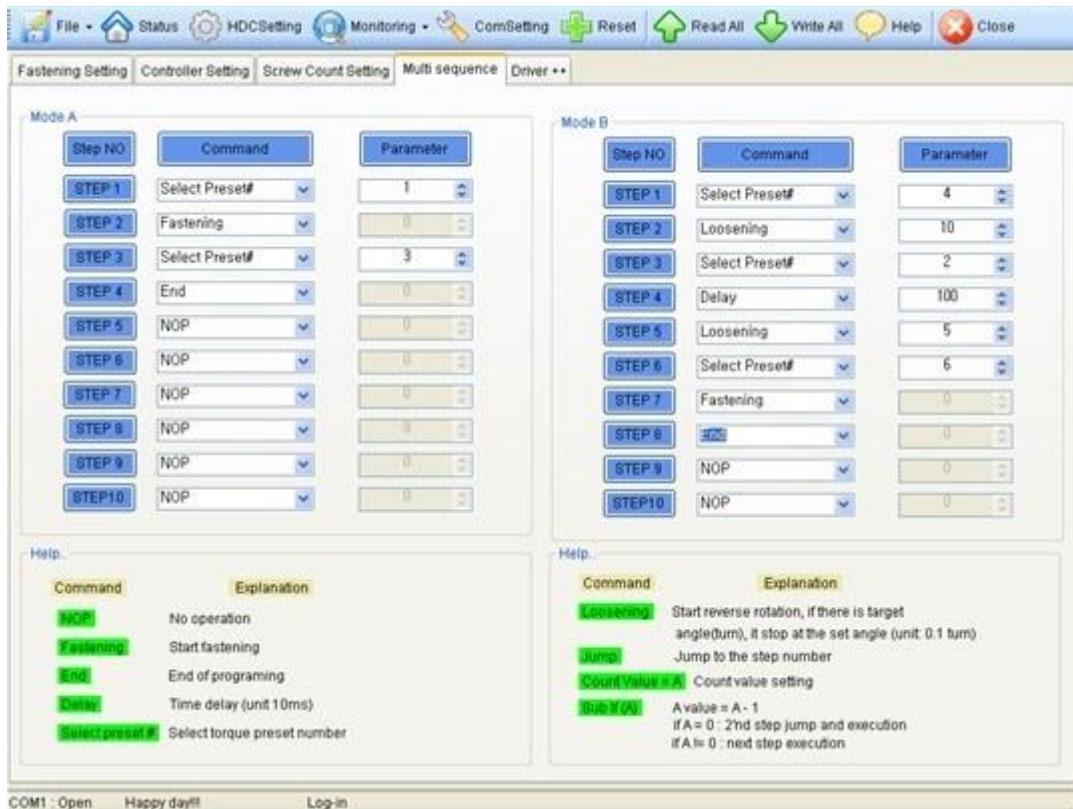

** Mode A, B comes after preset # 8 with displaying of mA, mB.

※ Explanation details of JUMP, COUNT VALUE=A, SUB IF(A) command

■ Example multi sequence program

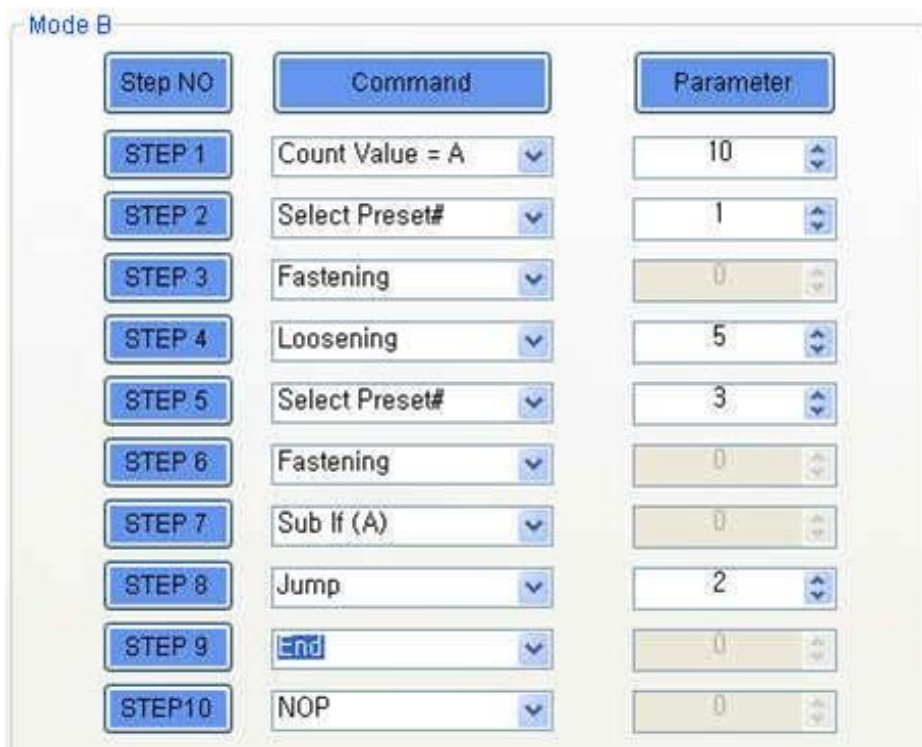

The above multi sequence shows 10 times repeat of steps from 2 to step 7, and finish cycle completely.

- Count value = A

Count number of step selected or operated

- Sub if (A)

If the counted number A (on step 1), is not 10, go to the next step (8)

If the counted number A (on step 1), go the 2nd next step (9).

- Jump

Move to the setting step (2)

5) Driver ++ setting

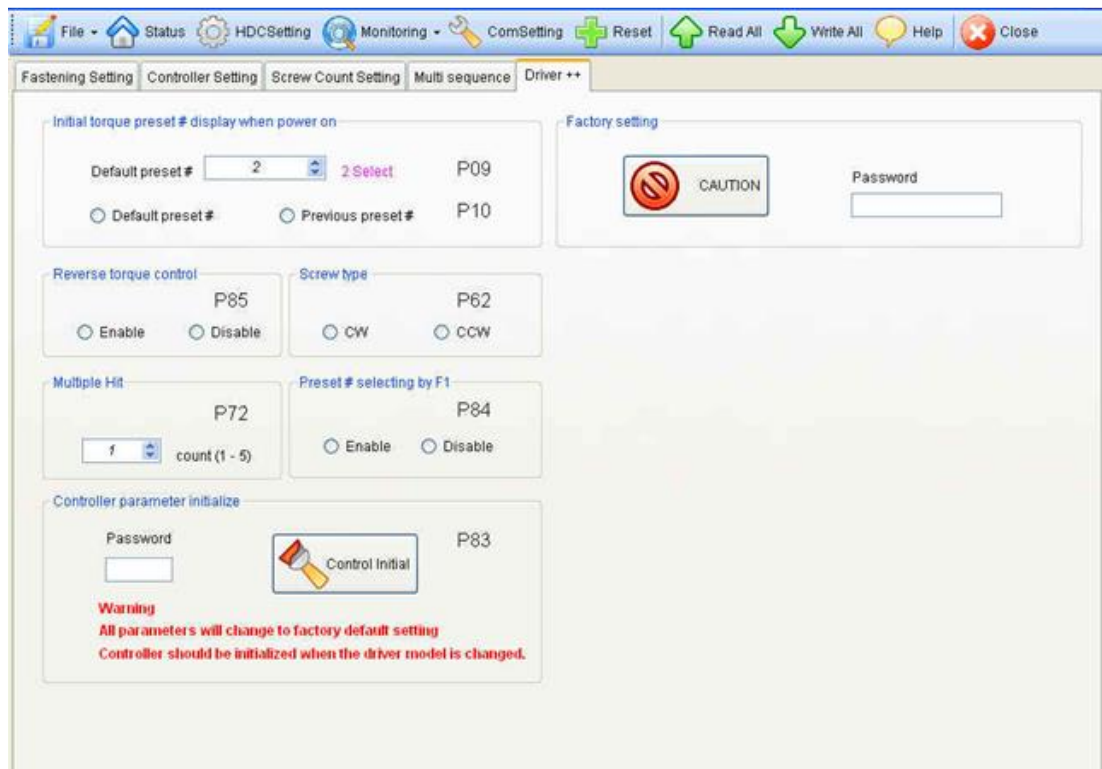

** refer to 5.6 Details of each parameter numbers

6) Model selecting

Fastening Setting Controller Setting Screw Count Setting Multi sequence **Model Setting** Driver **

Select model: Disable Enable P75

Select Auto sequence: Disable Enable P74

Setting sequence

MODEL NO	TOTAL COUNT	1	2	3	4	5	6	7	8	9	10	11	12	13	14	15	16	17	18	19	20
1	9	2	3	1	3	3	3	6	6	4	0	0	0	0	0	0	0	0	0	0	0
2	5	2	2	2	4	4	0	0	0	0	0	0	0	0	0	0	0	0	0	0	0
3	11	3	3	3	3	3	7	7	7	7	7	0	0	0	0	0	0	0	0	0	0
4	0	0	0	0	0	0	0	0	0	0	0	0	0	0	0	0	0	0	0	0	0
5	0	0	0	0	0	0	0	0	0	0	0	0	0	0	0	0	0	0	0	0	0
6	12	0	0	0	0	0	0	0	0	0	0	0	0	0	0	0	0	0	0	0	0
7	7	0	0	0	0	0	0	0	0	0	0	0	0	0	0	0	0	0	0	0	0
8	16	0	0	0	0	0	0	0	0	0	0	0	0	0	0	0	0	0	0	0	0

Total 20 screws can be fastened by the sequence on each 8 models.

For sequence fastening, select Enable on P74 and P75.

9.4 Monitoring on *Hi-Manager*

1) Screw Count monitoring (Monitoring -->)



Total 9 screw count program can be saved on the Hi-Manager.

Choose one of 9 program, and Select one program

2) Real Time Data monitoring (Monitoring -->)

Number	Time	F_Time	F_No	T/Tq	C/Tq	Speed	Angle	Temp	Error	Count	Current	FL	Complete
1	2009-07-24 오전	590	1	0.80	0.79	1000	8.8	28.9	0	4	0.6	F	Complete
2	2009-07-24 오전	540	1	0.80	0.80	1000	8	28.9	0	3	0.5	F	Complete
3	2009-07-24 오전	600	1	0.80	0.79	1000	9.1	28.9	0	2	0.5	F	Complete
4	2009-07-24 오전	570	2	0.90	0.90	650	5.5	28.9	0	1	0.4	F	Complete
5	2009-07-24 오전	440	2	0.90	0.89	650	4.1	28.9	0	5	0.3	F	Complete
6	2009-07-24 오전	500	3	1.00	0.99	820	6	28.9	0	4	0.4	F	Complete
7	2009-07-24 오전	450	3	1.00	0.99	820	5.4	28.9	0	3	0.4	F	Complete
8	2009-07-24 오전	430	3	1.00	0.99	820	5.2	28.9	0	2	0.3	F	Complete
9	2009-07-24 오전	290	3	1.00	0.99	820	3.3	28.9	0	1	0.2	F	Complete
10	2009-07-24 오전	650	5	1.20	1.20	500	4.9	28.9	0	5	0.4	F	Complete
11	2009-07-24 오전	440	5	1.20	1.20	500	3.1	28.9	0	4	0.4	F	Complete
12	2009-07-24 오전	540	6	1.30	1.30	1000	8	28.9	0	3	0.7	F	Complete
13	2009-07-24 오전	440	6	1.30	1.30	1000	6.3	28.9	0	2	0.6	F	Complete
14	2009-07-24 오전	360	6	1.30	1.30	1000	5.1	28.9	0	1	0.4	F	Complete
15	2009-07-24 오전	580	3	1.00	0.99	820	7.2	28.9	0	5	0.4	F	Complete
16	2009-07-24 오전	520	3	1.00	0.99	820	6.4	28.9	0	4	0.4	F	Complete
19	2009-07-24 오전	550	5	1.20	1.20	500	4	28.9	0	1	0.4	F	Complete
20	2009-07-24 오전	520	5	1.20	1.20	500	3.7	29.9	0	5	0.4	F	Complete
21	2009-07-24 오전	530	1	0.80	0.79	1000	8	29.9	0	4	0.5	F	Complete
22	2009-07-24 오전	540	1	0.80	0.79	1000	8	29.9	0	3	0.4	F	Complete
23	2009-07-24 오전	440	1	0.80	0.79	1000	6.5	29.9	0	2	0.4	F	Complete
24	2009-07-24 오전	580	3	1.00	1.00	820	7.2	29.9	0	1	0.4	F	Complete
25	2009-07-24 오전	500	3	1.00	1.00	820	6	29.9	0	5	0.4	F	Complete

Data are saved on PC with csv format

10. Trouble shooting (Error code details on page 36,37)

Error code	Trouble shooting
100	<p>Failure of air pressure The output air pressure is out of $\pm 5\%$ of tolerance against the target by no input air pressure or leakage in air line. The error is reset by pressing RESET button.</p> <p>1) If there is no input air pressure, there will be a noisy sound of regulator in the controller. Turn off the power and check the air inlet outside</p> <p>2) If there is leakage of pressed air from the regulator to driver, check the air lines through the connector, cable and actuator clutch. The output pressed air is closed on Jog and Parameter mode</p>
101	<p>Hall sensor error The controller failed to read the hall sensor signal from the driver.</p> <p>1) Check the cable quality and connectors 2) wiring inside of the driver</p>
110	<p>Over current on AMP board circuit There is current over the limit in the system.</p> <p>1) Check any mechanical load failure 2) Check the motor quality.</p>
112	<p>Over load The current is over 5A for 1 second or more. The application is over the driver capacity.</p>
113	<p>Overheat of motor The temperature of the motor is over 80°C. The application is over the motor capacity. The intermittent operation as like 1sec ON - 3sec Off is one of the solution of the overheat</p>
117	<p>Over Run time limit The driver stop automatically at the set run time limit. The initial value is 10 seconds. It reset automatically.</p>

Error code	Trouble shooting
200	<p>Driver data error</p> <p>The driver data on EEP-ROM of the driver is not verified.</p> <p>Keep the controller power off when the driver connect to the controller.</p> <p>The ROM data might be lost.</p>
202	<p>Initial communication failure</p> <p>The controller failed to communicate with the connected driver when it turned on. Retry the power on after off</p>
204	<p>Communication failure over 1 sec.</p> <p>Check the connection of cable between driver and controller</p>
303	<p>Over time of Motor Lock</p> <p>When the driver loosen a screw, the motor can be lock by the higher torque tightened screw. In order to prevent the motor overheat, it stop immediately after 1 second from the motor lock.</p>

HDC Firmware / Hi-Manager Upgrade History by version

NO	Date	Firmware Version	Upgrade history	Hi-Manager Software	Controller Hardware (Back of Unit)
27	2010.11.01	V2.14	P65 beep sound on/off added	V1.34	2.1
28	2010.12.08	V2.21	1) model added : HD-300L,500L,1000L 2) unit added : ozf-in (HDC-30i only)	v1.36	2.1
29	2011.01.28	V2.3	P73 added : number of Preset # for selection by F1/F2 on screwdriver (available when "3" selected on P71) F1 works for move up, F2 works for move down of preset # or model no. (Doga requested)	v1.37	2.1
30	2011.03.11	V2.4	1) bug solved : During sequence fastening by Model selecting, the last count cancel by F2 button couldn't recall the last preset #. 2) modification : Delet the converted torque display on realtime monitoring when stopped by angle(turn) --> request by Doga	v1.37	2.1
31	2011.04.06	V2.42	1) Every event on Multi-sequence will be displayed on realtime monitoring 2) bug solved : torque setting in ozf.in on Hi-manager	v1.38	2.1
32	2011.04.14	V2.43	P63 : additional feature / calibration value (efficiency) can be wote on P63. This value is saved on rom of screwdriver	v1.38	2.1
33	2011.05.27	V2.44.1	Model added - HD025P(SamsungTSOE request 0.6~2.5Kgf.cm / harmoinized version between firmware and Hi-Manager	v2.44.1	2.1
34	2011.09.19	V2.45.0	Model added - HD400P / replacing HD450P by max torque difference	v2.45.0	2.1
35	2011.10.21	V2.46.0	1) Model added-HA025(for Samsung mobile new bit cushion and calibration only) 2) Gear efficiency maximum 150% from 120% 3) Initialized for HDA025 as a standard driver	v2.46.0	2.1
36	2011.10.24	V2.46.1	No use	v2.46.0	2.1
37	2011.10.24	V2.46.2	The factory setting of P64 (I/O) is changed to "1" (IN/OUT for PLC) from "0" for the driver model HD025, HDA025 is connected.	v2.46.0	2.1
38	2011.11.02	V2.47	P29 added. Cycle Reset by the Reset button on the front panel Enable or Disable	v2.47.0	2.1
39	2011.12.22	V2.48	1) P64 I/O select - added "4. Connect to Socket Tray. 2) P78 modified to 1)No torque up before Min. 2) No torque up after Min. 3) No torque up in all cycle	v2.48.0	2.1
40	2012.03.30	V2.49	1) Model added - HD220J for Jabil project torque range : 7 ~ 26 Kgf.cm 2) Parameter added- P30 : Reverse Enable/Disable	v2.48.0	2.1
41	2012.07.18	V2.50	Model added - HD081 for Samsung SESK. The torque range is same as HD080. But it share the same design with HD150	v2.48.0	2.1
42	2012.03.30	V2.51	German language added	v2.50.0	2.1
43	2013.01.15	V2.52	Model added - HD080C, HD150J for Jabil, Malaysia 080C : 2.2 ~ 7.5kgfcm / 150J : 4.0 ~ 15.0kgfcm speed : 200 ~ 1000rpm	v2.52.2	2.1
44	2013.01.23	V2.53	Model added - HD150 V2, HD220 V2 for Jabil, Malaysia. V2 version solved that the first torque was much higher than others.	v2.53.0	2.1
45	2013.04.02	V2.54.1	Max turn value was excluded in range -> changed it to be included in OK range.	v2.53.0	2.1
46	2013.05.15	V2.54.4	Fastening data output / model no. output instead of preset # (requested by Torq-on for Denso monitoring program)	v2.53.0	2.1
47	2013.10.08	V2.55.1	New torque formula for V2J version in Jabil. EZ-Torq II with Sehan RDA, Asian filter setting	v2.53.0	2.1
48	2013.11.21	2.55.2	Test version for Jabil - HD060V2J and HD080V2J added	v2.53.0	2.1
49	2013.12.09	V2.55.3	model added : HD30N, HD45N, HD100N	v2.53.0	2.1
50	2013.12.19	V2.56.0	by Jabil request (Only for V2J version) - V2 has same torque formula with V1 in FW - New torque spec of HD060V2J: 1.9~4.2 lbf.in	v2.53.0	2.1
51	2014.02.07	V2.56.2	- P88 : Soft/Hard joint select feature removed. - P88 : Driver Lock (I/O) feature in direction 0 : Both direction 1 : Reverse direction Lock only 2 : Forward direction Lock only	v2.56.2	2.1
52	2014.05.23	V2.57	SCAN TIME change to 0.5s from 1.0s in programing for short torque up signal time of HDC-35i	v2.56.2	2.1
53	2014.05.30	V2.58	Bit socket tray - selectable socket no. on P50	v2.57	2.1
54	2014.07.07	V2.58.2	- Torque range modification of HD081 2.5 - 8.0Kgf.cm --> 2.5 - 8.3Kgf.cm by request of Doga	v2.57.2	2.1
55	2014.09.03	V2.58.5	LG- Special Request	v2.57.2E	2.1
56	2014.10.13	V2.60.0b	Automatic parmater reset to factory setting feature deleted when the driver model is replaced. Manual parameter reset is required when the driver is replaced with the different model of driver.	v2.57.2E	2.1
57	2014.11.13	v2.60.2	1) parmater P98 added : Start signal OFF delay time Special Request. 2) Customer lost the fastening OK output when operator release start lever just before torque up, but clutch was activated by inertia. range : 0 - 1,000 mS factory setting : 10mS. 3) Motor immediate stop by breaking when start signal OFF.	v2.57.5E	2.1
58	2015.04.06	v2.61.0	1) F/R status OUT signal change (Forward :1, Reverse:0 --> Forward:0, Reverse:1). 2) UP button is available to select Model no. when P75 is enabled. 3) Operation change / Unless other model no. was not selected, the latest loaded model no. is continuously effective even if it's program was changed. 4) The lowest torque setting range is changed from 7 to 5 Kgf.cm for HD220 & HD220P.	v2.57.6E	2.2
	2015.04.06	v2.61.1	Fastening Min. Max angle error does not provide angle data output	v2.57.6E	2.2
59	2015.05.14	v2.61.2	solved Socket tray bug.	v2.57.6E	2.2
60	2015-05-22	v2.61.3	Converted torque(E308) error bug fix.	v2.57.6E	2.2