



Harmony[®] XB4 metal

Control and signaling units



Harmony

Discover Harmony

Advanced operator interface and industrial relays

Harmony operator interface and industrial relays enhance operational efficiency and equipment availability across industrial and building applications. **Harmony** includes intelligent connected products and edge terminals that visualize, gather and process data, enabling informed operator decisions.

Explore our offer

- [Harmony Push Buttons and Switches](#)
- [Harmony HMI Operator Terminals, IPC and EdgeBox](#)
- [Harmony Signaling Devices](#)
- [Harmony Electrical Relays](#)
- [Harmony Safety](#)

Life Is On

Schneider
Electric

Quick access to product information

Get technical information about your product

References

Modicon TM3
I/O expansion modules for Modicon controllers
Analog I/O modules

References	Modicon TM3 analog input modules	Number and type of channels	Input range	Output range	Resolution	Aperture time (microsec)	Reference	Weight (kg)
TM3AI2H	2 voltage/current inputs	2	-15...+10 VDC	16 000 of	12 bits	0.5 ms	TM3AI2H	0.110
			-15...+10 VDC 0...20 mA A.C. 20/5A	16 000 of	12 bits	0.5 ms	TM3AI2H	0.110
TM3AI2H	4 voltage/current inputs	4	-15...+10 VDC	12 000 of	8 bits	0.5 ms	TM3AI2H	0.100
			-15...+10 VDC 0...20 mA A.C. 20/5A	12 000 of	8 bits	0.5 ms	TM3AI2H	0.100
TM3AI2H	4 voltage/current or temperature inputs (I, R, P, S, T, A, E, C)	4	-15...+10 VDC	16 000 of	12 bits	0.5 ms	TM3AI2H	0.110
			-15...+10 VDC 0...20 mA A.C. 20/5A	16 000 of	12 bits	0.5 ms	TM3AI2H	0.110
TM3AI2H	4 differential temperature inputs (I, R, P, S, T, A, E, C)	4	-15...+10 VDC	16 000 of	12 bits	0.5 ms	TM3AI2H	0.110
			-15...+10 VDC 0...20 mA A.C. 20/5A	16 000 of	12 bits	0.5 ms	TM3AI2H	0.110

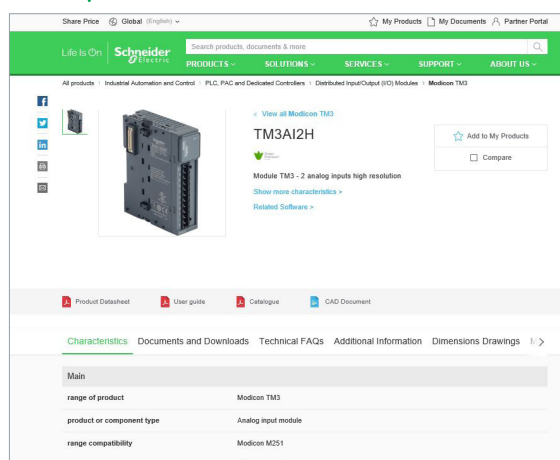

Each commercial reference presented in a catalog contains a hyperlink. Click on it to obtain the technical information of the product:

- Characteristics, Dimensions and drawings, Mounting and clearance, Connections and schemas, Performance curves
- Product image, Instruction sheet, User guide, Product certifications, End of life manual

Find your catalog

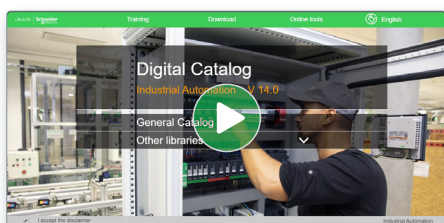

- > With just 3 clicks, you can access the Industrial Automation and Control catalogs, in both English and French
- > Consult digital automation catalogs at [Digi-Cat Online](#)

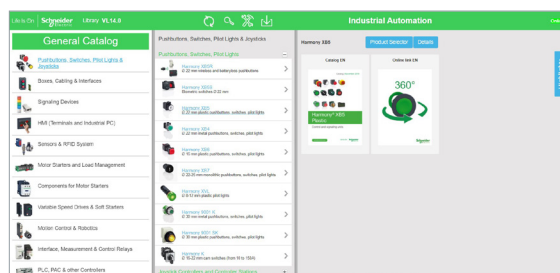

- Up-to-date catalogs
- Embedded product selectors, 360° pictures
- Optimized search by commercial references

Select your training



- > Find the right [Training](#) for your needs on our Global website
- > Locate the training center with the selector tool, using this [link](#)

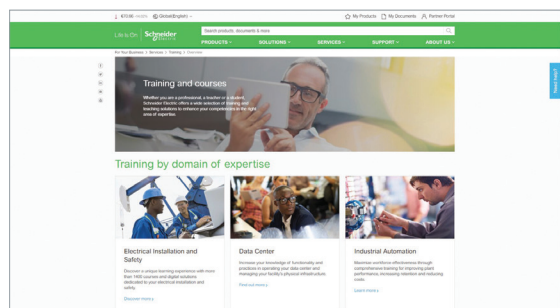

General contents

Harmony® XB4 metal

■ General presentation.....	page 2
■ Presentation	
□ Presentation, installation, and environment.....	page 10
■ Description	
□ Complete units, XB4B and XB4F.....	page 12
□ Sub-assemblies, ZB4B and ZB4F.....	page 16
■ Installation	
□ Contact mounting - Contact sequence.....	page 24
■ References	
□ Spring return pushbuttons, unmarked and with marking.....	page 26
□ Illuminated pushbuttons, spring return	
- With integral LED and BA 9s base fitting.....	page 30
□ Flush mounted spring return pushbuttons, unmarked and with marking.....	page 34
□ Flush mounted illuminated pushbuttons, spring return	
- With integral LED.....	page 37
□ Multiple-headed pushbuttons, spring return.....	page 40
□ Mushroom head pushbuttons, spring return and latching.....	page 42
□ Emergency stop and Emergency switching off functions.....	page 44
□ Illuminated rings and circular yellow legends for Emergency stop.....	page 46
□ Illuminated Emergency switching off function and circular yellow legends.....	page 47
□ Large head pushbuttons with integrated bellows.....	page 48
□ Pushbuttons and illuminated pushbuttons, push-push.....	page 50
□ Flush mounted pushbuttons with push-push, illuminated and non-illuminated.....	page 52
□ Selector switches	
- With standard handle and long handle.....	page 54
- Key switches, toggle switches, and with knurled knob.....	page 56
- Illuminated, with standard handle and integral LED.....	page 58
□ Flush mounted selector switches	
- With standard handle and long handle.....	page 60
- Key switches, and with knurled knob.....	page 62
- Illuminated, with standard handle and integral LED.....	page 64
□ Pilot lights	
- With integral LED and BA 9s base fitting.....	page 66
- Push-to-test pilot light.....	page 69
□ Flush mounted pilot light with integral LED.....	page 70
□ Specific functions	
- Manual overload reset pushbuttons, potentiometers.....	page 72
- Timers, hour counters, annunciators, USB/RJ45 ports, and fuse carrier.....	page 73
- Joystick controllers and wobblesticks.....	page 74
□ Body/contact assemblies and light blocks.....	page 76
□ Accessories	
- For heads.....	page 90
- Legends, legend holders, legends panel, and illuminated rings.....	page 94
- For pushbuttons.....	page 106
Selection guide.....	page 112
■ Product reference index.....	page 114

Control and signaling units

Pushbuttons, switches, and pilot lights



Life Is On

Schneider
Electric

Control and signaling units

Harmony XB4 metal

Pushbuttons, switches, and pilot lights

The Harmony XB4 range of metal pushbuttons, switches, and pilot lights combines simplicity of installation, flexibility, and robustness to meet the majority of industrial applications. It delivers one of the most comprehensive product ranges available on the market and meets the robustness and performance requirements for the majority of industrial applications.



Complete unit for repetitive orders XB4BA31

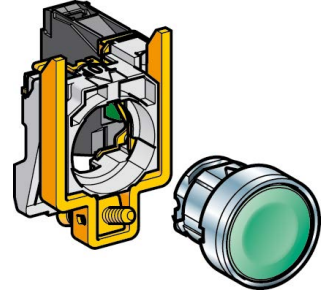

Sub-assembly (for additional flexibility) ZB4BZ101 + ZB4BA3

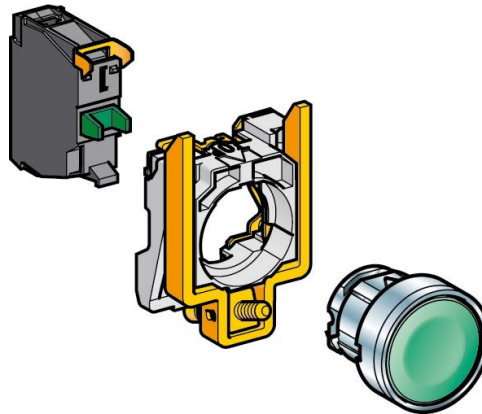

Basic elements (for optimum flexibility) ZBE101 + ZB4BZ009 + ZB4BA3

A single provider

Our team of experts understands the needs of our customers in terms of their processes and applications. The Harmony ranges are available globally wherever you need them.

The confidence of a market leader

- > More than 50 years' experience designing switches, pushbuttons, and pilot lights
- > A global network of partners and distributors you know and trust
- > Worldwide product availability with over 17,000 points of sale in more than 100 countries



A global network of partners you can rely on to support customized end-to-end solutions

Control and signaling units

Harmony XB4 metal

Pushbuttons, switches, and pilot lights

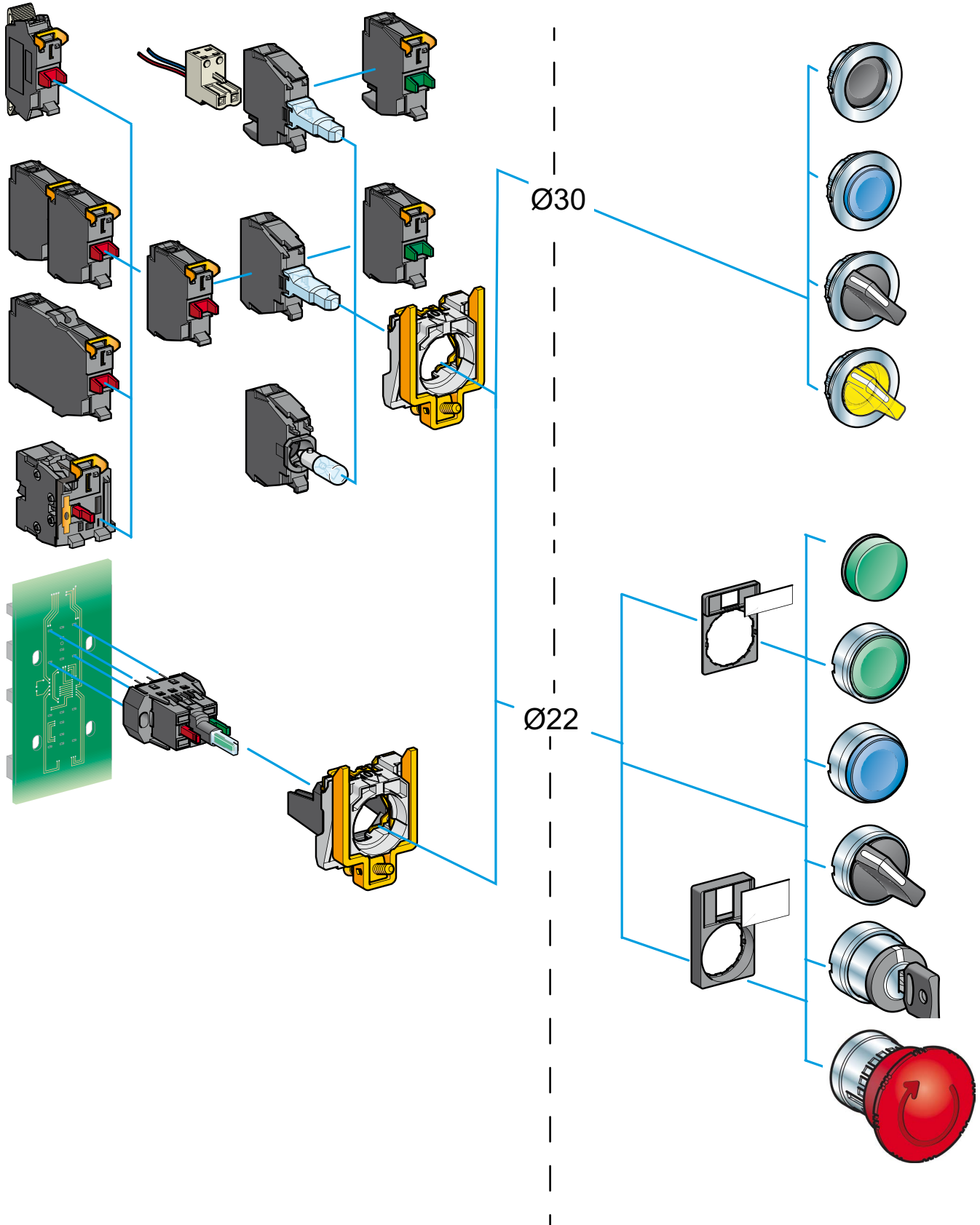

Modern design

Harmony delivers an innovative and ergonomic design that allows easy operation and improves the look and feel of your control panels and machines.

Improved reliability of panels, machines, and processes

- > The flush-mounting solution addresses the market demands for ergonomic design and aesthetics
- Built-in flush pushbuttons
- Flush mounting kit accessories
- > Pushbuttons and switches with a vibrant color pallet

A touch of style for your electrical panels

- > Innovative design without compromise on cost
- > Better perceived quality of your machines and panels
- > A clearer view of control features

> Define your own style with powerful customization options

- > Markings on pushbutton, illuminated pushbuttons, and pilot lights caps
- > Markings on the bezel for all built-in flush products
- > Markings on accessories, like legend plates and legend panels

360° view
Click on the image for 3D view



Customized products



Operational efficiency

The Harmony XB4 range offers innovative features for ease-of-use to make an operator's work simpler and more efficient.



Emergency stop pushbutton with illuminated rings

Improved operator efficiency

- > Illuminated Emergency stop pushbutton solutions that help you quickly find the E-stop button responsible for the production downtime
- > Robust illuminated and non-illuminated buzzers providing water resistance up to IP66, IP67, IP69, and IP69K
- > High brightness and full-surface illumination of pushbuttons and selector switches
- > Dedicated offer for explosive atmospheres

Affordable

Harmony delivers simplicity and efficiency while helping to keep your costs down.

Faster, simpler installation and maintenance

- > Self-holding function of actuator when mounting
- > Timer for safe and simple adjustment of your machine's time settings
- > USB and RJ45 ports for a simple, effective way to connect a PC or USB
- > 3 phase pilot lights mounted in a single 30 mm (1.181 in.) diameter hole

Affordable range

Click to open video (33 sec)

Mounting options for easy
access to functions on the
front panel



USB port



RJ45 port



Timer



3-phase indicator



Complete potentiometer



Fuse carrier



Buzzer



Legend panel

Legend panels that help simplify installation

- > Hole positions are clearly identified and aligned on the legend panels
- > Just stick the legend panel on your operator interface surface and punch the hole where indicated
- > Save up to 75% of installation time compared with conventional hole alignment methods

Simple selection

Harmony XB4 delivers a comprehensive range of products that enable simple selection to help minimize your costs right from the beginning.

Web digital selector
Click to open the selector

Digital tools help you select the right product and customize it to meet your needs

- > Digi-Cat, for easy, up-to-date access to the PDF catalogs
- > Web digital selector to help you find the right reference for your application and customize your product.

Digi-Cat
Click to download Digi-Cat

Easy to convert from standard to flush mounted pushbuttons

- > Harmony XB4 pushbuttons offer the flexibility to convert from standard to flush mounting versions by simply changing a single letter in the product reference.

Example:

ZB4BA3



ZB4FA3

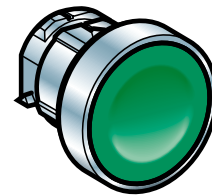

Standard
mounting

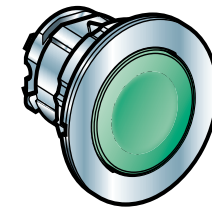

Flush
mounting

The secret of robustness
Click to open video (46 sec)

IP69 Robust performance
even in harsh
environments

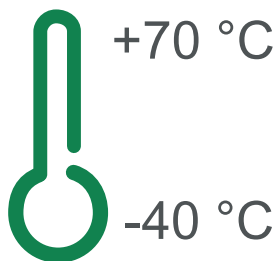

Marine environment
Click to open video (42 sec)

Robustness

Harmony XB4 delivers extremely robust performance even in severe environments.

Improved reliability of panels, machines, and processes

- > Sealing effectiveness rated up to IP66, IP67, IP68, IP69, IP69K, and type 4X
- > High impact resistance up to IK06 rating
- > Operating temperature ranging from -40 to +70 °C / -40 to +158 °F
- > Compliance with international standards (IEC, UL, CCC, EAC, JIS)
- > Marine certified (BV, LROS, BDNV, GL)

High electrical performance

- > Contacts and heads designed to prevent vibration, helping to ensure secure mounting and wiring
- Choose from standard, low-load, and high-power electrical contacts

Lower maintenance

- > Harmony pushbuttons are designed to perform up to 10 million operations.
- This represents more than 1,000 operations a day for 27 years.

Adapted to your applications, segments, and operating environments

Harmony offers a unique and unrivalled depth of range delivering products adapted to your applications, segments, and operating environments.



Material working



Packaging



Pumping



Consumer packaged goods



Water & waste water



Oil & Gas



Material handling

Control and signaling units

Harmony XB4, metal

Pushbuttons, switches, and pilot lights



Harmony XB4 range of control and signaling units for Ø 22 mm/0.866 in. mounting

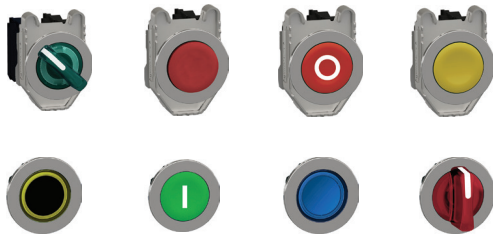

Harmony XB4 flush mounted control and signaling units for Ø 30 mm/1.181 in mounting

Presentation

The Harmony® XB4 metal range of modular control and signaling units combines simplicity of installation, flexibility, and robustness. It meets the requirements of the majority of industrial applications. These units are either available as complete products or separate components for customer assembly.

This range includes:

- Pushbuttons, selector/key switches, Emergency stop functions, and multiple-headed pushbuttons designed for parameter settings, adjustments, and start/stop control of machines and installations
- Pilot lights, illuminated pushbuttons, illuminated selector switches, and illuminated Emergency stop functions designed for visual signaling
- Various accessories including:
 - Flush mounting kits:
 - redesigned, improving the look of the control panel
 - quick and easy installation in a 30.5 mm/1.20 in. hole making it compatible with 22 mm/0.87 in. devices
 - a cost-effective solution, as the control devices and the operating modes of the machine do not change
 - Other accessories: protective covers, legends and legend holders, pushbutton caps, boots, bulbs, etc.

The pushbutton and switch control offer (illuminated and non-illuminated) is both broad and comprehensive:

- Pushbuttons, spring return with flush push, projecting push, recessed push, booted flush push, or mushroom head
- Emergency stop pushbuttons with 3 types of head: push-pull, turn to release, and key release
- Pilot lights and illuminated pushbuttons with integral LED and BA 9s base fitting bulbs
- Selector switches with different types of operator: standard handle, long handle, knurled knob, or key
- Choice of heads: square, circular, rectangular, double-head/triple-head rectangular, or toggle
- Colors of push: white, black, green, orange, blue, red, or yellow
- Connection type: screw clamp connector, Faston connector, spring terminal, or for printed circuit board
- Contact blocks for general purpose or specific applications (low current, standard, or high power switching)
- Choice of heads to meet the majority of industrial needs: from the most basic pushbuttons and pilot lights, to functions meeting modern machine requirements, such as USB & RJ45 ports
- Wide choice of accessories and spare parts
- Other specific functions: complete potentiometer, hour counters, annunciator, or joystick controllers

Innovative complementary offers are also available:

- Control and signaling units for severe applications
- Wireless and batteryless pushbuttons
- Biometric switches

Control and signaling units

Harmony XB4, metal

Pushbuttons, switches, and pilot lights

Installation

Harmony XB4 products are both simple and quick to install:

- Mounting by single installer (self-maintaining head in its cut-out)
- Clip-together component system (head, body, contact blocks, and LED)
- Anti-loosening system for screw clamp terminals on contact blocks

Harmony XB4 standard mounting products are installed with or without a notch in a $\text{Ø} 22 \text{ mm}/0.866 \text{ in.}$ hole, thanks to the self-cleavable orientation pin.

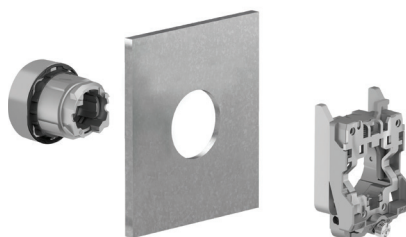

For installation of Harmony XB4 standard mounting products

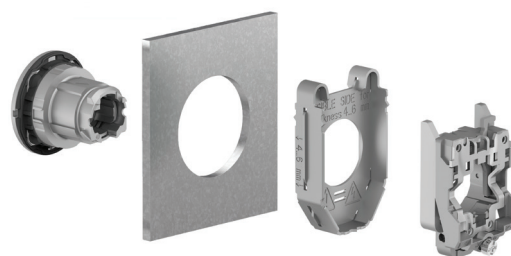

For installation of Harmony XB5 flush mounting products

Harmony XB4 flush mounting products are installed without a notch in a $\text{Ø} 30 \text{ mm}/1.181 \text{ in.}$ hole. This gives flush mounting products the same actuating area as that of standard mounting products, offering optimized ergonomics for operators even when wearing gloves.

Flush solutions mounted in a $\text{Ø} 22 \text{ mm}/0.866 \text{ in.}$ hole can be achieved using the Harmony XB6 range. Please refer to the Harmony XB6 catalog for details.

Environment

The performance of the Harmony XB4 range meets some of the most demanding international standards and approvals:

- Certified and approved for meeting requirements throughout all continents: EN/IEC, CE marking, UL, CSA, CCC, EAC, JIS, NEMA, and marine approvals
- Protection against ingress of solid objects, dust, and water: IP66, IP67, IP69, IP69K, type 4X
- Operating temperature range from -40 °C to $+70 \text{ °C}/-40 \text{ °F}$ to $+158 \text{ °F}$ for outdoor applications
- Shock protection level up to IK06
- High vibration resistance with shakeproof connection screws (periodic retightening unnecessary)

Control and signaling units

Harmony XB4, metal

Pushbuttons, switches, and pilot lights

Complete units, XB4B

Complete units

Contact functions

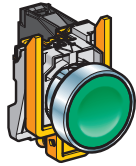

Flush push, unmarked
XB4BA●1/BA42
see [page 26](#)

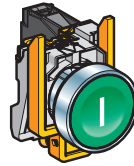

Flush push, with marking
XB4BA●3●●
see [page 29](#)

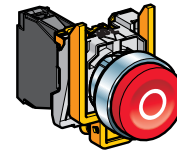

Projecting push, with marking
XB4BL4325
see [page 29](#)



Booted flush push
XB4BP●1/BP42
see [page 28](#)

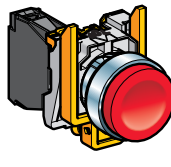

Projecting push, unmarked
XB4BL42
see [page 27](#)

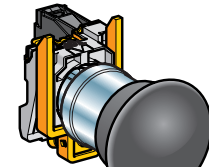

Ø 40 mm/
1.57 in.

Mushroom head
XB4BC21
see [page 42](#)

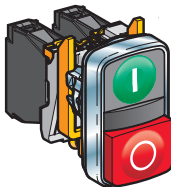

Multiple-headed
pushbuttons, spring return,
with chromium plated metal
bezel

Double-headed
XB4BL73415
see [page 40](#)

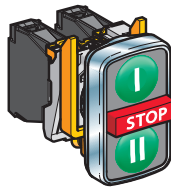

Triple-headed
XB4BA731327/XB4BA711237
see [page 41](#)

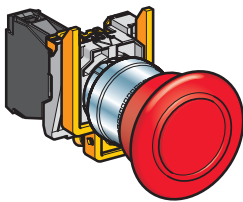

Ø 40 mm/
1.57 in.

Emergency stop or
Emergency switching off
mushroom head
pushbuttons, Ø 40 mm/
1.57 in., with chromium
plated metal bezel

Emergency stop trigger action and mechanical latching
Push-pull (EN/ISO 13850)
XB4BT845
see [page 44](#)

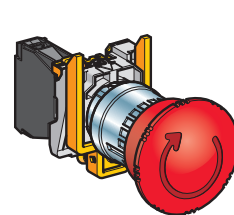

Ø 40 mm/
1.57 in.

Emergency stop trigger action and mechanical latching
Turn to release (EN/ISO 13850)
XB4BS844●
see [page 44](#)

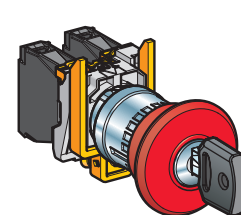

Ø 40 mm/
1.57 in.

Emergency stop trigger action and mechanical latching
Key release (EN/ISO 13850)
XB4BS9445
see [page 44](#)

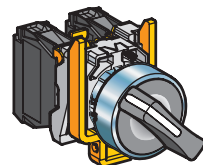

Selector switches and key
switches, with chromium
plated metal bezel

Standard handle, black
XB4BD●●
see [page 54](#)

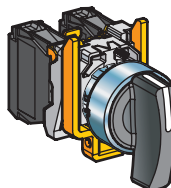

Long handle, black
XB4BJ●●
see [page 55](#)

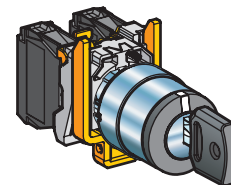

Key switch
XB4BG●●
see [page 56](#)

Control and signaling units

Harmony XB4, metal

Pushbuttons, switches, and pilot lights

Complete units, XB4B

Complete units

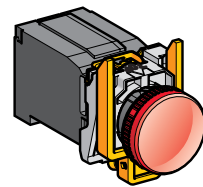
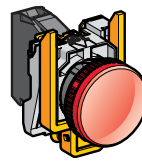
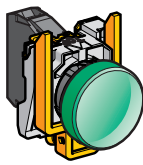

Pilot lights

Integral LED
XB4BV3●/BVG●/BVM●
see [page 66](#)

For bulb with BA 9s base fitting
Direct supply
XB4BV6●
see [page 68](#)

Via integral transformer with secondary
XB4BV3●/BV4●
see [page 68](#)

Combined functions (contact and signaling)

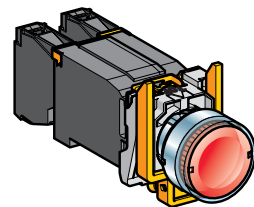
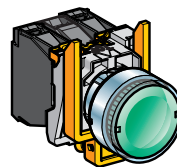
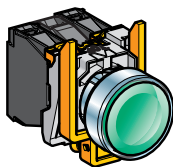

Illuminated pushbuttons,
spring return, flush push,
chromium plated metal bezel

Integral LED
XB4BW3●B5/BW3●G5/BW3●M5
see [page 30](#)

For bulb with BA 9s base fitting
Direct supply
XB4BW3●65
see [page 33](#)

Via integral transformer
XB4BW3●35/BW3●45
see [page 33](#)

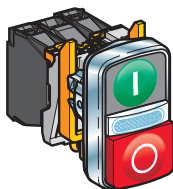

Double-headed pushbuttons
+ pilot light block, spring
return, chromium plated
metal bezel

Integral LED
XB4BW73731●5
see [page 40](#)

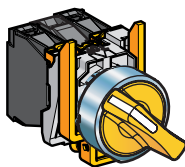

Illuminated selector switches
with standard handle,
chromium plated metal bezel

Integral LED
XB4BK12●5, XB4BK13●5
see [page 58](#)

Control and signaling units

Harmony XB4, metal

Pushbuttons, switches, and pilot lights

Complete units, XB4F flush mounting

Complete units

Contact functions for Ø 30 mm mounting

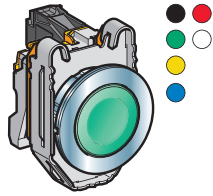

Pushbuttons, spring return, with chromium plated metal bezel

Flush push, unmarked

XB4FA●1/FA42
see [page 34](#)

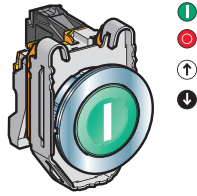

Flush push, with marking

XB4FA●3●●
see [page 36](#)

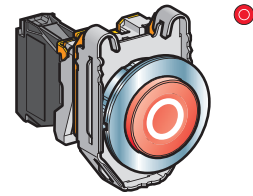

Projecting push, with marking

XB4FL4325
see [page 36](#)

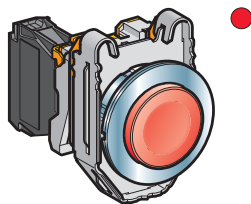

Pushbuttons, spring return, with chromium plated metal bezel

Projecting push, unmarked

XB4FL42
see [page 35](#)

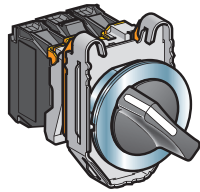

Selector switches and key switches, with chromium plated metal bezel

Standard handle, black

XB4FD●●
see [page 60](#)

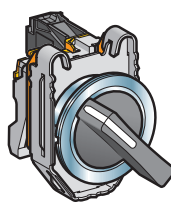

Long handle, black

XB4FJ●●
see [page 61](#)

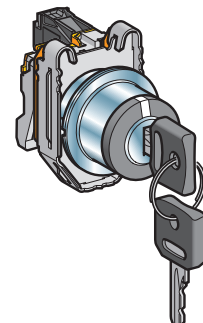

Key switch

XB4FG●●
see [page 62](#)

Complete units

Signaling functions for Ø 30 mm mounting



Pilot lights

Integral LED

XB4FVB●/FVG●/FVM●
see [page 70](#)

Combined functions (contact and signaling) for Ø 30 mm mounting

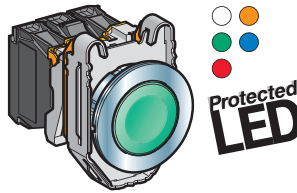

Illuminated pushbuttons, spring return, flush push, chromium plated metal bezel

Integral LED

XB4FW3●B5/FW3●G5/FW3●M5
see [page 37](#)

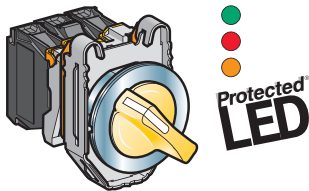

Illuminated selector switches with standard handle, chromium plated metal bezel

Integral LED

XB4FK12●●5, XB4FK13●●5
see [page 64](#)

Control and signaling units

Harmony XB4, metal

Pushbuttons, switches, and pilot lights

Sub-assemblies, ZB4B

Non illuminated units for user assembly

For pushbuttons, spring return, unmarked

Body sub-assemblies

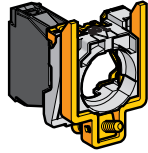

Screw clamp terminals
ZB4BZ10●/BZ141
see [page 76](#)

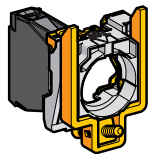

Faston
ZB4BZ10●3
see [page 80](#)

For pushbuttons, spring return, with marking

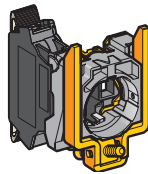

Spring clamp terminals
ZBE10●5
ZB4BZ10●5
see [page 78](#)

For multiple-headed pushbuttons, spring return

For "push-push to release" pushbuttons

Flush push
ZB4BA●3●/BA●4●
ZB4BA334/335
see [page 29](#)

Projecting push
ZB4BL●3●
see [page 29](#)



Double-headed pushbuttons
ZB4BA7●●●
ZB4BA79
ZB4BL734●
see [page 40](#)

Triple-headed pushbuttons
ZB4BA7313●
ZB4BA711●●
ZB4BA72124
ZB4BA791
see [page 41](#)

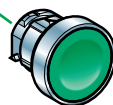

Flush push
ZB4BH0●
see [page 50](#)

Projecting push
ZB4BH●
see [page 50](#)

Contact functions

Head sub-assemblies, chromium plated or black metal bezel

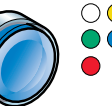
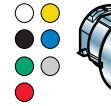
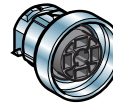
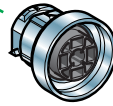

Flush push without cap
ZB4BA0
see [page 26](#)

Flush push with set of 6 caps
ZB4BA9
see [page 26](#)

Flush push
ZB4BA●
see [page 26](#)

Flush push for insertion of legend
ZB4BA●8
see [page 26](#)

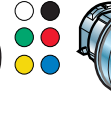

Projecting push
ZB4BL●
see [page 27](#)

Recessed push
ZB4BA●6
see [page 28](#)

Booted flush/projecting push
ZB4BP●/BP●S
see [page 28](#)

Booted flush push for insertion of legend
ZB4BP●8
see [page 28](#)



Flush push
ZB4BA●3●/BA●4●
ZB4BA334/335
see [page 29](#)



Projecting push
ZB4BL●3●
see [page 29](#)

Control and signaling units

Harmony XB4, metal

Pushbuttons, switches, and pilot lights

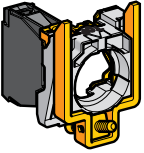
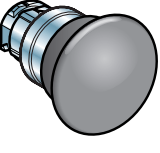
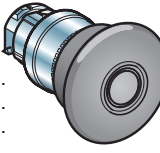
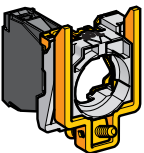
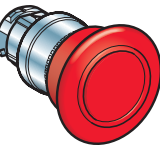
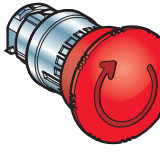
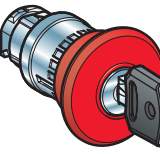
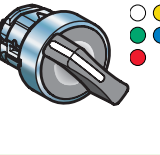
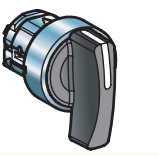
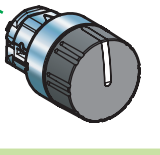
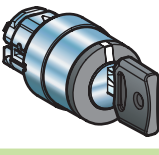
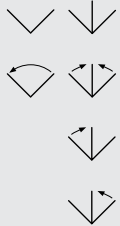
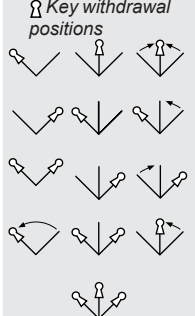
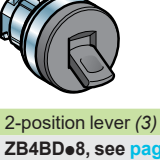
Sub-assemblies, ZB4B

Non illuminated units for user assembly (continued)	Contact functions	
For mushroom head pushbuttons	Body sub-assemblies	Head sub-assemblies, chromium plated or black metal bezel
<p>Screw clamp terminals ZB4BZ10●/BZ141 see page 76</p>		<div style="display: flex; justify-content: space-around;"> <div style="text-align: center;">  <p>Spring return ZB4BC●/BR● see page 42</p> </div> <div style="text-align: center;">  <p>Latching ZB4B●2/BS●2/BS55 see page 43</p> </div> </div> <p style="text-align: center;"> ● ● ● ● </p> <p> Ø 30 mm/1.181 in. Ø 40 mm/1.575 in. Ø 60 mm/2.362 in. </p>
<p>For Emergency Stop or Emergency switching off mushroom head pushbuttons</p>		<div style="display: flex; justify-content: space-around;"> <div style="text-align: center;">  <p>Push-pull (EN/ISO 13850) ZB4BT84 see page 45</p> </div> <div style="text-align: center;">  <p>Turn to release (EN/ISO 13850) ZB4BS8●4 see page 45</p> </div> </div> <p style="text-align: center;"> ● </p> <p> Ø 30 mm/1.181 in. Ø 40 mm/1.575 in. Ø 60 mm/2.362 in. </p>
<p>Emergency stop trigger action and mechanical latching</p>	<p>Faston ZB4BZ10●3 see page 80</p>	<div style="text-align: center;">  <p>Key release (EN/ISO 13850) ZB4BS9●4 see page 45</p> </div> <p style="text-align: center;"> ● </p> <p> Ø 30 mm/1.181 in. Ø 40 mm/1.575 in. Ø 60 mm/2.362 in. </p>
<p>Emergency stop trigger action and mechanical latching</p>	<p>Spring clamp terminals ZBE10●5 ZB4BZ10●5 see page 78</p>	<div style="display: flex; justify-content: space-around;"> <div style="text-align: center;">  <p>Standard black handle (1) ZB4BD● see page 54</p> </div> <div style="text-align: center;">  <p>Long black handle (1) ZB4BJ● see page 55</p> </div> </div> <div style="display: flex; justify-content: space-around; margin-top: 20px;"> <div style="text-align: center;">  <p>Knurled black knob (1) ZB4BD●9 see page 57</p> </div> <div style="text-align: center;">  <p>Key switch (2) ZB4BG●●/ BG●TEC10 see page 57</p> </div> </div> <div style="margin-top: 20px;"> <p>(1) Switch handle and knob positions</p>  <p>(2) Key switch positions Key withdrawal positions</p>  </div>
<p>For toggle switches</p>		<div style="text-align: center;">  <p>2-position lever (3) ZB4BD●8, see page 57</p> </div> <div style="margin-top: 20px;"> <p>(3) Lever positions</p>  </div>

Control and signaling units

Harmony XB4, metal

Pushbuttons, switches, and pilot lights

Sub-assemblies, ZB4B

Pilot lights for user assembly

Signaling functions

Body sub-assemblies with integral LED

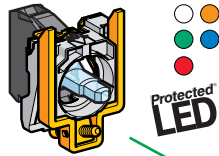

Connection: screw clamp terminals
ZB4BVJ●/BVB●/BVG●/ BVM●
 see [page 84](#)

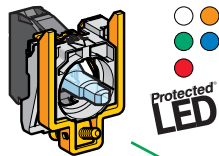

Connection: plug-in connector
ZB4VB●4/BVG●4/ BVM●4
 please contact our Customer Care Center

Head sub-assemblies



With lens fitted
ZB4BV0●3
 see [page 67](#)

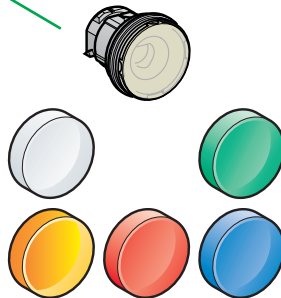

With 5 separate lenses, not fitted
ZB4BV003
 see [page 67](#)

Body sub-assemblies for BA 9s bulb



Direct supply
 Connection: screw clamp terminals
ZB4BV6
 see [page 87](#)

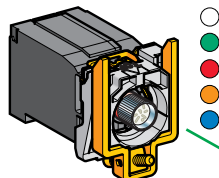

Via integral transformer
 Connection: screw clamp terminals
ZB4BV●D●
 see [page 87](#)

Head sub-assemblies

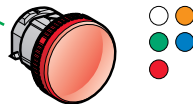









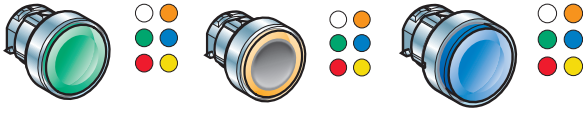

With lens fitted
ZB4BV0●, ZB4BV0●S
 see [page 68](#)

Control and signaling units

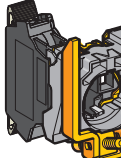
Harmony XB4, metal

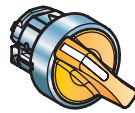
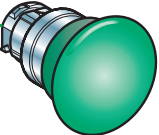
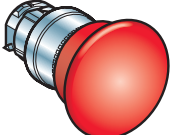
Pushbuttons, switches, and pilot lights

Sub-assemblies, ZB4B

Illuminated pushbuttons for user assembly	Combined functions (contact and signaling)	
For illuminated pushbuttons, spring return	Body sub-assemblies with integral LED  <p>Screw clamp terminals ZB4BW0B●●/BW0G●●/BW0M●● see page 82</p> 	Head sub-assemblies, chromium plated or black metal bezel  <p>Flush push ZB4BW3●3 see page 31</p> <p>Flush push with illuminated ring ZB4BW9●3 see page 31</p> <p>Flush push for insertion of legend ZB4BA●8 see page 31</p>
For illuminated double-headed pushbuttons, spring return	Plug-in connector ZB4BW0B●●4 please contact our Customer Care Center	 <p>Double-headed (flush/flush push) + central pilot light Double-headed (flush/projecting push) + central pilot light ZB4BW7A17●● / ZB4BW7A374● / ZB4BW7A9, see page 40 ZB4BW7L374●, see page 40</p>
For illuminated "push-push to release" pushbuttons and illuminated selector switches with standard handle	 <p>Spring clamp terminals ZBV●●● see page 78</p>	 <p>Flush or projecting "push-push to release" ZB4BH0●3/BH●3 see page 51</p>  <p>Selector switches with standard handle ZB4BK1●●3 see page 59</p>
For illuminated mushroom head pushbuttons	 <p>Mushroom head, latching ZB4BW6●3 see page 43</p>	 <p>Emergency switching off, mechanical latching, push-pull ZB4BW643 see page 47</p>
For illuminated pushbuttons, spring return	Body sub-assemblies for BA 9s bulb  <p>Direct supply or via integral transformer Screw clamp terminals ZB4BW0●●● see page 86</p>	Head sub-assemblies, chromium plated or black metal bezel  <p>Flush push ZB4BW3●, ZB4BW3●S see page 33</p>  <p>Projecting push ZB4BW1●, ZB4BW1●S see page 33</p>

Control and signaling units

Harmony XB4, metal

Pushbuttons, switches, and pilot lights

Sub-assemblies, ZB4F flush mounting heads

Non illuminated units for user assembly

Contact functions for Ø 30 mm mounting

For pushbuttons, spring return, unmarked

Body sub-assemblies



Screw clamp terminals
ZB4BZ10●/BZ141
see [page 76](#)

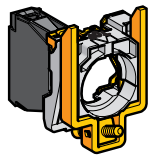

Faston
ZB4BZ10●3
see [page 80](#)

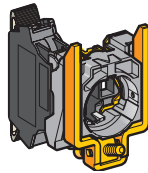

Spring clamp terminals
ZBE10●5
ZB4BZ10●5
see [page 78](#)

For pushbuttons, spring return, with marking

For "push-push to release" pushbuttons

Head sub-assemblies, chromium plated or black metal bezel

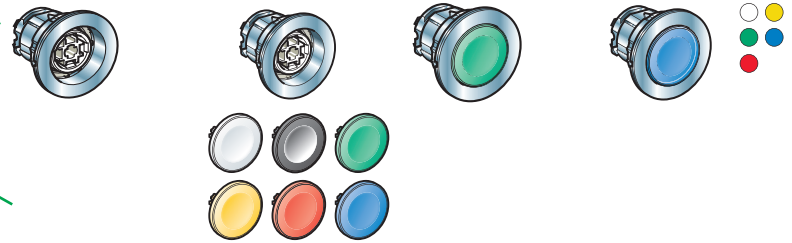

Flush push without cap
ZB4FA0
see [page 34](#)

Flush push with set of 6 caps
ZB4FA9
see [page 34](#)

Flush push
ZB4FA●
see [page 34](#)

Flush push for insertion of legend
ZB4FA●8
see [page 34](#)

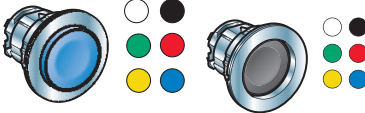

Projecting push
ZB4FL●
see [page 35](#)

Recessed push
ZB4FA●6
see [page 34](#)

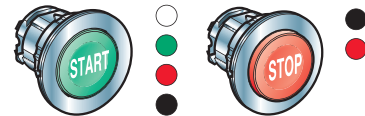

Flush push
ZB4FA●3●/FA●4●
ZB4FA334/335
see [page 36](#)

Projecting push
ZB4FL●3●
see [page 36](#)

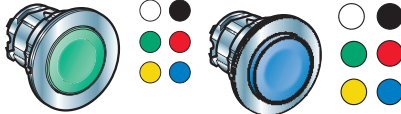

Flush push
ZB4FH0●
see [page 52](#)

Projecting push
ZB4FH●
see [page 52](#)

Control and signaling units

Harmony XB4, metal

Pushbuttons, switches, and pilot lights

Sub-assemblies, ZB4F flush mounting heads

Non illuminated units for user assembly (continued)

Contact functions for Ø 30 mm mounting

For selector switches and key switches

Body sub-assemblies

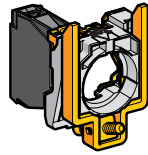

Screw clamp terminals
ZB4BZ10●/BZ141
see [page 76](#)

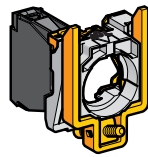

Faston
ZB4BZ10●3
see [page 80](#)

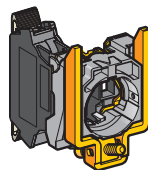

Spring clamp terminals
ZBE10●5
ZB4BZ10●5
see [page 78](#)

Head sub-assemblies, chromium plated or black metal bezel

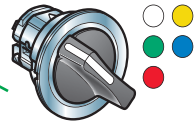

Standard black handle (1)
ZB4FD●
see [page 60](#)



Long black handle (1)
ZB4FJ●
see [page 61](#)

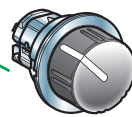

Knurled black knob (1)
ZB4FD●9
see [page 63](#)

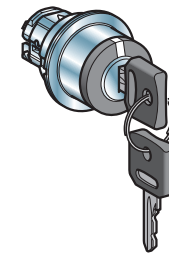

Key switch (2)
ZB4FG●●
see [page 62](#)

(1) Switch handle and knob positions

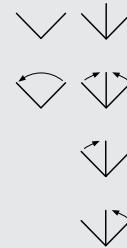

(2) Key switch positions
Key withdrawal positions

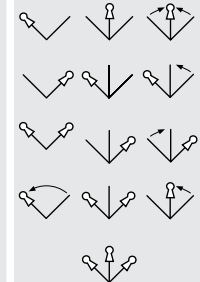

Control and signaling units

Harmony XB4, metal

Pushbuttons, switches, and pilot lights

Sub-assemblies, ZB4F flush mounting heads

Pilot lights for user assembly

Signaling functions for Ø 30 mm mounting

Body sub-assemblies with integral LED

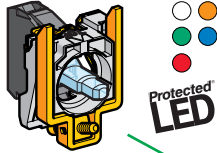

Connection: screw clamp terminals

ZB4BVJ●/BVB●/BVG●/
BVM●
see [page 84](#)

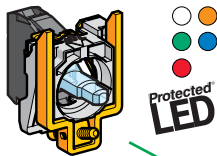

Connection: plug-in connector

ZB4VB●4/BVG●4/
BVM●4
please contact our
Customer Care Center

Head sub-assemblies

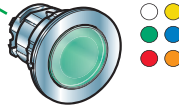

With lens fitted

ZB4FV0●3
see [page 71](#)

Control and signaling units

Harmony XB4, metal

Pushbuttons, switches, and pilot lights

Sub-assemblies, ZB4F flush mounting heads

Illuminated pushbuttons for user assembly

For illuminated pushbuttons, spring return

For illuminated "push-push to release" pushbuttons and illuminated selector switches with standard handle

Combined functions (contact and signaling) for Ø 30 mm mounting

Body sub-assemblies with integral LED



Screw clamp terminals
ZB4BW0B●●/BW0G●●/
BW0M●●
see [page 82](#)



Plug-in connector
ZB4BW0B●●4
please contact our
Customer Care Center

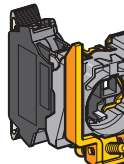

Spring clamp terminals
ZBV●●●
see [page 78](#)

Head sub-assemblies, chromium plated or black metal bezel

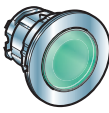

Flush push

ZB4FW3●3
see [page 38](#)

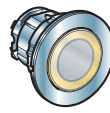

Flush push with illuminated ring

ZB4FW9●3
see [page 38](#)

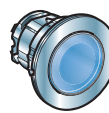

Flush push for insertion of legend

ZB4FA●8
see [page 38](#)

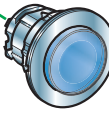

Projecting push

ZB4FW1●3
see [page 39](#)

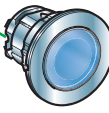

Flush or projecting "push-push to release"

ZB4FH0●3/FH●3
see [page 53](#)

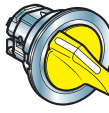

Selector switches with standard handle

ZB4FK1●●3
see [page 65](#)

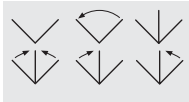

Control and signaling units

Harmony XB4 metal
Contact mounting - Contact sequence

Maximum recommended configurations to help ensure compliance with catalog characteristics

Unit type (complete units XB4B and XB4F, heads ZB4B and ZB4F)	Pushbuttons, spring return XB4BA, ZB4BA, XB4FA, ZB4FA, (except ZB4BA8 and ZB4FA8) XB4BC, ZB4BC, XB4BL, ZB4BL, XB4BP, ZB4BP, ZB4BR, XB4FL, ZB4FL	Double-headed pushbuttons XB4BL73415, ZB4BA712, ZB4B734, ZB4BA79	Illuminated pushbuttons, spring return XB4BW, ZB4BW, ZB4BA8 Double-headed pushbuttons + pilot light block XB4BW737315, ZB4BW7A17, ZB4BW7374, ZB4BW7A9	
Solution using single contacts				
Solution using single and double contacts				
Maximum recommended configurations	Single contacts Double contacts + single contacts Light block	9 3 + 3 -	6 2 + 2 -	6 2 + 2 1

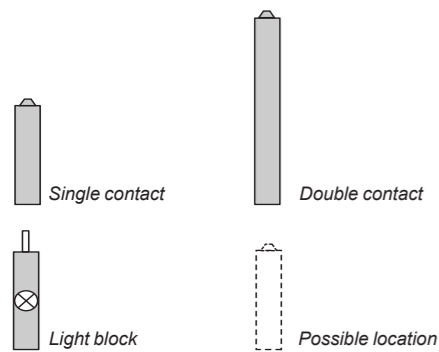

Possible configurations for high power switching contacts (1) (2)

High power switching contact blocks with screw clamp terminal connections: ZBE501, ZBE502, ZBE503, ZBE504 and ZBE505
High power switching contact blocks with connection by Faston connectors: ZBE5013, ZBE5023, ZBE5033, ZBE5043 and ZBE5053

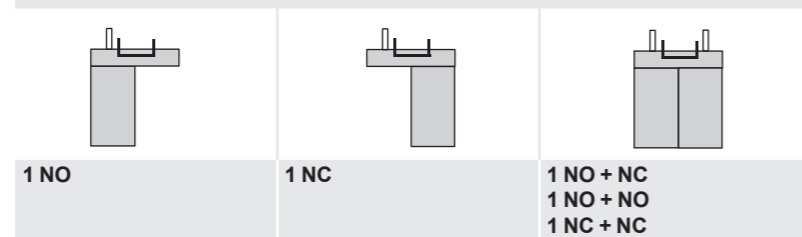

(1) The configurations are not upgradable and cannot be combined with other types of contact and signaling functions.
(2) High power switching contacts are not compatible with Harmony triple-headed pushbuttons.

Emergency stop or Emergency switching off XB4BT, ZB4BT, XB4BS, ZB4BS

Emergency stop or Emergency switching off XB4BT, ZB4BT, XB4BS, ZB4BS	Selector switches <ul style="list-style-type: none"> Standard handle XB4BD, ZB4BD, XB4FD, ZB4FD Long handle XB4BJ, ZB4BJ, XB4FJ, ZB4FJ Knurled knob ZB4BD9, ZB4FD9 Key switch XB4BG, ZB4BG, XB4FG, ZB4FG 	Illuminated selector switches, standard handle XB4BK, ZB4BK, XB4FK, ZB4FK	Toggle switches ZB4BD8	Pushbuttons, push-push ZB4BH, ZB4FH	Illuminated pushbuttons, push-push ZB4BH3, ZB4FH3
4 2 + 0 -	4 1 + 2 -	5 2 + 1 -	4 1 + 2 -	6 2 + 2 1	4 2 + 0 -
6 3 + 0 -	3 -	3 -	3 -	3 -	2 -
1 -	1 -	1 -	1 -	1 -	1 -

Sequence of contacts on selector switch bodies

Unit type	Selector switches	
	2-position	3-position
Push	Position Top	
	Position Bottom	
Contacts	Location	
	State	
	NO	
	NC	







L left, C center, R right
□ open ■ closed

Assembly of other products using:
 Body/contact assemblies: see [page 76](#)
 Accessories: see [page 90](#)

Control and signaling units

Harmony XB4, metal

Spring return pushbuttons, unmarked

Pushbuttons with flush push (1)						
Screw clamp terminal connections (Schneider Electric anti-loosening system)						
Shape of head	Type of push	Type of contact		Color of push	Reference	Weight kg/lb
						
		NO	NC			
Complete units (2)						
	Flush	1	–	White	XB4BA11 (ZB4BZ101 + ZB4BA1)	0.080/0.176
				Black	XB4BA21 (6) (ZB4BZ101 + ZB4BA2)	0.080/0.176
				Green	XB4BA31 (6) (ZB4BZ101 + ZB4BA3)	0.080/0.176
				Yellow	XB4BA51 (ZB4BZ101 + ZB4BA5)	0.080/0.176
				Blue	XB4BA61 (ZB4BZ101 + ZB4BA6)	0.080/0.176
		–	1	Red	XB4BA42 (6) (ZB4BZ102 + ZB4BA4)	0.080/0.176
Heads only						
	Without cap (3)			–	ZB4BA0	0.028/0.062
	Flush, with set of 6 colored caps			6 colors (4)	ZB4BA9	0.038/0.084
	Flush (2)			White	ZB4BA1	0.029/0.064
				Black	ZB4BA2	0.029/0.064
				Green	ZB4BA3	0.029/0.064
				Red	ZB4BA4	0.029/0.064
				Yellow	ZB4BA5	0.029/0.064
				Blue	ZB4BA6	0.029/0.064
				Gray	ZB4BA8	0.029/0.064
	Flush with transparent cap for insertion of legend (5)			White	ZB4BA18	0.028/0.062
				Green	ZB4BA38	0.028/0.062
				Red	ZB4BA48	0.028/0.062
				Yellow	ZB4BA58	0.028/0.062
				Blue	ZB4BA68	0.028/0.062
	illuminated flush pushbutton head, with set of 6 colored caps			6 colors	ZB4BA98	0.022/0.049
	Flush (high bezel) (2)			White	ZB4BA14	0.034/0.075
				Black	ZB4BA24	0.034/0.075
				Green	ZB4BA34	0.034/0.075
				Red	ZB4BA44	0.034/0.075
				Yellow	ZB4BA54	0.034/0.075
				Blue	ZB4BA64	0.034/0.075

Heads with black metal bezel

To order, add a 7 to the references selected from above.
 Example: **ZB4BA0** becomes **ZB4BA07**.

- (1) For recommended maximum number of contacts constituting the body (fixing collar and contact) associated with the head, see [page 24](#).
- (2) To add customized markings on these references using the web customization tool, see [page 5](#).
- (3) Colored cap to be ordered separately (see [page 90](#)).
- (4) Head supplied with 6 different colored caps (white, black, green, red, yellow, and blue) not fitted.
- (5) For legend ordering information, see [page 100](#).
- (6) To order products with 1NO and 1NC contact, replace the last digit of the commercial reference with a 5, example: XB4BA21 becomes XB4BA25

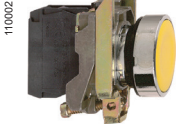

XB4BA51



ZB4BA0



ZB4BA4

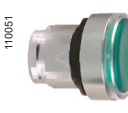

ZB4BA38



ZB4BA98







ZB4BA34

Assembly of other products using:
 Body/contact assemblies: see [page 76](#)
 Accessories: see [page 90](#)

Control and signaling units

Harmony XB4, metal

Spring return pushbuttons, unmarked

Pushbuttons with projecting push ⁽¹⁾ ⁽²⁾						
Screw clamp terminal connections (Schneider Electric anti-loosening system)						
Shape of head	Type of push	Type of contact		Color of push	Reference	Weight kg/lb
						
		NO	NC			
Complete units						
	Projecting	-	1	Red	XB4BL42 (ZB4BZ102 + ZB4BL4)	0.081/0.179
Heads only						
	Projecting			White	ZB4BL1	0.030/0.066
				Black	ZB4BL2	0.030/0.066
				Green	ZB4BL3	0.030/0.066
				Red	ZB4BL4	0.030/0.066
				Yellow	ZB4BL5	0.030/0.066
				Blue	ZB4BL6	0.030/0.066

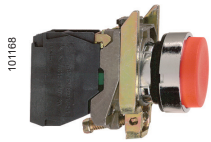

101168

XB4BL42



101217

ZB4BL1

(1) For recommended maximum number of contacts constituting the body (fixing collar and contact) associated with the head, see [page 24](#).

(2) To add customized markings on these references using the web customization tool, see [page 5](#).

Assembly of other products using:
 Body/contact assemblies: see page 76
 Accessories: see page 90

Control and signaling units

Harmony XB4, metal

Spring return pushbuttons, unmarked

101197



ZB4BA36

Pushbuttons with recessed push (1) (2)				
High guard				
Shape of head	Type of push	Color	Reference	Weight kg/lb
Heads only				
	Recessed (high guard)	White	ZB4BA16	0.034/0.075
		Black	ZB4BA26	0.034/0.075
		Green	ZB4BA36	0.034/0.075
		Red	ZB4BA46	0.034/0.075
		Yellow	ZB4BA56	0.034/0.075
		Blue	ZB4BA66	0.034/0.075

110099

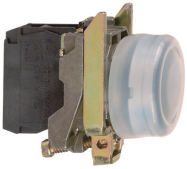

XB4BP21

Pushbuttons with silicone booted head for severe environments (1)							
Screw clamp terminal connections (Schneider Electric anti-loosening system)							
Shape of head	Type of push	Type of contact		Color of push	Reference	Weight kg/lb	
		NO	NC				
Complete units (2)							
	Booted, clear silicone (color of push unobscured)	1	–	Black	XB4BP21 (ZB4BZ101 + ZB4BP2)	0.082/0.181	
				Green	XB4BP31 (ZB4BZ101 + ZB4BP3)	0.082/0.181	
					Yellow	XB4BP51 (ZB4BZ101 + ZB4BP5)	0.082/0.181
					Blue	XB4BP61 (ZB4BZ101 + ZB4BP6)	0.082/0.181
			–	1	Red	XB4BP42 (ZB4BZ102 + ZB4BP4)	0.082/0.181

110054



ZB4BP18

Silicone booted heads only, with increased protection (IP69K)					
	Flush	Clear boot (3) For insertion of protected legend within head (4)	White	ZB4BP18 (2)	0.034/0.075
			Green	ZB4BP38 (2)	0.034/0.075
			Red	ZB4BP48	0.034/0.075
			Yellow	ZB4BP58 (2)	0.034/0.075
			Blue	ZB4BP68	0.034/0.075
	Projecting	Clear boot (3) (2)	White	ZB4BP1	0.031/0.068
			Black	ZB4BP2 (6)	0.031/0.068
			Green	ZB4BP3 (6)	0.031/0.068
			Red	ZB4BP4 (6)	0.031/0.068
			Yellow	ZB4BP5	0.031/0.068
			Blue	ZB4BP6	0.031/0.068

103542



ZB4BP2S

Silicone booted heads only, standard for mouting with legend holder (IP66)					
	Flush	Colored boot (5)	White	ZB4BP1S	0.034/0.075
			Black	ZB4BP2S	0.034/0.075
			Green	ZB4BP3S	0.034/0.075
			Red	ZB4BP4S	0.034/0.075
			Yellow	ZB4BP5S	0.034/0.075
			Blue	ZB4BP6S	0.034/0.075

PG13450



ZB4BP183

		Clear membrane (5) (2) For insertion of protected legend within head (4)	White	ZB4BP183	0.026/0.057
			Green	ZB4BP383	0.026/0.057
			Red	ZB4BP483	0.026/0.057
			Yellow	ZB4BP583	0.026/0.057
			Blue	ZB4BP683	0.026/0.057

Heads with black metal bezel

To order, add a 7 to the references selected from above.

Example: **ZB4BP18** becomes **ZB4BP187**.

(1) For recommended maximum number of contacts constituting the body (fixing collar and contact) associated with the head, see page 24.

(2) To add customized markings on these references using the web customization tool, see page 5.

(3) Permissible panel thickness 1 to 5 mm/0.039 to 0.197 in., cannot be used with legend holders.

(4) To order a legend for insertion within the head, see page 100.









(5) For replacement of silicone protection element without dismantling head, see page 92.

(6) To order a flush push type product, insert «A» before the last digit of the commercial reference, example: ZB4BP2 becomes ZB4BPA2.

Control and signaling units

Harmony XB4, metal

Spring return pushbuttons, with marking

Pushbuttons with flush or projecting push (1)							
Screw clamp terminal connections (Schneider Electric anti-loosening system)							
Shape of head	Type of push	Type of contact		Marking Text (color)	Color of push	Reference	Weight kg/lb
		N/O	N/C				
Complete units							
	Flush	1	–	"I" (White)	Green	XB4BA3311 (ZB4BZ101 + ZB4BA331)	0.080/0.176
	Flush	–	1	"O" (White)	Red	XB4BA4322 (ZB4BZ102 + ZB4BA432)	0.080/0.176
	Projecting	1	1	"O" (White)	Red	XB4BL4325 (ZB4BZ105 + ZB4BL432)	0.080/0.176
	Flush (2)	1	–	↑ (Black)	White	XB4BA3341 (ZB4BZ101 + ZB4BA334)	0.080/0.176
	Flush (2)	1	–	↓ (White)	Black	XB4BA3351 (ZB4BZ101 + ZB4BA335)	0.080/0.176
Heads only							
	Flush			"I" (White)	Green	ZB4BA331	0.029/0.064
				"I" (Black)	White	ZB4BA131	0.029/0.064
				"II" (White)	Green	ZB4BA336	0.029/0.064
				"II" (Black)	White	ZB4BA136	0.029/0.064
				"START" (white)	Green	ZB4BA333	0.029/0.064
				"START" (Black)	White	ZB4BA133	0.029/0.064
				"ON" (White)	Green	ZB4BA341	0.029/0.064
				"ON" (Black)	White	ZB4BA141	0.029/0.064
				"MARCHE" (White)	Green	ZB4BA342	0.029/0.064
				"MARCHE" (Black)	White	ZB4BA142	0.029/0.064
				 (White)	Black	ZB4BA245	0.029/0.064
				 (Black)	White	ZB4BA145	0.029/0.064
				"O" (White)	Red	ZB4BA432	0.029/0.064
					Black	ZB4BA232	0.029/0.064
				"ARRET" (White)	Red	ZB4BA433	0.029/0.064
					Black	ZB4BA233	0.029/0.064
				"STOP" (White)	Red	ZB4BA434	0.029/0.064
					Black	ZB4BA234	0.029/0.064
				"OFF" (White)	Red	ZB4BA435	0.029/0.064
					Black	ZB4BA235	0.029/0.064
		↑ (Black) (2)	White	ZB4BA334	0.029/0.064		
		↓ (White) (2)	Black	ZB4BA335	0.029/0.064		
	Projecting			"O" (White)	Red	ZB4BL432	0.030/0.066
					Black	ZB4BL232	0.030/0.066
				"ARRET" (White)	Red	ZB4BL433	0.030/0.066
					Black	ZB4BL233	0.030/0.066
				"STOP" (White)	Red	ZB4BL434	0.030/0.066
					Black	ZB4BL234	0.030/0.066
				"OFF" (White)	Red	ZB4BL435	0.030/0.066
					Black	ZB4BL235	0.030/0.066

101180

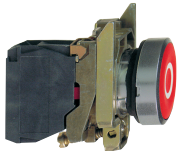

XB4BA4322

101195



ZB4BA331

101196



ZB4BA334

101218





ZB4BL432

Heads with black metal bezel

To order, add a 7 to the references selected from above.
 Example: **ZB4BA331** becomes **ZB4BA3317**.

- (1) For recommended maximum number of contacts constituting the body (fixing collar and contact) associated with the head, see page 24.
 (2) Product supplied with cap not attached, allowing orientation through 360° in 90° steps.

Assembly of other products using:
 Body/contact assemblies: see [page 76](#)
 Combined sub-assemblies: see [page 82](#)
 Accessories: see [page 90](#)

Illuminated pushbuttons with flush push ⁽¹⁾ ⁽²⁾							
Screw clamp terminal connections (Schneider Electric anti-loosening system)							
Shape of head	Description	Type of contact		Supply voltage V	Color of push	Reference	Weight kg/lb
							
		NO	NC				

Complete units - With plain lens

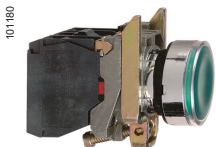

XB4BW33B5

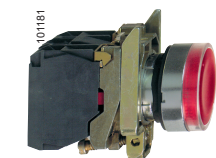

XB4BW34G5

Shape of head	Description	Type of contact	Type of contact	Supply voltage V	Color of push	Reference	Weight kg/lb
	Integral LED	1	1	24 ~ 50/60 Hz	White	XB4BW31B5 (ZB4BW0B15 + ZB4BW313)	0.097/0.214
					Green	XB4BW33B5 (ZB4BW0B35 + ZB4BW333)	0.097/0.214
					Red	XB4BW34B5 (ZB4BW0B45 + ZB4BW343)	0.097/0.214
					Orange	XB4BW35B5 (ZB4BW0B55 + ZB4BW353)	0.097/0.214
					Blue	XB4BW36B5 (ZB4BW0B65 + ZB4BW363)	0.097/0.214
					110...120 ~ 50/60 Hz	White	XB4BW31G5 (ZB4BW0G15 + ZB4BW313)
				Green	XB4BW33G5 (ZB4BW0G35 + ZB4BW333)	0.097/0.214	
				Red	XB4BW34G5 (ZB4BW0G45 + ZB4BW343)	0.097/0.214	
				Orange	XB4BW35G5 (ZB4BW0G55 + ZB4BW353)	0.097/0.214	
				Blue	XB4BW36G5 (ZB4BW0G65 + ZB4BW363)	0.097/0.214	
				230...240 ~ 50/60 Hz	White	XB4BW31M5 (ZB4BW0M15 + ZB4BW313)	0.097/0.214
					Green	XB4BW33M5 (ZB4BW0M35 + ZB4BW333)	0.097/0.214
Red	XB4BW34M5 (ZB4BW0M45 + ZB4BW343)	0.097/0.214					
Orange	XB4BW35M5 (ZB4BW0M55 + ZB4BW353)	0.097/0.214					
Blue	XB4BW36M5 (ZB4BW0M65 + ZB4BW363)	0.097/0.214					

(1) For recommended maximum number of contacts constituting the body (fixing collar and contact) associated with the head, see [page 24](#).

(2) To add customized markings on these references using the web customization tool, see [page 5](#).

Assembly of other products using:
 Combined sub-assemblies: see [page 82](#)
 Accessories: see [page 90](#)

Control and signaling units

Harmony XB4, metal

Illuminated pushbuttons, spring return, with integral LED

Illuminated pushbuttons with flush push (1)

Shape of head	Type of push	Color	Reference	Weight kg/lb	
Heads only (2) - With plain lens					
 101244 ZB4BW333		Flush (3)	White	ZB4BW313	0.026/0.057
			Green	ZB4BW333	0.026/0.057
			Red	ZB4BW343	0.026/0.057
			Orange	ZB4BW353	0.026/0.057
			Yellow	ZB4BW383	0.026/0.057
			Blue	ZB4BW363	0.026/0.057
 XB4_632_CP5CT16035A ZB4BW983		Flush with illuminated ring	White	ZB4BW913	0.026/0.057
			Green	ZB4BW933	0.026/0.057
			Red	ZB4BW943	0.026/0.057
			Orange	ZB4BW953	0.026/0.057
			Yellow	ZB4BW983	0.026/0.057
			Blue	ZB4BW963	0.026/0.057
 PG116073 ZB4BW563		Flush with clear boot (IP69K) (3)	White	ZB4BW513	0.031/0.068
			Green	ZB4BW533	0.031/0.068
			Red	ZB4BW543	0.031/0.068
			Orange	ZB4BW553	0.031/0.068
			Yellow	ZB4BW583	0.031/0.068
			Blue	ZB4BW563	0.031/0.068
 XB4_632_CP5CT17114B ZB4BA98		Flush for insertion of legend (4) (IP69K)	White	ZB4BA18	0.028/0.062
			Green	ZB4BA38	0.028/0.062
			Red	ZB4BA48	0.028/0.062
			Orange	ZB4BA58	0.028/0.062
			Yellow	ZB4BA88 (3)	0.028/0.062
			Blue	ZB4BA68	0.028/0.062
	Illuminated flush pushbutton head, with set of 6 colored caps	White, green, red, orange, yellow, and blue	ZB4BA98	0.022/0.049	
Heads only (2) - With grooved lens (5) (3)					
		Flush	White	ZB4BW313S	0.026/0.057
			Green	ZB4BW333S	0.026/0.057
			Red	ZB4BW343S	0.026/0.057
			Orange	ZB4BW353S	0.026/0.057
			Yellow	ZB4BW383S	0.026/0.057
			Blue	ZB4BW363S	0.026/0.057

(1) For recommended maximum number of contacts constituting the body (fixing collar and contact) associated with the head, see [page 24](#).

(2) For use with bodies comprising a light source with integral LED only.

(3) To add customized markings on these references using the web customization tool, see [page 5](#).

(4) For legend ordering information, see [page 100](#).

(5) For use in bright ambient light conditions (for example, outdoors in sunlight).

Assembly of other products using:
 Combined sub-assemblies: see [page 82](#)
 Accessories: see [page 90](#)

Control and signaling units

Harmony XB4, metal

Illuminated pushbuttons, spring return, with integral LED



Illuminated pushbuttons with projecting push ⁽¹⁾				
Shape of head	Type of push	Color	Reference	Weight kg/lb
Heads only (2) - With plain lens (3)				
	Projecting	White	ZB4BW113	0.029/0.064
		Green	ZB4BW133	0.029/0.064
		Red	ZB4BW143	0.029/0.064
		Orange	ZB4BW153	0.029/0.064
		Yellow	ZB4BW183	0.029/0.064
		Blue	ZB4BW163	0.029/0.064

Heads only (2) - With grooved lens (4)				
	Projecting	White	ZB4BW113S (3)	0.026/0.057
		Green	ZB4BW133S (3)	0.026/0.057
		Red	ZB4BW143S (3)	0.026/0.057
		Orange	ZB4BW153S	0.026/0.057
		Yellow	ZB4BW183S (3)	0.026/0.057
		Blue	ZB4BW163S (3)	0.026/0.057

Heads with black metal bezel

To order, add a 7 to the references selected from above.

Example 1: **ZB4BW113** becomes **ZB4BW1137**.

Example 2: **ZB4BW113S** becomes **ZB4BW113S7**.

(1) For recommended maximum number of contacts constituting the body (fixing collar and contact) associated with the head, see [page 24](#).

(2) For use with bodies comprising a light source with integral LED only.

(3) To add customized markings on these references using the web customization tool, see [page 5](#).

(4) For use in bright ambient light conditions (for example, outdoors in sunlight).

Control and signaling units

Harmony XB4, metal
 Illuminated pushbuttons, spring return,
 with BA 9s base fitting

Illuminated pushbuttons with flush push ⁽¹⁾							
Screw clamp terminal connections (Schneider Electric anti-loosening system)							
Shape of head	Description	Type of contact		Supply voltage V	Color of push	Reference	Weight kg/lb
		NO	NC				

Complete units - With plain lens

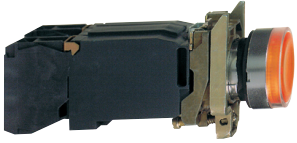
	Direct supply for bulb with BA 9s base fitting, 2.4 W max (bulb not included)	1	1	≤ 250	White	XB4BW3165 (ZB4BW065 + ZB4BW31)	0.097/0.214	
					Green	XB4BW3365 (ZB4BW065 + ZB4BW33)	0.097/0.214	
					Red	XB4BW3465 (ZB4BW065 + ZB4BW34)	0.097/0.214	
					Orange	XB4BW3565 (ZB4BW065 + ZB4BW35)	0.097/0.214	
	Via integral transformer 1.2 VA, 6 V secondary, incandescent bulb with BA 9s base fitting (bulb included)	1	1	110...120 ~ 50/60 Hz	White	XB4BW3135 (ZB4BW035 + ZB4BW31)	0.169/0.373	
					Green	XB4BW3335 (ZB4BW035 + ZB4BW33)	0.169/0.373	
					Red	XB4BW3435 (ZB4BW035 + ZB4BW34)	0.169/0.373	
					Orange	XB4BW3535 (ZB4BW035 + ZB4BW35)	0.169/0.373	
		230 ~ 50 Hz 220...240 ~ 60 Hz	1	1	230 ~ 50 Hz 220...240 ~ 60 Hz	White	XB4BW3145 (ZB4BW045 + ZB4BW31)	0.170/0.375
						Green	XB4BW3345 (ZB4BW045 + ZB4BW33)	0.170/0.375
						Red	XB4BW3445 (ZB4BW045 + ZB4BW34)	0.170/0.375
						Orange	XB4BW3545 (ZB4BW045 + ZB4BW35)	0.170/0.375

Heads only ⁽²⁾ - With plain lens

	Flush	White	ZB4BW31	0.027/0.060
		Green	ZB4BW33	0.027/0.060
		Red	ZB4BW34	0.027/0.060
		Orange	ZB4BW35	0.027/0.060
		Blue	ZB4BW36	0.027/0.060
		Clear	ZB4BW37	0.027/0.060

Heads only ⁽²⁾ - With grooved lens ⁽³⁾

	Flush	White	ZB4BW31S	0.027/0.060
		Green	ZB4BW33S	0.027/0.060
		Red	ZB4BW34S	0.027/0.060
		Orange	ZB4BW35S	0.027/0.060
		Blue	ZB4BW36S	0.027/0.060
		Clear	ZB4BW37S	0.027/0.060

Illuminated pushbuttons with projecting push ⁽¹⁾

Heads only ⁽²⁾ - With plain lens

	Projecting	White	ZB4BW11	0.028/0.062
		Green	ZB4BW13	0.028/0.062
		Red	ZB4BW14	0.028/0.062
		Orange	ZB4BW15	0.028/0.062
		Blue	ZB4BW16	0.028/0.062
		Clear	ZB4BW17	0.028/0.062

Heads only ⁽²⁾ - With grooved lens ⁽³⁾

	Projecting	White	ZB4BW11S	0.027/0.060
		Green	ZB4BW13S	0.027/0.060
		Red	ZB4BW14S	0.027/0.060
		Orange	ZB4BW15S	0.027/0.060
		Blue	ZB4BW16S	0.027/0.060
		Clear	ZB4BW17S	0.027/0.060

Heads with black metal bezel

To order, add a 7 to the references selected from above.
 Example 1: **ZB4BW31** becomes **ZB4BW317**. Example 2: **ZB4BW31S** becomes **ZB4BW31S7**.

(1) For recommended maximum number of contacts constituting the body (fixing collar and contact) associated with the head, see [page 24](#).

(2) For use with bodies comprising a light source with BA9s base fitting bulb (incandescent, neon, or LED) only.







(3) For use in bright ambient light conditions (for example, outdoors in sunlight).

Assembly of other products using:
 Body/contact assemblies: see [page 76](#)
 Accessories: see [page 90](#)

Control and signaling units

Harmony XB4, metal

Flush mounted spring return pushbuttons, unmarked

Flush mounted pushbuttons with flush push for Ø 30 mm ⁽¹⁾ ⁽²⁾												
Screw clamp terminal connections (Schneider Electric anti-loosening system)												
Shape of head	Type of push	Type of contact		Marking on bezel Text (color)	Color of push	Reference	Weight kg/lb					
		NO	NC									
Complete units												
	Flush	1	-		White	XB4FA11 (ZB4BZ101 + ZB4FA1)	0.080/0.176					
					Black	XB4FA21 (ZB4BZ101 + ZB4FA2)	0.080/0.176					
					Green	XB4FA31 (ZB4BZ101 + ZB4FA3)	0.080/0.176					
					Yellow	XB4FA51 (ZB4BZ101 + ZB4FA5)	0.080/0.176					
					Blue	XB4FA61 (ZB4BZ101 + ZB4FA6)	0.080/0.176					
					Red	XB4FA42 (ZB4BZ102 + ZB4FA4)	0.080/0.176					
					-	1						
Heads only												
	Without cap ⁽³⁾				-	ZB4FA0	0.028/0.062					
	Flush, with set of 6 colored caps				6 colors ⁽⁴⁾	ZB4FA9	0.038/0.084					
	Flush				White	ZB4FA1	0.029/0.064					
					Black	ZB4FA2	0.029/0.064					
					Green	ZB4FA3	0.029/0.064					
					Red	ZB4FA4	0.029/0.064					
					Yellow	ZB4FA5	0.029/0.064					
					Blue	ZB4FA6	0.029/0.064					
					Gray	ZB4FA8	0.029/0.064					
					White	ZB4FA18	0.028/0.062					
					Green	ZB4FA38	0.028/0.062					
					Red	ZB4FA48	0.028/0.062					
	Flush with transparent cap for insertion of legend ⁽⁵⁾				Yellow	ZB4FA58	0.028/0.062					
					Blue	ZB4FA68	0.028/0.062					
					Heads only with marked bezel							
						Flush			"START" (Black)	Green	ZB4FA3M33	0.029/0.064
					Pushbuttons with recessed push ⁽¹⁾							
High guard												
Shape of head	Type of push			Color	Reference	Weight kg/lb						
Heads only												
	Recessed (high guard)					White	ZB4FA16 ⁽²⁾	0.034/0.075				
						Black	ZB4FA26 ⁽²⁾	0.034/0.075				
						Green	ZB4FA36 ⁽²⁾	0.034/0.075				
						Red	ZB4FA46 ⁽²⁾	0.034/0.075				
						Yellow	ZB4FA56	0.034/0.075				
						Blue	ZB4FA66	0.034/0.075				

(1) For recommended maximum number of contacts constituting the body (fixing collar and contact) associated with the head, see [page 24](#).

(2) To add customized markings on these references using the web customization tool, see [page 5](#).

(3) Colored cap to be ordered separately: see [page 90](#).

(4) Head supplied with 6 different colored caps (white, black, green, red, yellow, and blue) not fitted.

(5) For legend ordering information, see [page 100](#).

Assembly of other products using:
 Body/contact assemblies: see [page 76](#)
 Accessories: see [page 90](#)



Control and signaling units

Harmony XB4, metal

Flush mounted spring return pushbuttons, unmarked

Flush mounted pushbuttons with projecting push for Ø 30 mm ^{(1) (2)}

Screw clamp terminal connections (Schneider Electric anti-loosening system)

Shape of head	Type of push	Type of contact	Marking on bezel Text (color)	Color of push	Reference	Weight kg/lb
		 NO  NC				

Complete units

	Projecting	–	1	–	Red	XB4FL42 (ZB4BZ102 + ZB4FL4)	0.081/0.179
---	------------	---	---	---	-----	---------------------------------------	-------------

Heads only

	Projecting				White	ZB4FL1	0.030/0.066
					Black	ZB4FL2	0.030/0.066
					Green	ZB4FL3	0.030/0.066
					Red	ZB4FL4	0.030/0.066
					Yellow	ZB4FL5	0.030/0.066
					Blue	ZB4FL6	0.030/0.066

Heads only with marked bezel

	Projecting			"STOP" (Black)	Red	ZB4FL4M34	0.030/0.066
---	------------	--	--	----------------	-----	------------------	-------------

(1) For recommended maximum number of contacts constituting the body (fixing collar and contact) associated with the head, see [page 24](#).

(2) To add customized markings on these references using the web customization tool, see [page 5](#).



XB4FL42



ZB4FL1

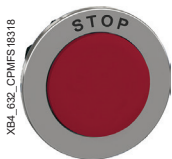

ZB4FL4M34

Assembly of other products using:
Body/contact assemblies: see page 76
Accessories: see page 90

Control and signaling units

Harmony XB4, metal

Flush mounted spring return pushbuttons, with marking

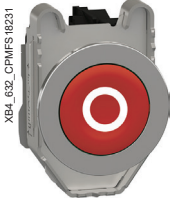

XB4FA4322

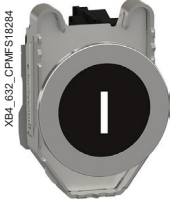

ZB4FA331

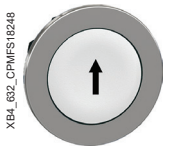

ZB4FA334



ZB4FL432

Flush mounted pushbuttons with flush or projecting push for Ø 30 mm ⁽¹⁾							
Screw clamp terminal connections (Schneider Electric anti-loosening system)							
Shape of head	Type of push	Type of contact		Marking Text (color)	Color of push	Reference	Weight kg/lb
		N/O	N/C				
Complete units ⁽²⁾							
	Flush	1	–	"I" (White)	Green	XB4FA3311 (ZB4BZ101 + ZB4FA331)	0.080/0.176
	Flush	–	1	"O" (White)	Red	XB4FA4322 (ZB4BZ102 + ZB4FA432)	0.080/0.176
	Projecting	1	1	"O" (White)	Red	XB4FL4325 (ZB4BZ105 + ZB4FL432)	0.080/0.176
	Flush (3)	1	–	↑ (Black)	White	XB4FA3341 (ZB4BZ101 + ZB4FA334)	0.080/0.176
	Flush (3)	1	–	↓ (White)	Black	XB4FA3351 (ZB4BZ101 + ZB4FA335)	0.080/0.176
Heads only							
	Flush			"I" (White)	Green	ZB4FA331 (2)	0.029/0.064
				"I" (Black)	White	ZB4FA131 (2)	0.029/0.064
				"II" (White)	Green	ZB4FA336	0.029/0.064
				"II" (Black)	White	ZB4FA136	0.029/0.064
				"START" (white)	Green	ZB4FA333 (2)	0.029/0.064
				"START" (Black)	White	ZB4FA133	0.029/0.064
				"ON" (White)	Green	ZB4FA341	0.029/0.064
				"ON" (Black)	White	ZB4FA141	0.029/0.064
				"MARCHE" (White)	Green	ZB4FA342	0.029/0.064
				"MARCHE" (Black)	White	ZB4FA142	0.029/0.064
					Black	ZB4FA245	0.029/0.064
					White	ZB4FA145	0.029/0.064
				"O" (White)	Red	ZB4FA432 (2)	0.029/0.064
					Black	ZB4FA232 (2)	0.029/0.064
				"ARRET" (White)	Red	ZB4FA433	0.029/0.064
					Black	ZB4FA233	0.029/0.064
				"STOP" (White)	Red	ZB4FA434 (2)	0.029/0.064
					Black	ZB4FA234	0.029/0.064
				"OFF" (White)	Red	ZB4FA435	0.029/0.064
					Black	ZB4FA235	0.029/0.064
			↑ (Black) (3)	White	ZB4FA334 (2)	0.029/0.064	
			↓ (White) (3)	Black	ZB4FA335 (2)	0.029/0.064	
	Projecting			"O" (White)	Red	ZB4FL432 (2)	0.030/0.066
					Black	ZB4FL232 (2)	0.030/0.066
				"ARRET" (White)	Red	ZB4FL433	0.030/0.066
					Black	ZB4FL233	0.030/0.066
				"STOP" (White)	Red	ZB4FL434 (2)	0.030/0.066
					Black	ZB4FL234	0.030/0.066
				"OFF" (White)	Red	ZB4FL435	0.030/0.066
					Black	ZB4FL235	0.030/0.066

(1) For recommended maximum number of contacts constituting the body (fixing collar and contact) associated with the head, see page 24.

(2) To add customized markings on these references using the web customization tool, see page 5.

(3) Product supplied with cap not attached, allowing orientation through 360° in 90° steps.

References

Assembly of other products using:
 Body/contact assemblies: see [page 76](#)
 Combined sub-assemblies: see [page 82](#)
 Accessories: see [page 90](#)



Control and signaling units

Harmony XB4, metal

Flush mounted illuminated pushbuttons, spring return,
 with integral LED

Flush mounted illuminated pushbuttons with flush push for Ø 30 mm ⁽¹⁾ ⁽²⁾

Screw clamp terminal connections (Schneider Electric anti-loosening system)

Shape of head	Description	Type of contact		Supply voltage V	Color of push	Reference	Weight kg/lb
							
Complete units - With plain lens							
 Protected LED	Integral LED	1	1	24 ~ 50/60 Hz	White	XB4FW31B5 (ZB4BW0B15 + ZB4FW313)	0.097/0.214
					Green	XB4FW33B5 (ZB4BW0B35 + ZB4FW333)	0.097/0.214
					Red	XB4FW34B5 (ZB4BW0B45 + ZB4FW343)	0.097/0.214
					Orange	XB4FW35B5 (ZB4BW0B55 + ZB4FW353)	0.097/0.214
					Blue	XB4FW36B5 (ZB4BW0B65 + ZB4FW363)	0.097/0.214
					110...120 ~ 50/60 Hz	White	XB4FW31G5 (ZB4BW0G15 + ZB4FW313)
	Green	XB4FW33G5 (ZB4BW0G35 + ZB4FW333)	0.097/0.214				
	Red	XB4FW34G5 (ZB4BW0G45 + ZB4FW343)	0.097/0.214				
	Orange	XB4FW35G5 (ZB4BW0G55 + ZB4FW353)	0.097/0.214				
	Blue	XB4FW36G5 (ZB4BW0G65 + ZB4FW363)	0.097/0.214				
	230...240 ~ 50/60 Hz	White	XB4FW31M5 (ZB4BW0M15 + ZB4FW313)	0.097/0.214			
	Green	XB4FW33M5 (ZB4BW0M35 + ZB4FW333)	0.097/0.214				
	Red	XB4FW34M5 (ZB4BW0M45 + ZB4FW343)	0.097/0.214				
	Orange	XB4FW35M5 (ZB4BW0M55 + ZB4FW353)	0.097/0.214				
	Blue	XB4FW36M5 (ZB4BW0M65 + ZB4FW363)	0.097/0.214				

(1) For recommended maximum number of contacts constituting the body (fixing collar and contact) associated with the head, see [page 24](#).

(2) To add customized markings on these references using the web customization tool, see [page 5](#).

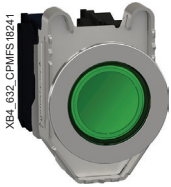

XB4FW33B5



XB4FW34G5



Assembly of other products using:
 Combined sub-assemblies: see [page 82](#)
 Accessories: see [page 90](#)

Control and signaling units

Harmony XB4, metal

Flush mounted illuminated pushbuttons, spring return,
 with integral LED

Flush mounted illuminated pushbuttons with flush push for Ø 30 mm ⁽¹⁾

Shape of head	Type of push	Color	Reference	Weight kg/lb		
Heads only ⁽²⁾ - With plain lens						
 ZB4FW333  ZB4FW983		Flush ⁽³⁾	White	ZB4FW313	0.026/0.057	
			Green	ZB4FW333	0.026/0.057	
			Red	ZB4FW343	0.026/0.057	
			Orange	ZB4FW353	0.026/0.057	
			Blue	ZB4FW363	0.026/0.057	
			Yellow	ZB4FW383	0.026/0.057	
			Flush with illuminated ring	White	ZB4FW913	0.026/0.057
				Green	ZB4FW933	0.026/0.057
				Red	ZB4FW943	0.026/0.057
		Orange		ZB4FW953	0.026/0.057	
		Blue		ZB4FW963	0.026/0.057	
		Yellow		ZB4FW983	0.026/0.057	
		Flush for insertion of legend ⁽⁴⁾ ⁽³⁾ (IP69K)	White	ZB4FA18	0.028/0.062	
			Green	ZB4FA38	0.028/0.062	
			Red	ZB4FA48	0.028/0.062	
Orange	ZB4FA58		0.028/0.062			
Blue	ZB4FA68		0.028/0.062			
Yellow	ZB4FA88		0.028/0.062			

(1) For recommended maximum number of contacts constituting the body (fixing collar and contact) associated with the head, see [page 24](#).

(2) For use with bodies comprising a light source with integral LED only.

(3) To add customized markings on these references using the web customization tool, see [page 5](#).

(4) For legend ordering information, see [page 100](#).

References

Assembly of other products using:
 Combined sub-assemblies: see [page 82](#)
 Accessories: see [page 90](#)

Control and signaling units

Harmony XB4, metal

Flush mounted illuminated pushbuttons, spring return,
 with integral LED

XB4_632_CPMFS18263



ZB4FW113



Flush mounted illuminated pushbuttons with projecting push for Ø 30 mm ^{(1) (2)}				
Shape of head	Type of push	Color	Reference	Weight kg/lb
Heads only (3) - With plain lens				
	Projecting	White	ZB4FW113	0.029/0.064
		Green	ZB4FW133	0.029/0.064
		Red	ZB4FW143	0.029/0.064
		Orange	ZB4FW153	0.029/0.064
		Blue	ZB4FW163	0.029/0.064
		Yellow	ZB4FW183	0.029/0.064

(1) For recommended maximum number of contacts constituting the body (fixing collar and contact) associated with the head, see [page 24](#).

(2) To add customized markings on these references using the web customization tool, see [page 5](#).

(3) For use with bodies comprising a light source with integral LED only.

User assembly of other units, using:
 Body-contact assemblies: see page 76
 Combined sub-assemblies: see page 82

Control and signaling units

Harmony XB4 metal

Multiple-headed pushbuttons, spring return



XB4BL73415



ZB4BA7121



ZB4BL7341



XB4BW73731●5



ZB4BW7A1721



ZB4BW7A3741

Double-headed pushbuttons ⁽¹⁾						
Screw clamp terminal connections (Schneider Electric anti-loosening system)						
Shape of head	Description	Type of contact		Color and marking of caps ⁽²⁾	Reference	Weight kg/lb
		NO	NC			

Complete units						
	2 pushes (1 flush Black + 1 projecting Red)	1	1	White "I" on Green background White "0" on Red background	XB4BL73415	0.116/0.256

Heads only						
	2 flush Black pushes			White and Black background, unmarked	ZB4BA7120	0.056/0.123
				Black "I" on White background White "0" on Black background	ZB4BA7121	0.056/0.123
				Green and Red background, unmarked	ZB4BA7340	0.056/0.123
				White "I" on Green background White "0" on Red background	ZB4BA7341	0.056/0.123
				Without cap ⁽³⁾	ZB4BA79	0.056/0.123

	1 flush Black push 1 projecting Red push			Green and Red background, unmarked	ZB4BL7340	0.056/0.123
				White "I" on Green background White "0" on Red background	ZB4BL7341	0.056/0.123

Double-headed pushbuttons + 1 white central pilot light block ⁽¹⁾							
Screw clamp terminal connections (Schneider Electric anti-loosening system)							
Shape of head	Description	Type of contact		Color and marking of caps ⁽²⁾	Pilot light voltage V	Reference	Weight kg/lb
		NO	NC				

Complete units							
	1 flush Black push 1 projecting Red push 1 White central pilot light block	1	1	White "I" on Green background White "0" on Red background	24	XB4BW73731B5	0.130/0.287
					120	XB4BW73731G5	0.130/0.287
					240	XB4BW73731M5	0.130/0.287

Heads only ⁽⁵⁾							
	2 flush Black pushes 1 clear central pilot light ⁽⁴⁾			White and Black background, unmarked		ZB4BW7A1720	0.056/0.123
				Black "I" on White background White "0" on Black background		ZB4BW7A1721	0.056/0.123
				Green and Red background, unmarked		ZB4BW7A3740	0.056/0.123
				White "I" on Green background White "0" on Red background		ZB4BW7A3741	0.056/0.123
				Black "I" on White background White "0" on Black background		ZB4BW7A1724	0.056/0.123
				Black "+" on White background Black "-" on White background		ZB4BW7A1715	0.056/0.123
				Without cap ⁽³⁾		ZB4BW7A9	0.056/0.123

	1 flush Black push 1 projecting Red push 1 clear central pilot light ⁽⁴⁾			Green and Red background, unmarked		ZB4BW7L3740	0.056/0.123
				White "I" on Green background White "0" on Red background		ZB4BW7L3741	0.056/0.123

Heads with black metal bezel

To order, add the suffix 7 to the references selected above. Example: **ZB4BA7120** becomes **ZB4BA71207**.

- (1) Recommended maximum number of contacts constituting the body (fixing collar and contact) associated with the head, see page 24.
- (2) These caps are fitted by Schneider Electric and cannot be removed (risk of damage).
- (3) Caps to be ordered separately; see page opposite.
- (4) Color of centrally positioned pilot light determined by the color of the LED incorporated in the body sub-assembly.
- (5) Only for use with bodies comprising a light source with integral LED.

User assembly of other units, using:
 Body-contact assemblies: see [page 76](#)
 Combined sub-assemblies: see [page 82](#)



Control and signaling units

Harmony XB4 metal

Multiple-headed pushbuttons, spring return

Triple-headed pushbuttons (1) (2)

Screw clamp terminal connections (Schneider Electric anti-loosening system)

Shape of head	Description	Type of contact	Color and marking of caps (3)	Reference	Weight kg/lb
		 NO  NC  NO			

Complete units

	2 flush Black pushes + 1 central projecting Red push marked "Stop" in White	1	1	1	White "I" on Green background White "II" on Green background	XB4BA731327	0.128/0.282
					Black "→" on White background White "←" on Black background	XB4BA711237	0.128/0.282

Heads only

	2 flush Black pushes + 1 central projecting Red push marked "Stop" in White				White "I" on Green background White "II" on Green background	ZB4BA73132	0.056/0.123
					White "←" on Green background White "→" on Green background	ZB4BA73133	0.056/0.123
					White "↑" on Green background White "↓" on Green background	ZB4BA73134	0.056/0.123
					White "+" on Green background White "-" on Green background	ZB4BA73135	0.056/0.123
					Black "+" on White background Black "-" on White background	ZB4BA71115	0.056/0.123
					Black "→" on White background White "←" on black background	ZB4BA71123	0.056/0.123
					Black "↑" on White background White "↓" on Black background	ZB4BA71124	0.056/0.123
					White "↑" on Black background White "↓" on Black background	ZB4BA72124	0.056/0.123
					Without cap (4)	ZB4BA791	0.056/0.123

Specific accessories for multiple-headed pushbuttons

Description	Background color	Marking	Sold in lots of	Reference	Weight kg/lb	
Caps only for clip-on mounting (5) on: - ZB4BA791 double-headed pushbuttons - ZB4BW7A9 double-headed pushbuttons + central pilot light block - ZB4BA791 triple-headed pushbuttons	White	Unmarked	10	ZBA71	0.010/0.022	
		"I" Black	10	ZBA7131	0.010/0.022	
		"→" Black	10	ZBA7134	0.010/0.022	
		"+" Black	10	ZBA7138	0.010/0.022	
	Black	Unmarked	10	ZBA72	0.010/0.022	
		"O" White	10	ZBA7232	0.010/0.022	
		"+" White	10	ZBA7233	0.010/0.022	
		"→" White	10	ZBA7235	0.010/0.022	
			"I" White	10	ZBA7237	0.010/0.022
	Green	Unmarked	10	ZBA73	0.010/0.022	
		"I" White	10	ZBA7331	0.010/0.022	
		"+" White	10	ZBA7333	0.010/0.022	
"↑" White		10	ZBA7335	0.010/0.022		
		"II" White	10	ZBA7336	0.010/0.022	
Red	Unmarked	10	ZBA74	0.010/0.022		
	"O" White	10	ZBA7432	0.010/0.022		
Yellow	Unmarked	10	ZBA75	0.010/0.022		
	Unmarked	10	ZBA76	0.010/0.022		

Clear silicone boots (6)	For 2 flush pushes	–	10	ZBA708	0.055/0.121
	For 3 pushes	–	10	ZBA709	0.055/0.121
	For 1 flush push + 1 projecting push	–	10	ZBA710	0.055/0.121

Heads with black metal bezel

To order, add the suffix 7 to the references selected above.

Example: **ZB4BA73132** becomes **ZB4BA731327**.

(1) Recommended maximum number of contacts constituting the body (fixing collar and contact) associated with the head, see [page 24](#).

(2) Not compatible with high power switching contacts and contacts for printed circuit board.

(3) These caps are fitted by Schneider Electric and cannot be removed (risk of damage).

(4) Caps to be ordered separately: see accessories on this page.

(5) Can be clipped-in at 90° steps, through 360°.

(6) Can be replaced without dismantling the head.



XB4BA731327



ZB4BA73133



ZB4BA71124



ZBA7235



ZBA7432



ZBA709

Assembly of other products using:
 Body/contact assemblies: see page 76
 Accessories: see page 90

Mushroom head pushbuttons ^{(1) (2)}						
Screw clamp terminal connections (Schneider Electric anti-loosening system)						
Shape of head	Type of push	Type of contact		Push Ø (mm)/in.	Color	Reference
		NO	NC			

Complete units						
	Mushroom head	1	–	40/1.575	Black	XB4BC21 (ZB4BZ101 + ZB4BC2)
						0.122/0.269

Heads only						
	Mushroom head			30/1.181	Black	ZB4BC24
					Green	ZB4BC34
					Red	ZB4BC44
					Yellow	ZB4BC54
					Blue	ZB4BC64
						0.075/0.165
				40/1.575	Black	ZB4BC2
					Green	ZB4BC3
					Red	ZB4BC4
					Yellow	ZB4BC5
					Blue	ZB4BC6
						0.074/0.163
				60/2.362	Black	ZB4BR2
					Green	ZB4BR3
					Red	ZB4BR4
					Yellow	ZB4BR5
					Blue	ZB4BR6
						0.093/0.205
				60/2.362 (3)	Black	ZB4BR216
				Hemispherical	Green	ZB4BR316
					Red	ZB4BR416
					Yellow	ZB4BR516
					Blue	ZB4BR616
						0.054/0.119

Illuminated mushroom head pushbuttons ^{(1) (2)}

Integral LED						
Shape of head	Type of push	Push Ø (mm)/in.	Color	Reference	Weight kg/lb	
	Mushroom head	40/1.575	White	ZB4BW413	0.051/0.112	
			Green	ZB4BW433	0.051/0.112	
			Red	ZB4BW443	0.051/0.112	
			Orange	ZB4BW453	0.051/0.112	
			Blue	ZB4BW463	0.051/0.112	

Heads with black metal bezel

To order, add a figure 7 to the references selected above.
 Example: **ZB4BC24** becomes **ZB4BC247**.



- (1) These pushbuttons and heads cannot be used for an Emergency Stop function. Therefore, it is recommended that a legend with a Black or White background is used.
- (2) Recommended maximum number of contacts constituting the body (fixing collar and contact) associated with the head, see page 24.
- (3) Ergonomic product used in two-handed control applications. Recommended maximum number of contacts constituting the body (fixing collar and contact) associated with the head: 6.
- (4) Only for use with bodies comprising a light block with integral LED.

Assembly of other products using:
 Body/contact assemblies: see page 76
 Accessories: see page 90

Control and signaling units

Harmony XB4, metal
 Mushroom head pushbuttons, latching
 Bellows for harsh environment

Mushroom head pushbuttons (1)(2)

Shape of head	Type of reset	Push Ø (mm)/in.	Color	Reference	Weight kg/lb
Heads only					
	Push-pull	40/1.575	Black	ZB4BT2 (6)	0.077/0.170
		60/2.362	Black	ZB4BX2	0.095/0.209
	Turn to release	30/1.181	Black	ZB4BS42	0.066/0.146
		40/1.575	Black	ZB4BS52	0.070/0.154
		40/1.575	Yellow	ZB4BS55	0.070/0.154
		60/2.362	Black	ZB4BS62	0.090/0.198
	Key release (key no. 455) (2 keys included with head) (3) (4)	30/1.181	Black	ZB4BS72	0.066/0.146
		40/1.575	Black	ZB4BS12 (5)	0.070/0.154
		60/2.362	Black	ZB4BS22	0.090/0.198

110130



ZB4BT2

PG113908



ZB4BS62

110136



ZB4BS72

Illuminated mushroom head pushbuttons (1) (2)

Integral LED					
Shape of head	Type of reset	Push Ø (mm)/in.	Color	Reference	Weight kg/lb
Heads only					
	Mushroom head	40/1.575	White	ZB4BW613	0.051/0.112
			Green	ZB4BW633	0.051/0.112
			Orange	ZB4BW653	0.051/0.112
			Blue	ZB4BW663	0.051/0.112

XB4_632_CP00A2016012



ZB4BW653

107361



ZBZ48

Bellows for harsh environment (IP 69K)

For use in	Material	Color	Sold in lots of	Reference	Weight kg/lb
Environment subject to humidity, dust, high pressure cleaning, etc.	Silicone	Red	2	ZBZ48	0.009/0.020

Heads with black metal bezel

To order, add a figure 7 to the references selected above.
 Example: ZB4BT2 becomes ZB4BT27.

- (1) These pushbuttons and heads cannot be used for an Emergency Stop function. Therefore, it is recommended that a legend with a Black or White background is used.
- (2) Recommended maximum number of contacts constituting the body (fixing collar and contact) associated with the head, see page 24.
- (3) For specific keys with other numbers, please contact our Customer Care Center.
- (4) The symbol  indicates key withdrawal position(s).
- (5) Other key numbers:
 - key no. 421E: add suffix 12 to the reference.
 - key no. 458A: add suffix 10 to the reference.
 - key no. 520E: add suffix 14 to the reference.
 - key no. 3131A: add suffix 20 to the reference.
 Example: To order a Ø 40/1.575 in. Black mushroom head for a latching pushbutton, with release by key no. 421E, the reference becomes: ZB4BS1212.
- (6) To order a yellow head pushbutton, replace the last digit of the commercial reference with a 5, example: ZB4BT2 becomes ZB4BT5 and to order a blue head replace with a 6, example: ZB4BT2 becomes ZB4BT6.

Assembly of other products using:
Body/contact assemblies: see page 76
Accessories: see page 99 and 106

Emergency stop and Emergency switching off functions conforming to EN/IEC 60204-1, 60364-5-53, EN/ISO 13850 and Machinery Directive 2006/42/EC





Emergency stop function: Mushroom head Emergency stop trigger action and mechanical latching pushbuttons conform to standards EN/IEC 60204-1 and EN/ISO 13850, Machinery Directive 2006/42/EC, and to standard EN/IEC 60947-5-5.

Emergency switching off function: Mushroom head switching off mechanical latching pushbuttons conform to standards IEC 60364-5-53 and EN/IEC 60947-5-5.

Please contact our Customer Care Center for a detailed explanation of these standards and directives.

Emergency stop and switching off pushbuttons with trigger action and mechanical latching ^{(1) (2)}

Screw clamp terminal connections (Schneider Electric anti-loosening system)

Shape of head	Type of reset	Type of contact		Push Ø (mm)/in.	Color	Reference	Weight kg/lb
							
Complete units							
	Push-pull	–	1	40/1.575	Red	XB4BT842 (ZB4BZ105 + ZB4BT84)	0.125/0.276
		1	1	40/1.575	Red	XB4BT845 (ZB4BZ105 + ZB4BT84)	0.136/0.300
	Turn to release	–	1	40/1.575	Red	XB4BS8442 (ZB4BZ102 + ZB4BS844)	0.118/0.260
		1	1	40/1.575	Red	XB4BS8445 (ZB4BZ105 + ZB4BS844)	0.130/0.287
		–	2	40/1.575	Red	XB4BS8444 (ZB4BZ104 + ZB4BS844)	0.130/0.287
	Key release (key no. 455) ⁽³⁾	1	1	40/1.575	Red	XB4BS9445 (ZB4BZ105 + ZB4BS944)	0.170/0.375

(1) For recommended maximum number of contacts constituting the body (fixing collar + contact) associated with the head, see page 24.

(2) It is recommended that a legend or yellow background is used.

(3) The symbol  indicates key withdrawal position(s).

PF512504

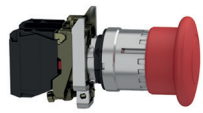

XB4BT845

PF512505

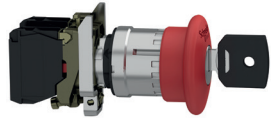

XB4BS9445

Assembly of other products using:
 Body/contact assemblies: see [page 76](#)
 Accessories: see [page 103](#) and [106](#)

Emergency stop and Emergency switching off functions conforming to EN/IEC 60204-1, 60364-5-53, EN/ISO 13850 and Machinery Directive 2006/42/EC

Emergency stop function: Mushroom head Emergency stop trigger action and mechanical latching pushbuttons conform to standards EN/IEC 60204-1 and EN/ISO 13850, Machinery Directive 2006/42/EC, and to standard EN/IEC 60947-5-5.



Emergency switching off function: Mushroom head switching off mechanical latching pushbuttons conform to standards IEC 60364-5-53 and EN/IEC 60947-5-5.

Please contact our Customer Care Center for a detailed explanation of these standards and directives.

Emergency stop and switching off pushbuttons with trigger action and mechanical latching (1) (2)

Screw clamp terminal connections (Schneider Electric anti-loosening system)

Heads only

Shape of head	Type of reset	Push		Reference	Weight kg/lb
		Ø (mm)/in.	Color		
	Push-pull	30/1.181	Red	ZB4BT844	0.078/0.172
		40/1.575	Red	ZB4BT84	0.078/0.172
		60/2.362	Red	ZB4BX84	0.098/0.216
	Turn to release	30/1.181	Red	ZB4BS834	0.068/0.150
		40/1.575	Red	ZB4BS844	0.073/0.161
		60/2.362	Red	ZB4BS864	0.093/0.205
	Key release (key no. 455) 2 keys included with head (3) (4)	30/1.181	Red	ZB4BS934	0.094/0.207
		40/1.575	Red	ZB4BS944 (5)	0.098/0.216
		60/2.362	Red	ZB4BS964	0.118/0.260

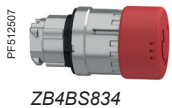
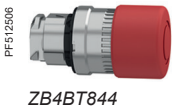

Heads with black metal bezel

To order, add a 7 to the references selected from above.
 Example: **ZB4BT844** becomes **ZB4BT8447**.

- (1) For recommended maximum number of contacts constituting the body (fixing collar + contact) associated with the head, see [page 24](#).
- (2) It is recommended that a legend or yellow background is used.
- (3) The symbol Ω indicates key withdrawal position(s).
- (4) For specific keys with other numbers, please contact our Customer Care Center.
- (5) Other key numbers:
 - Key no. 421E: add suffix **12** to the reference.
 - Key no. 458A: add suffix **10** to the reference.
 - Key no. 520E: add suffix **14** to the reference.
 - Key no. 3131A: add suffix **20** to the reference.
 - Key no. 4A185: add suffix **D** to the reference.
 Example: To order a Ø 40 mm/1.575 in. red mushroom head for a trigger action and mechanical latching Emergency stop pushbutton, with release by key no. 421E, the reference becomes: **ZB4BS94412**.

Control and signaling units

Harmony XB4, metal
Illuminated rings for Emergency stop
Circular yellow legends for Emergency stop

XB4_632_CPMFS18026A



ZBY9W2B330

PF131618A



ZBY9W3B140

PF131618A



ZBY9121

PF131622A



ZBY9420

Illuminated rings for Emergency stop (1)

Description	Marking	Signaling	Supply voltage	Color	Sold in lots of	Reference	Weight kg/lb
Ø 60 mm/2.362 in. illuminated ring for Emergency stop	EMERGENCY STOP	Fixed, red	24 V ~	Yellow	1	ZBY9W2B330	0.031/0.068
	ARRET D'URGENCE	Fixed, red	24 V ~	Yellow	1	ZBY9W2B130	0.031/0.068
	NOT HALT	Fixed, red	24 V ~	Yellow	1	ZBY9W2B230	0.031/0.068
	PARADA DE EMERGENCIA	Fixed, red	24 V ~	Yellow	1	ZBY9W2B430	0.031/0.068
	ARRESTO DI EMERGENZA	Fixed, red	24 V ~	Yellow	1	ZBY9W2B630	0.031/0.068
	-	Fixed, red	24 V ~	Yellow	1	ZBY9W2B140	0.031/0.068
	EMERGENCY STOP	Fixed, red	120 V ~	Yellow	1	ZBY9W2G330	0.031/0.068
	ARRET D'URGENCE	Fixed, red	120 V ~	Yellow	1	ZBY9W2G130	0.031/0.068
	NOT HALT	Fixed, red	120 V ~	Yellow	1	ZBY9W2G230	0.031/0.068
	PARADA DE EMERGENCIA	Fixed, red	120 V ~	Yellow	1	ZBY9W2G430	0.031/0.068
	ARRESTO DI EMERGENZA	Fixed, red	120 V ~	Yellow	1	ZBY9W2G630	0.031/0.068
	-	Fixed, red	120 V ~	Yellow	1	ZBY9W2G140	0.031/0.068
	EMERGENCY STOP	Fixed, red	230 V ~	Yellow	1	ZBY9W2M330	0.031/0.068
	ARRET D'URGENCE	Fixed, red	230 V ~	Yellow	1	ZBY9W2M130	0.031/0.068
	NOT HALT	Fixed, red	230 V ~	Yellow	1	ZBY9W2M230	0.031/0.068
	PARADA DE EMERGENCIA	Fixed, red	230 V ~	Yellow	1	ZBY9W2M430	0.031/0.068
ARRESTO DI EMERGENZA	Fixed, red	230 V ~	Yellow	1	ZBY9W2M630	0.031/0.068	
-	Fixed, red	230 V ~	Yellow	1	ZBY9W2M140	0.031/0.068	
EMERGENCY STOP	Fixed, red + white	24 V ~	Yellow	1	ZBY9W3B330	0.031/0.068	
ARRET D'URGENCE	Fixed, red + white	24 V ~	Yellow	1	ZBY9W3B130	0.031/0.068	
NOT HALT	Fixed, red + white	24 V ~	Yellow	1	ZBY9W3B230	0.031/0.068	
PARADA DE EMERGENCIA	Fixed, red + white	24 V ~	Yellow	1	ZBY9W3B430	0.031/0.068	
ARRESTO DI EMERGENZA	Fixed, red + white	24 V ~	Yellow	1	ZBY9W3B630	0.031/0.068	
-	Fixed, red + white	24 V ~	Yellow	1	ZBY9W3B140	0.031/0.068	

Circular yellow legends for Emergency stop (2)

Description	Marking	Signaling	Supply voltage	Color	Sold in lots of	Reference	Weight kg/lb
Ø 60 mm/2.362 in. - legend for Emergency stop function	-	-	-	Yellow	5	ZBY9121	0.007/0.015
	EMERGENCY STOP	-	-	Yellow	5	ZBY9320	0.007/0.015
	ARRET D'URGENCE	-	-	Yellow	5	ZBY9120	0.007/0.015
	NOT HALT	-	-	Yellow	5	ZBY9220	0.007/0.015
	PARADA DE EMERGENCIA	-	-	Yellow	5	ZBY9420	0.007/0.015
	ARRESTO DI EMERGENZA	-	-	Yellow	5	ZBY9620	0.007/0.015

(1) For compliance with standard EN/ISO 13850, paragraph 4.4.6, the Emergency Stop function logo  has been added.

(2) For other legend models for Emergency stop and Emergency switching off functions, see [page 106](#).

Assembly of other products using:
 Body/contact assemblies: see [page 76](#)
 Accessories: see [page 103](#) and [106](#)

Control and signaling units

Harmony XB4, metal

Illuminated Emergency switching off function

Circular yellow legends for Emergency stop

Bellows for harsh environments

Illuminated Emergency switching off function only, mechanical latching pushbuttons (1)

Screw clamp terminal connections (Schneider Electric anti-loosening system)

Shape of head	Type of reset	Push Ø (mm)/in.	Color	Reference	Weight kg/lb
Heads only (2)					
	Push-pull	40/1.575	Red	ZB4BW643	0.051/0.112



ZB4BW643



Circular yellow legends for ZB4BW643

Diameter mm/in.	Conforming to standards	Marking on yellow background	Sold in lots of	Unit reference	Weight kg/lb
Used for "Emergency switching off" function					
60/2.362	EN/IEC 60204-1	–	10	ZBY9101 (3)	0.004/0.009
		COUPURE D'URGENCE	10	ZBY9160	0.004/0.009
		EMERGENCY SWITCHING OFF	10	ZBY9360	0.004/0.009
		NOT-AUS	10	ZBY9260	0.004/0.009
		DESCONEXION DE EMERGENCIA	10	ZBY9460	0.004/0.009
		INTERRUZIONE DI EMERGENZA	10	ZBY9660	0.004/0.009
90/3.543	EN/IEC 60204-1	–	10	ZBY8101 (3)	0.008/0.018
		COUPURE D'URGENCE	10	ZBY8160	0.008/0.018
		EMERGENCY SWITCHING OFF	10	ZBY8360	0.008/0.018
		NOT-AUS	10	ZBY8260	0.008/0.018
		DESCONEXION DE EMERGENCIA	10	ZBY8460	0.008/0.018
		INTERRUZIONE DI EMERGENZA	10	ZBY8660	0.008/0.018



ZBY9160

Bellows for harsh environments (4)

For use in	Material	For use with	Color	Sold in lots of	Unit reference	Weight kg/lb
Environments subject to humidity, dust, high pressure cleaning, etc.	Silicone	Other functions	Black	2	ZBZ28	0.009/0.020
		Emergency stop/ switching off function	Yellow	2	ZBZ58	0.009/0.020



ZBZ58

(1) For recommended maximum number of contacts constituting the body (fixing collar + contact) associated with the head, see [page 24](#).

(2) For use with bodies comprising a light source with integral LED only.

(3) To add customized markings on these references using the web customization tool, see [page 5](#).

(4) Not compatible with Ø 30 mm/1.181 in. pushbutton.

Assembly of other products using:
body/contact assemblies:
see page 76 and 78



ZB4BC580



ZB4BC28001



Contact + ZB4BC28001



Contact + ZB4BC28001RA

Pushbuttons with integrated bellows

Shape of head	Colour of push	Symbol	Reference	Weight kg/lb
Heads only, Ø 37 mm without marking				
Flush 	White	–	ZB4BC180	0.036/0.079
	Black	–	ZB4BC280	0.036/0.079
	Green	–	ZB4BC380	0.036/0.079
	Red	–	ZB4BC480	0.036/0.079
	Yellow	–	ZB4BC580	0.036/0.079
	Blue	–	ZB4BC680	0.036/0.079
	Gray	–	ZB4BC780	0.036/0.079
	Light blue	–	ZB4BC980	0.036/0.079

Heads only, Ø 37 mm with marking (1)

Flush 	Black	Bell	ZB4BC28001	0.036/0.079
		0	ZB4BC28021	0.036/0.079
	White	I	ZB4BC18023	0.036/0.079
	Red	0	ZB4BC48021	0.036/0.079
	Green	I	ZB4BC38023	0.036/0.079

Other versions

Customization with marking at your choice (texts or symbols)
Rotation of head for horizontal mounting of the contact block (1)
Please contact our Customer Care Centre.

(1) Heads are fixed relative to the position of the contact blocks:

- contact blocks are normally used in the "vertical" position.
 - to mount the contact block in the "horizontal" position, it is necessary to order an alternative head with the symbol rotated by 90°. Please add the suffix "RA" in the end of the references for alternative heads of your choice.
- Example: ZB4BC28001 becomes ZB4BC28001RA.

Assembly of other products using body/contact assemblies: see page 76 and 78



ZBZ1902



ZBZ60

Pushbuttons with integrated bellow (continued)



Accessories

Description	Function	Reference	Weight kg/lb
Protective guard in plastic	Protection against accidental operation	ZBZ1902 (1)	0.010/0.022
Boot for contact block ZBE10●, ZBE10●3 and ZBE50● (2)	Protection against liquid and dust ingress	ZBZ60	0.098/ 0.216

(1) For heads with the "RA" suffix (ZB4BC●●●RA) used with a guard, it is necessary to order the dedicated guard ZBZ1902RA.

(2) Restriction for use: refer to the product instruction sheet on www.schneider-electric.com.

Assembly of other products using:
Body/contact assemblies: see [page 76](#)
Accessories: see [page 90](#)

Pushbuttons with flush push ⁽¹⁾				
Shape of head	Type of push	Color of push	Reference	Weight kg/lb
Heads only				
	Without cap ⁽²⁾	–	ZB4BH0	0.028/0.062
	Flush ⁽³⁾	White	ZB4BH01	0.029/0.064
		Black	ZB4BH02	0.029/0.064
		Green	ZB4BH03	0.029/0.064
		Red	ZB4BH04	0.029/0.064
		Yellow	ZB4BH05	0.029/0.064
		Blue	ZB4BH06	0.029/0.064

110045



ZB4BH02

Pushbuttons with projecting push ^{(1) (3)}				
Shape of head	Type of push	Color of push	Reference	Weight kg/lb
Heads only				
	Projecting	White	ZB4BH1	0.029/0.064
		Black	ZB4BH2	0.029/0.064
		Green	ZB4BH3	0.029/0.064
		Red	ZB4BH4	0.029/0.064
		Yellow	ZB4BH5	0.029/0.064
		Blue	ZB4BH6	0.029/0.064

110068



ZB4BH6

Heads with black metal bezel

To order, add a **7** to the references selected from above.
Example: **ZB4BH01** becomes **ZB4BH017**.

- ⁽¹⁾ For recommended maximum number of contacts constituting the body (fixing collar and contact) associated with the head, see [page 24](#).
- ⁽²⁾ Caps to be ordered separately (see [page 90](#))
- ⁽³⁾ To add customized markings on these references using the web customization tool, see [page 5](#).

Assembly of other products using:
 Combined sub-assemblies: see [page 82](#)
 Accessories: see [page 90](#)

Control and signaling units

Harmony XB4, metal

Illuminated pushbuttons, push-push, with integral LED

Illuminated pushbuttons with flush push ⁽¹⁾ ⁽²⁾

Shape of head	Type of push	Color of lens	Reference	Weight kg/lb
Heads only ⁽³⁾				
 Protected LED	Flush	White	ZB4BH013	0.026/0.057
		Green	ZB4BH033	0.026/0.057
		Red	ZB4BH043	0.026/0.057
		Orange	ZB4BH053	0.026/0.057
		Yellow	ZB4BH083	0.026/0.057
		Blue	ZB4BH063	0.026/0.057

110051



ZB4BH033

XB4_632_CPSCT16036



ZB4BH083

Illuminated pushbuttons with projecting push ⁽¹⁾ ⁽²⁾

Shape of head	Type of push	Color of lens	Reference	Weight kg/lb
Heads only ⁽³⁾				
 Protected LED	Projecting	White	ZB4BH13	0.026/0.057
		Green	ZB4BH33	0.026/0.057
		Red	ZB4BH43	0.026/0.057
		Orange	ZB4BH53	0.026/0.057
		Yellow	ZB4BH83	0.026/0.057
		Blue	ZB4BH63	0.026/0.057

110168



ZB4BH63

Heads with black metal bezel

To order, add a 7 to the references selected from above.
 Example: **ZB4BH013** becomes **ZB4BH0137**.

- (1) For recommended maximum number of contacts constituting the body (fixing collar and contact) associated with the head, see [page 24](#).
- (2) To add customized markings on these references using the web customization tool, see [page 5](#).
- (3) For use with bodies comprising a light source with integral LED only.

Assembly of other products using:
 Body/contact assemblies: see [page 76](#)
 Accessories: see [page 90](#)

Control and signaling units



Harmony XB4, metal

Flush mounted pushbuttons, push-push

XB4_632_CPMFS18254



ZB4FH02

Flush mounted pushbuttons with flush push for Ø 30 mm ⁽¹⁾				
Shape of head	Type of push	Color of push	Reference	Weight kg/lb
Heads only				
	Without cap ⁽²⁾	–	ZB4FH0	0.028/0.062
	Flush ⁽³⁾	White	ZB4FH01	0.029/0.064
		Black	ZB4FH02	0.029/0.064
		Green	ZB4FH03	0.029/0.064
		Red	ZB4FH04	0.029/0.064
		Yellow	ZB4FH05	0.029/0.064
		Blue	ZB4FH06	0.029/0.064

XB4_632_CPMFS18256



ZB4FH6

Flush mounted pushbuttons with projecting push for Ø 30 mm ⁽¹⁾ ⁽³⁾				
Shape of head	Type of push	Color of push	Reference	Weight kg/lb
Heads only				
	Projecting	White	ZB4FH1	0.029/0.064
		Black	ZB4FH2	0.029/0.064
		Green	ZB4FH3	0.029/0.064
		Red	ZB4FH4	0.029/0.064
		Yellow	ZB4FH5	0.029/0.064
		Blue	ZB4FH6	0.029/0.064

⁽¹⁾ For recommended maximum number of contacts constituting the body (fixing collar and contact) associated with the head, see [page 24](#).

⁽²⁾ Caps to be ordered separately (see [page 90](#)).

⁽³⁾ To add customized markings on these references using the web customization tool, see [page 5](#).

Assembly of other products using:
 Combined sub-assemblies: see [page 82](#)
 Accessories: see [page 90](#)

Control and signaling units

Harmony XB4, metal

Flush mounted illuminated pushbuttons, push-push,
 with integral LED



ZB4FH033

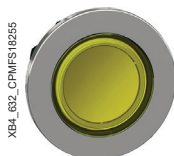

ZB4FH083

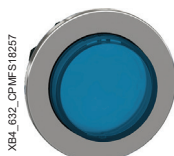

ZB4FH63

Flush mounted illuminated pushbuttons with flush push for Ø 30 mm ^{(1) (2)}

Shape of head	Type of push	Color of lens	Reference	Weight kg/lb
Heads only (3)				
	Flush	White	ZB4FH013	0.026/0.057
		Green	ZB4FH033	0.026/0.057
		Red	ZB4FH043	0.026/0.057
		Orange	ZB4FH053	0.026/0.057
		Blue	ZB4FH063	0.026/0.057
		Yellow	ZB4FH083	0.026/0.057

Flush mounted illuminated pushbuttons with projecting push for Ø 30 mm ^{(1) (2)}

Shape of head	Type of push	Color of lens	Reference	Weight kg/lb
Heads only (3)				
	Projecting	White	ZB4FH13	0.026/0.057
		Green	ZB4FH33	0.026/0.057
		Red	ZB4FH43	0.026/0.057
		Orange	ZB4FH53	0.026/0.057
		Blue	ZB4FH63	0.026/0.057
		Yellow	ZB4FH83	0.026/0.057







(1) For recommended maximum number of contacts constituting the body (fixing collar and contact) associated with the head, see [page 24](#).



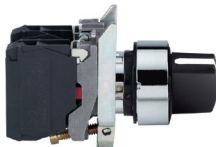



(2) To add customized markings on these references using the web customization tool, see [page 5](#).

(3) For use with bodies comprising a light source with integral LED only.

Assembly of other products using:
 Body/contact assemblies: see [page 76](#)
 Accessories: see [page 90](#)

Selector switches with standard handle ⁽¹⁾						
Screw clamp terminal connections (Schneider Electric anti-loosening system)						
Shape of head	Type of operator	Type of contact		Positions		Reference
		NO	NC	Number	Type	

Complete units							
	Standard handle, black	1	–	2-position 90°	Stay put	 XB4BD21 (ZB4BZ101 + ZB4BD2)	0.095/0.209
		1	–		Spring return from right to left	 XB4BD41 (ZB4BZ101 + ZB4BD4)	0.100/0.220
		1	1		Stay put	 XB4BD25 (ZB4BZ105 + ZB4BD2)	0.095/0.209
		2	–	3-position ± 45°	Stay put	 XB4BD33 (ZB4BZ103 + ZB4BD3)	0.095/0.209
					Spring return to center	 XB4BD53 (ZB4BZ103 + ZB4BD5)	0.095/0.209

Heads only ⁽²⁾							
	Standard handle, black			2-position 90°	Stay put	 ZB4BD2	0.040/0.088
					Spring return from right to left	 ZB4BD4	0.045/0.099
				3-position ± 45°	Stay put	 ZB4BD3	0.040/0.088
					Spring return to center	 ZB4BD5	0.040/0.088
					Spring return from left to center	 ZB4BD7	0.040/0.088
					Spring return from right to center	 ZB4BD8	0.040/0.088

Heads only with other colored handles		
	Standard handle, white	Add suffix 01 to the reference, example: ZB4BD201
	Standard handle, green	Add suffix 03 to the reference, example: ZB4BD203
	Standard handle, red	Add suffix 04 to the reference, example: ZB4BD204
	Standard handle, yellow	Add suffix 05 to the reference, example: ZB4BD205
	Standard handle, blue	Add suffix 06 to the reference, example: ZB4BD206

Heads with black metal bezel

For heads with standard black handle only. To order, add the suffix 7 to the references selected from above. Example: **ZB4BD2** becomes **ZB4BD27**.

(1) For recommended maximum number of contacts and sequence of contacts constituting the body (fixing collar + contact) associated with the head, see [page 24](#).

(2) To add customized markings on these references using the web customization tool, see [page 5](#).

Assembly of other products using:
 Body/contact assemblies: see [page 76](#)
 Accessories: see [page 90](#)





Control and signaling units







Harmony XB4, metal

Selector switches with long handle: normal and padlockable

Selector switches with long handle ⁽¹⁾ Screw clamp terminal connections (Schneider Electric anti-loosening system)

Shape of head	Type of operator	Type of contact		Positions		Reference	Weight kg/lb
		NO	NC	Number	Type		

Complete units								
	Long handle, black	1	-	2-position 90°	Stay put		XB4BJ21 (ZB4BZ101 + ZB4BJ2)	0.096/0.212
				3-position ±45°	Stay put		XB4BJ33 (ZB4BZ103 + ZB4BJ3)	0.096/0.212
					Spring return to center		XB4BJ53 (ZB4BZ103 + ZB4BJ5)	0.096/0.212

Heads only								
	Long handle, black (2)	-	-	2-position 90°	Stay put		ZB4BJ2	0.040/0.088
					Spring return from right to left		ZB4BJ4	0.045/0.099
				3-position ±45°	Stay put		ZB4BJ3	0.040/0.088
					Spring return to center		ZB4BJ5	0.040/0.088
					Spring return from left to center		ZB4BJ7	0.040/0.088
					Spring return from right to center		ZB4BJ8	0.040/0.088

Heads with black metal bezel

To order, add a 7 to the references selected from above.
 Example: **ZB4BJ2** becomes **ZB4BJ27**.

(1) For recommended maximum number of contacts and sequence of contacts constituting the body (fixing collar + contact) associated with the head, see [page 24](#).

(2) To add customized markings on these references using the web customization tool, see [page 5](#).

PF1106190

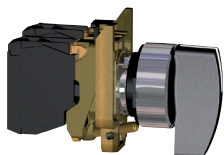

ZB4BJ33

PF1106196



ZB4BJ3

Assembly of other products using:
 Body/contact assemblies: see page 76
 Accessories: see page 90





Control and signaling units

Harmony XB4, metal









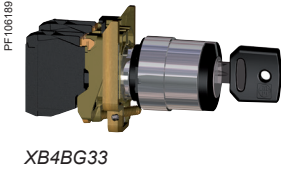









Key switches

Key no. 455, 421E, 458A, 520E, and 3131A

Key switches ^{(1) (2)}						
Screw clamp terminal connections (Schneider Electric anti-loosening system)						
Shape of head	Type of operator	Type of contact		Positions		Reference
		NO	NC	Number	Type	

Complete units							
	Key switch with key no. 455	1	-	2-position 90°	Stay put	 XB4BG21 (ZB4BZ101 + ZB4BG2)	0.153/0.337
					Spring return to left	 XB4BG41 (ZB4BZ101 + ZB4BG4)	0.153/0.337
		2	-	3-position ± 45°	Stay put	 XB4BG03 (ZB4BZ103 + ZB4BG0)	0.153/0.337
						 XB4BG33 (ZB4BZ103 + ZB4BG3)	0.153/0.337



Heads only								
	Key switch with key no. 455 ^{(3) (4)}	1	-	2-position 90°	Stay put	 ZB4BG2 ⁽⁵⁾	0.098/0.216	
						 ZB4BG02	0.098/0.216	
						 ZB4BG4	0.098/0.216	
					Spring return from right to left	 ZB4BG6	0.098/0.216	
					3-position ± 45°	Stay put	 ZB4BG0	0.098/0.216
							 ZB4BG03	0.098/0.216
							 ZB4BG04	0.098/0.216
							 ZB4BG3	0.098/0.216
						 ZB4BG5	0.098/0.216	
						 ZB4BG9	0.098/0.216	
						 ZB4BG09	0.098/0.216	
				Spring return from left to center		 ZB4BG1	0.098/0.216	
					 ZB4BG01	0.098/0.216		
				Spring return to center	 ZB4BG7	0.098/0.216		
				Spring return from right to center	 ZB4BG8	0.098/0.216		
					 ZB4BG05	0.098/0.216		
	 ZB4BG08	0.098/0.216						



Heads with black metal bezel

To order, add a **7** to the references selected from above. Example: **ZB4BG2** becomes **ZB4BG27**.

(1) For recommended maximum number of contacts and sequence of contacts constituting the body (fixing collar and contact) associated with the head, see page 24.

(2) The symbol  indicates key withdrawal position(s).

(3) Other key numbers:
 - Key no. 421E: Add suffix **12** to the reference.
 - Key no. 458A: Add suffix **10** to the reference.
 - Key no. 520E: Add suffix **14** to the reference.
 - Key no. 3131A: Add suffix **20** to the reference.
 Example: For a switch head with key no. 421E, 2-position stay put, with key withdrawal from the left-hand position, the reference becomes: **ZB4BG212**.

(4) For specific keys with other numbers, please contact our Customer Care Center.

(5) To order a key selector switch with multi-chip barrel add a suffix **K** to the reference (example : ZB4BG2 becomes ZB4BG2K).











Assembly of other products using:
 Body/contact assemblies: see page 76
 Accessories: see page 90









Control and signaling units



Harmony XB4, metal

Key switches with TEC10 key

Selector switches with knurled knob, toggle switches

Key switches with TEC10 key							
Shape of head	Type of operator	Positions		Reference	Weight kg/lb		
		Number	Type				
Heads only							
	Key switch with TEC10 key	2-position 90°	Stay put		ZB4BG2TEC10	0.160/0.353	
					ZB4BG4TEC10	0.160/0.353	
				Spring return from right to left		ZB4BG6TEC10	0.170/0.375
						ZB4BG0TEC10	0.160/0.353
		3-position ± 45°	Stay put		ZB4BG3TEC10	0.160/0.353	
					ZB4BG5TEC10	0.160/0.353	
					ZB4BG9TEC10	0.160/0.353	
				Spring return to center		ZB4BG7TEC10	0.170/0.375
				Spring return from right to center		ZB4BG05TEC10	0.170/0.375
							

Selector switches with knurled knob (1)							
Shape of head	Type of operator	Positions		Reference	Weight kg/lb		
		Number	Type				
Heads only							
	Black knurled knob	2-position 90°	Stay put		ZB4BD29	0.043/0.095	
				Spring return from right to left		ZB4BD49	0.050/0.110
		3-position ± 45°	Stay put		ZB4BD39	0.040/0.088	
				Spring return to center		ZB4BD59	0.040/0.088
				Spring return from left to center		ZB4BD79	0.040/0.088
				Spring return from right to center		ZB4BD89	0.040/0.088
							

Toggle switches (1)						
Shape of head	Type of operator	Positions		Reference	Weight kg/lb	
		Number	Type			
Heads only						
	Black lever	2-position 90°	Stay put		ZB4BD28	0.026/0.057
				Spring return		ZB4BD48

Heads with black metal bezel

To order, add a 7 to the references selected from above.
 Example: **ZB4BD29** becomes **ZB4BD297**.

For the references with TEC10 key, add the 7 before TEC10.
 Example: **ZB4BG2TEC10** becomes **ZB4BG27TEC10**.

(1) For recommended maximum number of contacts and sequence of contacts constituting the body (fixing collar and contact) associated with the head, see page 24.

PF106198



ZB4BD29

814205







ZB4BD28

Assembly of other products using:
 Combined sub-assemblies: see page 76
 Accessories: see page 90

Control and signaling units

Harmony XB4, metal

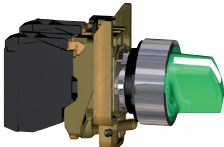
Illuminated selector switches with standard handle,
 with integral LED

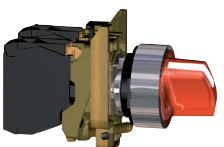





Illuminated selector switches with standard handle, with integral LED ⁽¹⁾															
Screw clamp terminal connections (Schneider Electric anti-loosening system)															
Shape of head	Type of operator	Type of contact	Positions Number Type	Supply voltage V	Color of handle	Reference	Weight kg/lb								
		 NO  NC													
 XB4BK123B5		Standard handle	1	1	2-position Stay put 90°	24 ~ (50/60 Hz)	Green	XB4BK123B5 (ZB4BW0B35 + ZB4BK1233)	0.101/0.223						
							Red	XB4BK124B5 (ZB4BW0B45 + ZB4BK1243)	0.101/0.223						
							Orange	XB4BK125B5 (ZB4BW0B55 + ZB4BK1253)	0.101/0.223						
						110...120 ~ (50/60 Hz)	Green	XB4BK123G5 (ZB4BW0G35 + ZB4BK1233)	0.101/0.223						
							Red	XB4BK124G5 (ZB4BW0G45 + ZB4BK1243)	0.101/0.223						
							Orange	XB4BK125G5 (ZB4BW0G55 + ZB4BK1253)	0.101/0.223						
						230...240 ~ (50/60 Hz)	Green	XB4BK123M5 (ZB4BW0M35 + ZB4BK1233)	0.101/0.223						
							Red	XB4BK124M5 (ZB4BW0M45 + ZB4BK1243)	0.101/0.223						
							Orange	XB4BK125M5 (ZB4BW0M55 + ZB4BK1253)	0.101/0.223						
						 XB4BK134B5		Standard handle	1	1	3-position Stay put ± 45°	24 ~ (50/60 Hz)	Green	XB4BK133B5 (ZB4BW0B35 + ZB4BK1333)	0.101/0.223
													Red	XB4BK134B5 (ZB4BW0B45 + ZB4BK1343)	0.101/0.223
													Orange	XB4BK135B5 (ZB4BW0B55 + ZB4BK1353)	0.101/0.223
110...120 ~ (50/60 Hz)	Green	XB4BK133G5 (ZB4BW0G35 + ZB4BK1333)	0.101/0.223												
	Red	XB4BK134G5 (ZB4BW0G45 + ZB4BK1343)	0.101/0.223												
	Orange	XB4BK135G5 (ZB4BW0G55 + ZB4BK1353)	0.101/0.223												
230...240 ~ (50/60 Hz)	Green	XB4BK133M5 (ZB4BW0M35 + ZB4BK1333)	0.101/0.223												
	Red	XB4BK134M5 (ZB4BW0M45 + ZB4BK1343)	0.101/0.223												
	Orange	XB4BK135M5 (ZB4BW0M55 + ZB4BK1353)	0.101/0.223												

(1) For recommended maximum number of contacts constituting the body (fixing collar and contact) associated with the head, see page 24.

Control and signaling units

Harmony XB4, metal

Illuminated selector switches with standard handle,
 with integral LED

Illuminated selector switches with standard handle, with integral LED (continued) (1)							
Shape of head	Type of operator	Positions		Color of handle	Reference	Weight kg/lb	
		Number	Type				
Heads only (2)							
	Standard handle	2-position 90°	Stay put		White	ZB4BK1213	0.036/0.079
					Green	ZB4BK1233	0.036/0.079
					Red	ZB4BK1243	0.036/0.079
					Orange	ZB4BK1253	0.036/0.079
					Yellow	ZB4BK1283	0.036/0.079
					Blue	ZB4BK1263	0.036/0.079
			Spring return from right to left		White	ZB4BK1413	0.037/0.082
					Green	ZB4BK1433	0.037/0.082
					Red	ZB4BK1443	0.037/0.082
					Orange	ZB4BK1453	0.037/0.082
					Yellow	ZB4BK1483	0.037/0.082
					Blue	ZB4BK1463	0.037/0.082
		3-position ± 45°	Stay put		White	ZB4BK1313	0.036/0.079
					Green	ZB4BK1333	0.036/0.079
					Red	ZB4BK1343	0.036/0.079
					Orange	ZB4BK1353	0.036/0.079
					Yellow	ZB4BK1383	0.036/0.079
					Blue	ZB4BK1363	0.036/0.079
			Spring return to center		White	ZB4BK1513	0.036/0.079
					Green	ZB4BK1533	0.036/0.079
					Red	ZB4BK1543	0.036/0.079
					Orange	ZB4BK1553	0.036/0.079
					Yellow	ZB4BK1583	0.036/0.079
					Blue	ZB4BK1563	0.036/0.079
Spring return from right to center		White	ZB4BK1813	0.036/0.079			
		Green	ZB4BK1833	0.036/0.079			
		Red	ZB4BK1843	0.036/0.079			
		Orange	ZB4BK1853	0.036/0.079			
		Yellow	ZB4BK1883	0.036/0.079			
		Blue	ZB4BK1863	0.036/0.079			
Spring return from left to center		White	ZB4BK1713	0.036/0.079			
		Green	ZB4BK1733	0.036/0.079			
		Red	ZB4BK1743	0.036/0.079			
		Orange	ZB4BK1753	0.036/0.079			
		Yellow	ZB4BK1783	0.036/0.079			
		Blue	ZB4BK1763	0.036/0.079			



ZB4BK1343

Heads with black metal bezel

To order, add a 7 to the references selected from above.
 Example: **ZB4BK1213** becomes **ZB4BK12137**.



- (1) For recommended maximum number of contacts constituting the body (fixing collar and contact) associated with the head, see page 24.
 (2) For use with bodies comprising a light source with integral LED only.

Assembly of other products using:
 Body/contact assemblies: see [page 76](#)
 Accessories: see [page 90](#)

Control and signaling units

Harmony XB4, metal

Flush mounted selector switches with standard handle

Flush mounted selector switches with standard handle for Ø 30 mm ⁽¹⁾									
Screw clamp terminal connections (Schneider Electric anti-loosening system)									
Shape of head	Type of operator	Type of contact	Marking on bezel	Positions		Reference	Weight		
		NO	NC	Text (color)	Number	Type		kg/lb	
Complete units ⁽²⁾									
	Standard handle, black	1	–	–	2-position 90°	Stay put	✓	XB4FD21 (ZB4BZ101 + ZB4FD2)	0.095/0.209
		1	–	–		Spring return from right to left	↶	XB4FD41 (ZB4BZ101 + ZB4FD4)	0.100/0.220
		1	1	–		Stay put	✓	XB4FD25 (ZB4BZ105 + ZB4FD2)	0.095/0.209
		2	–	–	3-position ± 45°	Stay put	↓	XB4FD33 (ZB4BZ103 + ZB4FD3)	0.095/0.209
						Spring return to center	↕	XB4FD53 (ZB4BZ103 + ZB4FD5)	0.095/0.209
Heads only ⁽²⁾									
	Standard handle, black			–	2-position 90°	Stay put	✓	ZB4FD2	0.040/0.088
						Spring return from right to left	↶	ZB4FD4	0.045/0.099
					3-position ± 45°	Stay put	↓	ZB4FD3	0.040/0.088
						Spring return to center	↕	ZB4FD5	0.040/0.088
						Spring return from left to center	↷	ZB4FD7	0.040/0.088
				Spring return from right to center	↶	ZB4FD8	0.040/0.088		
Heads only with marked bezel									
	Standard handle, black (3)			"O" and "I"	2-position 90°	Stay put		ZB4FD2M178	0.040/0.088
Heads only with other colored handles									
	Standard handle, white							Add suffix 01 to the reference, example: ZB4FD201	
	Standard handle, green							Add suffix 03 to the reference, example: ZB4FD203	
	Standard handle, red							Add suffix 04 to the reference, example: ZB4FD204	
	Standard handle, yellow							Add suffix 05 to the reference, example: ZB4FD205	
	Standard handle, blue							Add suffix 06 to the reference, example: ZB4FD206	

(1) For recommended maximum number of contacts and sequence of contacts constituting the body (fixing collar + contact) associated with the head, see [page 24](#).

(2) To add customized markings on these references using the web customization tool, see [page 5](#).



(3) The symbol indicates the padlocking positions.

Assembly of other products using:
 Body/contact assemblies: see [page 76](#)
 Accessories: see [page 90](#)

Control and signaling units

Harmony XB4, metal

Flush mounted selector switches with long handle:
 normal and padlockable

Flush mounted selector switches with long handle for Ø 30 mm ⁽¹⁾							
Screw clamp terminal connections (Schneider Electric anti-loosening system)							
Shape of head	Type of operator	Type of contact		Positions		Reference	Weight kg/lb
		NO	NC	Number	Type		
Complete units ⁽²⁾							
	Long handle, black (3)	1	-	2-position	Stay put	✓ XB4FJ21 (ZB4BZ101 + ZB4FJ2)	0.096/0.212
				90°			
				3-position	Stay put	✓ XB4FJ33 (ZB4BZ103 + ZB4FJ3)	0.096/0.212
± 45°							
					Spring return to center	✓ XB4FJ53 (ZB4BZ103 + ZB4FJ5)	0.096/0.212
Heads only							
	Long handle, black			2-position	Stay put	✓ ZB4FJ2	0.040/0.088
				90°			
					Spring return from right to left	✓ ZB4FJ4	0.045/0.099
				3-position	Stay put	✓ ZB4FJ3	0.040/0.088
				± 45°			
					Spring return to center	✓ ZB4FJ5	0.040/0.088
					Spring return from left to center	✓ ZB4FJ7	0.040/0.088
					Spring return from right to center	✓ ZB4FJ8	0.040/0.088



(1) For recommended maximum number of contacts and sequence of contacts constituting the body (fixing collar + contact) associated with the head, see [page 24](#).

(2) To add customized markings on these references using the web customization tool, see [page 5](#).

Assembly of other products using:
 Body/contact assemblies: see [page 76](#)
 Accessories: see [page 20](#)

Control and signaling units







Harmony XB4, metal



















Flush mounted key switches with key no. 455

Flush mounted key switches for Ø 30 mm ^{(1) (2)}

Screw clamp terminal connections (Schneider Electric anti-loosening system)

Shape of head	Type of operator	Type of contact		Positions		Reference	Weight kg/lb
		NO	NC	Number	Type		

Complete units ⁽⁵⁾							
	Key switch with key no. 455	1	-	2-position 90°	Stay put	 XB4FG21 (ZB4BZ101 + ZB4FG2)	0.153/0.337
						 XB4FG41 (ZB4BZ101 + ZB4FG4)	0.153/0.337
		2	-	3-position ± 45°	Stay put	 XB4FG61 (ZB4BZ101 + ZB4FG6)	0.153/0.337
						 XB4FG03 (ZB4BZ103 + ZB4FG0)	0.153/0.337
						 XB4FG33 (ZB4BZ103 + ZB4FG3)	0.153/0.337

Heads only							
	Key switch with key no. 455 ^{(3) (4)}			2-position 90°	Stay put	 ZB4FG2 (5)	0.098/0.216
						 ZB4FG02 (5)	0.098/0.216
				 ZB4FG4 (5)	0.098/0.216		
				Spring return from right to left	 ZB4FG6 (5)	0.098/0.216	
					3-position ± 45°	Stay put	 ZB4FG0 (5)
				 ZB4FG03			0.098/0.216
				 ZB4FG04	0.098/0.216		
				 ZB4FG3 (5)	0.098/0.216		
				 ZB4FG5	0.098/0.216		
				 ZB4FG9 (5)	0.098/0.216		
				 ZB4FG09	0.098/0.216		
				Spring return from left to center	 ZB4FG1	0.098/0.216	
					 ZB4FG01	0.098/0.216	
				Spring return to center	 ZB4FG7 (5)	0.098/0.216	
				Spring return from right to center	 ZB4FG8 (5)	0.098/0.216	
					 ZB4FG05 (5)	0.098/0.216	
 ZB4FG08 (5)	0.098/0.216						

(1) For recommended maximum number of contacts and sequence of contacts constituting the body (fixing collar and contact) associated with the head, see [page 24](#).

(2) The symbol  indicates key withdrawal position(s).

(3) Other key numbers:

Place an order using the generic reference and adding a technical text based on the key number suffix to the standard reference:

- Key no. 421E: Order using generic reference ZB4FG●K and add suffix 12 to the technical reference

- Key no. 458A: Order using generic reference ZB4FG●K and add suffix 10 to the technical reference

- Key no. 520E: Order using generic reference ZB4FG●K and add suffix 14 to the technical reference

- Key no. 3131A: Order using generic reference ZB4FG●C and add suffix 20 to the technical reference

Example: For a switch head with key no. 421E, 2-position stay put, and key withdrawal from the left-hand position, the generic reference to order is ZB4FG2K and the technical text is ZB4FG212.

(4) For specific keys with other numbers, please contact our Customer Care Center.

(5) To add customized markings on these references using the web customization tool, see [page 5](#).

Assembly of other products using:
 Body/contact assemblies: see [page 76](#)
 Accessories: see [page 90](#)

Control and signaling units

Harmony XB4, metal

Key switches with TEC10 key

Flush mounted selector switches with knurled knob



ZB4FD29

Selector switches with knurled knob (1)

Shape of head	Type of operator	Positions			Reference	Weight kg/lb
		Number	Type			
Heads only						
	Black knurled knob	2-position 90°	Stay put		ZB4FD29	0.043/0.095
		3-position ± 45°	Stay put		ZB4FD39	0.040/0.088
			Spring return to center		ZB4FD59 (2)	0.040/0.088
			Spring return from left to center		ZB4FD79	0.040/0.088
			Spring return from right to center		ZB4FD89	0.040/0.088

(1) For recommended maximum number of contacts and sequence of contacts constituting the body (fixing collar and contact) associated with the head, see [page 24](#).

(2) To add customized markings on these references using the web customization tool, see [page 5](#).

References

Assembly of other products using:
 Combined sub-assemblies: see [page 76](#)
 Accessories: see [page 90](#)

Control and signaling units

Harmony XB4, metal

Flush mounted illuminated selector switches with standard handle, with integral LED

Flush mounted illuminated selector switches with standard handle, with integral LED for Ø 30 mm (1)

Screw clamp terminal connections (Schneider Electric anti-loosening system)

Shape of head	Type of operator	Type of contact		Positions Number Type	Supply voltage V	Color of handle	Reference	Weight kg/lb					
													
Complete units													
 XB4FK123B5	Standard handle	1	1	2-position Stay put  90°	24 ~ (50/60 Hz)	Green	XB4FK123B5 (2) (ZB4BW0B35 + ZB4FK1233)	0.101/0.223					
						Red	XB4FK124B5 (2) (ZB4BW0B45 + ZB4FK1243)	0.101/0.223					
						Orange	XB4FK125B5 (2) (ZB4BW0B55 + ZB4FK1253)	0.101/0.223					
						110...120 ~ (50/60 Hz)	Green	XB4FK123G5 (2) (ZB4BW0G35 + ZB4FK1233)	0.101/0.223				
						Red	XB4FK124G5 (ZB4BW0G45 + ZB4FK1243)	0.101/0.223					
						Orange	XB4FK125G5 (2) (ZB4BW0G55 + ZB4FK1253)	0.101/0.223					
						230...240 ~ (50/60 Hz)	Green	XB4FK123M5 (2) (ZB4BW0M35 + ZB4FK1233)	0.101/0.223				
						Red	XB4FK124M5 (2) (ZB4BW0M45 + ZB4FK1243)	0.101/0.223					
						Orange	XB4FK125M5 (2) (ZB4BW0M55 + ZB4FK1253)	0.101/0.223					
						 XB4FK134B5	1	1	3-position Stay put  ± 45°	24 ~ (50/60 Hz)	Green	XB4FK133B5 (2) (ZB4BW0B35 + ZB4FK1333)	0.101/0.223
											Red	XB4FK134B5 (ZB4BW0B45 + ZB4FK1343)	0.101/0.223
											Orange	XB4FK135B5 (ZB4BW0B55 + ZB4FK1353)	0.101/0.223
110...120 ~ (50/60 Hz)	Green	XB4FK133G5 (ZB4BW0G35 + ZB4FK1333)	0.101/0.223										
Red	XB4FK134G5 (ZB4BW0G45 + ZB4FK1343)	0.101/0.223											
Orange	XB4FK135G5 (ZB4BW0G55 + ZB4FK1353)	0.101/0.223											
230...240 ~ (50/60 Hz)	Green	XB4FK133M5 (2) (ZB4BW0M35 + ZB4FK1333)	0.101/0.223										
Red	XB4FK134M5 (ZB4BW0M45 + ZB4FK1343)	0.101/0.223											
Orange	XB4FK135M5 (ZB4BW0M55 + ZB4FK1353)	0.101/0.223											

(1) For recommended maximum number of contacts constituting the body (fixing collar and contact) associated with the head, see [page 24](#).

(2) To add customized markings on these references using the web customization tool, see [page 5](#).







Assembly of other products using:
 Combined sub-assemblies: see [page 76](#)
 Accessories: see [page 90](#)

Control and signaling units

Harmony XB4, metal

Flush mounted illuminated selector switches with standard handle, with integral LED

Flush mounted illuminated selector switches with standard handle, with integral LED for Ø 30 mm (continued) (1)

Shape of head	Type of operator	Positions		Color of handle	Reference	Weight kg/lb		
		Number	Type					
Heads only (2)								
	Protected LED	Standard handle	2-position 90°	Stay put		White	ZB4FK1213 (3)	0.036/0.079
						Green	ZB4FK1233 (3)	0.036/0.079
						Red	ZB4FK1243 (3)	0.036/0.079
						Orange	ZB4FK1253 (3)	0.036/0.079
						Blue	ZB4FK1263 (3)	0.036/0.079
						Yellow	ZB4FK1283 (3)	0.036/0.079
			Spring return from right to left		White	ZB4FK1413 (3)	0.037/0.082	
					Green	ZB4FK1433 (3)	0.037/0.082	
					Red	ZB4FK1443 (3)	0.037/0.082	
					Orange	ZB4FK1453 (3)	0.037/0.082	
					Blue	ZB4FK1463	0.037/0.082	
					Yellow	ZB4FK1483 (3)	0.037/0.082	
			3-position ± 45°	Stay put		White	ZB4FK1313 (3)	0.036/0.079
						Green	ZB4FK1333 (3)	0.036/0.079
						Red	ZB4FK1343 (3)	0.036/0.079
						Orange	ZB4FK1353 (3)	0.036/0.079
						Blue	ZB4FK1363 (3)	0.036/0.079
						Yellow	ZB4FK1383 (3)	0.036/0.079
Spring return to center		White	ZB4FK1513 (3)	0.036/0.079				
		Green	ZB4FK1533 (3)	0.036/0.079				
		Red	ZB4FK1543 (3)	0.036/0.079				
		Orange	ZB4FK1553 (3)	0.036/0.079				
		Blue	ZB4FK1563 (3)	0.036/0.079				
		Yellow	ZB4FK1583 (3)	0.036/0.079				
Spring return from right to center		White	ZB4FK1813 (3)	0.036/0.079				
		Green	ZB4FK1833 (3)	0.036/0.079				
		Red	ZB4FK1843	0.036/0.079				
		Orange	ZB4FK1853 (3)	0.036/0.079				
		Blue	ZB4FK1863	0.036/0.079				
		Yellow	ZB4FK1883 (3)	0.036/0.079				
Spring return from left to center		White	ZB4FK1713 (3)	0.036/0.079				
		Green	ZB4FK1733 (3)	0.036/0.079				
		Red	ZB4FK1743 (3)	0.036/0.079				
		Orange	ZB4FK1753 (3)	0.036/0.079				
		Blue	ZB4FK1763	0.036/0.079				
		Yellow	ZB4FK1783 (3)	0.036/0.079				

(1) For recommended maximum number of contacts constituting the body (fixing collar and contact) associated with the head, see [page 24](#).

(2) For use with bodies comprising a light source with integral LED only.

(3) To add customized markings on these references using the web customization tool, see [page 5](#).

Assembly of other products using:
 Body/light assemblies: see [page 84](#)
 Accessories: see [page 90](#)

Pilot lights with integral LED ⁽¹⁾				
Screw clamp terminal connections (Schneider Electric anti-loosening system)				
Shape of head	Supply voltage V	Color	Reference	Weight kg/lb
Complete units				
■ With plain lens				
 101179 XB4BVB5 	24 ~ (50/60 Hz)	White	XB4BVB1 (ZB4BVB1 + ZB4BV013)	0.080/0.176
		Green	XB4BVB3 (ZB4BVB3 + ZB4BV033)	0.080/0.176
		Red	XB4BVB4 (ZB4BVB4 + ZB4BV043)	0.080/0.176
		Orange	XB4BVB5 (ZB4BVB5 + ZB4BV053)	0.080/0.176
		Blue	XB4BVB6 (ZB4BVB6 + ZB4BV063)	0.080/0.176
		110...120 ~ (50/60 Hz)	White	XB4BVG1 (ZB4BVG1 + ZB4BV013)
	Green		XB4BVG3 (ZB4BVG3 + ZB4BV033)	0.080/0.176
	Red		XB4BVG4 (ZB4BVG4 + ZB4BV043)	0.080/0.176
	Orange		XB4BVG5 (ZB4BVG5 + ZB4BV053)	0.080/0.176
	Blue		XB4BVG6 (ZB4BVG6 + ZB4BV063)	0.080/0.176
	230...240 ~ (50/60 Hz)		White	XB4BVM1 (ZB4BVM1 + ZB4BV013)
		Green	XB4BVM3 (ZB4BVM3 + ZB4BV033)	0.080/0.176
		Red	XB4BVM4 (ZB4BVM4 + ZB4BV043)	0.080/0.176
		Orange	XB4BVM5 (ZB4BVM5 + ZB4BV053)	0.080/0.176
		Blue	XB4BVM6 (ZB4BVM6 + ZB4BV063)	0.080/0.176

(1) To add customized markings on these references using the web customization tool, see [page 5](#).

Control and signaling units

Harmony XB4, metal

Pilot lights with integral LED

Pilot lights with integral LED					
Screw clamp terminal connections (Schneider Electric anti-loosening system)					
Heads only (1)					
Shape of head	For use with body comprising light source type	Color of lens	Reference	Weight kg/lb	
■ With plain lens					
 	Integral LED only	White	ZB4BV013 (2)	0.026/0.057	
		Green	ZB4BV033 (2)	0.026/0.057	
		Red	ZB4BV043 (2)	0.026/0.057	
		Orange	ZB4BV053 (2)	0.026/0.057	
		Yellow	ZB4BV083 (2)	0.026/0.057	
		Blue	ZB4BV063 (2)	0.026/0.057	
		5 colors (3) (4)	ZB4BV003	0.026/0.057	
■ With plain lens, for insertion of legend (4)					
 	Integral LED only	White	ZB4BV013E	0.026/0.057	
		Green	ZB4BV033E	0.026/0.057	
		Red	ZB4BV043E	0.026/0.057	
		Orange	ZB4BV053E	0.026/0.057	
		Yellow	ZB4BV083E	0.026/0.057	
		Blue	ZB4BV063E	0.026/0.057	
		■ With grooved lens (5) (2)			
 	Integral LED only	White	ZB4BV013S	0.026/0.057	
		Green	ZB4BV033S	0.026/0.057	
		Red	ZB4BV043S	0.026/0.057	
		Orange	ZB4BV053S	0.026/0.057	
		Yellow	ZB4BV083S	0.026/0.057	
		Blue	ZB4BV063S	0.026/0.057	

(1) For use with bodies comprising a light source with integral LED only.

(2) To add customized markings on these references using the web customization tool, see [page 5](#).

(3) Head supplied with 5 different colored lenses (white, green, red, orange, and blue) not fitted, for insertion of legend.

(4) For legend ordering information, see [page 99](#).

(5) For use in bright ambient light conditions (for example, outdoors in sunlight).

Assembly of other products using:
 Body/light assemblies: see page 84
 Accessories: see page 90

Control and signaling units

Harmony XB4, metal

Pilot lights with integral LED and with BA 9s base fitting

Pilot lights with integral LED and transformer (1.2 VA, 24 V secondary) (1)

Screw clamp terminal connections (Schneider Electric anti-loosening system)

Shape of head	Supply voltage V	Color	Reference	Weight kg/lb
Complete units - With plain lens				
	400 ~ - 50 Hz (2)	White	XB4BV5B1	0.172/0.379
		Green	XB4BV5B3	0.172/0.379
		Red	XB4BV5B4	0.172/0.379
		Orange	XB4BV5B5	0.172/0.379
		Blue	XB4BV5B6	0.172/0.379

PF512544

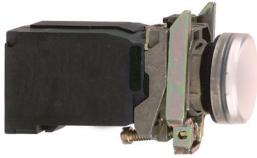



XB4BV5B1

Protected LED

Pilot lights with BA 9s base fitting, with plain or grooved lens (1)

Screw clamp terminal connections (Schneider Electric anti-loosening system)

Shape of head	Supply voltage V	Color	Reference	Weight kg/lb
Complete units - With plain lens				
■ Direct supply, for BA 9s bulb, U ≤ 250 V, 2.4 W max (bulb not included)				
	≤ 250	White	XB4BV61 (ZB4BV6 + ZB4BV01)	0.075/0.165
		Green	XB4BV63 (ZB4BV6 + ZB4BV03)	0.075/0.165
		Red	XB4BV64 (ZB4BV6 + ZB4BV04)	0.075/0.165
		Orange	XB4BV65 (ZB4BV6 + ZB4BV05)	0.075/0.165
■ Via integral transformer, 1.2 VA, 6 V secondary, with BA 9s incandescent bulb (included)				
	110...120 ~ - 50/60 Hz	White	XB4BV31 (ZB4BV3 + ZB4BV01)	0.152/0.335
		Green	XB4BV33 (ZB4BV3 + ZB4BV03)	0.152/0.335
		Red	XB4BV34 (ZB4BV3 + ZB4BV04)	0.152/0.335
		Orange	XB4BV35 (ZB4BV3 + ZB4BV05)	0.152/0.335
	230 ~ - 50 Hz	White	XB4BV41 (ZB4BV4 + ZB4BV01)	0.152/0.335
	220...240 ~ - 60 Hz	Green	XB4BV43 (ZB4BV4 + ZB4BV03)	0.152/0.335
		Red	XB4BV44 (ZB4BV4 + ZB4BV04)	0.152/0.335
		Orange	XB4BV45 (ZB4BV4 + ZB4BV05)	0.152/0.335

101176-88-Q

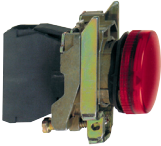

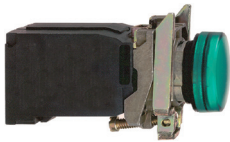

XB4BV64

PF512545-88-Q



XB4BV33

Heads only (3)

Shape of head	For use with body comprising light source type	Color of lens	Reference	Weight kg/lb
■ With plain lens				
	With BA 9s base fitting	White	ZB4BV01	0.027/0.060
		Green	ZB4BV03	0.027/0.060
		Red	ZB4BV04	0.027/0.060
		Orange	ZB4BV05	0.027/0.060
		Blue	ZB4BV06	0.027/0.060
		Clear	ZB4BV07	0.027/0.060
■ With grooved lens (4)				
	With BA 9s base fitting	White	ZB4BV01S	0.027/0.060
		Green	ZB4BV03S	0.027/0.060
		Red	ZB4BV04S	0.027/0.060
		Orange	ZB4BV05S	0.027/0.060
		Blue	ZB4BV06S	0.027/0.060
		Clear	ZB4BV07S	0.027/0.060

101234



ZB4BV04

PG113109-34-Q



ZB4BV06S

(1) To add customized markings on these references using the web customization tool, see page 5.

(2) To order 440...460 V ~ - 60 Hz transformer blocks, replace "5" in the reference with "8". Example: **XB4BV5B1** becomes **XB4BV8B1**. To order 550...600 V ~ - 60 Hz blocks, replace "5" with "9". Example: **XB4BV5B1** becomes **XB4BV9B1**.

(3) For use with bodies comprising a light source with BA 9s base fitting (incandescent, neon, or LED) only.

(4) For use in bright ambient light conditions (for example, outdoors in sunlight).

Assembly of other products using:
 Body/light assemblies: see page 84
 Accessories: see page 90

Control and signaling units

Harmony XB4, metal

Push-to-test pilot light



Push-to-test pilot light				
Shape of head	Supply voltage V	Color	Reference	Weight kg/lb
Complete units - With plain lens				
	24 ~ - 50/60 Hz	White	XB4BW21B5	0.090/0.198
	24 ~ - 50/60 Hz	Green	XB4BW23B5	0.090/0.198
	24 ~ - 50/60 Hz	Red	XB4BW24B5	0.090/0.198
	24 ~ - 50/60 Hz	Orange	XB4BW25B5	0.090/0.198
	24 ~ - 50/60 Hz	Yellow	XB4BW28B5	0.090/0.198
	24 ~ - 50/60 Hz	Blue	XB4BW26B5	0.090/0.198
	110...120 ~ - 50 - 60 Hz	White	XB4BW21G5	0.090/0.198
	110...120 ~ - 50 - 60 Hz	Green	XB4BW23G5	0.090/0.198
	110...120 ~ - 50 - 60 Hz	Red	XB4BW24G5	0.090/0.198
	110...120 ~ - 50 - 60 Hz	Orange	XB4BW25G5	0.090/0.198
	110...120 ~ - 50 - 60 Hz	Yellow	XB4BW28G5	0.090/0.198
	110...120 ~ - 50 - 60 Hz	Blue	XB4BW26G5	0.090/0.198

Assembly of other products using:
 Body/light assemblies: see [page 84](#)
 Accessories: see [page 90](#)

Control and signaling units

Harmony XB4, metal

Flush mounted pilot lights with integral LED

XB4_632_CP/MFS/0940



XB4FVB5

Flush mounted pilot lights with integral LED for Ø 30 mm (1) Screw clamp terminal connections (Schneider Electric anti-loosening system)

Shape of head	Supply voltage V	Color	Reference	Weight kg/lb
Complete units				
■ With plain lens				
	24 ~ (50/60 Hz)	White	XB4FVB1 (ZB4BVB1 + ZB4FV013)	0.080/0.176
		Green	XB4FVB3 (ZB4BVB3 + ZB4FV033)	0.080/0.176
		Red	XB4FVB4 (ZB4BVB4 + ZB4FV043)	0.080/0.176
		Orange	XB4FVB5 (ZB4BVB5 + ZB4FV053)	0.080/0.176
		Blue	XB4FVB6 (ZB4BVB6 + ZB4FV063)	0.080/0.176
		110...120 ~ (50/60 Hz)	White	XB4FVG1 (ZB4BVG1 + ZB4FV013)
	Green		XB4FVG3 (ZB4BVG3 + ZB4FV033)	0.080/0.176
	Red		XB4FVG4 (ZB4BVG4 + ZB4FV043)	0.080/0.176
	Orange		XB4FVG5 (ZB4BVG5 + ZB4FV053)	0.080/0.176
	Blue		XB4FVG6 (ZB4BVG6 + ZB4FV063)	0.080/0.176
	230...240 ~ (50/60 Hz)		White	XB4FVM1 (ZB4BVM1 + ZB4FV013)
		Green	XB4FVM3 (ZB4BVM3 + ZB4FV033)	0.080/0.176
		Red	XB4FVM4 (ZB4BVM4 + ZB4FV043)	0.080/0.176
		Orange	XB4FVM5 (ZB4BVM5 + ZB4FV053)	0.080/0.176
		Blue	XB4FVM6 (ZB4BVM6 + ZB4FV063)	0.080/0.176

(1) To add customized markings on these references using the web customization tool, see [page 5](#).

Assembly of other products using:
 Body/light assemblies: see [page 84](#)
 Accessories: see [page 90](#)

Control and signaling units

Harmony XB4, metal

Flush mounted pilot lights with integral LED

Flush mounted pilot lights with integral LED for Ø 30 mm (1) Screw clamp terminal connections (Schneider Electric anti-loosening system)

Heads only (2)

Shape of head	For use with body comprising light source type	Color of lens	Reference	Weight kg/lb
	Integral LED only	White	ZB4FV013	0.026/0.057
		Green	ZB4FV033	0.026/0.057
		Red	ZB4FV043	0.026/0.057
		Orange	ZB4FV053	0.026/0.057
		Blue	ZB4FV063	0.026/0.057
		Yellow	ZB4FV083	0.026/0.057



ZB4FV063

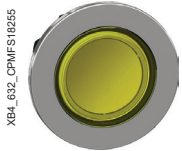

ZB4FV083

(1) To add customized markings on these references using the web customization tool, see [page 5](#).

(2) For use with bodies comprising a light source with integral LED only.

Assembly of other products using:
 Body/contact assemblies: see page 76
 Accessories: see page 90

Control and signaling units

Harmony XB4, metal

Specific functions

Pushbuttons for manual overload reset, Potentiometers

Manual overload reset pushbuttons

Shape of head	Travel mm/in.	Actuation distance mm/in.	Color	Reference	Weight kg/lb
With flush push					
	10/0.394	6...16/0.236...0.630	Black	XB4BA821	0.037/0.082
			Red	XB4BA841	0.037/0.082
			Blue	XB4BA861	0.037/0.082
	16...26/0.630...1.024	30...130/1.181...5.118	Black	XB4BA822	0.038/0.084
			Red	XB4BA842	0.038/0.084
			Blue	XB4BA862	0.038/0.084
	14/0.551	30...130/1.181...5.118	Black	XB4BA921	0.058/0.128
			Red	XB4BA941	0.058/0.128
			Blue	XB4BA961	0.058/0.128
	130...257/5.118...10.118	30...130/1.181...5.118	Black	XB4BA922	0.071/0.157
			Red	XB4BA942	0.071/0.157
			Blue	XB4BA962	0.071/0.157



XB4BA821

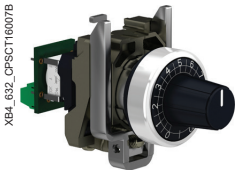

XB4BD912R1K

Complete potentiometers

Description	Resistance k Ω	Reference	Weight kg/lb
+/- 10% linear mode precision complete potentiometer with screw terminals	1	XB4BD912R1K	0.095/0.209
	4.7	XB4BD912R4K7	0.095/0.209
	10	XB4BD912R10K	0.095/0.209
	47	XB4BD912R47K	0.095/0.209
	100	XB4BD912R100K	0.095/0.209
	470	XB4BD912R470K	0.095/0.209

Heads and mounting base for potentiometer (1)

Shape of head	Description	For use with	Reference	Weight kg/lb
	For potentiometer with shaft length 45 to 50 mm/1.772 to 1.968 in.	6 mm/0.236 in. shaft	ZB4BD912	0.080/0.176
		6.35 mm/0.250 in. shaft	ZB4BD922	0.080/0.176

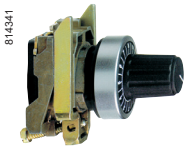

ZB4BD912

References

Assembly of other products using:
Body/contact assemblies: see page 76
Accessories: see page 90

Control and signaling units

Harmony XB4, metal

Specific functions

Timers, Hour counters, Annunciators, USB/RJ45 ports,

Fuse carrier



XB5DTB22



XB5DSB



XB5KS2B4



XB5DT1S



XB5PUSB3

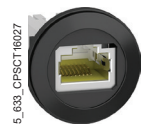

XB5PRJ45

Timers

Description	Output type	Supply voltage V	Time delay type	Reference	Weight kg/lb
Panel-mounted timer function with LED status and 1 static output in Ø 22.5 mm/0.886 in. hole	1 static output	24 $\bar{\sim}$	Type A (delay on energization)	XB5DTB22	0.027/0.060
				XB5DTB23	0.027/0.060
				XB5DTB24	0.027/0.060
				XB5DTB25	0.027/0.060
				XB5DTGM2	0.027/0.060
		100...240 $\bar{\sim}$ -50/60 Hz	Type A (delay on energization)	XB5DTGM3	0.027/0.060
				XB5DTGM4	0.027/0.060
				XB5DTGM5	0.027/0.060

Hour counters

Characteristics	Supply voltage V	Reference	Weight kg/lb
Indication 0...9999.9	12...24 $\bar{\sim}$ - 50 or 60 Hz	XB5DSB	0.045/0.099
	120 $\bar{\sim}$ - 60 Hz	XB5DSG	0.045/0.099
	230...240 $\bar{\sim}$ - 50 Hz	XB5DSM	0.045/0.099

Annunciators (IP 66, IP 67, and IP 69)

Characteristics	Supply voltage V	Color	Reference	Weight kg/lb
Continuous or intermittent non-illuminated buzzer - 90dB, 6.8kHz (connection diagram: on Schneider Electric website, Harmony XB5 page)	24 $\bar{\sim}$ - 50 or 60 Hz		XB5KSB	0.024/0.053
	110...120 $\bar{\sim}$ - 50 or 60 Hz		XB5KSG	0.024/0.053
	230...240 $\bar{\sim}$ - 50 or 60 Hz		XB5KSM	0.024/0.053
Continuous or intermittent illuminated buzzer - 90dB, 6.8kHz	24 $\bar{\sim}$ - 50 or 60 Hz	Red	XB5KS2B4	0.024/0.053
	110...120 V $\bar{\sim}$ - 50 or 60 Hz	Red	XB5KS2G4	0.024/0.053
	230...240 $\bar{\sim}$ - 50 or 60 Hz	Red	XB5KS2M4	0.024/0.053
	24V $\bar{\sim}$ - 50 or 60 Hz	Yellow	XB5KS2B8	0.024/0.053
	110...120 V $\bar{\sim}$ - 50 or 60 Hz	Yellow	XB5KS2G8	0.024/0.053
	230...240 $\bar{\sim}$ - 50 or 60 Hz	Yellow	XB5KS2M8	0.024/0.053

USB and RJ45 ports

Description	Interface type	Connection type	Reference	Weight kg/lb
Panel-mounted USB and RJ45 ports in Ø 22.5 mm/0.886 in. hole with notch	USB interface, jack type A	USB port 3.0 A-A	XB5PUSB3	0.017/0.037
	Ethernet interface, RJ45 jack	RJ45 port Cat. 6	XB5PRJ45	0.027/0.060

Fuse carrier

Description	For use with	Reference	Weight kg/lb
Fuse carrier	5 x 20 mm/0.787 in. fuse 6.3 A - 250 V	XB5DT1S	0.022/0.049

Presentation:
page 11

Assembly of other products using:
Accessories: see page 90

Control and signaling units

Harmony XB4, metal

Specific functions

Joystick controllers

10189

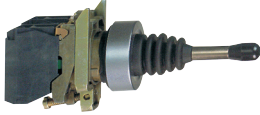

XD4PA12

Joystick controllers (with 54 mm/2.126 in. long operating shaft) (1) Screw clamp terminal connections (Schneider Electric anti-loosening system)

Description	Operation	Spring return to zero position	Reference	Weight kg/lb
Complete products				
2-direction	1 notch 1 NO contact per direction	Without	XD4PA12	0.116/0.256
		With	XD4PA22	0.116/0.256
4-direction	1 notch 1 NO contact per direction	Without	XD4PA14	0.133/0.293
		With	XD4PA24	0.133/0.293

103074

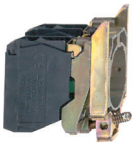

ZD4PA103

Sub-assemblies for joystick controllers

Description	Functions	Reference	Weight kg/lb	
Complete body/contact assemblies	2-direction	ZD4PA103	0.049/0.108	
	4-direction	ZD4PA203	0.058/0.128	
Complete head assemblies with operating shaft	2-direction, stay put	ZD4PA12	0.022/0.049	
	2-direction, spring return to zero position	ZD4PA22	0.022/0.049	
	4-direction, stay put	ZD4PA14	0.022/0.049	
	4-direction, spring return to zero position	ZD4PA24	0.022/0.049	
Legends 30 x 48 mm/ 1.181 x 1.890 in. for engraving	2-direction	Black on one side Red on reverse	ZBG2201	0.001/0.002
		White on one side Yellow on reverse	ZBG2401	0.001/0.002
Legends 48 x 48 mm/ 1.890 x 1.890 in. for engraving	4-direction	Black on one side Red on reverse	ZBG4201	0.002/0.004
		White on one side Yellow on reverse	ZBG4401	0.002/0.004

103072

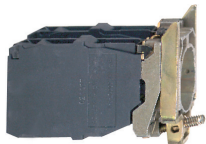

ZD4PA203

103073



ZD4PA12

Other versions Joystick controllers and complete body/contact assemblies for joystick controllers with Faston connector terminals (6.35 or 2 x 2.8 mm/0.250 or 2 x 0.110 in.). Please contact our Customer Care Center.

(1) Must not be used with standard contact blocks **ZBE10** (single) or **ZBE20** (double).

Assembly of other products using:
Accessories: see page 90

Control and signaling units

Harmony XB4, metal

Specific functions

Wobblesticks

Wobblestick heads

Shape of head	For use with	Color	Reference	Weight kg/lb
	Omnidirectional, spring return	Black	ZB4BB2	0.058/0.128
		Red	ZB4BB4	0.058/0.128



ZB4BB2

To combine with heads, see page 26 to 73

Control and signaling units

Harmony XB4, metal

Body/contact assemblies - Screw clamp terminal connections



ZB4BZ009



ZBE101



ZBE203

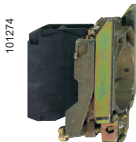

ZB4BZ101

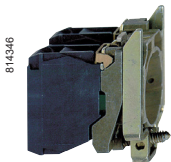

ZB4BZ106

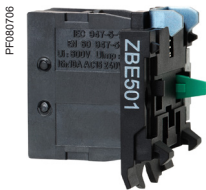

ZBE501



ZB2BE101

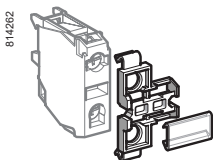

ZBZ001

Body/fixing collar			
For use with	Sold in lots of	Unit reference	Weight kg/lb
Electrical block (contact or light)	10	ZB4BZ009	0.038/0.084

Contact functions (1) Screw clamp terminal connections (Schneider Electric anti-loosening system)

Contacts for standard applications						
Description	Type of contact	NO	NC	Sold in lots of	Unit reference	Weight kg/lb
Contact blocks	Single	1	–	5	ZBE101	0.011/0.024
		–	1	5	ZBE102	0.011/0.024
	Double	2	–	5	ZBE203	0.020/0.044
		–	2	5	ZBE204	0.020/0.044
	Single with body/fixing collar	1	1	5	ZBE205	0.020/0.044
		1	–	1	ZB4BZ101	0.053/0.117
		–	1	1	ZB4BZ102	0.053/0.117
		2	–	1	ZB4BZ103	0.062/0.137
		–	2	1	ZB4BZ104	0.062/0.137
		1	1	1	ZB4BZ105	0.062/0.137
		1	2	1	ZB4BZ141	0.072/0.159

Contacts for specific applications							
Application	Type of contact	Description	NO	NC	Sold in lots of	Unit reference	Weight kg/lb
Low power switching	Single	Standard	1	–	5	ZBE1016	0.012/0.026
			–	1	5	ZBE1026	0.012/0.026
	Dusty environment (2) (IP 5X, 50 µm dust)	1	–	5	ZBE1016P	0.012/0.026	
		–	1	5	ZBE1026P	0.012/0.026	
Staggered contacts	Single	Early make NO	1	–	5	ZBE201	0.011/0.024
		Late break NC	–	1	5	ZBE202	0.011/0.024
	Single with body/fixing collar	Overlapping NO+NC	1	1	5	ZB4BZ106	0.062/0.137
		Staggered NO+NO	2	–	5	ZB4BZ107	0.062/0.137
High power switching	Single	Standard (3)	1	–	1	ZBE501	0.020/0.044
			–	1	1	ZBE502	0.020/0.044
			2	–	1	ZBE503	0.032/0.071
			–	2	1	ZBE504	0.032/0.071
			1	1	1	ZBE505	0.032/0.071
Additional contact blocks for high power switching	Single	Standard (4)	1	–	1	ZB2BE101	0.020/0.044
			–	1	1	ZB2BE102	0.020/0.044

Clip-on legend holder, sheet of blank legends and labelling software			
Description	Sold in lots of	Unit reference	Weight kg/lb
Clip-on legend-holder for electrical blocks with screw clamp terminal connections (5). For identification of an XB4B control or signaling unit	10	ZBZ001	0.001/0.002
Sheet of 50 blank legends for legend holder ZBZ001	10	ZBY001	0.023/0.051

(1) The contact blocks enable variable composition of body/contact assemblies. Maximum number of rows possible: 3. Either 3 rows of 3 single contacts or 1 row of 3 double contacts + 1 row of 3 single contacts (double contacts occupy the first 2 rows). Maximum number of contacts is specified on page 24.
 (2) It is not possible to fit an additional contact block on the back of these contact blocks.
 (3) It is not possible to use these contacts with light blocks.
 (4) To be fitted on the back of ZBE50● contacts.
 (5) This legend holder is not compatible with high power switching contacts.

To combine with heads,
see page 31

101288



ZBVB

Light blocks with screw clamp terminal connections (Schneider Electric anti-loosening system)					
Description	Supply voltage V	Color of light source	Sold in lots of	Unit reference	Weight kg/lb
Integral LED (to combine with heads for integral LED)	12 ~ (50/60 Hz)	White	5	ZBVJ1	0.017/0.037
		Green	5	ZBVJ3	0.017/0.037
		Red	5	ZBVJ4	0.017/0.037
		Orange	5	ZBVJ5	0.017/0.037
		Blue	5	ZBVJ6	0.017/0.037
		24 ~ (50/60 Hz)	White	5	ZBVB1
	Green	5	ZBVB3	0.017/0.037	
	Red	5	ZBVB4	0.017/0.037	
	Orange	5	ZBVB5	0.017/0.037	
	Yellow	5	ZBVB8	0.017/0.037	
	Blue	5	ZBVB6	0.017/0.037	
	24...120 ~ (50/60 Hz)	White	5	ZBVBG1	0.017/0.037
	Green	5	ZBVBG3	0.017/0.037	
	Red	5	ZBVBG4	0.017/0.037	
	Orange	5	ZBVBG5	0.017/0.037	
	Blue	5	ZBVBG6	0.017/0.037	
	110...120 ~ (50/60 Hz)	White	5	ZBVG1	0.017/0.037
	Green	5	ZBVG3	0.017/0.037	
Red	5	ZBVG4	0.017/0.037		
Orange	5	ZBVG5	0.017/0.037		
Yellow	5	ZBVG8	0.017/0.037		
Blue	5	ZBVG6	0.017/0.037		
230...240 ~ (50/60 Hz)	White	5	ZBVM1	0.017/0.037	
Green	5	ZBVM3	0.017/0.037		
Red	5	ZBVM4	0.017/0.037		
Orange	5	ZBVM5	0.017/0.037		
Yellow	5	ZBVM8	0.017/0.037		
Blue	5	ZBVM6	0.017/0.037		

Light blocks with inductive overload protection

Integral LED (to combine with heads for integral LED)	110...240 ~ (50/60 Hz)	White	5	ZBVM1T	0.017/0.037
		Green	5	ZBVM3T	0.017/0.037
		Red	5	ZBVM4T	0.017/0.037
		Orange	5	ZBVM5T	0.017/0.037
		Blue	5	ZBVM6T	0.017/0.037
		Yellow	5	ZBVM8T	0.017/0.037

XB5_CP18534

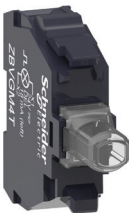

ZBVM4T

To combine with heads, see page 31

PF800705



ZBV5B

Flashing light blocks with screw clamp terminal connections (Schneider Electric anti-loosening system)

Integral LED (to combine with heads for integral LED)	Supply voltage V	Description	Quantity	Reference	Weight kg/lb
Protected LED	24 ~ (50/60 Hz)	White	5	ZBV18B1	0.017/0.037
		Green	5	ZBV18B3	0.017/0.037
		Red	5	ZBV18B4	0.017/0.037
		Orange	5	ZBV18B5	0.017/0.037
		Blue	5	ZBV18B6	0.017/0.037
		110...120 ~ (50/60 Hz)	White	5	ZBV18G1
Green	5		ZBV18G3	0.017/0.037	
Red	5		ZBV18G4	0.017/0.037	
Orange	5		ZBV18G5	0.017/0.037	
Blue	5		ZBV18G6	0.017/0.037	
230...240 ~ (50/60 Hz)	White		5	ZBV18M1	0.017/0.037
	Green	5	ZBV18M3	0.017/0.037	
	Red	5	ZBV18M4	0.017/0.037	
	Orange	5	ZBV18M5	0.017/0.037	
	Blue	5	ZBV18M6	0.017/0.037	

121461



ZBZG156

Transformer blocks for 24 V light blocks (1)

For use with	Supply voltage V	Description	Référence	Weight kg/lb
Light blocks with integral LED	400 V ~ - 50 Hz	Transformer 400 V - 24 V ~	ZBV5B (2)	0.090/0.198

121493



ZBZM156

Blocks for "test light" function

Light blocks	12 and 24 ~ 24...120 ~	Single module, 1 connecting wire	ZBZG156 (3)	0.010/0.022
Light blocks with integral LED	48...230 ~	Double module, with connecting wires	ZBZM156 (4)	0.010/0.022

(1) To be used with 2 dummy contact blocks ZBE000.

(2) To order 440...460 V ~ - 60 Hz transformer blocks, replace "5" in the reference with "8": ZBV5B becomes ZBV8B. To order 550...600 V ~ - 60 Hz transformer blocks, replace "5" with "9": ZBV5B becomes ZBV9B.

(3) Block for use with ~ light blocks with integral LED types ZBVJ●, ZVB●, ZVB BG● or with direct supply light block for BA 9s bulb, ZBV6.

(4) Block for use ~ light blocks integral LED types ZBVG●, ZBVM●, see connection on our website www.schneider-electric.com.

To combine with heads, see page 26 to 73

10191



ZB4BZ009

Body/fixing collar

For use with	Sold in lots of	Unit reference	Weight kg/lb
Electrical block (contact or light)	10	ZB4BZ009	0.038/0.084

PF10777



ZBE1015

Contact functions

Spring clamp terminal connections (1)

Contacts for standard applications

Description	Type of contact	Symbol		Sold in lots of	Unit reference	Weight kg/lb
		NO	NC			
Contact blocks	Single	1	–	4	ZBE1015	0.011/0.024
		–	1	4	ZBE1025	0.011/0.024
Contact blocks	Single with body/fixing collar	1	–	1	ZB4BZ1015	0.053/0.117
		–	1	1	ZB4BZ1025	0.053/0.117
		2	–	1	ZB4BZ1035	0.062/0.137
		–	2	1	ZB4BZ1045	0.062/0.137
		1	1	1	ZB4BZ1055	0.062/0.137
		–	–	–	–	–

PF10779

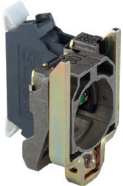

ZB4BZ1015

Control and signaling units

Harmony XB4, metal

Light blocks - Spring clamp terminal connections, blank legends

To combine with heads, see page 26 to 73

Light blocks					
Spring clamp terminal connections (1)					
Description	Supply voltage V	Color of light source	Sold in lots of	Unit reference	Weight kg/lb
Integral LED (to combine with heads for integral LED) 	12 ~ (50/60 Hz)	White	4	ZBVJ15	0.016/0.035
		Green	4	ZBVJ35	0.016/0.035
		Red	4	ZBVJ45	0.016/0.035
		Orange	4	ZBVJ55	0.016/0.035
		Blue	4	ZBVJ65	0.016/0.035
	24 ~ (50/60 Hz)	White	4	ZBVB15	0.016/0.035
		Green	4	ZBVB35	0.016/0.035
		Red	4	ZBVB45	0.016/0.035
		Orange	4	ZBVB55	0.016/0.035
		Blue	4	ZBVB65	0.016/0.035
	110...120 ~ (50/60 Hz)	White	4	ZBVG15	0.016/0.035
		Green	4	ZBVG35	0.016/0.035
		Red	4	ZBVG45	0.016/0.035
		Orange	4	ZBVG55	0.016/0.035
		Blue	4	ZBVG65	0.016/0.035
230...240 ~ (50/60 Hz)	White	4	ZBVM15	0.016/0.035	
	Green	4	ZBVM35	0.016/0.035	
	Red	4	ZBVM45	0.016/0.035	
	Orange	4	ZBVM55	0.016/0.035	
	Blue	4	ZBVM65	0.016/0.035	
Integral LED + body/fixing collar	110...120 ~ (50/60 Hz)	Green	4	ZB4BVG35	0.053/0.117
		Red	4	ZB4BVG45	0.053/0.117

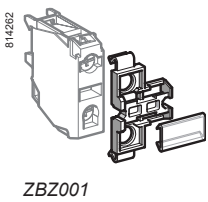
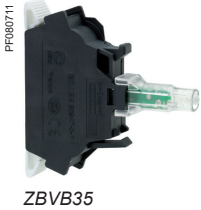

Sheet of 50 blank legends				
For use with	Sold in lots of	Unit reference	Weight kg/lb	
Legend holder ZBZ001	10	ZBY001	0.023/0.051	

(1) It is not possible to fit an additional block on the back of these contact or light blocks.

To combine with heads,
see page 26 to 73

101191



ZB4BZ009

101257

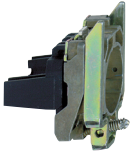

ZB4BZ079 + ZB4BZ009

101303

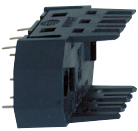

ZBZ01

XB4_632_CPSC11841C



ZBZ110

101259



ZBE701

101260



ZBE702

PF512550



ZBVB07

Body/fixing collar and accessories specifically for printed circuit board mounting ⁽¹⁾

Accessories required when using adaptor (socket) ZBZ010				
Description	For use with	Sold in lots of	Unit reference	Weight kg/lb
Body/fixing collar	Electrical block (contact or light)	10	ZB4BZ009	0.006/0.013
Fixing collar/pillar	Printed circuit board support (fixing screw ZBZ006 to be ordered separately)	10	ZB4BZ079	0.003/0.007
Fixing screw for printed circuit board	Fixing collar/pillar ZB4BZ079	10	ZBZ006	0.011/0.024

Adapter (socket) ⁽¹⁾

For use with	Thickness of printed circuit board (mm)/in.	Sold in lots of	Unit reference	Weight kg/lb
Electrical block (contact or light)	1.6 ± 0.2/0.063 ± 0.008	10	ZBZ010	0.008/0.018
	2.2 ± 0.2/0.087 ± 0.008	10	ZBZ011	0.008/0.018
	3.2 ± 0.2/0.126 ± 0.008	10	ZBZ012	0.008/0.018

Grounding Plate

Description	For use with	Sold in lots of	Unit reference	Weight kg/lb
Grounding plate with ground screw	Harmony XB4 metal and XALG plastic control stations	1	ZBZ110	0.017/0.037

Contact functions ⁽¹⁾

Contacts for standard applications

Description	Type of contact	Circuit symbols		Sold in lots of	Unit reference	Weight kg/lb
		NO	NC			
Contact blocks	Single	1	–	5	ZBE701	0.011/0.024
		–	1	5	ZBE702	0.011/0.024

Contacts for specific applications

Application	Type of contact	Circuit symbols		Sold in lots of	Unit reference	Weight kg/lb
		NO	NC			
Low power switching	Single	1	–	5	ZBE7016	0.012/0.026
		–	1	5	ZBE7026	0.012/0.026

Light blocks ⁽¹⁾

Description	Supply voltage V	Color of LED	Sold in lots of	Unit reference	Weight kg/lb
Integral LED (to combine with heads for integral LED)	24 ~ (50/60 Hz)	White	5	ZBVB17	0.004/0.009
		Green	5	ZBVB37	0.004/0.009
		Red	5	ZBVB47	0.004/0.009
		Orange	5	ZBVB57	0.004/0.009
		Blue	5	ZBVB67	0.004/0.009



Protected LED

⁽¹⁾ For details of support drilling and of printed circuit board, see our website www.schneider-electric.com.



To combine with heads, see page 26 to 73

Contact functions (1)

Faston connectors (6.35 or 2 x 2.8 mm/0.250 or 2 x 0.110 in.) (Schneider Electric anti-loosening system)

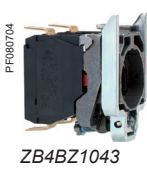
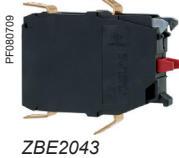
Contacts for standard applications						
Description	Type of contact			Sold in lots of	Unit reference	Weight kg/lb
Contact blocks	Single	1	–	5	ZBE1013	0.011/0.024
		–	1	5	ZBE1023	0.011/0.024
	Double	2	–	5	ZBE2033	0.020/0.044
		–	2	5	ZBE2043	0.020/0.044
		1	1	5	ZBE2053	0.020/0.044
	Single with body/fixing collar	1	–	1	ZB4BZ1013 (2)	0.053/0.117
		–	1	1	ZB4BZ1023 (2)	0.053/0.117
		2	–	1	ZB4BZ1033	0.062/0.137
		–	2	1	ZB4BZ1043	0.062/0.137
		1	1	1	ZB4BZ1053	0.062/0.137



Contacts for specific applications							
Application	Type of contact	Description			Sold in lots of	Unit reference	Weight kg/lb
Low power switching	Single	Standard	1	–	5	ZBE10163 (2)	0.012/0.026
			–	1	5	ZBE10263 (2)	0.012/0.026
		Dusty environments (3) (IP 5X, 50 µm dust)	1	–	5	ZBE1016P3 (2)	0.012/0.026
			–	1	5	ZBE1026P3 (2)	0.012/0.026
Staggered contacts	Single	Early make	1	–	5	ZBE2013 (2)	0.011/0.024
		Late break	–	1	5	ZBE2023 (2)	0.011/0.024
		Standard (4)	1	–	1	ZBE5013	0.021/0.046
High power switching	Single	Standard (4)	–	1	1	ZBE5023	0.021/0.046
			2	–	1	ZBE5033	0.033/0.073
			–	2	1	ZBE5043	0.033/0.073
			1	1	1	ZBE5053	0.033/0.073

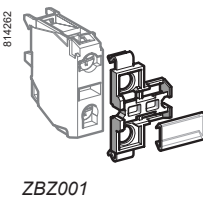
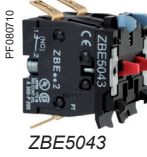

Clip-on legend holder for electrical blocks with screw clamp terminal connections (5)			
For use with	Sold in lots of	Unit reference	Weight kg/lb
Identification of an XB4B control or signaling unit	10	ZBZ001	0.001/0.002
Sheet of 50 blank legends	10	ZBY001	0.023/0.051

(1) The contact blocks enable variable composition of body/contact assemblies. Maximum number of rows possible: 3. Either 3 rows of 3 single contacts or 1 row of 3 double contacts + 1 row of 3 single contacts (double contacts occupy the first 2 rows).

(2) To order products with screw clamp terminal connections for lugs, replace the 3 at the end of the reference with a 9. Example: **ZBE1013** becomes **ZBE1019**.

(3) It is not possible to fit an additional contact block on the back of these contact blocks.

(4) It is not possible to use these contacts with light blocks.

(5) This legend holder is not compatible with high power switching contact blocks.

To combine with heads, see page 26 to 73

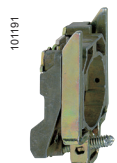

ZB4BZ009

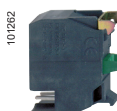

ZBE1014

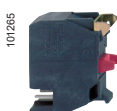

ZBE1024

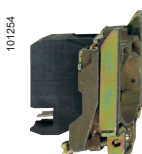

ZB4BZ1014

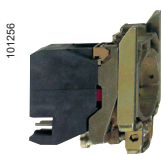

ZB4BZ1024



ZBVB14

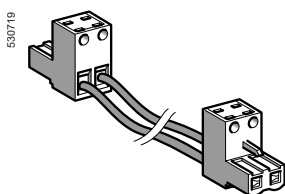

APE1C2250

Body/fixing collar

For use with	Sold in lots of	Unit reference	Weight kg/lb
Electrical block (contact or light)	10	ZB4BZ009	0.038/0.084

Contact functions

Plug-in connector (1)

Contacts for standard applications

Description	Type of contact	NO	NC	Sold in lots of	Unit reference	Weight kg/lb
Contact blocks	Single	1	–	5	ZBE1014	0.011/0.024
		–	1	5	ZBE1024	0.011/0.024
Contact blocks	Single with body/fixing collar	1	–	1	ZB4BZ1014	0.050/0.110
		–	1	1	ZB4BZ1024	0.050/0.110
		2	–	1	ZB4BZ1034	0.058/0.128
		–	2	1	ZB4BZ1044	0.058/0.128
		1	1	1	ZB4BZ1054	0.058/0.128
		1	2	1	ZB4BZ1414	0.064/0.141

Light blocks

Plug-in connector

Description	Supply voltage (V)	Color of light source	Sold in lots of	Unit reference	Weight kg/lb
Integral LED (to combine with heads for integral LED)	24 ~ (50/60 Hz)	White	5	ZBVB14	0.016/0.035
		Green	5	ZBVB34	0.016/0.035
		Red	5	ZBVB44	0.016/0.035
		Orange	5	ZBVB54	0.016/0.035
		Blue	5	ZBVB64	0.016/0.035
Protected LED	110...120 ~ (50/60 Hz)	White	5	ZBVG14	0.016/0.035
		Green	5	ZBVG34	0.016/0.035
		Red	5	ZBVG44	0.016/0.035
		Orange	5	ZBVG54	0.016/0.035
		Blue	5	ZBVG64	0.016/0.035
Protected LED	230...240 ~ (50/60 Hz)	White	5	ZBVM14	0.016/0.035
		Green	5	ZBVM34	0.016/0.035
		Red	5	ZBVM44	0.016/0.035
		Orange	5	ZBVM54	0.016/0.035
		Blue	5	ZBVM64	0.016/0.035

Connecting cables and connector

Description	Number of connectors	Wire c.s.a. mm ² /AWG	Length mm/in.	Sold in lots of	Unit reference	Weight kg/lb
Cables with connectors 2-pin, 5.08 mm/0.200 in. pitch	1	0.75/19	500/19.685	8	APE1C2150	0.120/0.265
	2	0.75/19	500/19.685	8	APE1C2250	0.180/0.397
Spring terminal connector 2-pin, 5.08 mm/0.200 in. pitch	–	0.2 to 0.5/25 to 14	–	10	APE1PRE21	0.003/0.007

(1) It is not possible to fit an additional contact block on the back of these contact blocks.

Control and signaling units

Harmony XB4, metal

Body/contact assemblies + light blocks with integral LED

To combine with:
Heads, see pages 31 to 59
Contacts, see page 76

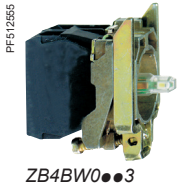

Complete body/contact assemblies and light blocks ⁽¹⁾						
Screw clamp terminal connections (Schneider Electric anti-loosening system)						
Light source	Supply voltage V	Type of contact		Color of light source	Reference	Weight kg/lb
		NO	NC			
Direct supply						
Integral LED	24 ~ (50/60 Hz)	1	-	White	ZB4BW0B11	0.064/0.141
				Green	ZB4BW0B31	0.064/0.141
				Red	ZB4BW0B41	0.064/0.141
				Orange	ZB4BW0B51	0.064/0.141
				Blue	ZB4BW0B61	0.064/0.141
		-	1	White	ZB4BW0B12	0.064/0.141
				Green	ZB4BW0B32	0.064/0.141
				Red	ZB4BW0B42	0.064/0.141
				Orange	ZB4BW0B52	0.064/0.141
				Blue	ZB4BW0B62	0.064/0.141
	2	-	White	ZB4BW0B13	0.074/0.163	
			Green	ZB4BW0B33	0.074/0.163	
			Red	ZB4BW0B43	0.074/0.163	
			Orange	ZB4BW0B53	0.074/0.163	
			Blue	ZB4BW0B63	0.074/0.163	
	1	1	White	ZB4BW0B15	0.074/0.163	
			Green	ZB4BW0B35	0.074/0.163	
			Red	ZB4BW0B45	0.074/0.163	
			Orange	ZB4BW0B55	0.074/0.163	
			Blue	ZB4BW0B65	0.074/0.163	
110...120 ~ (50/60 Hz)	1	-	White	ZB4BW0G11	0.064/0.141	
			Green	ZB4BW0G31	0.064/0.141	
			Red	ZB4BW0G41	0.064/0.141	
			Orange	ZB4BW0G51	0.064/0.141	
			Blue	ZB4BW0G61	0.064/0.141	
	-	1	White	ZB4BW0G12	0.064/0.141	
			Green	ZB4BW0G32	0.064/0.141	
			Red	ZB4BW0G42	0.064/0.141	
			Orange	ZB4BW0G52	0.064/0.141	
			Blue	ZB4BW0G62	0.064/0.141	
2	-	White	ZB4BW0G13	0.074/0.163		
		Green	ZB4BW0G33	0.074/0.163		
		Red	ZB4BW0G43	0.074/0.163		
		Orange	ZB4BW0G53	0.074/0.163		
		Blue	ZB4BW0G63	0.074/0.163		
1	1	White	ZB4BW0G15	0.074/0.163		
		Green	ZB4BW0G35	0.074/0.163		
		Red	ZB4BW0G45	0.074/0.163		
		Orange	ZB4BW0G55	0.074/0.163		
		Blue	ZB4BW0G65	0.074/0.163		

Other versions Complete bodies with Faston connector terminals (6.35 or 2 x 2.8mm/0.250 or 2 x 0.110 in.)
Please contact our Customer Care Center.

(1) Can be fitted with additional contact blocks: see page 76.

To combine with:
 Heads, see pages 31 to 59
 Contacts, see page 76

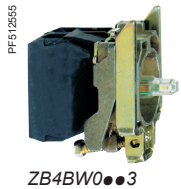

Complete body/contact assemblies and light blocks (continued) (1)						
Screw clamp terminal connections (Schneider Electric anti-loosening system)						
Light source	Supply voltage V	Type of contact		Color of light source	Reference	Weight kg/lb
		NO	NC			
Direct supply (continued)						
Integral LED	230...240 ~ (50/60 Hz)	1	-	White	ZB4BW0M11	0.064/0.141
				Green	ZB4BW0M31	0.064/0.141
				Red	ZB4BW0M41	0.064/0.141
				Orange	ZB4BW0M51	0.064/0.141
				Blue	ZB4BW0M61	0.064/0.141
		-	1	White	ZB4BW0M12	0.064/0.141
				Green	ZB4BW0M32	0.064/0.141
				Red	ZB4BW0M42	0.064/0.141
				Orange	ZB4BW0M52	0.064/0.141
				Blue	ZB4BW0M62	0.064/0.141
		2	-	White	ZB4BW0M13	0.074/0.163
				Green	ZB4BW0M33	0.074/0.163
				Red	ZB4BW0M43	0.074/0.163
				Orange	ZB4BW0M53	0.074/0.163
				Blue	ZB4BW0M63	0.074/0.163
		1	1	White	ZB4BW0M15	0.074/0.163
				Green	ZB4BW0M35	0.074/0.163
				Red	ZB4BW0M45	0.074/0.163
				Orange	ZB4BW0M55	0.074/0.163
				Blue	ZB4BW0M65	0.074/0.163

Other versions Complete bodies with Faston connector terminals (6.35 or 2 x 2.8mm/0.250 or 2 x 0.110 in.). Please contact our Customer Care Center.

(1) Can be fitted with additional contact blocks: see page 76.

Control and signaling units

Harmony XB4, metal

Body/light assemblies for pilot lights with integral LED

To combine with:
Heads, see page 66
Contacts, see page 76

101239



ZB4BV●●

Complete light bodies (fixing collar + light block with integral LED)				
Screw clamp terminal connections (Schneider Electric anti-loosening system)				
Light source	Supply voltage V	Color of light source	Reference	Weight kg/lb
Integral LED protected LED	12 ~ (50/60 Hz)	White	ZB4BVJ1	0.054/0.119
		Green	ZB4BVJ3	0.054/0.119
		Red	ZB4BVJ4	0.054/0.119
		Orange	ZB4BVJ5	0.054/0.119
		Blue	ZB4BVJ6	0.054/0.119
		24 ~ (1) (50/60 Hz)	White	ZB4BVB1
Green	ZB4BVB3		0.054/0.119	
Red	ZB4BVB4		0.054/0.119	
Orange	ZB4BVB5		0.054/0.119	
Blue	ZB4BVB6		0.054/0.119	
24...120 ~ (50/60 Hz)	White	ZB4BVBG1	0.054/0.119	
	Green	ZB4BVBG3	0.054/0.119	
	Red	ZB4BVBG4	0.054/0.119	
	Orange	ZB4BVBG5	0.054/0.119	
	Blue	ZB4BVBG6	0.054/0.119	
110...120 ~ (1) (50/60 Hz)	White	ZB4BVG1	0.054/0.119	
	Green	ZB4BVG3	0.054/0.119	
	Red	ZB4BVG4	0.054/0.119	
	Orange	ZB4BVG5	0.054/0.119	
	Blue	ZB4BVG6	0.054/0.119	
230...240 ~ (1) (50/60 Hz)	White	ZB4BVM1	0.054/0.119	
	Green	ZB4BVM3	0.054/0.119	
	Red	ZB4BVM4	0.054/0.119	
	Orange	ZB4BVM5	0.054/0.119	
	Blue	ZB4BVM6	0.054/0.119	

(1) Complete bodies with Faston connector terminals (6.35 or 2 x 2.8mm/0.250 or 2x 0.110 in.), see page 80.

To combine with:
Heads, see page 66
Contacts, see page 76

PF512556



ZB4BVB●156

Complete light bodies with 3-terminal "test" function

(fixing collar + light block with integral LED + pre-wired block for "test light" function)

Screw clamp terminal connections (Schneider Electric anti-loosening system)

Light source	Supply voltage V	Color of light source	Reference	Weight kg/lb
Integral LED Protected LED	24 \sim (1) (50/60 Hz)	White	ZB4BVB1156	0.054/0.119
		Green	ZB4BVB3156	0.054/0.119
		Red	ZB4BVB4156	0.054/0.119
		Orange	ZB4BVB5156	0.054/0.119
		Blue	ZB4BVB6156	0.054/0.119

Complete bodies with flashing pilot light (fixing collar + light block with integral LED)

Screw clamp terminal connections (Schneider Electric anti-loosening system)

Light source	Supply voltage V	Color of light source	Reference	Weight kg/lb
Integral LED Protected LED	24 \sim (50/60 Hz)	White	ZB4BV18B1	0.054/0.119
		Green	ZB4BV18B3	0.054/0.119
		Red	ZB4BV18B4	0.054/0.119
		Orange	ZB4BV18B5	0.054/0.119
		Blue	ZB4BV18B6	0.054/0.119
	110...120 \sim (50/60 Hz)	White	ZB4BV18G1	0.054/0.119
		Green	ZB4BV18G3	0.054/0.119
		Red	ZB4BV18G4	0.054/0.119
		Orange	ZB4BV18G5	0.054/0.119
		Blue	ZB4BV18G6	0.054/0.119
	230...240 \sim (50/60 Hz)	White	ZB4BV18M1	0.054/0.119
		Green	ZB4BV18M3	0.054/0.119
		Red	ZB4BV18M4	0.054/0.119
		Orange	ZB4BV18M5	0.054/0.119
		Blue	ZB4BV18M6	0.054/0.119

(1) For a 120 or 230 V \sim supply, use complete body ZB4BVG● or ZB4BVM● with block for "test light" function type ZBZM156, see page 84 and 77.

Control and signaling units

Harmony XB4, metal

Body/contact assemblies + light blocks with

BA 9s base fitting

To combine with:
Heads, see page 31
Contacts, see page 76

Complete body/contact assemblies and light blocks ⁽¹⁾							
For bulb with BA 9s base fitting (incandescent, neon or LED)							
Screw clamp terminal connections (Schneider Electric anti-loosening system)							
Light source	Supply voltage V	Type of contact		Color of light source	Reference	Weight kg/lb	
		NO	NC				
Direct supply							
BA9s base fitting bulb, 2.4 W max, not included ⁽²⁾	≤ 250	1	–	–	ZB4BW061	0.063/0.139	
		–	1	–	ZB4BW062	0.063/0.139	
		2	–	–	ZB4BW063	0.073/0.161	
		1	1	–	ZB4BW065	0.073/0.161	
Supply via integral transformer (1.2 VA, 6 V secondary)							
BA9s base fitting incandescent bulb, included	110...120 ~ 50/60 Hz	1	–	–	ZB4BW031	0.141/0.311	
		1	1	–	ZB4BW035	0.151/0.333	
	230 ~ 50 Hz	1	–	–	ZB4BW041	0.141/0.311	
		1	1	–	ZB4BW045	0.151/0.333	
	220...240 ~ 60 Hz	1	–	–	ZB4BW051	0.141/0.311	
		1	1	–	ZB4BW055	0.151/0.333	
	BA9s base fitting LED, included ⁽³⁾	110...120 ~ 50/60 Hz	1	1	White	ZB4BW03D15	0.151/0.333
					Green	ZB4BW03D35	0.151/0.333
					Red	ZB4BW03D45	0.151/0.333
					Orange	ZB4BW03D55	0.151/0.333
					Blue	ZB4BW03D65	0.151/0.333
		230 ~ 50 Hz	1	1	White	ZB4BW04D15	0.151/0.333
Green					ZB4BW04D35	0.151/0.333	
Red					ZB4BW04D45	0.151/0.333	
Orange					ZB4BW04D55	0.151/0.333	
Blue					ZB4BW04D65	0.151/0.333	
220...240 ~ 60 Hz		1	1	White	ZB4BW05D15	0.152/0.335	
				Green	ZB4BW05D35	0.152/0.335	
400 ~ 50/60 Hz	1	1	White	ZB4BW05D45	0.152/0.335		
			Orange	ZB4BW05D55	0.152/0.335		
			Blue	ZB4BW05D65	0.152/0.335		

Other versions Complete bodies with integral transformer incorporating Faston connector terminals (6.35 or 2 x 2.8 mm/0.250 or 2 x 0.110 in.). Please contact our Customer Care Center.

- (1) Can be fitted with additional contact blocks: see page 76.
- (2) Bulb to be ordered separately: see page 110.
- (3) Compatible only with ZB4BW33.

XB4_852_CP0DA016174



ZB4BW06

101239

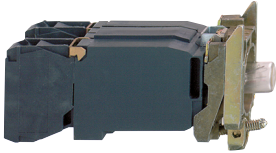

ZB4BW05

To combine with:
 Heads, see [page 67](#)
 Contacts, see [page 76](#)

Light blocks

Screw clamp terminal connections (Schneider Electric anti-loosening system)

Description	Supply voltage V	Sold in lots of	Unit reference	Weight kg/lb
Direct supply for BA 9s base fitting bulb, 2.4 W max., not included (1)	≤ 250	5	ZBV6	0.016/0.035

Complete light bodies (fixing collar + light block)

For bulb with BA 9s base fitting (incandescent, neon or LED)

Screw clamp terminal connections (Schneider Electric anti-loosening system)

Light source	Supply voltage V	Color of light source	Reference	Weight kg/lb
Direct supply				
BA 9s base fitting bulb, 2.4 W max, not included (1)	≤ 250	–	ZB4BV6	0.052/0.335
Supply via integral transformer (1.2 VA, 6 V secondary)				
BA 9s base fitting incandescent bulb, included	110...120 ~ -50/60 Hz	–	ZB4BV3	0.130/0.287
	230 ~ - 50 Hz	–	ZB4BV4	0.130/0.287
	220...240 ~ - 60 Hz	–	ZB4BV5	0.131/0.289
	400 ~ - 50 Hz	–	ZB4BV8	0.128/0.282
	440...480 ~ - 60 Hz	–	ZB4BV9	0.131/0.289

BA 9s base fitting LED, included	110...120 ~ - 50/60 Hz	White	ZB4BV3D1	0.134/0.295
		Green	ZB4BV3D3	0.134/0.295
		Red	ZB4BV3D4	0.134/0.295
		Orange	ZB4BV3D5	0.134/0.295
		Blue	ZB4BV3D6	0.134/0.295
		230 ~ - 50 Hz 220...240 ~ - 60 Hz	White	ZB4BV4D1
	Green		ZB4BV4D3	0.134/0.295
	Red		ZB4BV4D4	0.134/0.295
	Orange		ZB4BV4D5	0.134/0.295
	Blue		ZB4BV4D6	0.134/0.295
	400 ~ - 50/60 Hz		White	ZB4BV5D1
		Green	ZB4BV5D3	0.134/0.295
Red		ZB4BV5D4	0.134/0.295	
Orange		ZB4BV5D5	0.134/0.295	
Blue		ZB4BV5D6	0.134/0.295	

Complete light bodies with 3-terminal "test" function (fixing collar + light block)

For bulb with BA 9s base fitting (incandescent, neon or LED)

Screw clamp terminal connections (Schneider Electric anti-loosening system)

Direct supply				
BA 9s base fitting bulb, 2.4 W max, not included (1)	≤ 250	–	ZB4BV156	0.062/0.137
Other versions	Complete bodies with Faston connector terminals (6.35 or 2 x 2.8 mm/0.250 or 2 x 0.110 in.), see page 80 .			

(1) Bulb to be ordered separately, see [page 110](#).



ZB4BV6

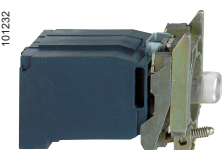

ZB4BV●

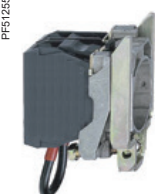

ZB4BV156

Control and signaling units

Harmony XB4 metal

Accessories for heads: caps



ZBA4



ZBL2



ZBA333

Pushbutton caps - unmarked

For use with	Type of push	Color	Sold in lots of	Unit reference	Weight kg/lb
ZBABA0 pushbutton heads supplied without cap	Flush	White	10	ZBA1	0.001/0.002
		Black	10	ZBA2	0.001/0.002
		Green	10	ZBA3	0.001/0.002
		Red	10	ZBA4	0.001/0.002
		Yellow	10	ZBA5	0.001/0.002
		Blue	10	ZBA6	0.001/0.002
	6 colors (1)	1	ZBA9	0.006/0.013	
	Projecting	White	10	ZBL1	0.001/0.002
		Black	10	ZBL2	0.001/0.002
		Green	10	ZBL3	0.001/0.002
		Red	10	ZBL4	0.001/0.002
		Yellow	10	ZBL5	0.001/0.002
		Blue	10	ZBL6	0.001/0.002
6 colors (1)	1	ZBL9	0.006/0.013		

Pushbutton caps - marked

For use with	Type of push	Marking		Color of cap	Unit reference	Weight kg/lb
		Text	Color			
ZBABA0 pushbutton heads supplied without cap (sold in lots of 10)	Flush	I (2)	White	Green	ZBA331	0.001/0.002
			Black	White	ZBA131	0.001/0.002
		II	White	Green	ZBA336	0.001/0.002
			Black	White	ZBA136	0.001/0.002
		III	White	Green	ZBA337	0.001/0.002
			Black	White	ZBA137	0.001/0.002
		IV	White	Green	ZBA338	0.001/0.002
			Black	White	ZBL138	0.001/0.002
		START (2)	White	Green	ZBA333	0.001/0.002
			Black	White	ZBA133	0.001/0.002
		ON	White	Green	ZBA341	0.001/0.002
			Black	White	ZBA141	0.001/0.002
		MARCHE	White	Green	ZBA342	0.001/0.002
			Black	White	ZBA142	0.001/0.002
		UP (2)	Black	White	ZBA343	0.001/0.002
		DOWN (2)	White	Black	ZBA344	0.001/0.002
		⊕ (2)	White	Black	ZBA245	0.001/0.002
			Black	White	ZBA145	0.001/0.002
		↑ (3)	White	Black	ZBA335	0.001/0.002
			Black	White	ZBA334	0.001/0.002
		O (2)	White	Red	ZBA432	0.001/0.002
				Black	ZBA232	0.001/0.002
		ARRET	White	Red	ZBA433	0.001/0.002
				Black	ZBA233	0.001/0.002
		STOP (2)	White	Red	ZBA434	0.001/0.002
				Black	ZBA234	0.001/0.002
		OFF	White	Red	ZBA435	0.001/0.002
				Black	ZBA235	0.001/0.002
		⬇	White	Green	ZBA346	0.001/0.002
		R (2)	White	Blue	ZBA639	0.001/0.002
		+	White	Black	ZBA2934	0.001/0.002
		-	White	Black	ZBA2935	0.001/0.002

(1) Set of 6 different colored caps: white, black, green, red, yellow, and blue.

(2) Double injection moulded marking.

(3) Can be clipped in at 90° steps, through 360°.

Control and signaling units

Harmony XB4, metal

Accessories for flush mounted heads

Pushbutton caps with markings

XB4_633_CP/MF51747



ZBAF331

Pushbutton caps, with markings for flush mounted heads						
For use with	Type of push	Marking		Color of cap	Unit reference	Weight kg/lb
		Text	Color			
Plastic pushbuttons						
ZB4FA0 and ZB5FA0 circular pushbutton heads supplied without cap (sold in lots of 10)	Flush	I (1)	White	Green	ZBAF331	0.001/0.002
			Black	White	ZBAF131	0.001/0.002
		II	White	Green	ZBAF336	0.001/0.002
			Black	White	ZBAF136	0.001/0.002
		III	White	Green	ZBAF337	0.001/0.002
			Black	White	ZBAF137	0.001/0.002
		IV	White	Green	ZBAF338	0.001/0.002
			Black	White	ZBAF138	0.001/0.002
		START (1)	White	Green	ZBAF333	0.001/0.002
			Black	White	ZBAF133	0.001/0.002
		ON	White	Green	ZBAF341	0.001/0.002
			Black	White	ZBAF141	0.001/0.002
		MARCHE	White	Green	ZBAF342	0.001/0.002
			Black	White	ZBAF142	0.001/0.002
		UP (1)	Black	White	ZBAF343	0.001/0.002
		DOWN (1)	White	Black	ZBAF344	0.001/0.002
		Ⓣ (1)	White	Black	ZBAF245	0.001/0.002
			Black	White	ZBAF145	0.001/0.002
		† (2)	White	Black	ZBAF335	0.001/0.002
			Black	White	ZBAF334	0.001/0.002
		O (1)	White	Red	ZBAF432	0.001/0.002
			Black		ZBAF232	0.001/0.002
		ARRET	White	Red	ZBAF433	0.001/0.002
			Black		ZBAF233	0.001/0.002
		STOP (1)	White	Red	ZBAF434	0.001/0.002
			Black		ZBAF234	0.001/0.002
		OFF	White	Red	ZBAF435	0.001/0.002
			Black		ZBAF235	0.001/0.002
		⚠ (1)	White	Green	ZBAF346	0.001/0.002
		R (1)	White	Blue	ZBAF639	0.001/0.002
		+	White	Black	ZBAF2934	0.001/0.002
		-	White	Black	ZBAF2935	0.001/0.002

(1) Double injection moulded marking.

(2) Can be clipped in at 90° steps, through 360°

Control and signaling units

Harmony XB4 metal

Accessories for heads: boots, lens caps

107360



ZBP0

Transparent boots for pushbuttons (1)

Description	For use with XB4 metal pushbuttons	Sold in lots of	Unit reference	Weight kg/lb
Single boots (2)	Flush with circular head	10	ZBPA	0.002/0.004
	Projecting with circular head and push-push version	10	ZBP0	0.002/0.004
	Flush or projecting with circular head for food industry applications	10	ZBP0A	0.002/0.004

Colored boots

Description	Color	For use with	Sold in lots of	Unit reference	Weight kg/lb
Colored boots (can be replaced without dismantling the head)	White	ZB4BP1S	10	ZBP011	0.003/0.007
	Black	ZB4BP2S	10	ZBP012	0.003/0.007
	Green	ZB4BP3S	10	ZBP013	0.003/0.007
	Red	ZB4BP4S	10	ZBP014	0.003/0.007
	Yellow	ZB4BP5S	10	ZBP015	0.003/0.007
	Blue	ZB4BP6S	10	ZBP016	0.003/0.007
Clear membrane	Transparent	ZB4BP●83	10	ZBP017	0.003/0.007

(1) Boots for multiple-headed pushbuttons, see [page 41](#).

(2) Permissible panel thickness 1 to 5 mm/0.039 to 0.197 in., cannot be used with legend holders.

PG113818



ZBV0153

PG113819

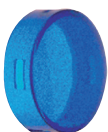

ZBV016

Lens caps				
For use with	Color	Sold in lots of	Unit reference	Weight kg/lb
Lens caps for light sources with integral LED				
Pilot lights	White	10	ZBV0113	0.002/0.004
	Green	10	ZBV0133	0.002/0.004
	Red	10	ZBV0143	0.002/0.004
	Orange	10	ZBV0153	0.002/0.004
	Blue	10	ZBV0163	0.002/0.004
	5 different colored grooved lenses (1)	10	ZBV0103S	0.010/0.022
Illuminated pushbuttons, with flush push	White	10	ZBW9113	0.002/0.004
	Green	10	ZBW9133	0.002/0.004
	Red	10	ZBW9143	0.002/0.004
	Orange	10	ZBW9153	0.002/0.004
	Blue	10	ZBW9163	0.002/0.004
Illuminated pushbuttons, with projecting push	White	10	ZBW9313	0.002/0.004
	Green	10	ZBW9333	0.002/0.004
	Red	10	ZBW9343	0.002/0.004
	Orange	10	ZBW9353	0.002/0.004
	Blue	10	ZBW9363	0.002/0.004
Lens caps for light sources with BA 9s base fitting				
Pilot lights	White	10	ZBV011	0.002/0.004
	Green	10	ZBV013	0.002/0.004
	Red	10	ZBV014	0.002/0.004
	Orange	10	ZBV015	0.002/0.004
	Blue	10	ZBV016	0.002/0.004
	Clear	10	ZBV017	0.002/0.004
Illuminated pushbuttons, with flush push	White	10	ZBW911	0.002/0.004
	Green	10	ZBW913	0.002/0.004
	Red	10	ZBW914	0.002/0.004
	Orange	10	ZBW915	0.002/0.004
	Blue	10	ZBW916	0.002/0.004
	Clear	10	ZBW917	0.002/0.004
Illuminated pushbuttons, with projecting push	White	10	ZBW931	0.002/0.004
	Green	10	ZBW933	0.002/0.004
	Red	10	ZBW934	0.002/0.004
	Orange	10	ZBW935	0.002/0.004
	Blue	10	ZBW936	0.002/0.004
	Clear	10	ZBW937	0.002/0.004

(1) Clear, green, red, orange, or blue.

Control and signaling units

Harmony XB4 metal

8 x 27 mm legends with 30 x 40 mm legend holders

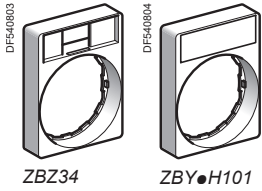

30 x 40 mm legend holders (flush mounting with bezel) for 8 x 27 mm legends (1)						
Description	Legend		Sold in lots of	Unit reference		Weight kg/lb
	Background color	Marking				
Without legend	–	–	10	ZBZ34	–	0.003/0.007
With blank legend	Black or red	–	10	ZBY2H101	–	0.004/0.009
	White or yellow	–	10	ZBY4H101	–	0.004/0.009



Standard 30 x 40 mm legend holders for 8 x 27 mm legends (1)							
Description	Legend		Sold in lots of	Unit reference		Weight kg/lb	
	Color	Marking		For black bezel	For gray bezel (4) (5)		
Without legend	–	–	10	ZBZ32	ZBZ32C0	0.001/0.002	
With blank legend (for engraving)	Black or red	–	10	ZBY2101	ZBY2101C0	0.002/0.004	
	White or yellow	–	10	ZBY4101	ZBY4101C0	0.002/0.004	
With 8 x 27 mm/ 0.315 x 1.063 in. legend (with international marking)	Black or red (2)	O (black background)	10	ZBY2146	–	0.002/0.004	
		O (red background)	10	ZBY2931	–	0.002/0.004	
	Yellow	I	10	ZBY2147	–	0.002/0.004	
		II	10	ZBY2148	–	0.002/0.004	
		O-I	10	ZBY2178	ZBY2178C0	0.002/0.004	
		I-II	10	ZBY2179	–	0.002/0.004	
		I-O-II	10	ZBY2186	ZBY2186C0	0.002/0.004	
		AUTO	10	ZBY2115	–	0.002/0.004	
		STOP	10	ZBY2304	ZBY2304C0	0.002/0.004	
		⚠	10	ZBY4140 (3)	–	0.002/0.004	
	With 8 x 27 mm/ 0.315 x 1.063 in. legend (with French language marking)	Black or red (2)	ARRET (red background)	10	ZBY2104	ZBY2104C0	0.002/0.004
			ARRET (black background)	10	ZBY0104	–	0.002/0.004
	Black or red (2)	ARRET GENERAL	10	ZBY2129	–	0.002/0.004	
		ARRET REARMEMENT	10	ZBY2133	–	0.002/0.004	
		ARRET-MARCHE	10	ZBY2166	ZBY2166C0	0.002/0.004	
		ARRIERE	10	ZBY2106	–	0.002/0.004	
		AUTO CYCLE-CYCLE	10	ZBY2198	–	0.002/0.004	
		AUTO CYCLE-MAIN	10	ZBY2199	–	0.002/0.004	
		AUTO-MAIN	10	ZBY2164	–	0.002/0.004	
		AUTO-O-MAIN	10	ZBY2185	–	0.002/0.004	
		AVANT	10	ZBY2105	–	0.002/0.004	
		AVANT-O-ARRIERE	10	ZBY2184	–	0.002/0.004	
		C-P-C-NORMAL	10	ZBY2165	–	0.002/0.004	
		CYCLE-MAIN	10	ZBY2197	–	0.002/0.004	
		DECLenchement	10	ZBY2132	–	0.002/0.004	
		DEFAULT (black background)	10	ZBY2134	–	0.002/0.004	
		DEFAULT (red background)	10	ZBY2135	–	0.002/0.004	
		DEPART CYCLE	10	ZBY2195	–	0.002/0.004	
		DESCENTE	10	ZBY2108	–	0.002/0.004	
		DROITE	10	ZBY2109	–	0.002/0.004	
		ENCLenchement	10	ZBY2131	–	0.002/0.004	
		EN SERVICE	10	ZBY2111	–	0.002/0.004	
		FERMETURE	10	ZBY2114	–	0.002/0.004	
		GAUCHE	10	ZBY2110	–	0.002/0.004	
		HORS SERVICE	10	ZBY2112	–	0.002/0.004	
		HORS-EN	10	ZBY2167	–	0.002/0.004	
		LENT	10	ZBY2127	–	0.002/0.004	
		MAIN	10	ZBY2116	–	0.002/0.004	
		MARCHE	10	ZBY2103	ZBY2103C0	0.002/0.004	
		MONTEE	10	ZBY2107	–	0.002/0.004	
		Ouverture	10	ZBY2113	–	0.002/0.004	
		PHASE/PHASE	10	ZBY2196	–	0.002/0.004	
		REARMEMENT (red background)	10	ZBY2123	–	0.002/0.004	
		REARMEMENT (black background)	10	ZBY0123	–	0.002/0.004	
SOUS TENSION	10	ZBY2126	–	0.002/0.004			
VITE	10	ZBY2128	–	0.002/0.004			
Red	ARRET D'URGENCE	10	ZBY2130 (3)	–	0.002/0.004		



(1) For legends, see pages 97 to 99.
 (2) "Start" functions: white letters on black background. "Stop" functions: white letters on red background (unless otherwise specified above).
 (3) For compliance with standard EN/ISO 13850, paragraph 4.4.6, the Emergency Stop function logo ⚠ has been added.
 (4) For white color plated bezel replace C0 with C1, and for other color plated bezels using the web customization tool, see page 5.
 (5) To add customized markings on these references using the web customization tool, see page 5.

Control and signaling units

Harmony XB4 metal

8 x 27 mm legends with 30 x 40 mm legend holders

Standard 30 x 40 mm legend holders with 8 x 27 mm legends (continued)						
Description	Legend		Sold in lots of	Reference		Weight kg/lb
	Color	Marking		For black bezel	For gray bezel (3) (4)	
With legend (with English language marking)	Black or red background (1)	AUTO-HAND	10	ZBY2364	–	0.002/0.004
		AUTO-O-HAND	10	ZBY2385	–	0.002/0.004
		CLOSE	10	ZBY2314	–	0.002/0.004
		DOWN	10	ZBY2308	–	0.002/0.004
		FAST	10	ZBY2328	–	0.002/0.004
		FORWARD	10	ZBY2305	–	0.002/0.004
		HAND	10	ZBY2316	–	0.002/0.004
		HAND-OFF-AUTO	10	ZBY2387	–	0.002/0.004
		INCH	10	ZBY2321	–	0.002/0.004
		LEFT	10	ZBY2310	–	0.002/0.004
		OFF	10	ZBY2312	–	0.002/0.004
		OFF-ON	10	ZBY2367	ZBY2367C0	0.002/0.004
		ON	10	ZBY2311	–	0.002/0.004
		OPEN	10	ZBY2313	–	0.002/0.004
		POWER ON	10	ZBY2326	–	0.002/0.004
		RESET (red background)	10	ZBY2323	–	0.002/0.004
		RESET (black background)	10	ZBY2322	–	0.002/0.004
		REVERSE	10	ZBY2306	–	0.002/0.004
		RIGHT	10	ZBY2309	–	0.002/0.004
		RUN	10	ZBY2334	–	0.002/0.004
		SLOW	10	ZBY2327	–	0.002/0.004
		START	10	ZBY2303	ZBY2303C0	0.002/0.004
		STOP-START	10	ZBY2366	–	0.002/0.004
		UP	10	ZBY2307	–	0.002/0.004
With legend (with German language marking)	Red background	EMERGENCY STOP	10	ZBY2330 (2)	–	0.002/0.004
		AB	10	ZBY2208	–	0.002/0.004
		AUF	10	ZBY2207	–	0.002/0.004
		AUS	10	ZBY2204	–	0.002/0.004
		AUS-EIN	10	ZBY2266	–	0.002/0.004
		AUS-IN BETRIEB	10	ZBY2267	–	0.002/0.004
		AUS-RÜCKSTELLUNG	10	ZBY2233	–	0.002/0.004
		AUSSCHALTEN	10	ZBY2232	–	0.002/0.004
		AUTO-HAND	10	ZBY2364	–	0.002/0.004
		AUTO-O-HAND	10	ZBY2385	–	0.002/0.004
		AUTOZYKL-HAND	10	ZBY2299	–	0.002/0.004
		AUTOZYKL- 1 ZYKL	10	ZBY2298	–	0.002/0.004
		C-P-C-NORMAL	10	ZBY2265	–	0.002/0.004
		EIN	10	ZBY2203	–	0.002/0.004
		EINSCHALTEN	10	ZBY2231	–	0.002/0.004
		HAND	10	ZBY2316	–	0.002/0.004
		LANGSAM	10	ZBY2227	–	0.002/0.004
		LINKS	10	ZBY2210	–	0.002/0.004
		NOT-AUS (red background)	10	ZBY2230	–	0.002/0.004
		ÖFFNEN	10	ZBY2213	–	0.002/0.004
		RECHTS	10	ZBY2209	–	0.002/0.004
		RÜCKSTELLUNG	10	ZBY2223	–	0.002/0.004
		SCHLIESSEN	10	ZBY2214	–	0.002/0.004
		SCHNELL	10	ZBY2228	–	0.002/0.004
SPANNUNG EIN	10	ZBY2226	–	0.002/0.004		
STEUERUNG AUS	10	ZBY2212	–	0.002/0.004		
STEUERUNG EIN	10	ZBY2211	–	0.002/0.004		
STÖRUNG (black background)	10	ZBY2234	–	0.002/0.004		
STÖRUNG (red background)	10	ZBY2235	–	0.002/0.004		
VOR	10	ZBY2205	–	0.002/0.004		
VOR-O-ZURÜCK	10	ZBY2284	–	0.002/0.004		
ZURÜCK	10	ZBY2206	–	0.002/0.004		
ZYKLUS-HAND	10	ZBY2297	–	0.002/0.004		
ZYKLUSSTART	10	ZBY2295	–	0.002/0.004		
Red background	NOT-HALT	10	ZBY2229 (2)	–	0.002/0.004	
Yellow background	NOT-HALT	10	ZBY22420001 (2)	–	0.002/0.004	

XB5_CP19007



ZBY2303

XB5_CP19008



ZBY2228

(1) "Start" functions: white letters on black background. "Stop" functions: white letters on red background (unless otherwise specified above).

(2) For compliance with standard EN/ISO 13850, paragraph 4.4.6, the Emergency Stop function logo  has been added.

(3) For white color plated bezel replace C0 with C1, and for other color plated bezels using the web customization tool, see page 5.

(4) To add customized markings on these references using the web customization tool, see page 5.

XB5_CP19019



ZBYP2101

XB5_CP19023



ZBYM2303

Standard 30 x 40 mm legend plates

Description	Marking (3)	Sold in lots of	Unit Reference		Weight kg/lb
			For black bezel	For gray bezel (1) (2)	
Legend plate, plastic	-	10	ZBYP2101	ZBYP2101C0	0.001/0.002
	O-I	10	ZBYP2178	ZBYP2178C0	0.001/0.002
	STOP	10	ZBYP2304	ZBYP2304C0	0.001/0.002
	START	10	ZBYP2303	ZBYP2303C0	0.001/0.002
	MARCHE	10	ZBYP2103	ZBYP2103C0	0.001/0.002
	I-O-II	10	ZBYP2186	ZBYP2186C0	0.001/0.002
	OFF-ON	10	ZBYP2367	ZBYP2367C0	0.001/0.002
	ARRET-MARCHE	10	ZBYP2166	ZBYP2166C0	0.001/0.002
	ARRET	10	ZBYP2104	ZBYP2104C0	0.001/0.002
Legend plate, metal	-	10	ZBYM2101	-	0.004/0.009
	O-I	10	ZBYM2178	-	0.004/0.009
	STOP	10	ZBYM2304	-	0.004/0.009
	START	10	ZBYM2303	-	0.004/0.009
	MARCHE	10	ZBYM2103	-	0.004/0.009
	I-O-II	10	ZBYM2186	-	0.004/0.009
	OFF-ON	10	ZBYM2367	-	0.004/0.009
	ARRET-MARCHE	10	ZBYM2166	-	0.004/0.009
	ARRET	10	ZBYM2104	-	0.004/0.009

(1) For white color plated bezel replace C0 by C1, and for other color plated bezel through web customization tool, see [page 5](#).

(2) To add customized markings on these references through web customization tool, see [page 5](#).

(3) Black marking for metal references, white marking for standard references.

8 x 27 mm marked legends for 30 x 40 mm legend holders ZBZ32 and ZBZ34						
Language	Background color	Marking	Sold in lots of	Reference	Weight kg/lb	
Without	Black or red	–	10	ZBY0101 (3)	0.001/0.002	
	White or yellow	–	10	ZBY0102 (3)	0.001/0.002	
International	Black or red (1)	O (black background)	10	ZBY02146	0.001/0.002	
		O (red background)	10	ZBY02931	0.001/0.002	
		I	10	ZBY02147	0.001/0.002	
		II	10	ZBY02148	0.001/0.002	
		O-I	10	ZBY02178	0.001/0.002	
		I-II	10	ZBY02179	0.001/0.002	
		I-O-II	10	ZBY02186	0.001/0.002	
		AUTO	10	ZBY02115	0.001/0.002	
		STOP	10	ZBY02304	0.001/0.002	
		Yellow		10	ZBY0140 (2)	0.001/0.002
	French	Black or red (1)	ARRET (red background)	10	ZBY02104	0.001/0.002
			ARRET (black background)	10	ZBY00104	0.001/0.002
			ARRET GENERAL	10	ZBY02129	0.001/0.002
ARRET REARMEMENT			10	ZBY02133	0.001/0.002	
ARRET-MARCHE			10	ZBY02166	0.001/0.002	
ARRIERE			10	ZBY02106	0.001/0.002	
AUTO CYCLE-CYCLE			10	ZBY02198	0.001/0.002	
AUTO CYCLE-MAIN			10	ZBY02199	0.001/0.002	
AUTO-MAIN			10	ZBY02164	0.001/0.002	
AUTO-O-MAIN			10	ZBY02185	0.001/0.002	
AVANT			10	ZBY02105	0.001/0.002	
AVANT-O-ARRIERE			10	ZBY02184	0.001/0.002	
C-P-C-NORMAL			10	ZBY02165	0.001/0.002	
CYCLE-MAIN			10	ZBY02197	0.001/0.002	
DECLENCHEMENT			10	ZBY02132	0.001/0.002	
DEFAUT (black background)			10	ZBY02134	0.001/0.002	
DEFAUT (red background)			10	ZBY02135	0.001/0.002	
DEPART CYCLE			10	ZBY02195	0.001/0.002	
DESCENTE			10	ZBY02108	0.001/0.002	
DROITE			10	ZBY02109	0.001/0.002	
ENCLENCHEMENT			10	ZBY02131	0.001/0.002	
EN SERVICE			10	ZBY02111	0.001/0.002	
FERMETURE			10	ZBY02114	0.001/0.002	
GAUCHE			10	ZBY02110	0.001/0.002	
HORS SERVICE			10	ZBY02112	0.001/0.002	
HORS-EN			10	ZBY02167	0.001/0.002	
LENT			10	ZBY02127	0.001/0.002	
MAIN			10	ZBY02116	0.001/0.002	
MARCHE			10	ZBY02103	0.001/0.002	
MONTEE			10	ZBY02107	0.001/0.002	
OUVERTURE			10	ZBY02113	0.001/0.002	
PHASE/PHASE			10	ZBY02196	0.001/0.002	
REARMEMENT (red background)			10	ZBY02123	0.001/0.002	
REARMEMENT (black background)	10	ZBY00123	0.001/0.002			
SOUS TENSION	10	ZBY02126	0.001/0.002			
VITE	10	ZBY02128	0.001/0.002			
Red	ARRET D'URGENCE	10	ZBY02130 (2)	0.001/0.002		

(1) "Start" functions: white letters on black background. "Stop" functions: white letters on red background (unless otherwise specified above)

(2) For compliance with standard EN/ISO 13850, paragraph 4.4.6, the Emergency Stop function logo  has been added.

(3) To add customized markings on these references using the web customization tool, see [page 5](#).

DG121279

START

ZBY02303

8 x 27 mm marked legends (for 30 x 40 mm legend holders ZBZ32 and ZBZ34) (3)
(continued)

Language	Background color	Marking	Sold in lots of	Unit reference	Weight kg/lb		
English	Black or red (1)	AUTO-HAND	10	ZBY02364	0.001/0.002		
		AUTO-O-HAND	10	ZBY02385	0.001/0.002		
		CLOSE	10	ZBY02314	0.001/0.002		
		DOWN	10	ZBY02308	0.001/0.002		
		FAST	10	ZBY02328	0.001/0.002		
		FORWARD	10	ZBY02305	0.001/0.002		
		HAND	10	ZBY02316	0.001/0.002		
		HAND-OFF-AUTO	10	ZBY02387	0.001/0.002		
		INCH	10	ZBY02321	0.001/0.002		
		LEFT	10	ZBY02310	0.001/0.002		
		OFF	10	ZBY02312	0.001/0.002		
		OFF-ON	10	ZBY02367	0.001/0.002		
		ON	10	ZBY02311	0.001/0.002		
		OPEN	10	ZBY02313	0.001/0.002		
		POWER ON	10	ZBY02326	0.001/0.002		
		RESET (red background)	10	ZBY02323	0.001/0.002		
		RESET (black background)	10	ZBY02322	0.001/0.002		
		REVERSE	10	ZBY02306	0.001/0.002		
		RIGHT	10	ZBY02309	0.001/0.002		
		RUN	10	ZBY02334	0.001/0.002		
		SLOW	10	ZBY02327	0.001/0.002		
		START	10	ZBY02303	0.001/0.002		
		STOP-START	10	ZBY02366	0.001/0.002		
		UP	10	ZBY02307	0.001/0.002		
		Red		EMERGENCY STOP	10	ZBY02330 (2)	0.001/0.002

(1) "Start" functions: white letters on black background. "Stop" functions: white letters on red background (unless otherwise specified above).

(2) For compliance with standard EN/ISO 13850, paragraph 4.4.6, the Emergency Stop function logo  has been added.

(3) To add customized markings on these references using the web customization tool, see [page 5](#).

Control and signaling units

Harmony XB4 metal

Legends 8 x 27 mm

DG 121264

SCHNELL

ZBY02228

8 x 27 mm marked legends (for 30 x 40 mm legend holders ZBZ32 and ZBZ34) (continued) (3)					
Language	Background color	Marking	Sold in lots of	Unit reference	Weight kg/lb
German	Black or red (1)	AB	10	ZBY02208	0.001/0.002
		AUF	10	ZBY02207	0.001/0.002
		AUS	10	ZBY02204	0.001/0.002
		AUS-EIN	10	ZBY02266	0.001/0.002
		AUS-IN BETRIEB	10	ZBY02267	0.001/0.002
		AUS-RÜCKSTELLUNG	10	ZBY02233	0.001/0.002
		AUSSCHALTEN	10	ZBY02232	0.001/0.002
		AUTO-HAND	10	ZBY02364	0.001/0.002
		AUTO-O-HAND	10	ZBY02385	0.001/0.002
		AUTOZYKL-HAND	10	ZBY02299	0.001/0.002
		AUTOZYKL- 1 ZYKL	10	ZBY02298	0.001/0.002
		C-P-C-NORMAL	10	ZBY02265	0.001/0.002
		EIN	10	ZBY02203	0.001/0.002
		EINSCHALTEN	10	ZBY02231	0.001/0.002
		HAND	10	ZBY02316	0.001/0.002
		LANGSAM	10	ZBY02227	0.001/0.002
		LINKS	10	ZBY02210	0.001/0.002
		NOT-AUS (red background)	10	ZBY02230	0.001/0.002
		ÖFFNEN	10	ZBY02213	0.001/0.002
		RECHTS	10	ZBY02209	0.001/0.002
		RÜCKSTELLUNG	10	ZBY02223	0.001/0.002
		SCHLIESSEN	10	ZBY02214	0.001/0.002
		SCHNELL	10	ZBY02228	0.001/0.002
		SPANNUNG EIN	10	ZBY02226	0.001/0.002
		STEUERUNG AUS	10	ZBY02212	0.001/0.002
		STEUERUNG EIN	10	ZBY02211	0.001/0.002
		STÖRUNG (black background)	10	ZBY02234	0.001/0.002
		STÖRUNG (red background)	10	ZBY02235	0.001/0.002
		VOR	10	ZBY02205	0.001/0.002
		VOR-O-ZURÜCK	10	ZBY02284	0.001/0.002
		ZURÜCK	10	ZBY02206	0.001/0.002
		ZYKLUS-HAND	10	ZBY02297	0.001/0.002
ZYKLUSSTART	10	ZBY02295	0.001/0.002		
Red		NOT-HALT	10	ZBY02229 (2)	0.001/0.002
Yellow		NOT-HALT	10	ZBY022420001 (2)	0.001/0.002

814309

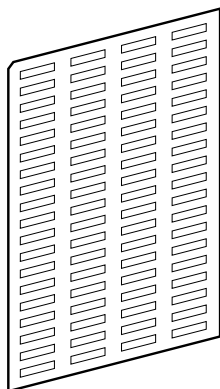

ZBY4100

Sheets of peel-off legends (with backing board and protective transparent cover)				
Description	For use with	Sold in lots of	Unit reference	Weight kg/lb
Sheet of 76 legends Ø 8 x 27 mm/ 0.315 x 1.063 in.	Ø 30 x 40 mm/1.181 x 1.575 in. legend holder ZBZ32 and ZBZ34	10	ZBY4100	0.043/0.095

(1) "Start" functions: white letters on black background. "Stop" functions: white letters on red background (unless otherwise specified above).

(2) For compliance with standard EN/ISO 13850, paragraph 4.4.6, the Emergency Stop function logo  has been added.

(3) To add customized markings on these references using the web customization tool, see [page 5](#).

Control and signaling units

Harmony XB4 metal

Legend holders for 18 x 27 mm legends

18 x 27 mm legends for engraving

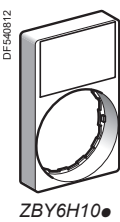
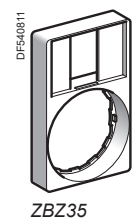
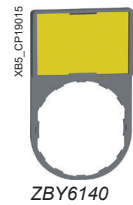
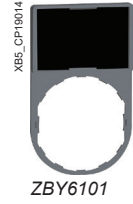

Standard 30 x 50 mm legend holders for 18 x 27 mm legends (2)					
Description	Background color	Sold in lots of	Unit reference		Weight kg/lb
			For black bezel	For gray bezel (3)	
Without legend	–	10	ZBZ33	ZBZ33C0	0.001/0.002
With blank legend	Black or red	10	ZBY6101	ZBY6101C0	0.002/0.004
	White or yellow	10	ZBY6102	ZBY6102C0	0.002/0.004
	Yellow	10	ZBY6140 (1)	–	0.002/0.004

30 x 50 mm legend holder (flush mounting with bezel) for 18 x 27 mm legends					
Description	Background color	Sold in lots of	Unit reference		Weight kg/lb
			For black bezel	For gray bezel (3)	
Without legend	–	10	ZBZ35	–	0.003/0.007
With blank legend	Black or red	10	ZBY6H101	–	0.004/0.009
	White or yellow	10	ZBY6H102	–	0.004/0.009

30 x 50 mm legend plates					
Description		Sold in lots of	Unit reference		Weight kg/lb
			For black bezel	For gray bezel (3)	
Legend plate, plastic (2)		10	ZBYP6101	ZBYP6101C0	0.001/0.002
Legend plate, metal		10	ZBYM6101	–	0.006/0.013

18 x 27 mm legends for engraving for 30 x 50 mm legend holders						
Description	Language	Marking	Sold in lots of	Unit reference		Weight kg/lb
				For black bezel	For gray bezel (3)	
Black or red background	–	Without	10	ZBY5101	–	0.001/0.002
White or yellow background	–	Without	10	ZBY5102	–	0.001/0.002
Yellow background	International		10	ZBY5140 (1)	–	0.001/0.002
	French	ARRET D'URGENCE	10	ZBY55130 (1)	–	0.001/0.002
	English	EMERGENCY STOP	10	ZBY55330 (1)	–	0.001/0.002

18 x 27 mm legends for engraving for 30 x 50 mm legend holders					
Description	For use with	Sold in lots of	Unit reference		Weight kg/lb
			For black bezel	For gray bezel (3)	
Sheet of 40 18 x 27 mm/ 0.709 x 1.063 in. legends	30 x 50 mm/ 1.181 x 1.968 in. legend holder ZBZ33 and ZBZ35	10	ZBY5100	–	0.044/0.097

(1) For compliance with standard EN/ISO 13850, paragraph 4.4.6, the Emergency Stop function logo has been added.

(2) For white color plated bezel replace C0 with C1, and for other color plated bezels using the web customization tool, see page 5.

(3) To add customized markings on these references using the web customization tool, see page 5.

Control and signaling units

Harmony XB4 metal

Legend holders for flush mounted heads

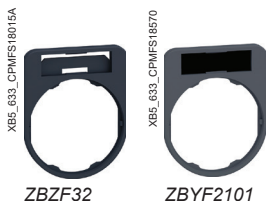

Standard 40 x 50 mm legend holders for 8 x 27 mm legends - for flush mounted heads						
Description	Color	Sold in lots of	Unit reference		Weight kg/lb	
			For black bezel	For gray bezel (2)(3)		
Without legend	–	10	ZBZF32	–	0.001/0.002	
With blank legend (for engraving)	Black or red	10	ZBYF2101	ZBYF2101C0	0.002/0.004	
	White or yellow	10	ZBYF4101	ZBYF4101C0	0.002/0.004	
With 8 x 27 mm/ 0.315 x 1.063 in. legend (with international marking)	Black or red (1)	O-I	10	ZBYF2178	ZBYF2178C0	0.003/0.007
		STOP	10	ZBYF2304	ZBYF2304C0	0.003/0.007
		START (in white)	10	ZBYF2303	ZBYF2303C0	0.003/0.007
		MARCHE	10	ZBYF2103	ZBYF2103C0	0.003/0.007
		I-O-II	10	ZBYF2186	ZBYF2186C0	0.003/0.007
		OFF-ON	10	ZBYF2367	ZBYF2367C0	0.003/0.007
		ARRET-MARCHE	10	ZBYF2166	ZBYF2166C0	0.003/0.007

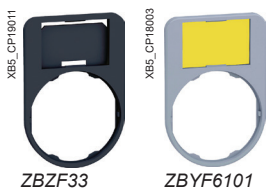

Standard 40 x 60 mm legend holders for 18 x 27 mm legends - for flush mounted heads					
Description	Color	Sold in lots of	Unit reference		Weight kg/lb
			For black bezel	For gray bezel (2)(3)	
Without legend	–	10	ZBZF33	–	0.001/0.002
With blank legend (for engraving)	Black or red	10	ZBYF6101	ZBYF6101C0	0.002/0.004
	White or yellow	10	ZBYF6102	ZBYF6102C0	0.002/0.004



Standard 40 x 50 mm legend plate - for flush mounted heads						
Description	Color	Marking (4)	Sold in lots of	Unit reference		Weight kg/lb
				For black bezel	For gray bezel (2)(3)	
Legend plate, plastic	–	–	10	ZBYFP2101	ZBYFP2101C0	0.003/0.007
		O-I	10	ZBYFP2178	ZBYFP2178C0	0.003/0.007
		STOP	10	ZBYFP2304	ZBYFP2304C0	0.003/0.007
		START	10	ZBYFP2303	ZBYFP2303C0	0.003/0.007
		MARCHE	10	ZBYFP2103	ZBYFP2103C0	0.003/0.007
		I-O-II	10	ZBYFP2186	ZBYFP2186C0	0.003/0.007
		OFF-ON	10	ZBYFP2367	ZBYFP2367C0	0.003/0.007
		ARRET-MARCHE	10	ZBYFP2166	ZBYFP2166C0	0.003/0.007
		ARRET	10	ZBYFP2104	ZBYFP2104C0	0.003/0.007

40 x 60 mm legend plate - for flush mounted heads						
Description	Color	Marking	Sold in lots of	Unit Reference		Weight kg/lb
				For black bezel	For gray bezel (2)(3)	
Legend plate, plastic	–	–	10	ZBYFP6101	ZBYFP6101C0	0.003/0.007

(1) "Start" functions: white letters on black background. "Stop" functions: white letters on red background (unless otherwise specified above).

(2) For white color plated bezel replace C0 with C1, and for other color plated bezels using the web customization tool, see page 5.

(3) To add customized markings on these references using the web customization tool, see page 5.

(4) Black marking for white color plated, white marking for black and gray color plated.

Control and signaling units

Harmony XB4 metal

Legends for insertion, printing, or pre-printed, circular
Bellows for harsh environments

DF540813

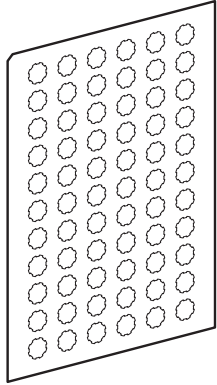

ZBY1101

Legends for XB5A pushbuttons, illuminated pushbuttons, and pilot lights

Description	Language	Marking	Sold in lots of	Unit reference	Weight kg/lb
Sheets of 66 circular peel-off, transparent, self-adhesive legends	–	Without	10	ZBY1101	0.017/0.037
Strips of 66 circular peel-off, transparent, self-adhesive legends	International	O	10	ZBY1146	0.017/0.037
		I	10	ZBY1147	0.017/0.037
		II	10	ZBY1148	0.017/0.037
		III	10	ZBY1149	0.017/0.037
		STOP	10	ZBY1304	0.017/0.037
		↑	10	ZBY1912	0.017/0.037
	French	ARRET	10	ZBY1104	0.017/0.037
		ARRIERE	10	ZBY1106	0.017/0.037
		AUTO	10	ZBY1115	0.017/0.037
		AVANT	10	ZBY1105	0.017/0.037
DESCENTE		10	ZBY1108	0.017/0.037	
MAIN		10	ZBY1116	0.017/0.037	
MARCHE		10	ZBY1103	0.017/0.037	
MONTEE		10	ZBY1107	0.017/0.037	
English	HAND	10	ZBY1316	0.017/0.037	
	OFF	10	ZBY1312	0.017/0.037	
	ON	10	ZBY1311	0.017/0.037	
	START	10	ZBY1303	0.017/0.037	
German	AB	10	ZBY1208	0.017/0.037	
	AUF	10	ZBY1207	0.017/0.037	
	AUS	10	ZBY1204	0.017/0.037	
	EIN	10	ZBY1203	0.017/0.037	
	ZU	10	ZBY1214	0.017/0.037	

Bellows for harsh environments

Description	Material	Color	Sold in lots of	Reference	Weight kg/lb
Environments subject to humidity, dust, high-pressure cleaning, etc.	Silicone	Red	2	ZBZ48	0.009/0.020

107361



ZBZ48

Control and signaling units

Harmony XB4 metal

Illuminated rings and circular yellow legends for mushroom head pushbuttons

Illuminated rings for mushroom head pushbuttons (1)

Description	Marking	Signaling	Supply voltage	Color	Sold in lots of	Reference	Weight kg/lb
Ø 60 mm/2.362 in. illuminated ring	-	Fixed, red	24 V ~	Yellow	1	ZBY9W2B101	0.031/0.068
	-	Fixed, red	120 V ~	Yellow	1	ZBY9W2G101	0.031/0.068
	-	Fixed, red	230 V ~	Yellow	1	ZBY9W2M101	0.031/0.068
	-	Fixed, red + white	24 V ~	Yellow	1	ZBY9W3B101	0.031/0.068

Circular yellow legends for mushroom head pushbuttons

Used for "Emergency stop" function (1)

Diameter mm/in.	Conforming to standards	Marking on yellow background	Sold in lots of	Reference	Weight kg/lb
60/2.363	EN/IEC 60204-1	-	5	ZBY9121	0.007/0.015
		EMERGENCY STOP	5	ZBY9320	0.007/0.015
		ARRET D'URGENCE	5	ZBY9120	0.007/0.015
		NOT-HALT	5	ZBY9220	0.007/0.015
		PARADA DE EMERGENCIA	5	ZBY9420	0.007/0.015
		ARRESTO DI EMERGENZA	5	ZBY9620	0.007/0.015
90/3.543	EN/IEC 60204-1 and EN/ISO 13850	-	10	ZBY8140	0.008/0.018
		ARRET D'URGENCE	10	ZBY8130	0.008/0.018
		EMERGENCY STOP	10	ZBY8330	0.008/0.018
		NOT-HALT	10	ZBY8230	0.008/0.018
		PARADA DE EMERGENCIA	10	ZBY8430	0.008/0.018
		ARRESTO DE EMERGENZA	10	ZBY8630	0.008/0.018

Used for "Emergency switching off" function

60/2.362	EN/IEC 60204-1	-	10	ZBY9101	0.004/0.009
		COUPURE D'URGENCE	10	ZBY9160	0.004/0.009
		EMERGENCY SWITCHING OFF	10	ZBY9360	0.004/0.009
		NOT-AUS	10	ZBY9260	0.004/0.009
		DESCONEXION DE EMERGENCIA	10	ZBY9460	0.004/0.009
		INTERRUZIONE DI EMERGENZA	10	ZBY9660	0.004/0.009
90/3.543	EN/IEC 60204-1	-	10	ZBY8101	0.008/0.018
		COUPURE D'URGENCE	10	ZBY8160	0.008/0.018
		EMERGENCY SWITCHING OFF	10	ZBY8360	0.008/0.018
		NOT-AUS	10	ZBY8260	0.008/0.018
		DESCONEXION DE EMERGENCIA	10	ZBY8460	0.008/0.018
		INTERRUZIONE DI EMERGENZA	10	ZBY8660	0.008/0.018

(1) For compliance with standard EN/ISO 13850, paragraph 4.4.6, the Emergency Stop function logo  has been added.

PF131020



ZBY9320

XB4_032_CPF_UR10301



ZBY9360

Control and signaling units

Harmony XB4 metal

Legends panel

XB4_632_CPSVA18028

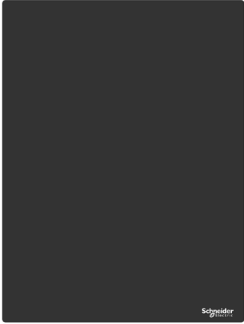

ZBYLEG304000

ZBYLEG201001

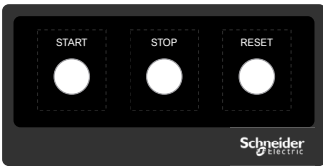

ZBYLEG201001

XB4_632_CPSVA18028



ZBYLEG304001

XB4_632_CPSVA18028



ZBYLEG503001

Legends panel (1)

Template size mm/in.	Unit reference	Weight kg/lb
Unmarked templates		
100 x 100/3.93 x 3.93	ZBYLEG101000	0.010/0.022
200 x 100/7.87 x 3.93	ZBYLEG201000	0.010/0.022
300 x 100/11.81 x 3.93	ZBYLEG301000	0.010/0.022
300 x 200/11.81 x 7.87	ZBYLEG302000	0.030/0.066
300 x 300/11.81 x 11.81	ZBYLEG303000	0.030/0.066
300 x 400/11.81 x 15.74	ZBYLEG304000	0.030/0.066
400 x 100/15.74 x 3.93	ZBYLEG401000	0.010/0.022
400 x 200/15.74 x 7.87	ZBYLEG402000	0.050/0.110
500 x 100/19.68 x 3.93	ZBYLEG501000	0.030/0.066
500 x 200/19.68 x 7.87	ZBYLEG502000	0.050/0.110
500 x 300/19.68 x 11.81	ZBYLEG503000	0.050/0.110
500 x 400/19.68 x 15.74	ZBYLEG504000	0.050/0.110
Marked templates		
100 x 100/3.93 x 3.93	ZBYLEG101001	0.010/0.022
200 x 100/7.87 x 3.93	ZBYLEG201001	0.010/0.022
300 x 100/11.81 x 3.93	ZBYLEG301001	0.010/0.022
300 x 200/11.81 x 7.87	ZBYLEG302001	0.030/0.066
300 x 300/11.81 x 11.81	ZBYLEG303001	0.030/0.066
300 x 400/11.81 x 15.74	ZBYLEG304001	0.030/0.066
400 x 100/15.74 x 3.93	ZBYLEG401001	0.010/0.022
400 x 200/15.74 x 7.87	ZBYLEG402001	0.050/0.110
500 x 100/19.68 x 3.93	ZBYLEG501001	0.030/0.066
500 x 200/19.68 x 7.87	ZBYLEG502001	0.050/0.110
500 x 300/19.68 x 11.81	ZBYLEG503001	0.050/0.110
500 x 400/19.68 x 15.74	ZBYLEG504001	0.050/0.110

(1) To add customized markings on these references using the web customization tool, see [page 5](#)

Control and signaling units

Harmony XB4 metal

Illuminated rings for Emergency stop

XB4_632_CPS(VA)18028



ZBY9W2B330

Illuminated rings for Emergency stop (1)							
Description	Marking	Signaling	Supply voltage	Color	Sold in lots of	Reference	Weight kg/lb
Ø 60 mm/2.362 in. illuminated ring for Emergency stop	EMERGENCY STOP	Fixed, red	24 V ~	Yellow	1	ZBY9W2B330	0.031/0.068
	ARRET D'URGENCE	Fixed, red	24 V ~	Yellow	1	ZBY9W2B130	0.031/0.068
	NOT HALT	Fixed, red	24 V ~	Yellow	1	ZBY9W2B230	0.031/0.068
	PARADA DE EMERGENCIA	Fixed, red	24 V ~	Yellow	1	ZBY9W2B430	0.031/0.068
	ARRESTO DI EMERGENZA	Fixed, red	24 V ~	Yellow	1	ZBY9W2B630	0.031/0.068
	-	Fixed, red	24 V ~	Yellow	1	ZBY9W2B140	0.031/0.068
	EMERGENCY STOP	Fixed, red	120 V ~	Yellow	1	ZBY9W2G330	0.031/0.068
	ARRET D'URGENCE	Fixed, red	120 V ~	Yellow	1	ZBY9W2G130	0.031/0.068
	NOT HALT	Fixed, red	120 V ~	Yellow	1	ZBY9W2G230	0.031/0.068
	PARADA DE EMERGENCIA	Fixed, red	120 V ~	Yellow	1	ZBY9W2G430	0.031/0.068
	ARRESTO DI EMERGENZA	Fixed, red	120 V ~	Yellow	1	ZBY9W2G630	0.031/0.068
	-	Fixed, red	120 V ~	Yellow	1	ZBY9W2G140	0.031/0.068
	EMERGENCY STOP	Fixed, red	230 V ~	Yellow	1	ZBY9W2M330	0.031/0.068
	ARRET D'URGENCE	Fixed, red	230 V ~	Yellow	1	ZBY9W2M130	0.031/0.068
	NOT HALT	Fixed, red	230 V ~	Yellow	1	ZBY9W2M230	0.031/0.068
	PARADA DE EMERGENCIA	Fixed, red	230 V ~	Yellow	1	ZBY9W2M430	0.031/0.068
	ARRESTO DI EMERGENZA	Fixed, red	230 V ~	Yellow	1	ZBY9W2M630	0.031/0.068
	-	Fixed, red	230 V ~	Yellow	1	ZBY9W2M140	0.031/0.068
	EMERGENCY STOP	Fixed, red + white	24 V ~	Yellow	1	ZBY9W3B330	0.031/0.068
ARRET D'URGENCE	Fixed, red + white	24 V ~	Yellow	1	ZBY9W3B130	0.031/0.068	
NOT HALT	Fixed, red + white	24 V ~	Yellow	1	ZBY9W3B230	0.031/0.068	
PARADA DE EMERGENCIA	Fixed, red + white	24 V ~	Yellow	1	ZBY9W3B430	0.031/0.068	
ARRESTO DI EMERGENZA	Fixed, red + white	24 V ~	Yellow	1	ZBY9W3B630	0.031/0.068	
-	Fixed, red + white	24 V ~	Yellow	1	ZBY9W3B140	0.031/0.068	

(1) For compliance with standard EN/ISO 13850, paragraph 4.4.6, the Emergency Stop function logo  has been added.

XB4_632_CPS(VA)18028



ZBY9W3B140

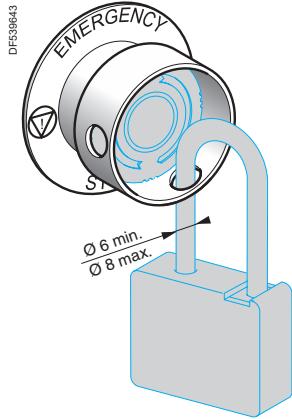

ZBZ3605



ZBY9330T



ZBY9360T

Accessories for mushroom head pushbuttons

Description	Exclusive use with the following Ø 40 mm/1.575 in. trigger action pushbuttons	Color	Reference	Weight kg/lb
Padlocking kit (1) (2) For Emergency stop (3) and Emergency switching off function (4), (padlockable)	XB4BS844● XB4BS9445 ZB4BS844 ZB4BS944●	Yellow	ZBZ3605	0.045/0.099

Description	Marking	Color	Sold in lots of	Reference	Weight kg/lb
Ø 60 mm/2.362 in. legend for padlocking device ZBZ3605 For Emergency stop function (3)	Without	Yellow	10	ZBY9140T	0.004/0.009
	ARRET D'URGENCE	Yellow	10	ZBY9130T	0.004/0.009
	EMERGENCY STOP	Yellow	10	ZBY9330T	0.004/0.009
	NOT-HALT	Yellow	10	ZBY9230T	0.004/0.009
Ø 60 mm/2.362 in. legend for padlocking device ZBY9360T For Emergency switching off function (4)	Without	Yellow	10	ZBY9101T	0.004/0.009
	COUPURE D'URGENCE	Yellow	10	ZBY9160T	0.004/0.009
	EMERGENCY SWITCHING OFF	Yellow	10	ZBY9360T	0.004/0.009
	NOT-AUS	Yellow	10	ZBY9260T	0.004/0.009

- (1) Standard circular legends are not compatible with this product. Use special legends ZBY9●●●T.
- (2) No isolation function is possible when this guard is fitted.
- (3) For conformity with standards EN/IEC 60204-1 and EN/ISO 13850.
- (4) For conformity with standard EN/IEC 60204-1.

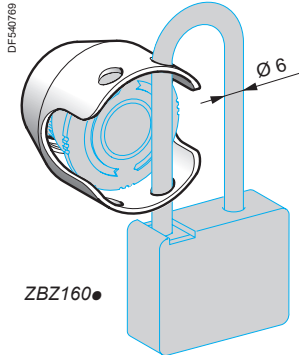

Accessories for mushroom head pushbuttons

Description	Exclusive use with the following Ø 40 mm/1.575 in. trigger action pushbuttons	Color	Reference	Weight kg/lb
Metal guards For Emergency stop and Emergency switching off function Padlockable (1)	XB4BT8● XB4BS8● XB4BS9● ZB4BT8● ZB4BS8● ZB4BS9●	Chromium plated	ZBZ1600	0.046/0.101
		Black	ZBZ1602	0.046/0.101
		Red	ZBZ1604	0.046/0.101
		Yellow	ZBZ1605	0.046/0.101
		Blue	ZBZ1606	0.046/0.101



Circular yellow legends for metal guard ZBZ160●

Description	Marking	Color	Sold in lots of	Reference	Weight kg/lb
For Emergency stop function					
Ø 60 mm/2.362 in. legend for metal guard ZBZ160●	Without	Yellow	10	ZBY9140M	0.004/0.009
	ARRET D'URGENCE	Yellow	10	ZBY9130M	0.004/0.009
	EMERGENCY STOP	Yellow	10	ZBY9330M	0.004/0.009
	NOT-HALT	Yellow	10	ZBY9230M	0.004/0.009
	PARADA DE EMERGENZA	Yellow	10	ZBY9430M	0.004/0.009
	NOODSTOP	Yellow	10	ZBY9530M	0.004/0.009
	ARRESTO DI EMERGENZA	Yellow	10	ZBY9630M	0.004/0.009
	NODSTOPP	Yellow	10	ZBY9730M	0.004/0.009
	NODSTOP	Yellow	10	ZBY9830M	0.004/0.009



For Emergency switching off function

Ø 60 mm/2.362 in. legend for metal guard ZBZ160●	Without	Yellow	10	ZBY9101M	0.004/0.009
	COUPURE D'URGENCE	Yellow	10	ZBY9160M	0.004/0.009
	EMERGENCY SWITCHING OFF	Yellow	10	ZBY9360M	0.004/0.009
	NOT-AUS	Yellow	10	ZBY9260M	0.004/0.009
	DESCONEXION DE EMERGENCIA	Yellow	10	ZBY9460M	0.004/0.009
	INTERRUZIONE DI EMERGENZA	Yellow	10	ZBY9660M	0.004/0.009



(1) No isolation function is possible when this guard is fitted.



ZBZ2102

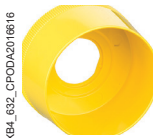

ZB4BZ1905



ZB4BZ2005



ZB4BZ64

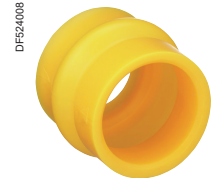

ZBZ58

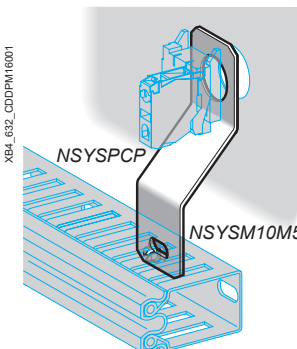

Other accessories

Description	For use with	Color	Reference	Weight kg/lb
Plastic guard	Selector switches and key switches	Black	ZBZ2102	0.005/0.011
	Emergency stop and Emergency switching off function	Yellow Round guard 63.5 mm/ 2.5 in.	ZB4BZ1905	0.005/0.011
		Yellow Round guard 76.2 mm/ 3 in.	ZB4BZ2105	0.005/0.011
Padlockable flaps	Pushbuttons	Yellow Narrow flange guard	ZB4BZ2005	0.005/0.011
		Black	ZB4BZ62	0.076/0.168
		Red	ZB4BZ64	0.076/0.168
		Yellow	ZB4BZ65	0.076/0.168
	Blue	ZB4BZ66	0.076/0.168	

Description	Material	For use with	Color	Sold in lots of	Unit reference	Weight kg/lb
Bellows seals for harsh environments (environments subject to humidity, dust, high-pressure cleaning, etc.) (1)	Silicone	Other functions	Black	2	ZBZ28	0.009/0.020
		Emergency stop/ switching off function	Yellow	2	ZBZ58	0.009/0.020

Description	Application	Sold in lots of	Unit reference	Weight kg/lb
Cable ducting support	Attached beneath head	10	NSYSPCP	0.030/0.066
M5 x 10 screw, with hexagonal slotted head	For attaching cable ducting	100	NSYSM10M5HP	0.003/0.007
Support	For pushbuttons, switches, and pilot lights	1	DX1AP52	0.160/0.353
Boot for contact block ZBE10● and ZBE10●3 (2)	For protection against dusty environment	1	ZBZ60	0.098/0.216

(1) Only when mounted on control stations. Use legends **ZBY9●●●T**.
 (2) Restriction on use: Refer to the product instruction sheet on the Schneider Electric website, Harmony XB4 page.



ZB4SZ3



ZB4FBZ014



ZB4BZ007



ZB4FBZ100



ZBSP2

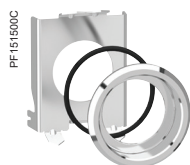

ZB4BZ021

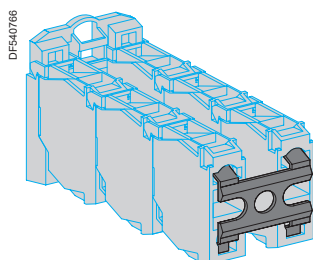

ZBZ007

Other accessories (continued)

Description	For use with	Color	Sold in lots of	Unit reference	Weight kg/lb
Metal circular blanking plug (1)	Ø 22 mm/0.866 in. control and signaling units	Chromium plated	10	ZB4SZ3	0.023/0.051
		Black	10	ZB4SZ37	0.023/0.051
Flush mounted metal circular blanking plug	Ø 30 mm/1.181 in. flush mounted control and signaling units	Chromium plated	10	ZB4FSZ3	0.070/0.154
Plastic blanking plug (with fixing nut)	Ø 22 mm/0.866 in. control and signaling units	Black	10	ZB5SZ3	0.009/0.020
Metal ring for flush mounted Ø 30 mm/1.181 in. NEMA hole	Ø 30 mm/1.181 in. flush mounted control and signaling units	Chromium plated	10	ZB4FBZ014	0.012/0.027
Liquid spray protective washer to be fitted under the head	Ø 22 mm/0.866 in. control and signaling units	Chromium plated	10	ZB4BZ007	0.010/0.022
		Black	10	ZB4BZ0077	0.010/0.022
	Ø 30 mm/1.181 in. flush mounted control and signaling units	Chromium plated	10	ZB4FBZ007	0.003/0.006
Earth plate	Ø 30 mm/1.181 in. flush mounted control and signaling units	Chromium plated	10	ZB4FBZ100	0.007/0.0160
Spacer for metal flush offer	Ø 30 mm/1.181 in. flush mounted control and signaling units		10	ZB4FBZ010	0.003/0.006
Plastic protection cover IP65/IP67	Ø 22 mm/0.866 in. USB and RJ45 ports	Black	10	ZBSP1	0.002/0.004
Rigid plastic protection cover IP65/IP67	Ø 22 mm/0.866 in. USB and RJ45 ports	Transparent	1	ZBSP2	0.006/0.013
Metal protection cover IP65/IP67/IP69K	Ø 22 mm/0.866 in. USB and RJ45 ports	Silver	1	ZBSP3	0.010/0.022
Ø 30 mm/1.181 in. flush mounting kit for pushbuttons and pilot lights	ZB4B● pushbutton with head mounted flush with bezel	Chromium plated	1	ZB4BZ021	0.019/0.042
Ø 30 mm/1.181 in. flush mounting kit for selector switches and illuminated pushbuttons	ZB4B● pushbutton with head mounted flush with bezel	Chromium plated	1	ZB4BZ022	0.021/0.046
Ø 30 mm/1.181 in. flush mounting kit for pushbuttons and pilot lights	ZB4B● pushbutton with head mounted flush with bezel	Metal black	1	ZB4BZ0217	0.019/0.042
Ø 30 mm/1.181 in. flush mounting kit for selector switches and illuminated pushbuttons	ZB4B● pushbutton with head mounted flush with bezel	Metal black	1	ZB4BZ0227	0.021/0.046
Adapter (Ø 30 to Ø 22 mm/1.181 to 0.866 in. reducer)	All pushbuttons	Chromium plated	1	ZB4BZ012	0.023/0.051
Plastic clips	2 or 3 levels of ZBE10● contact blocks in high vibration environment	–	10	ZBZ007	0.001/0.002
Dummy contact block	ZBE10● contact blocks and ZBV5B transformer blocks	–	5	ZBE000	0.006/0.0123
Set of tabs for Faston connection	ZBE10● contact blocks and ZBV● light blocks	–	10	ZBZ003	0.001/0.002

(1) Body/fixing collar ZB4BZ009 required for mounting to be ordered separately (see page 79).

Control and signaling units Ø 22

Harmony XB4, metal

Accessories for illuminated pushbuttons: bulbs

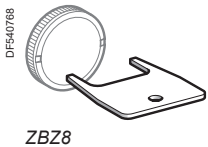
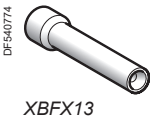

Bulbs with BA 9s base fitting and associated accessories

Description	Characteristics	Color	Sold in lots of	Unit reference	Weight kg/lb
LEDs	24 V ~	White	1	DL1CJ0241	0.002/0.004
		Green	1	DL1CJ0243	0.002/0.004
		Red	1	DL1CJ0244	0.002/0.004
		Orange	1	DL1CJ0245	0.002/0.004
		Blue	1	DL1CJ0246	0.002/0.004
	48 V ~	Green	1	DL1CJ0483	0.002/0.004
		Red	1	DL1CJ0484	0.002/0.004
		Orange	1	DL1CJ0485	0.002/0.004
	6 V - 1.2 W	White	1	DL1CD0061	0.002/0.004
		Green	1	DL1CD0063	0.002/0.004
		Red	1	DL1CD0064	0.002/0.004
		Orange	1	DL1CD0065	0.002/0.004
		Blue	1	DL1CD0066	0.002/0.004
Incandescent bulbs	6 V - 1.2 W	–	10	DL1CB006	0.002/0.004
	24 V - 2 W	–	10	DL1CE024	0.002/0.004
	120...130 V 2.4 W	–	10	DL1CE130	0.002/0.004
Neon bulbs	120...130 V	–	10	DL1CF110	0.002/0.004
	230...240 V	–	10	DL1CF220	0.002/0.004
Bulb extractor	–	–	1	XBFX13	0.005/0.011
Lens cap tightening tool	Illuminated pushbuttons, with flush push	–	1	ZBZ8	0.009/0.020

Other accessories

Description	Characteristics	Sold in lots of	Unit reference	Weight kg/lb
Anti-rotation plate for flush mounted heads	For ZB4F selector switch heads	10	ZB5FAZ902	0.008/0.018



ZBG455



ZBDLU1



ZBG455P



ZBGP



ZBDD2

Replacement keys

Description	Key number	Reference	Weight kg/lb
For latching mushroom head pushbuttons and selector switches			
Sets of 2 keys	455	ZBG455	0.013/0.029
	421E	ZBG421E	0.014/0.031
	458A	ZBG458A	0.014/0.031
	520E	ZBG520E	0.014/0.031
	3131A	ZBG3131A	0.014/0.031
	4A185	ZBDA185	0.014/0.031
	LU1	ZBDLU1	0.014/0.031
	LU2	ZBDLU2	0.014/0.031
	LU3	ZBDLU3	0.014/0.031
	LU4	ZBDLU4	0.014/0.031
	LU5	ZBDLU5	0.014/0.031
	LU6	ZBDLU6	0.014/0.031
	LU7	ZBDLU7	0.014/0.031
	LU8	ZBDLU8	0.014/0.031
	LU9	ZBDLU9	0.014/0.031
	LU10	ZBDLU10	0.014/0.031
	LU11	ZBDLU11	0.014/0.031
	LU12	ZBDLU12	0.014/0.031
	LU13	ZBDLU13	0.014/0.031
	LU14	ZBDLU14	0.014/0.031
	8D1	ZBD8D1	0.014/0.031
Specific key		ZBGK (1)	0.014/0.031

For booted selector switches

Sets of 2 keys, one of which is supplied booted (rubber boot)	455	ZBG455P	–
	421E	ZBG421EP	–
	458A	ZBG458AP	–
	520E	ZBG520EP	–
	3131A	ZBG3131AP	–

Accessory for key switches (2)



Description	Function	Reference	Weight kg/lb
Keyhole cover (rubber boot)	Protection of lock barrel when no key inserted in lock	ZBGP	0.005/0.011

Boot for standard handle

Description	For use with	Sold in lots of	Unit reference	Weight kg/lb
Boot for standard handle	ZB4BD●● and ZB5AD●●	10	ZBDD2	0.005/0.011

(1) Key number to be added when ordering.

(2) Not compatible with products with TEC10 key.

Product type		Pilot lights	Pushbuttons, selector switches, and pilot lights			Biometric switches
						
Description of range		<ul style="list-style-type: none"> LED pilot lights 	<ul style="list-style-type: none"> Pushbuttons Multiple-headed pushbuttons Emergency Stop pushbuttons Selector switches and key switches Illuminated pushbuttons Pilot lights Flush mounted pushbuttons, selector switches, and pilot lights (1) 			<ul style="list-style-type: none"> Fingerprint readers 24V ~ Stand-alone biometric switches Stand-alone USB biometric switches USB biometric switches dedicated to Schneider HMI (2)
Features	Products	Monolithic, compact, low consumption	Complete units or sub-assemblies (body + head)			Monolithic
	Bezel	Double insulated	Double insulated (4)	Metal, chromium plated, or black	Double insulated	Double insulated, dark gray
	Shape of head	Circular	Circular, square, or rectangular	Circular	Circular or square	–
Drilling or cut-out for fixing		Ø 8 mm and Ø 12 mm/0.315 in. and 0.472 in.	Ø 16 mm/0.630 in.	Ø 22 mm/0.866 in. Ø 30 mm/1.181 in. (for flush mounted control and signaling units)		Ø 22 mm/0.866 in.
Degree of protection	Conforming to IEC 60529	IP40 IP65 with seal	IP65	IP66, IP67, IP69, and IP69K		IP65 (control button)
	Conforming to UL 508 and CSA C22-2 No. 14	–	Enclosure type 4, 4X, and 13			Enclosure type 12
Cabling		Tags for 2.8 x 0.5 mm/0.110 x 0.020 in. connectors or threaded connector	Faston connectors Solder pins for printed circuit boards (4) Fast connector socket (5)	Spring clamp terminal connections Screw clamp terminal connections Faston connectors Connector with adapter for printed circuit board		Cable or connectors
Mounting	Panel thickness	1...8 mm/0.039...0.315 in.	1...6 mm/0.039...0.236 in.			
Type references		XVLA	XB6, XB6E	XB4	XB5	XB5S

(1) Flush mounted control and signaling units are available for Harmony XB4 and XB5 ranges only.
 (2) Compatible with Magelis iPC, STU, OT, GXO, GT (except GT1000 series), GK, GH, and GTO models.
 (3) Wireless and batteryless pushbutton and receiver ready-paired at the factory.

Wireless and batteryless pushbuttons	Pushbuttons, selector switches, and pilot lights	Joystick controllers	Pushbuttons, selector switches, and pilot lights	Cam switches	
					
<ul style="list-style-type: none"> Wireless and batteryless pushbuttons and rope pull switch Wireless receivers Harmony Hub 	<ul style="list-style-type: none"> Pushbuttons Emergency Stop and Emergency switching off pushbuttons Selector switches and key switches Illuminated pushbuttons Pilot lights 	<ul style="list-style-type: none"> 2- or 4-direction Stay put or spring return 	<ul style="list-style-type: none"> Pushbuttons Emergency Stop pushbuttons Selector switches and key switches Illuminated pushbuttons Pilot lights 	<ul style="list-style-type: none"> Switches Stepping switches Reversing and changeover switches Ammeter switches Voltmeter switches Reversing switches Star-delta and reversing star-delta switches Pole change switches 	
Ready-to-use packs (3) and "components" range	Monolithic	Complete units or sub-assemblies (body + head with lever)	Complete units or sub-assemblies (body + head)	Complete units or sub-assemblies (body + front panel+ head)	
Metal, chromium plated, or double insulated, black	Double insulated, dark gray (or white for pilot lights)	Metal, chromium plated	Double insulated, black	Metal, chromium plated, or double insulated, black	
Transmitter with circular head	Circular	Circular	Hexagonal	Square	
Ø 22 mm/0.866 in.			Ø 30 mm/1.181 in.	Ø 16 or Ø 22 mm/0.630 or 0.866 in.: series K10 Ø 22 mm/0.866 in. and multifixing: series K1/K2 4 holes, 48 or 68 centers: series K30...K150	
IP65	IP65 (control buttons and pilot lights) IP54 (Emergency switching off pushbuttons)	IP65	IP66	IP65	IP66
Enclosure type 12	Enclosure type 3 (pushbuttons and Emergency stop) and 4 (pilot lights)	Enclosure type 4, 4X and 13	Enclosure type 4 and 13 (9001K) Enclosure type 4, 4X, 13 (9001SK)	–	IP65: series K10 IP40, IP65 with seal: series K1/K2 IP40: series K30...K150
Wireless (transmitter) Through cable (receiver)	Screw and captive clamp terminal connections Faston clip connections (pilot lights)	Screw and captive clamp terminal connections			
1...6 mm/0.039...0.236 in.				0.5...6 mm/0.020...0.236 in. (depending on model)	
XB5R, XB4R	XB7	XD4PA	XD2GA	XD5PA	9001K, 9001SK
					K10, K1, K2, K30, K50, K63, K115, K150

(4) For Harmony XB6 only.
 (5) For Harmony XB6E only.

ZB4BA68	26	ZB4BC28021	48	ZB4BH43	51	ZB4BL435	29	ZB4BV3D4	89
	31	ZB4BC38023	48	ZB4BH053	51	ZB4BL7340	40	ZB4BV3D5	89
ZB4BA79	40	ZB4BC48021	48	ZB4BH53	51	ZB4BL7341	40	ZB4BV3D6	89
ZB4BA88	31	ZB4BD2	54	ZB4BH063	51	ZB4BP1	28	ZB4BV03S	68
ZB4BA98	26	ZB4BD3	54	ZB4BH63	51	ZB4BP1S	28	ZB4BV04	68
	31	ZB4BD4	54	ZB4BH083	51		92	ZB4BV4	89
ZB4BA131	29	ZB4BD5	54	ZB4BH83	51	ZB4BP2	28	ZB4BV4D1	89
ZB4BA133	29	ZB4BD7	54	ZB4BJ2	55	ZB4BP2S	28	ZB4BV4D3	89
ZB4BA136	29	ZB4BD8	54	ZB4BJ3	55		92	ZB4BV4D4	89
ZB4BA141	29	ZB4BD28	57	ZB4BJ4	55	ZB4BP3	28	ZB4BV4D5	89
ZB4BA142	29	ZB4BD29	57	ZB4BJ5	55	ZB4BP3S	28	ZB4BV4D6	89
ZB4BA145	29	ZB4BD39	57	ZB4BJ7	55		92	ZB4BV04S	68
ZB4BA232	29	ZB4BD48	57	ZB4BJ8	55	ZB4BP4	28	ZB4BV05	68
ZB4BA233	29	ZB4BD49	57	ZB4BK1213	59	ZB4BP4S	28	ZB4BV5	89
ZB4BA234	29	ZB4BD59	57	ZB4BK1233	59		92	ZB4BV5D1	89
ZB4BA235	29	ZB4BD79	57	ZB4BK1243	59	ZB4BP5	28	ZB4BV5D3	89
ZB4BA245	29	ZB4BD89	57	ZB4BK1253	59	ZB4BP5S	28	ZB4BV5D4	89
ZB4BA331	29	ZB4BD912	72	ZB4BK1263	59		92	ZB4BV5D5	89
ZB4BA333	29	ZB4BD922	72	ZB4BK1283	59	ZB4BP6	28	ZB4BV5D6	89
ZB4BA334	29	ZB4BG0	56	ZB4BK1313	59	ZB4BP6S	28	ZB4BV05S	68
ZB4BA335	29	ZB4BG0TEC10	57	ZB4BK1333	59		92	ZB4BV06	68
ZB4BA336	29	ZB4BG1	56	ZB4BK1343	58	ZB4BP18	28	ZB4BV6	89
ZB4BA341	29	ZB4BG01	56		59	ZB4BP38	28	ZB4BV06S	68
ZB4BA342	29	ZB4BG02	56	ZB4BK1353	59	ZB4BP48	28	ZB4BV07	68
ZB4BA432	29	ZB4BG2	56	ZB4BK1363	59	ZB4BP58	28	ZB4BV07S	68
ZB4BA433	29	ZB4BG2TEC10	57	ZB4BK1383	59	ZB4BP68	28	ZB4BV7	89
ZB4BA434	29	ZB4BG3	56	ZB4BK1413	59	ZB4BP183	28	ZB4BV8	89
ZB4BA435	29	ZB4BG03	56	ZB4BK1433	59	ZB4BP383	28	ZB4BV9	89
ZB4BA791	41	ZB4BG3	56	ZB4BK1443	59	ZB4BP483	28	ZB4BV013	67
ZB4BA7120	40	ZB4BG3TEC10	57	ZB4BK1453	59	ZB4BP583	28	ZB4BV013E	67
ZB4BA7121	40	ZB4BG4	56	ZB4BK1463	59	ZB4BP683	28	ZB4BV013S	67
ZB4BA7340	40	ZB4BG04	56	ZB4BK1483	59	ZB4BR2	42	ZB4BV18B1	87
ZB4BA7341	40	ZB4BG4TEC10	57	ZB4BK1513	59	ZB4BR3	42	ZB4BV18B3	87
ZB4BA71115	41	ZB4BG5	56	ZB4BK1533	59	ZB4BR4	42	ZB4BV18B4	87
ZB4BA71123	41	ZB4BG05	56	ZB4BK1543	59	ZB4BR5	42	ZB4BV18B5	87
ZB4BA71124	41	ZB4BG5TEC10	57	ZB4BK1553	59	ZB4BR6	42	ZB4BV18B6	87
ZB4BA72124	41	ZB4BG05TEC10	57	ZB4BK1563	59	ZB4BR216	42	ZB4BV18G1	87
ZB4BA73132	41	ZB4BG6	56	ZB4BK1583	59	ZB4BR316	42	ZB4BV18G3	87
ZB4BA73133	41	ZB4BG6TEC10	57	ZB4BK1713	59	ZB4BR416	42	ZB4BV18G4	87
ZB4BA73134	41	ZB4BG7	56	ZB4BK1733	59	ZB4BR516	42	ZB4BV18G5	87
ZB4BA73135	41	ZB4BG7TEC10	57	ZB4BK1743	59	ZB4BR616	42	ZB4BV18G6	87
ZB4BB2	75	ZB4BG8	56	ZB4BK1753	59	ZB4BS12	43	ZB4BV18M1	87
ZB4BB4	75	ZB4BG08	56	ZB4BK1763	59	ZB4BS22	43	ZB4BV18M3	87
ZB4BC2	42	ZB4BG9	56	ZB4BK1783	59	ZB4BS42	43	ZB4BV18M4	87
ZB4BC3	42	ZB4BG09	56	ZB4BK1813	59	ZB4BS52	43	ZB4BV18M5	87
ZB4BC4	42	ZB4BG9TEC10	57	ZB4BK1833	59	ZB4BS55	43	ZB4BV18M6	87
ZB4BC5	42	ZB4BH0	50	ZB4BK1843	59	ZB4BS62	43	ZB4BV033	67
ZB4BC6	42	ZB4BH01	50	ZB4BK1853	59	ZB4BS72	43	ZB4BV033E	67
ZB4BC24	42	ZB4BH1	50	ZB4BK1863	59	ZB4BS834	45	ZB4BV033S	67
ZB4BC34	42	ZB4BH02	50	ZB4BK1883	59	ZB4BS844	45	ZB4BV043	67
ZB4BC44	42	ZB4BH2	50	ZB4BL1	27	ZB4BS864	45	ZB4BV043E	67
ZB4BC54	42	ZB4BH03	50	ZB4BL2	27	ZB4BS934	45	ZB4BV043S	67
ZB4BC64	42	ZB4BH3	50	ZB4BL3	27	ZB4BS944	45	ZB4BV053	67
ZB4BC180	48	ZB4BH04	50	ZB4BL4	27	ZB4BS964	45	ZB4BV053E	67
ZB4BC280	48	ZB4BH4	50	ZB4BL5	27	ZB4BT2	43	ZB4BV053S	67
ZB4BC380	48	ZB4BH5	50	ZB4BL6	27	ZB4BT84	45	ZB4BV063	67
ZB4BC480	48	ZB4BH05	50	ZB4BL232	29	ZB4BT844	45	ZB4BV063E	67
ZB4BC580	48	ZB4BH6	50	ZB4BL233	29	ZB4BV01	68	ZB4BV063S	67
ZB4BC680	48	ZB4BH06	50	ZB4BL234	29	ZB4BV01S	68	ZB4BV083	67
ZB4BC780	48	ZB4BH6	50	ZB4BL235	29	ZB4BV003	67	ZB4BV083E	67
ZB4BC980	48	ZB4BH013	51	ZB4BL432	29	ZB4BV03	68	ZB4BV083S	67
ZB4BC18023	48	ZB4BH13	51	ZB4BL433	29	ZB4BV3	89	ZB4BV156	89
ZB4BC28001	48	ZB4BH033	51	ZB4BL434	29	ZB4BV3D1	89	ZB4VB1	86
		ZB4BH33	51			ZB4BV3D3	89	ZB4VB3	86
		ZB4BH043	51						

ZB4BVB4	86	ZB4BW0G43	84	ZB4BW16S	33	ZB4BW653	43	ZB4FA18	34
ZB4BVB5	86	ZB4BW0G45	84	ZB4BW17	33	ZB4BW663	43		38
ZB4BVB6	86	ZB4BW0G51	84	ZB4BW17S	33	ZB4BW913	31	ZB4FA26	34
ZB4BVB1156	87	ZB4BW0G52	84	ZB4BW31	33	ZB4BW933	31	ZB4FA36	34
ZB4BVB3156	87	ZB4BW0G53	84	ZB4BW031	88	ZB4BW943	31	ZB4FA38	34
ZB4BVB4156	87	ZB4BW0G55	84	ZB4BW31S	33	ZB4BW953	31		38
ZB4BVB5156	87	ZB4BW0G61	84	ZB4BW33	33	ZB4BW963	31	ZB4FA46	34
ZB4BVB6156	87	ZB4BW0G62	84	ZB4BW33S	33	ZB4BW983	31	ZB4FA48	34
ZB4BVBG1	86	ZB4BW0G63	84	ZB4BW34	33	ZB4BX2	43		38
ZB4BVBG3	86	ZB4BW0G65	84	ZB4BW34S	33	ZB4BX84	45	ZB4FA56	34
ZB4BVBG4	86	ZB4BW0M11	85	ZB4BW35	33	ZB4BZ007	109	ZB4FA58	34
ZB4BVBG5	86	ZB4BW0M12	85	ZB4BW35S	88	ZB4BZ009	76		38
ZB4BVBG6	86	ZB4BW0M13	85	ZB4BW35S	33		79	ZB4FA66	34
ZB4BVG1	86	ZB4BW0M15	85	ZB4BW36	33		81	ZB4FA68	34
ZB4BVG3	86	ZB4BW0M31	85	ZB4BW36S	33		83		38
ZB4BVG4	86	ZB4BW0M32	85	ZB4BW37	33	ZB4BZ012	109	ZB4FA88	38
ZB4BVG5	86	ZB4BW0M33	85	ZB4BW37S	33	ZB4BZ021	109	ZB4FA131	36
ZB4BVG6	86	ZB4BW0M35	85	ZB4BW41	88	ZB4BZ022	109	ZB4FA133	36
ZB4BVG35	80	ZB4BW0M41	85	ZB4BW041	88	ZB4BZ62	108	ZB4FA136	36
ZB4BVG45	80	ZB4BW0M42	85	ZB4BW045	88	ZB4BZ64	108	ZB4FA141	36
ZB4BVJ1	86	ZB4BW0M43	85	ZB4BW051	88	ZB4BZ64	108	ZB4FA142	36
ZB4BVJ3	86	ZB4BW0M45	85	ZB4BW055	88	ZB4BZ65	108	ZB4FA145	36
ZB4BVJ4	86	ZB4BW0M51	85	ZB4BW061	88	ZB4BZ66	108	ZB4FA232	36
ZB4BVJ5	86	ZB4BW0M52	85	ZB4BW062	88	ZB4BZ0077	109	ZB4FA233	36
ZB4BVJ6	86	ZB4BW0M53	85	ZB4BW063	88	ZB4BZ079	81	ZB4FA234	36
ZB4BVM1	86	ZB4BW0M55	85	ZB4BW065	88	ZB4BZ101	76	ZB4FA235	36
ZB4BVM3	86	ZB4BW0M61	85	ZB4BW113	32	ZB4BZ102	76	ZB4FA245	36
ZB4BVM4	86	ZB4BW0M62	85	ZB4BW113S	32	ZB4BZ103	76	ZB4FA331	36
ZB4BVM5	86	ZB4BW0M63	85	ZB4BW133	32	ZB4BZ104	76	ZB4FA333	36
ZB4BVM6	86	ZB4BW0M65	85	ZB4BW133S	32	ZB4BZ105	76	ZB4FA333	36
ZB4BW0B11	84	ZB4BW03D15	88	ZB4BW143	32	ZB4BZ106	76	ZB4FA334	36
ZB4BW0B12	84	ZB4BW03D35	88	ZB4BW143S	32	ZB4BZ107	76	ZB4FA335	36
ZB4BW0B13	84	ZB4BW03D45	88	ZB4BW153	32	ZB4BZ107	76	ZB4FA336	36
ZB4BW0B15	84	ZB4BW03D55	88	ZB4BW153S	32	ZB4BZ141	76	ZB4FA341	36
ZB4BW0B31	84	ZB4BW03D65	88	ZB4BW163	32	ZB4BZ0217	109	ZB4FA342	36
ZB4BW0B32	84	ZB4BW04D15	88	ZB4BW163S	32	ZB4BZ0227	109	ZB4FA432	36
ZB4BW0B33	84	ZB4BW04D35	88	ZB4BW163S	32	ZB4BZ1013	82	ZB4FA433	36
ZB4BW0B35	84	ZB4BW04D45	88	ZB4BW183	32	ZB4BZ1014	83	ZB4FA433	36
ZB4BW0B41	84	ZB4BW04D55	88	ZB4BW183S	32	ZB4BZ1015	79	ZB4FA434	36
ZB4BW0B42	84	ZB4BW04D65	88	ZB4BW313	31	ZB4BZ1023	82	ZB4FA435	36
ZB4BW0B43	84	ZB4BW05D15	88	ZB4BW313S	31	ZB4BZ1024	83	ZB4FBZ007	109
ZB4BW0B45	58	ZB4BW05D35	88	ZB4BW333	31	ZB4BZ1025	79	ZB4FBZ010	109
	64	ZB4BW05D45	88	ZB4BW333S	31	ZB4BZ1033	82	ZB4FBZ014	109
	84	ZB4BW05D55	88	ZB4BW343	31	ZB4BZ1034	83	ZB4FBZ100	109
ZB4FK1343	64	ZB4BW05D65	88	ZB4BW343S	31	ZB4BZ1035	79	ZB4FD2	60
	65	ZB4BW7A9	40	ZB4BW353	31	ZB4BZ1043	82	ZB4FD2M178	60
ZB4BW0B51	84	ZB4BW7A1715	40	ZB4BW353S	31	ZB4BZ1044	83	ZB4FD3	60
ZB4BW0B52	84	ZB4BW7A1720	40	ZB4BW363	31	ZB4BZ1045	79	ZB4FD4	60
ZB4BW0B53	84	ZB4BW7A1724	40	ZB4BW363S	31	ZB4BZ1053	82	ZB4FD5	60
ZB4BW0B55	84	ZB4BW7A1724	40	ZB4BW383	31	ZB4BZ1054	83	ZB4FD7	60
ZB4BW0B61	84	ZB4BW7A1724	40	ZB4BW383S	31	ZB4BZ1055	79	ZB4FD8	60
ZB4BW0B62	84	ZB4BW7A3740	40	ZB4BW413	42	ZB4BZ1414	83	ZB4FD29	63
ZB4BW0B63	84	ZB4BW7A3741	40	ZB4BW433	42	ZB4BZ1905	108	ZB4FD39	63
ZB4BW0B65	84	ZB4BW7L3740	40	ZB4BW443	42	ZB4BZ2005	108	ZB4FD59	63
ZB4BW0G11	84	ZB4BW7L3741	40	ZB4BW453	42	ZB4BZ2105	108	ZB4FD79	63
ZB4BW0G12	84	ZB4BW11	33	ZB4BW463	42	ZB4FA0	34	ZB4FD89	63
ZB4BW0G13	84	ZB4BW11S	33	ZB4BW513	31	ZB4FA1	34	ZB4FG0	62
ZB4BW0G15	84	ZB4BW13	33	ZB4BW533	31	ZB4FA2	34	ZB4FG1	62
ZB4BW0G31	84	ZB4BW13S	33	ZB4BW543	31	ZB4FA3	34	ZB4FG01	62
ZB4BW0G32	84	ZB4BW14	33	ZB4BW553	31	ZB4FA3M33	34	ZB4FG2	62
ZB4BW0G33	84	ZB4BW14S	33	ZB4BW563	31	ZB4FA4	34	ZB4FG02	62
ZB4BW0G35	84	ZB4BW15	33	ZB4BW583	31	ZB4FA5	34	ZB4FG03	62
ZB4BW0G41	84	ZB4BW15S	33	ZB4BW613	43	ZB4FA6	34	ZB4FG3	62
ZB4BW0G42	84	ZB4BW16	33	ZB4BW633	43	ZB4FA8	34	ZB4FG04	62
				ZB4BW643	47	ZB4FA9	34	ZB4FG4	62
						ZB4FA16	34	ZB4FG5	62

ZB4FG05	62	ZB4FK1743	65	ZBA136	90	ZBDD2	111	ZBG520EP	111
ZB4FG6	62	ZB4FK1753	65	ZBA137	90	ZBDLU1	111	ZBG2201	74
ZB4FG7	62	ZB4FK1763	65	ZBA141	90	ZBDLU2	111	ZBG2401	74
ZB4FG8	62	ZB4FK1783	65	ZBA142	90	ZBDLU3	111	ZBG3131A	111
ZB4FG08	62	ZB4FK1813	65	ZBA145	90	ZBDLU4	111	ZBG3131AP	111
ZB4FG09	62	ZB4FK1833	65	ZBA232	90	ZBDLU5	111	ZBG4201	74
ZB4FG9	62	ZB4FK1843	65	ZBA233	90	ZBDLU6	111	ZBG4401	74
ZB4FH0	52	ZB4FK1853	65	ZBA234	90	ZBDLU7	111	ZBGK	111
ZB4FH01	52	ZB4FK1863	65	ZBA235	90	ZBDLU8	111	ZBGP	111
ZB4FH1	52	ZB4FK1883	65	ZBA245	90	ZBDLU9	111	ZBL1	90
ZB4FH02	52	ZB4FL1	35	ZBA331	90	ZBDLU10	111	ZBL2	90
ZB4FH2	52	ZB4FL2	35	ZBA333	90	ZBDLU11	111	ZBL3	90
ZB4FH03	52	ZB4FL3	35	ZBA334	90	ZBDLU12	111	ZBL4	90
ZB4FH3	52	ZB4FL4	35	ZBA335	90	ZBDLU13	111	ZBL5	90
ZB4FH04	52	ZB4FL4M34	35	ZBA336	90	ZBDLU14	111	ZBL6	90
ZB4FH4	52	ZB4FL5	35	ZBA337	90	ZBE000	109	ZBL9	90
ZB4FH05	52	ZB4FL6	35	ZBA338	90	ZBE101	76	ZBL138	90
ZB4FH5	52	ZB4FL232	36	ZBA341	90	ZBE102	76	ZBP0	92
ZB4FH06	52	ZB4FL233	36	ZBA342	90	ZBE201	76	ZBP0A	92
ZB4FH6	52	ZB4FL234	36	ZBA343	90	ZBE202	76	ZBP011	92
ZB4FH013	53	ZB4FL235	36	ZBA344	90	ZBE203	76	ZBP012	92
ZB4FH13	53	ZB4FL432	36	ZBA346	90	ZBE204	76	ZBP013	92
ZB4FH033	53	ZB4FL433	36	ZBA432	90	ZBE205	76	ZBP014	92
ZB4FH33	53	ZB4FL434	36	ZBA433	90	ZBE501	76	ZBP015	92
ZB4FH043	53	ZB4FL435	36	ZBA434	90	ZBE502	76	ZBP016	92
ZB4FH43	53	ZB4FSZ3	109	ZBA435	90	ZBE503	76	ZBP017	92
ZB4FH053	53	ZB4FV013	71	ZBA639	90	ZBE504	76	ZBPA	92
ZB4FH53	53	ZB4FV033	71	ZBA2934	90	ZBE505	76	ZBSP1	109
ZB4FH063	53	ZB4FV043	71	ZBA2935	90	ZBE701	81	ZBSP2	109
ZB4FH63	53	ZB4FV053	71	ZBAF131	91	ZBE702	81	ZBSP3	109
ZB4FH083	53	ZB4FV063	71	ZBAF133	91	ZBE1013	82	ZBV5B	78
ZB4FH83	53	ZB4FV083	71	ZBAF136	91	ZBE1014	83	ZBV6	89
ZB4FJ2	61	ZB4FW113	39	ZBAF137	91	ZBE1015	79	ZBV011	93
ZB4FJ3	61	ZB4FW133	39	ZBAF138	91	ZBE1016	76	ZBV013	93
ZB4FJ4	61	ZB4FW143	39	ZBAF141	91	ZBE1016P	76	ZBV014	93
ZB4FJ5	61	ZB4FW153	39	ZBAF142	91	ZBE1016P3	82	ZBV015	93
ZB4FJ7	61	ZB4FW163	39	ZBAF145	91	ZBE1023	82	ZBV016	93
ZB4FJ8	61	ZB4FW183	39	ZBAF232	91	ZBE1024	83	ZBV017	93
ZB4FK1213	65	ZB4FW313	38	ZBAF233	91	ZBE1025	79	ZBV18B1	78
ZB4FK1233	65	ZB4FW333	38	ZBAF234	91	ZBE1026	76	ZBV18B3	78
ZB4FK1243	65	ZB4FW343	38	ZBAF235	91	ZBE1026P	76	ZBV18B4	78
ZB4FK1253	65	ZB4FW353	38	ZBAF245	91	ZBE1026P3	82	ZBV18B5	78
ZB4FK1263	65	ZB4FW363	38	ZBAF331	91	ZBE2013	82	ZBV18B6	78
ZB4FK1283	65	ZB4FW383	38	ZBAF333	91	ZBE2023	82	ZBV18G1	78
ZB4FK1313	65	ZB4FW913	38	ZBAF334	91	ZBE2033	82	ZBV18G3	78
ZB4FK1333	65	ZB4FW933	38	ZBAF335	91	ZBE2043	82	ZBV18G4	78
ZB4FK1353	65	ZB4FW943	38	ZBAF336	91	ZBE2053	82	ZBV18G5	78
ZB4FK1363	65	ZB4FW953	38	ZBAF337	91	ZBE5013	82	ZBV18G6	78
ZB4FK1383	65	ZB4FW963	38	ZBAF338	91	ZBE5023	82	ZBV18M1	78
ZB4FK1413	65	ZB4FW983	38	ZBAF341	91	ZBE5033	82	ZBV18M3	78
ZB4FK1433	65	ZB4SZ3	109	ZBAF342	91	ZBE5043	82	ZBV18M4	78
ZB4FK1443	65	ZB4SZ37	109	ZBAF343	91	ZBE5053	82	ZBV18M5	78
ZB4FK1453	65	ZB5FAZ902	110	ZBAF344	91	ZBE7016	81	ZBV18M6	78
ZB4FK1463	65	ZB5SZ3	109	ZBAF346	91	ZBE7026	81	ZBV0103S	93
ZB4FK1483	65	ZBA1	90	ZBAF432	91	ZBE10163	82	ZBV0113	93
ZB4FK1513	65	ZBA2	90	ZBAF433	91	ZBE10263	82	ZBV0133	93
ZB4FK1533	65	ZBA3	90	ZBAF434	91	ZBG421E	111	ZBV0143	93
ZB4FK1543	65	ZBA4	90	ZBAF435	91	ZBG421EP	111	ZBV0153	93
ZB4FK1553	65	ZBA5	90	ZBAF639	91	ZBG455	111	ZBV0163	93
ZB4FK1563	65	ZBA6	90	ZBAF2934	91	ZBG455P	111	ZBVB1	77
ZB4FK1583	65	ZBA9	90	ZBAF2935	91	ZBG458A	111	ZBVB3	77
ZB4FK1713	65	ZBA131	90	ZBDD1	111	ZBG458AP	111	ZBVB4	77
ZB4FK1733	65	ZBA133	90	ZBDA185	111	ZBG520E	111	ZBVB5	77

ZBVB6	77	ZBVM35	80	ZBY9W2M230	46	ZBY02107	97	ZBY2185	94
ZBVB8	77	ZBVM44	83		105	ZBY2108	94	ZBY02185	97
ZBVB14	83	ZBVM45	80	ZBY9W2M330	46	ZBY02108	97	ZBY2186	94
ZBVB15	80	ZBVM54	83		105	ZBY2109	94	ZBY02186	97
ZBVB17	81	ZBVM55	80	ZBY9W2M430	46	ZBY02109	97	ZBY2186C0	94
ZBVB34	83	ZBVM64	83		105	ZBY2110	94	ZBY2195	94
ZBVB35	80	ZBVM65	80	ZBY9W2M630	46	ZBY02110	97	ZBY02195	97
ZBVB37	81	ZBW911	93		105	ZBY2111	94	ZBY2196	94
ZBVB44	83	ZBW913	93	ZBY9W3B101	103	ZBY02111	97	ZBY02196	97
ZBVB45	80	ZBW914	93		105	ZBY2112	94	ZBY2197	94
ZBVB47	81	ZBW915	93	ZBY9W3B140	46	ZBY02112	97	ZBY02197	97
ZBVB54	83	ZBW916	93		105	ZBY2113	94	ZBY2198	94
ZBVB55	80	ZBW917	93	ZBY9W3B230	46	ZBY02113	97	ZBY02198	97
ZBVB57	81	ZBW931	93		105	ZBY2114	94	ZBY2199	94
ZBVB64	83	ZBW933	93	ZBY9W3B330	46	ZBY02114	97	ZBY02199	97
ZBVB65	80	ZBW934	93		105	ZBY2115	94	ZBY2203	95
ZBVB67	81	ZBW935	93	ZBY9W3B430	46	ZBY02115	97	ZBY02203	99
ZBVBG1	77	ZBW936	93		105	ZBY2116	94	ZBY2204	95
ZBVBG3	77	ZBW937	93	ZBY9W3B630	46	ZBY02116	97	ZBY02204	99
ZBVBG4	77	ZBW9113	93		105	ZBY2123	94	ZBY2205	95
ZBVBG5	77	ZBW9133	93	ZBY0101	97	ZBY2123	94	ZBY2205	99
ZBVBG6	77	ZBW9143	93	ZBY0102	97	ZBY02123	97	ZBY02205	99
ZBVG1	77	ZBW9153	93	ZBY0104	94	ZBY2126	94	ZBY2206	95
ZBVG3	77	ZBW9163	93	ZBY00104	97	ZBY02126	97	ZBY02206	99
ZBVG4	77	ZBW9313	93	ZBY0123	94	ZBY2127	94	ZBY2207	95
ZBVG5	77	ZBW9333	93	ZBY00123	97	ZBY02127	97	ZBY02207	99
ZBVG6	77	ZBW9343	93	ZBY0140	97	ZBY2128	94	ZBY2208	95
ZBVG8	77	ZBW9353	93	ZBY1101	102	ZBY02128	97	ZBY02208	99
ZBVG14	83	ZBW9363	93	ZBY1103	102	ZBY2129	94	ZBY2209	95
ZBVG15	80	ZBY001	76	ZBY1104	102	ZBY02129	97	ZBY02209	99
ZBVG34	83		80	ZBY1105	102	ZBY02130	97	ZBY2210	95
ZBVG35	80		82	ZBY1106	102	ZBY2130	94	ZBY02210	99
ZBVG44	83	ZBY2H101	94	ZBY1107	102	ZBY2131	94	ZBY2211	95
ZBVG45	80	ZBY4H101	94	ZBY1108	102	ZBY02131	97	ZBY02211	99
ZBVG54	83	ZBY6H101	100	ZBY1115	102	ZBY2132	94	ZBY2212	95
ZBVG55	80	ZBY6H102	100	ZBY1116	102	ZBY02132	97	ZBY02212	99
ZBVG64	83	ZBY9W2B101	103	ZBY1146	102	ZBY2133	94	ZBY2213	95
ZBVG65	80	ZBY9W2B130	46	ZBY1147	102	ZBY02133	97	ZBY02213	99
			105	ZBY1148	102	ZBY2134	94	ZBY2214	95
ZBVG66	80	ZBY9W2B140	46	ZBY1149	102	ZBY02134	97	ZBY02214	99
ZBVG67	81		105	ZBY1203	102	ZBY2135	94	ZBY2223	95
ZBVG8	77	ZBY9W2B230	46	ZBY1207	102	ZBY02135	97	ZBY02223	99
ZBVG14	83		105	ZBY1208	102	ZBY2146	94	ZBY2226	95
ZBVG15	80	ZBY9W2B330	46	ZBY1214	102	ZBY02146	97	ZBY02226	99
ZBVG34	83		105	ZBY1214	102	ZBY2147	94	ZBY2227	95
ZBVG35	80	ZBY9W2B430	46	ZBY1303	102	ZBY02147	97	ZBY02227	99
ZBVG44	83		105	ZBY1304	102	ZBY2148	94	ZBY2228	95
ZBVG45	80	ZBY9W2B630	46	ZBY1311	102	ZBY02148	97	ZBY02228	99
ZBVG54	83		105	ZBY1312	102	ZBY2164	94	ZBY2229	95
ZBVG55	80	ZBY9W2G101	103	ZBY1316	102	ZBY02164	97	ZBY02229	99
ZBVG64	83	ZBY9W2G130	46	ZBY1912	102	ZBY2165	94	ZBY2230	95
ZBVG65	80		105	ZBY2101	94	ZBY02165	97	ZBY02230	99
ZBVG66	80	ZBY9W2G140	46	ZBY2101C0	94	ZBY2166	94	ZBY2231	95
ZBVG67	81		105	ZBY2103	94	ZBY02166	97	ZBY02231	99
ZBVG8	77	ZBY9W2G230	46	ZBY2103	94	ZBY2166C0	94	ZBY2232	95
ZBVG14	83		105	ZBY02103	97	ZBY2167	94	ZBY02232	99
ZBVG15	80	ZBY9W2G330	46	ZBY2104	94	ZBY02167	97	ZBY2233	95
ZBVG34	83		105	ZBY02104	97	ZBY2178	94	ZBY02233	99
ZBVG35	80	ZBY9W2G430	46	ZBY2104C0	94	ZBY02178	97	ZBY2234	95
ZBVG44	83		105	ZBY2105	94	ZBY2178C0	94	ZBY02234	99
ZBVG45	80	ZBY9W2G630	46	ZBY02105	97	ZBY2179	94	ZBY2235	95
ZBVG54	83		105	ZBY2106	94	ZBY02179	97	ZBY02235	99
ZBVG55	80	ZBY9W2M101	103	ZBY02106	97	ZBY2184	94	ZBY2265	95
ZBVG64	83	ZBY9W2M130	46	ZBY2107	94	ZBY02184	97	ZBY02265	99
ZBVG65	80		105						
ZBVG66	80	ZBY9W2M140	46						
ZBVG67	81		105						

ZBY2266	95	ZBY2367	95	ZBY9320	46	ZBYFP2304C0	101	ZBZ007	109
ZBY02266	99	ZBY02367	98		103	ZBYFP2367	101	ZBZ8	110
ZBY2267	95	ZBY2367C0	95	ZBY9330M	107	ZBYFP2367C0	101	ZBZ010	81
ZBY02267	99	ZBY2385	95	ZBY9330T	106	ZBYFP6101	101	ZBZ011	81
ZBY2284	95	ZBY02385	98	ZBY9360	47	ZBYFP6101C0	101	ZBZ012	81
ZBY02284	99		99		103	ZBYLEG101000	104	ZBZ28	47
ZBY2295	95	ZBY2387	95	ZBY9360M	107	ZBYLEG101001	104		108
ZBY02295	99	ZBY02387	98	ZBY9360T	106	ZBYLEG201000	104	ZBZ32	94
ZBY2297	95	ZBY2931	94	ZBY9420	46	ZBYLEG201001	104	ZBZ32C0	94
ZBY02297	99	ZBY02931	97		103	ZBYLEG301000	104	ZBZ33	100
ZBY2298	95	ZBY4100	99	ZBY9430M	107	ZBYLEG301001	104	ZBZ33C0	100
ZBY02298	99	ZBY4101	94	ZBY9460	47	ZBYLEG302000	104	ZBZ34	94
ZBY2299	95	ZBY4101C0	94		103	ZBYLEG302001	104	ZBZ35	100
ZBY02299	99	ZBY4140	94	ZBY9460M	107	ZBYLEG303000	104	ZBZ48	43
ZBY2303	95	ZBY5100	100	ZBY9530M	107	ZBYLEG303001	104		102
ZBY02303	98	ZBY5101	100	ZBY9620	46	ZBYLEG304000	104	ZBZ58	47
ZBY2303C0	95	ZBY5102	100		103	ZBYLEG304001	104		108
ZBY2304	94	ZBY5140	100	ZBY9630M	107	ZBYLEG304001	104	ZBZ60	49
ZBY02304	97	ZBY6101	100	ZBY9660	47	ZBYLEG401000	104		108
ZBY2304C0	94	ZBY6101C0	100		103	ZBYLEG401001	104	ZBZ110	81
ZBY2305	95	ZBY6102	100	ZBY9660M	107	ZBYLEG402000	104	ZBZ1600	107
ZBY02305	98	ZBY6102C0	100	ZBY9730M	107	ZBYLEG402001	104	ZBZ1602	107
ZBY2306	95	ZBY6140	100	ZBY9830M	107	ZBYLEG501000	104	ZBZ1604	107
ZBY02306	98	ZBY8101	47	ZBY55130	100	ZBYLEG501001	104	ZBZ1605	107
ZBY2307	95		103	ZBY55330	100	ZBYLEG502000	104	ZBZ1606	107
ZBY02307	98	ZBY8130	103	ZBY22420001	95	ZBYLEG502001	104	ZBZ1902	49
ZBY2308	95	ZBY8140	103	ZBY022420001	99	ZBYLEG503000	104	ZBZ2102	108
ZBY02308	98	ZBY8160	47	ZBYF2101	101	ZBYLEG503001	104	ZBZ3605	106
ZBY2309	95		103	ZBYF2101C0	101	ZBYLEG504000	104	ZBZF32	101
ZBY02309	98	ZBY8230	103	ZBYF2103	101	ZBYLEG504001	104	ZBZF33	101
ZBY2310	95	ZBY8260	47	ZBYF2103C0	101	ZBYM2101	96	ZBZG156	78
ZBY02310	98		103	ZBYF2166	101	ZBYM2103	96	ZBZM156	78
ZBY2311	95	ZBY8330	103	ZBYF2166C0	101	ZBYM2104	96	ZD4PA12	74
ZBY02311	98	ZBY8360	47	ZBYF2178	101	ZBYM2166	96	ZD4PA14	74
ZBY2312	95		103	ZBYF2178C0	101	ZBYM2178	96	ZD4PA22	74
ZBY02312	98	ZBY8430	103	ZBYF2186	101	ZBYM2186	96	ZD4PA24	74
ZBY2313	95	ZBY8460	47	ZBYF2186C0	101	ZBYM2303	96	ZD4PA103	74
ZBY02313	98		103	ZBYF2303	101	ZBYM2304	96	ZD4PA203	74
ZBY2314	95	ZBY8630	103	ZBYF2303C0	101	ZBYM2367	96		
ZBY02314	98	ZBY8660	47	ZBYF2304	101	ZBYM6101	100		
ZBY2316	95		103	ZBYF2304C0	101	ZBYP2101	96		
ZBY02316	98	ZBY9101	47	ZBYF2367	101	ZBYP2101C0	96		
			103	ZBYF2367C0	101	ZBYP2103	96		
ZBY2321	95	ZBY9101M	107	ZBYF4101	101	ZBYP2103C0	96		
ZBY02321	98	ZBY9101T	106	ZBYF4101C0	101	ZBYP2104	96		
ZBY2322	95	ZBY9120	46	ZBYF6101	101	ZBYP2104C0	96		
ZBY02322	98		103	ZBYF6101C0	101	ZBYP2166	96		
ZBY2323	95	ZBY9121	46	ZBYF6102	101	ZBYP2166C0	96		
ZBY02323	98		103	ZBYF6102C0	101	ZBYP2178	96		
ZBY2326	95	ZBY9130M	107	ZBYFP2101	101	ZBYP2178C0	96		
ZBY02326	98	ZBY9130T	106	ZBYFP2101C0	101	ZBYP2186	96		
ZBY2327	95	ZBY9140M	107	ZBYFP2103	101	ZBYP2186C0	96		
ZBY02327	98	ZBY9140T	106	ZBYFP2103C0	101	ZBYP2303	96		
ZBY2328	95	ZBY9160	47	ZBYFP2104	101	ZBYP2303C0	96		
ZBY02328	98		103	ZBYFP2104C0	101	ZBYP2304	96		
ZBY2330	95	ZBY9160M	107	ZBYFP2166	101	ZBYP2304C0	96		
ZBY02330	98	ZBY9160T	106	ZBYFP2166C0	101	ZBYP2367	96		
ZBY2334	95	ZBY9220	46	ZBYFP2178	101	ZBYP2367C0	96		
ZBY02334	98		103	ZBYFP2178C0	101	ZBYP6101	100		
ZBY2364	95	ZBY9230M	107	ZBYFP2186	101	ZBYP6101C0	100		
ZBY02364	98	ZBY9230T	106	ZBYFP2186C0	101	ZBZ001	76		
		ZBY9260	47	ZBYFP2186C0	101		82		
ZBY2366	95		103	ZBYFP2303	101	ZBZ003	109		
ZBY02366	98	ZBY9260M	107	ZBYFP2303C0	101	ZBZ006	81		
		ZBY9260T	106	ZBYFP2304	101				

Life Is On



Learn more about our products at
www.schneider-electric.com

The information provided in this documentation contains general descriptions and/or technical characteristics of the performance of the products contained herein. This documentation is not intended as a substitute for and is not to be used for determining suitability or reliability of these products for specific user applications. It is the duty of any such user or integrator to perform the appropriate and complete risk analysis, evaluation and testing of the products with respect to the relevant specific application or use thereof. Neither Schneider Electric nor any of its affiliates or subsidiaries shall be responsible or liable for misuse of the information contained herein.

Design: Schneider Electric
Photos: Schneider Electric

Schneider Electric Industries SAS

Head Office
35, rue Joseph Monier - CS 30323
F-92500 Rueil-Malmaison Cedex
France

DIA5ED21212EN
September 2020 - V12.0