

GF Series

Digital counter / Timer

- Counter & timer
- Pre-scale setting (GF7)
- Input action 14 kinds, output action 16 kinds
- Set up the digit of decimal points
- Timer range 16 kinds
(10/60 decimal system each 8 kinds)
- NPN/PNP (voltage / non-voltage) input selectable



C

Counter /
Timer

Suffix code

Model	Code	Description
GF7 -	<input type="checkbox"/> <input type="checkbox"/> <input type="checkbox"/> <input type="checkbox"/>	Digital counter / Timer (72 X 72 mm)
Type	P	Pre-set counter
	T	Total counter
Displayable digits	4	4 digits (9999)
	6	6 digits (999999)
Setting stage	1	1 st stage setting
	2	2 nd stage setting
	0	Total counter
Pre-scale function	E	Pre-scale function built in (Pre-set counter)
	N	No pre-scale (Total counter)

Model	Code	Description
GF4 -	<input type="checkbox"/> <input type="checkbox"/> <input type="checkbox"/> <input type="checkbox"/>	Digital counter / Timer (48 X 48 mm)
Type	P	Pre-set counter
	T	Total counter
Displayable digits	4	4 digits (9999)
Setting stage	1	1 st stage setting (Pre-set counter)
	0	None (total counter)
Terminal structure	N	Terminal
	S	8 pin structure (suitable for 8 pin socket)

Specification

Input

Model	GF4	GF7
Input computation speed	30 cps, 5K cps (select by using the deep switch)	30 cps, 1K, 3K, 5K cps , select by using the volume (located on the front panel)
	ON/OFF ratio: when ratio is 1:1	
Input signal type	PNP input (voltage input) or NPN input (non-voltage input) Signal stage : "H" 5 - 30 V DC "L" 0 - 2 V DC	
Inhibit input	Computation stops when signal is ON (20 ms min)	
Reset	Power reset (for more than 0.5 s), external reset (for more than 20 ms), auto reset	
Noise immunity	Square wave noise due to the noise simulator (1μs pulse width), ±2 kV (between the operation power terminal)	

Function

Timer	setting error	Less than ± 0.01 % ± 0.05 sec (only with the power START)
	Repeating operation error	Less than ± 0.005 % ± 0.003 sec (only with the reset START)
Insulation resistance	100 MΩ min (500 V DC mega electric conduction terminal-non recharging metal)	
Dielectric strength	2000 V AC 60 Hz for 1 min (different charging terminal from each other)	

Function and output

Model	GF4-P41N	GF4-T40N	GF7-P□□E	GF7-T60N
Counter/timer selection	Counter operation and timer operation selectable			
Input action	Up, down, and up/down selectable (refer to the input operation mode)			
Output action (counter)	F, N, C, R, K, P, Q, S, A selectable (refer to the output action mode) ※ With the total counter, it is displayed as F, K output mode			
Output type	ON delay and OFF delay selectable by the deep switch			
OUT1 function selectable	Hold, One-shot, Flickering (1 sec gap) function selectable (applicable only with 2 stages setting type)			
Pre-scale	Applicable only with free-set counter , 0.001 ~ 9999(4digits), 0.00001 ~ 999999(6digits)			
Recognizing computed value setting	Recognize at all times (possible to change the setting in the middle of applying electric current)			
Power backup selectable	Power failure compensation/Power reset selectable, semi-permanent when Selecting power failure compensation (use EEPROM)			
Displayable digits	4 digits (9999)		4 digits / 6 digits	6 digits (999999)
decimal points display	4 digits : 888.8 / 8888, 6 digits : 888888 / 88888.8 / 8888.88 / 888.888			
Setting stage	1 st stage	None	1 st stage / 2 nd stage	None
ONE SHOT output	0.1 ~ 12.5 sec (set by the front TM volume)		0.05 sec - 5.8 sec (set by the front TM volume)	
External power supply	12 V DC 100 mA max.		12 V DC 100 mA max.	
Character display	height : 8 mm		height : 11 mm (4 digits), height : 10 mm (6 digits)	
Output	Relay 1 st / 2 nd : 1c, 250 V AC, 3 A (resistive load) (only 2 nd output is valid for the 1 st stage output)			
	Transistor 1 st / 2 nd : open collector, 30 V DC, 100 mA max. (only 2 nd output is valid for the 1 st stage output)			

Standard specification

Model	GF4-P	GF4-T	GF7-P	GF7-T
Power supply voltage	100 – 240 V AC 50 – 60 Hz			
Voltage fluctuation	±10 % of the power supply voltage			
Power consumption	Approx 6.2 VA	Approx 4.3 VA	GF7-P61 : Approx 7.6 VA GF7-P62 : Approx 8.7 VA	Approx 6.4 VA
Ambient temperature	-10 ~ 55 °C			
Ambient humidity	35 ~ 85 % RH			
Storage temperature	-20 ~ 65 °C			
Vibration resistance	10 – 55 Hz, peak amplitude 0.75 mm, 3 axis each direction, 1h			
Shock resistance	300 %, 3 times each in 3 axes each direction			
Weight	184 g	168 g	243 g	208 g

 Name of each part

GF4

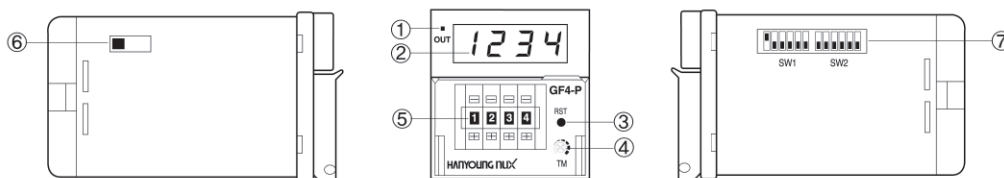

Number	Name	Description
①	Output action LED	Light ON when control output is ON
②	Computation/Time displaying unit	Display the computed value in counter action, display the action time in timer action
③	Reset key	Reset the computed value of counter or operation time of counter, Applied when changing the counter and timer action specification
④	TM volume	Set the operation time of control output by the One-short time (setting range: 0.1s~12.5s)
⑤	Digital switch	Set the computed value of counter or operation time of timer
⑥	PNP/NPN input switch	PNP/NPN input selectable by the deep switch
⑦	Function setting (SW1)	DOWN/UP, power backup memory/power reset, input mode (timer range), timer/counter
	Function setting(SW2)	Computation speed, decimal points, ON-DELAY / OFF-DELAY, output mode selectable

GF7

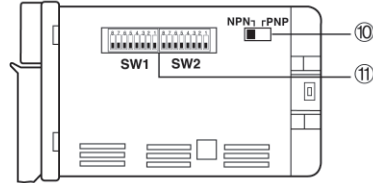
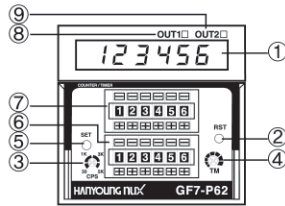

C

Counter /
Timer

Number	Name	Description
①	Computation/time displaying unit	Display the computed value in counter action, display the action time in timer action
②	Reset key	Initialize the computed value or timer operation time of counter, Applied when changing the counter and timer action specification
③	CPS(Computation speed setting volume)	Counter computing speed selectable (30 cps, 1 Kcps, 3 Kcps, 5 Kcps)
④	TM volume	Set the operation time of control output by the One-short time (setting range: 0.1s~12.5s)
⑤	SET key	Used when setting the free-scale
⑥	2 nd stage set value setting switch	2 nd stage computation set value setting switch (time setting in case of timer)
⑦	1 st stage set value setting switch	1 st stage computation set value setting switch (time setting in case of timer)
⑧	1 st stage output display LED	Light ON with 1 st stage output action
⑨	2 nd stage output display LED	Light ON with 2 nd stage output action
⑩	PNP/NPN input switch	PNP/NPN input selectable by the deep switch
⑪	Function setting (SW1)	OFF-DELAY/ON-DELAY, DOWN/UP, power backup memory/power reset, input mode (timer range), timer/counter, pre-scale selectable
	Function setting (SW2)	1 st stage output mode setting (Hold, Flicking, One-shot) 2 nd output mode setting, decimal point setting

Cautious) operate as 2nd stage setting with 1st stage setting type

Function setting

GF4

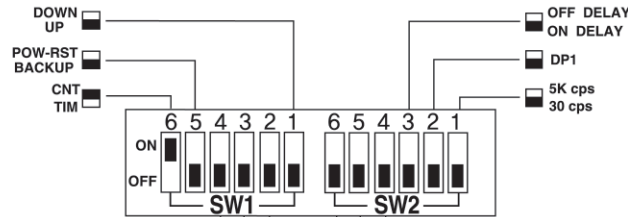

TIM	CNT	4	3	2	6	5	4	TIM	CNT
99.99s	U-A (R)	<input type="checkbox"/>	<input type="checkbox"/>	<input type="checkbox"/>	<input type="checkbox"/>	<input type="checkbox"/>	<input type="checkbox"/>	F	F
999.9s	U-A (F)	<input type="checkbox"/>	<input type="checkbox"/>	<input type="checkbox"/>	<input type="checkbox"/>	<input type="checkbox"/>	<input type="checkbox"/>	N	N
9999s	U-B (F)	<input type="checkbox"/>	<input type="checkbox"/>	<input type="checkbox"/>	<input type="checkbox"/>	<input type="checkbox"/>	<input type="checkbox"/>	C	C
99m 59s	U-B (R)	<input type="checkbox"/>	<input type="checkbox"/>	<input type="checkbox"/>	<input type="checkbox"/>	<input type="checkbox"/>	<input type="checkbox"/>	R	R
999.9m	Ud - A	<input type="checkbox"/>	<input type="checkbox"/>	<input type="checkbox"/>	<input type="checkbox"/>	<input type="checkbox"/>	<input type="checkbox"/>	K	K
99h 59m	Ud - B	<input type="checkbox"/>	<input type="checkbox"/>	<input type="checkbox"/>	<input type="checkbox"/>	<input type="checkbox"/>	<input type="checkbox"/>	P	P
999.9h	Ud - C	<input type="checkbox"/>	<input type="checkbox"/>	<input type="checkbox"/>	<input type="checkbox"/>	<input type="checkbox"/>	<input type="checkbox"/>	Q	Q
9999h	Ud - C	<input type="checkbox"/>	<input type="checkbox"/>	<input type="checkbox"/>	<input type="checkbox"/>	<input type="checkbox"/>	<input type="checkbox"/>	A	S

Switch classification	Name	Description
SW1	1	DOWN/UP ON : DOWN OFF : UP
	2	Counter input mode (timer range) Select the input mode of counter or time range of timer by ON/OFF the switch number 2, 3 and 4. ※ Input mode in the GF4 8 pin type is limited into 2 types (UP A(R) and UP A(F)) (1 computed input signal)
	3	
	4	
	5	POW-RST/BACK-UP ON : Power reset (POW-RST) OFF : Power backup memory (BACK UP)
	6	CNT/TIM ON : Counter (CNT) OFF : Timer (TIM)
SW2	1	30 cps / 5 K cps ON : 5 K cps OFF : 30 cps counter computing speed selectable
	2	Decimal point selectable ON : 888.8 OFF : 8888
	3	OFF-DELAY/ON-DELAY ON : OFF-DELAY OFF : ON-DELAY
	4	Output mode selectable Select the output mode by ON/OFF the switch number 4, 5 and 6 SW2 (UP/DOWN each 8 kinds)
	5	
	6	

GF7

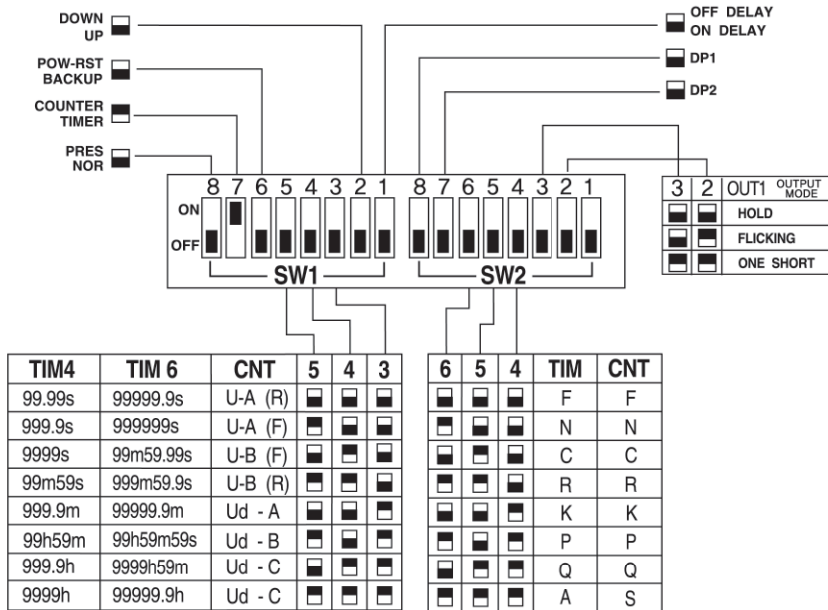

C
Counter /
Timer













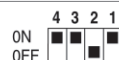

Switch classification	Name	Description
SW1	1	OFF-DELAY/ ON-DELAY ON : OFF-DELAY OFF : ON-DELAY
	2	DOWN/UP ON : DOWN OFF : UP
	3	Counter input mode (timer range) Select the input mode of counter or time range of timer by ON/OFF the switch number 2, 3 and 4. SW1
	4	
	5	
	6	POW-RST/ BACK-UP ON : Power reset (POW-RST) OFF : Power backup memory (BACK UP)
	7	CNT/TIM ON : Counter (CNT) OFF : Timer (TIM)
	8	PRES/NOR ON : PRES (Free-scale setting mode selectable) OFF : NOR (Free-scale mode lock selectable)
SW2	1	- None
	2	1 st stage (OUT1)
	3	output mode setting 1 st stage (OUT1) output mode setting within 2 nd stage setting type timer function ※ Hold, Flicking (ON : 0.5sec, OFF : 0.5sec), One-shot (0.5sec fixation)
	4	output mode selectable 2 nd stage output mode with the 2nd stage setting type counter 1 st output mode setting with the 1st setting type counter
	5	
	6	
	7	Decimal point digits setting Position of decimal point setting by the switch composition (0~3 digits setting)
	8	

● Timer function

Selecting the timer function	Select the function by using the deep switch
Inhibit input	Processing time stops when signal is ON (20 ms min)
Changing decimal system	Select 10 decimal system or sexagesimal system for the time displaying type
Time range	Select the time range and UP/DOWN indication by the deep switch (8 kinds)
Output action	F, N, C, R, K, P, Q, A (selection done by the deep switch)
Total timer indication	Indicated as the F, K output action mode
Output type	Select ON-Delay/OFF-Delay by the deep switch
Indication when reset	Up-0, Down-set value
1 st stage (OUT1) output mode setting	1 st stage (OUT1) output mode setting within 2 nd stage setting type timer(GF7) function * Hold, Flicking (ON : 0.5sec, OFF : 0.5sec), One-shot (0.5sec fixed)

● Timer range selection

GF4

SW1	UP mode	SW1	DOWN mode
ON OFF 	99.99 s	ON OFF 	99.99 s
ON OFF 	999.9 s	ON OFF 	999.9 s
ON OFF 	9999 s	ON OFF 	9999 s
ON OFF 	99 m 59 s	ON OFF 	99 m 59 s
ON OFF 	999.9 m	ON OFF 	999.9 m
ON OFF 	99 h 59 m	ON OFF 	99 h 59 m
ON OFF 	999.9 h	ON OFF 	999.9 h
ON OFF 	9999 h	ON OFF 	9999 h

(Cautious)

0 is displayed when Reset signal is inputted in the UP mode

Set value is displayed when Reset signal is inputted in the DOWN mode

Time range of GF4 socket type is same as GF4 terminal type

GF7

SW1	UP mode		SW1	DOWN mode	
	4 digits time range	6 digits time range		4 digits time range	6 digits time range
ON OFF	99.99 s	99999.9 s	ON OFF	99.99 s	99999.9 s
ON OFF	999.9 s	999999 s	ON OFF	999.9 s	999999 s
ON OFF	9999 s	99 m 59.99 s	ON OFF	9999 s	99 m 59.99 s
ON OFF	99 m 59 s	999 m 59.9 s	ON OFF	99 m 59 s	999 m 59.9 s
ON OFF	999.9 m	99999.9 m	ON OFF	999.9 m	99999.9 m
ON OFF	99 h 59 m	99 h 59 m 59 s	ON OFF	99 h 59 m	99 h 59 m 59 s
ON OFF	999.9 h	9999 h 59 m	ON OFF	999.9 h	9999 h 59 m
ON OFF	9999 h	99999.9 h	ON OFF	9999 h	99999.9 h

(Cautious)

0 is displayed when Reset signal is inputted in the UP mode

Set value is displayed when Reset signal is inputted in the DOWN mode

C

Counter /
Timer

● Counter input action

GF4

■ GF4-P41N / GF4-T40N

Caution) 'A' requires at least the min signal width and 'B' requires at least the half of min signal width.
 Caution) The following input logic of counter input mode is for the 'PNP' mode.
 Caution) When input logic is set as the 'NPN' mode, please use it as reverse of the 'PNP' mode.

- Rising state of the Input signal (\uparrow)
- Falling state of the Input signal (\downarrow)

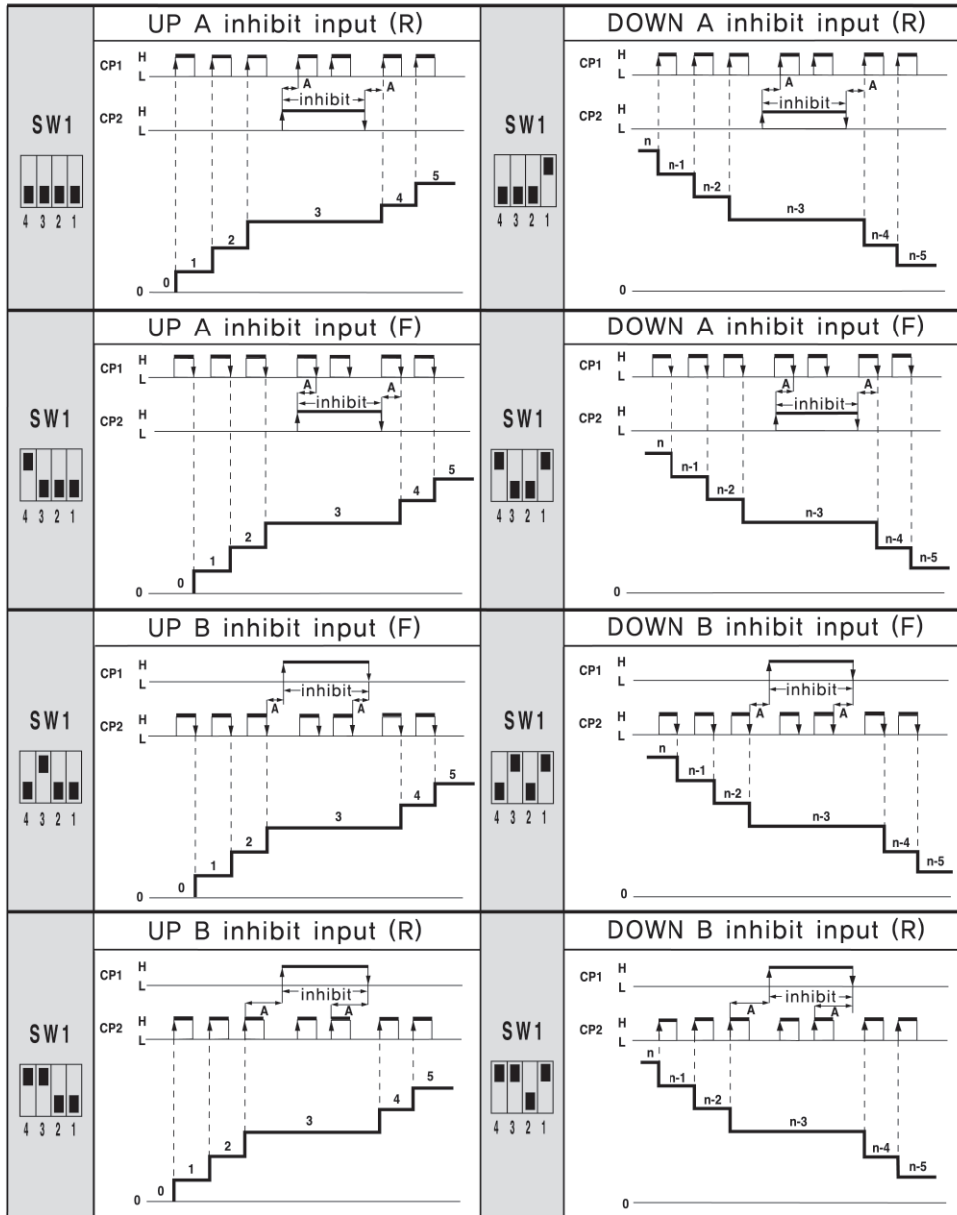

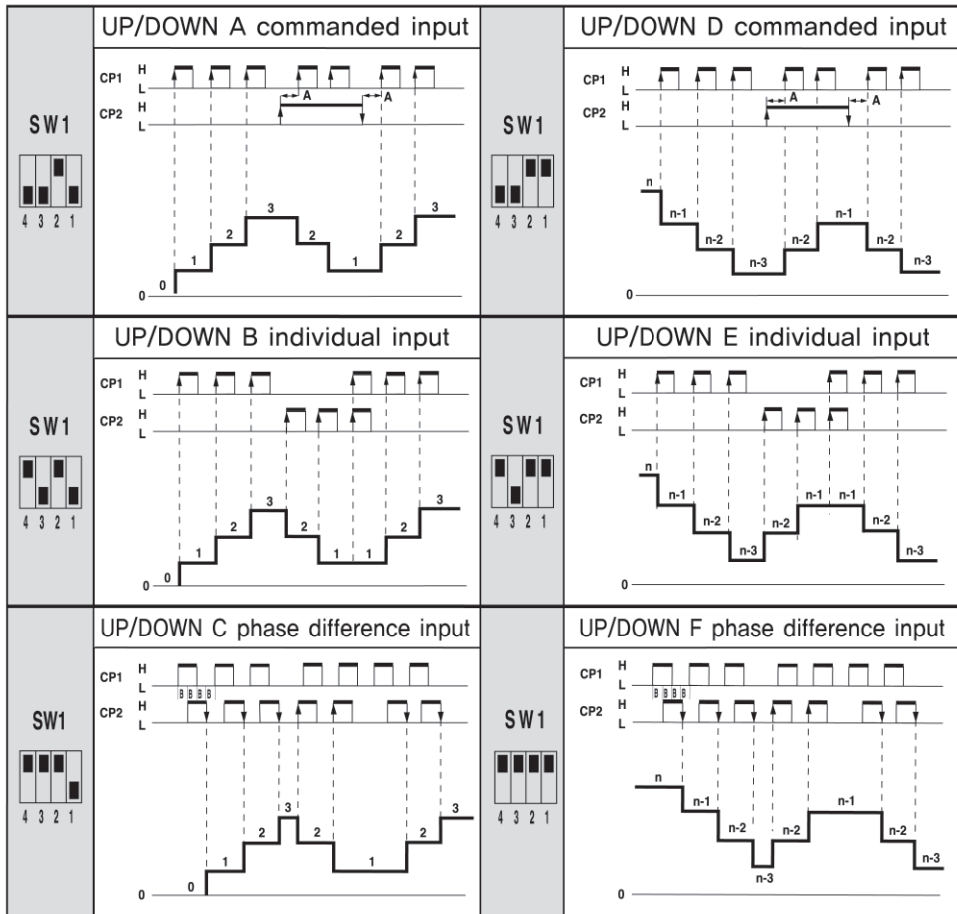

■ GF4-P41S

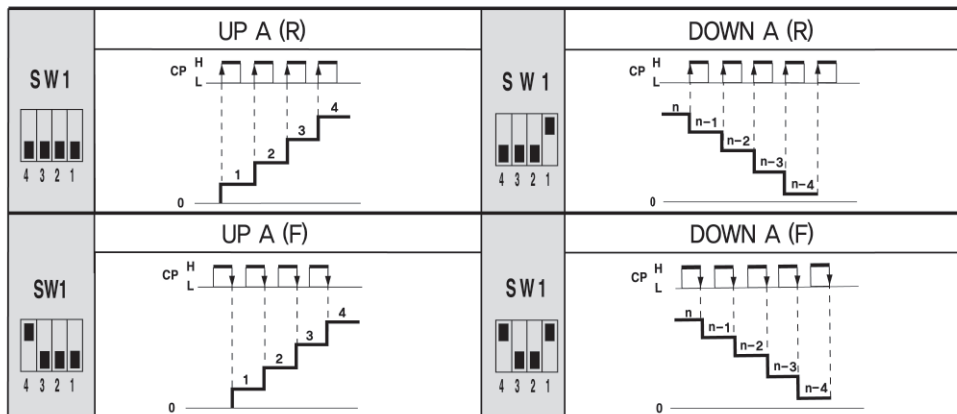

● Counter input action

GF7

Caution) 'A' requires at least the min signal width and 'B' requires at least the half of min signal width.

Caution) The following input logic of counter input mode is for the 'PNP' mode.

Caution) When input log is set as the 'NPN' mode, please use it as reverse of the 'PNP' mode.

• Rising state of the Input signal (\uparrow)

• Falling state of the Input signal (\downarrow)

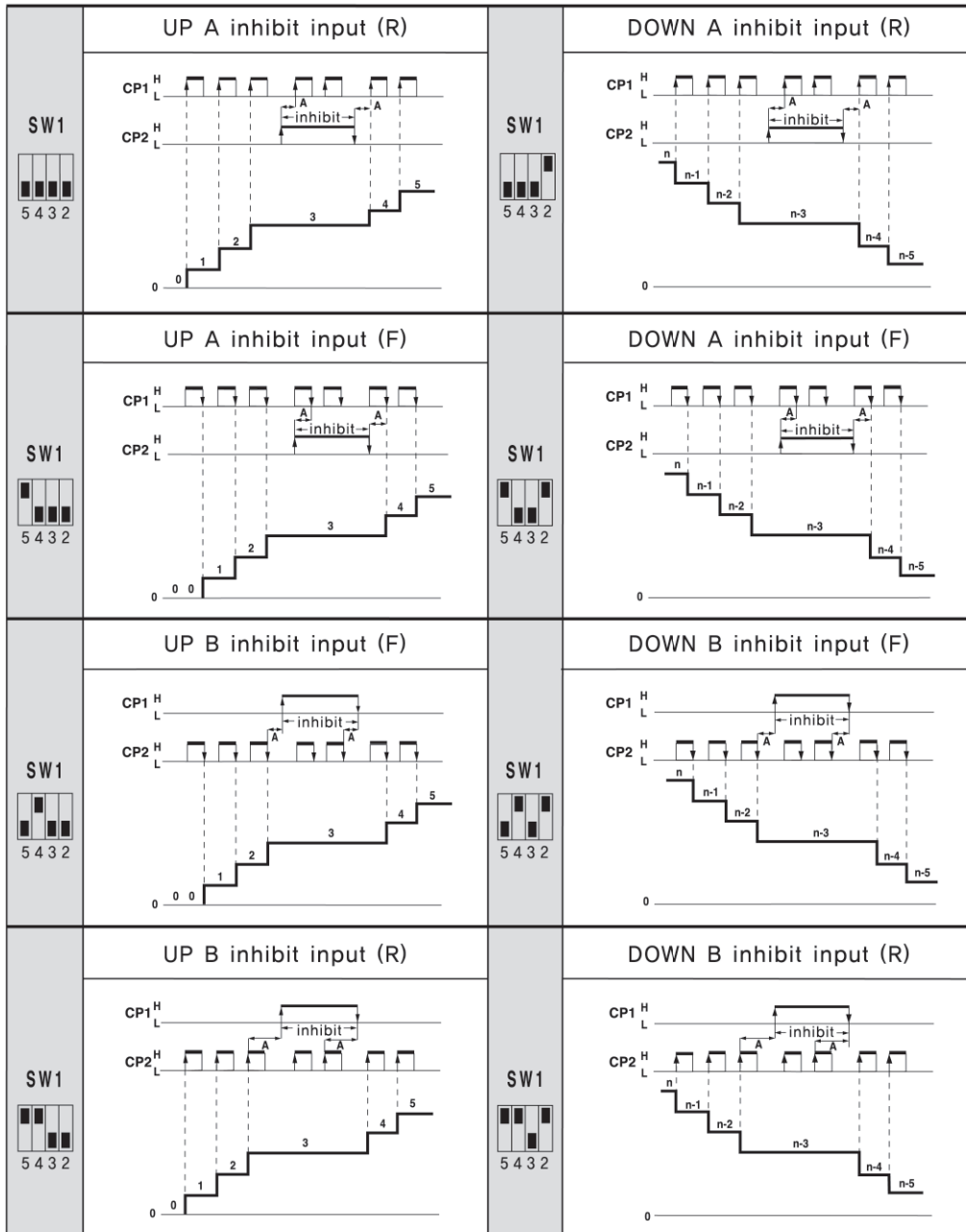

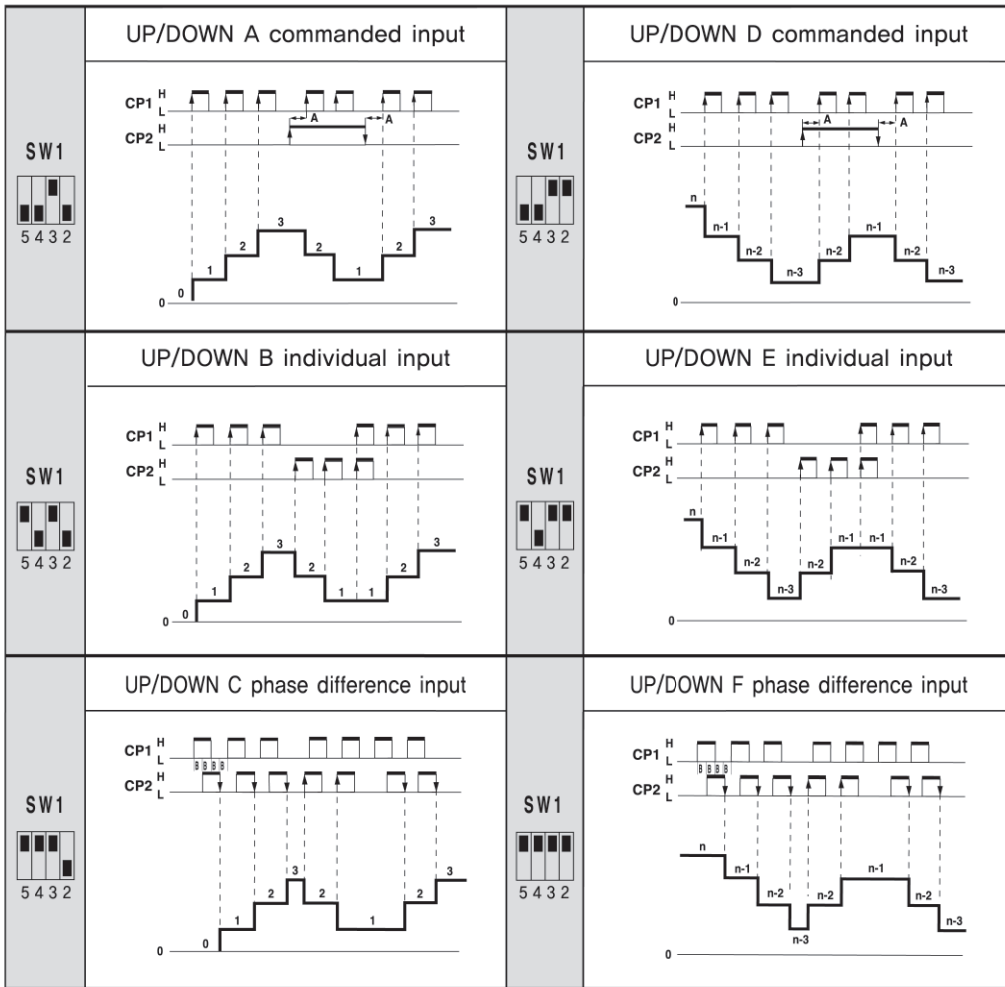

● Counter output operation

GF4



Self-maintaining output



ONE-SHOT output (0.1 ~ 12.5 sec setting)

C

Counter / Timer

Input mode		Up mode	Down mode	Operation explanation
Output mode	F SW 2 6 5 4 Counter / Timer			<ul style="list-style-type: none"> Disregarding the output occurrence, indicated value will continuously increase or decrease. Until reset signal is applied in, indicated value will continuously increase or decrease and output state will be maintained.
	N SW 2 6 5 4 Counter / Timer			<ul style="list-style-type: none"> Indicated value will not be displayed once the output is generated. Until Reset signal is applied in, indicated value and output state will be maintained.
	C SW 2 6 5 4 Counter / Timer			<ul style="list-style-type: none"> Indicated value will be initialized the output is generated. Output state will be maintained for the output set time. Output will be initialized once the output set time is elapsed. Disregarding the set time of output, indicated value will continuously increase or decrease.
	R SW 2 6 5 4 Counter / Timer			<ul style="list-style-type: none"> Indicated value will not be displayed once the output is generated. Output state will be maintained for the output set time Indicated value and output will be initialized once the output set time is elapsed.
	K SW 2 6 5 4 Counter / Timer			<ul style="list-style-type: none"> Disregarding the output occurrence, indicated value will continuously increase or decrease. Output state will be maintained for the output set time. After passing the output set time, output will be initialized without indicated value being changed.

<p>P</p>	<p>SW2 6 5 4 Counter / Timer</p>			<ul style="list-style-type: none"> Indicated value will not be displayed once the output is generated and computed value will be initialized. Output state will be maintained for the output set time and computed value will continuously increase, decrease or stop. Output will be initialized after passing the output set time and the increased or decreased computation value will be displayed.
<p>Q</p>	<p>SW2 6 5 4 Counter / Timer</p>			<ul style="list-style-type: none"> Disregarding the output occurrence, indicated value will either be increased or decreased continuously. Output state will be maintained for the output set time. Indicated value and output will be initialized after passing the output set time.
<p>S</p>	<p>SW2 6 5 4 Counter</p>			<ul style="list-style-type: none"> When using the UP mode and if the indicated value is higher than the set value then output will be generated and if the indicated value is lower than the set value then output state will be maintained. When using the DOWN mode and if the indicated value is lower than 0 then output will be generated and if indicated value is higher than 0 then output will be initialized. If Reset signal is applied in, indicated value and output will be initialized.
<p>A</p>	<p>SW2 6 5 4 Timer</p>			<ul style="list-style-type: none"> When using the UP mode and if indicated value is higher than the set value then output will be reversed and indicated value will be initialized. When using the DOWN mode and if indicated value is lower than 0 then output will be reversed and indicated value will be initialized. If Reset signal is applied in, indicated value and output will be initialized.

● Counter output action

GF7

(Cautious) Model GF7-P61/P41 operate as the 2nd stage output (OUT2).

(Cautious) Setting the "number 2 of DIP SW2" as "ON" will make 1st stage output(OUT1) to operate as "Flickering(ON-0.5sec, OFF-0.5sec) output", (But number 3 of DIP SW2 must be in OFF state)



Counter / Timer

Input mode		Up mode	Down mode	Operation explanation
Output mode	F SW2 6 5 4 Counter / Timer			<ul style="list-style-type: none"> Disregarding the 2nd stage output occurrence, the indicated value continuously increases or decreases and output state is maintained. Once the Reset signal is supplied in, indicated value and output will be initialized.
				<ul style="list-style-type: none"> Indicated value will not be displayed once the 2nd stage output is generated and output state will be maintained. Once Reset signal is supplied in, indicated value and output will be initialized.
				<ul style="list-style-type: none"> Indicated value will not be displayed once the 2nd stage output is generated and output state will be maintained. Output state will be maintained for the output set time and output will be initialized once it passes the output set time. 1st stage output will be initialized synchronously with the 2nd stage output. Runs above operations repeatedly without supplying in the Reset signal.
				<ul style="list-style-type: none"> Indicated value will not be displayed once the 2nd stage output is generated and output state will be maintained. Output state will be maintained for the output set time and indicated value and output will be initialized after passing the output set time. 1st stage and 2nd stage output will be initialized at the same time. Runs above operations repeatedly without supplying in the Reset signal.

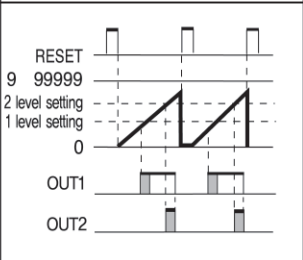
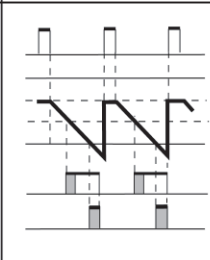
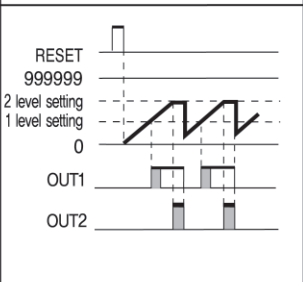
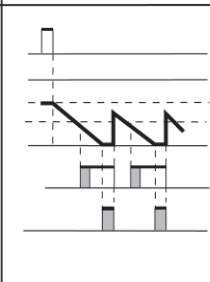
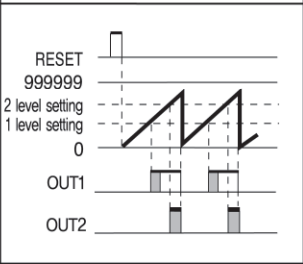
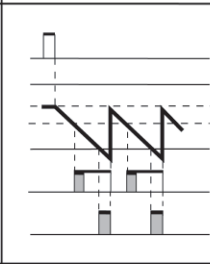
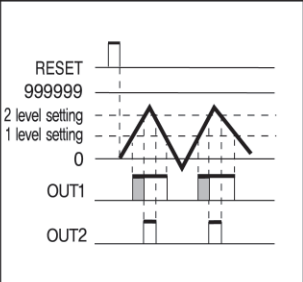
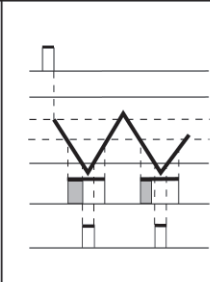
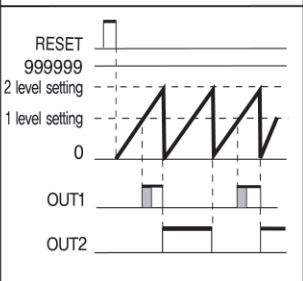
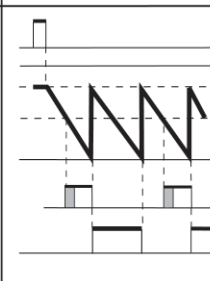
<p>K</p>	<p>SW2</p> <p>6 5 4</p> <p>Counter / Timer</p>	<p>RESET</p> <p>9 99999</p> <p>2 level setting</p> <p>1 level setting</p> <p>0</p> <p>OUT1</p> <p>OUT2</p> 		<ul style="list-style-type: none"> Disregarding the 2nd stage output occurrence, indicated value will continuously increase or decrease. Output state will be maintained for the output set time and once passing the set time, only the output will be initialized. (output state will not be changed) 1st stage and 2nd stage output will be initialized at the same time. When Reset signal is supplied in, indicated value and output will be initialized.
<p>P</p>	<p>SW2</p> <p>6 5 4</p> <p>Counter / Timer</p>	<p>RESET</p> <p>999999</p> <p>2 level setting</p> <p>1 level setting</p> <p>0</p> <p>OUT1</p> <p>OUT2</p> 		<ul style="list-style-type: none"> Indicated value will not be displayed once the 2nd stage output is generated and the computed value will be initialized. Output state will be maintained for the output set time and computed value will continuously increase or decrease without indicated value being changed. Output will be initialized after passing the output set time and the increased/decreased computation value will be displayed. 1st stage and 2nd stage output will be initialized at the same time
<p>Q</p>	<p>SW2</p> <p>6 5 4</p> <p>Counter / Timer</p>	<p>RESET</p> <p>999999</p> <p>2 level setting</p> <p>1 level setting</p> <p>0</p> <p>OUT1</p> <p>OUT2</p> 		<ul style="list-style-type: none"> Disregarding the 2nd stage output occurrence, indicated value will continuously increase or decrease Output state will be maintained for the output set time and indicated value/output will be initialized after passing the output set time 1st stage and 2nd stage output will be initialized at the same time.
<p>S</p>	<p>SW2</p> <p>6 5 4</p> <p>Counter</p>	<p>RESET</p> <p>999999</p> <p>2 level setting</p> <p>1 level setting</p> <p>0</p> <p>OUT1</p> <p>OUT2</p> 		<ul style="list-style-type: none"> When using the UP mode, 1st stage output will be generated if the indicated value is higher than the 1st stage set value and 1st stage output will be initialized if the indicated value is lower than the 1st stage set value, 2nd stage output will be generated if the indicated value is higher than the 2nd stage set value and will be initialized if lower than the 2nd stage set value. When using the DOWN mode, 1st stage output will be generated if the indicated value is lower than the 1st stage set value and if higher than the 1st stage output then it will initialize the indicated value, 2nd stage output will be generated if the indicated value is lower than 0, and if higher than 0, it will initialize the 2nd stage output.
<p>A</p>	<p>SW2</p> <p>6 5 4</p> <p>Timer</p>	<p>RESET</p> <p>999999</p> <p>2 level setting</p> <p>1 level setting</p> <p>0</p> <p>OUT1</p> <p>OUT2</p> 		<ul style="list-style-type: none"> when using the UP mode, 2nd stage output will be reversed if the indicated value is higher than the 2nd stage set value and indicated value will be initialized when using the DOWN mode, 2nd stage output will be reversed if the indicated value is lower than 0 and indicated value will be initialized 1st stage output will be generated when 2nd stage output is in "OFF" state and the indicated value is higher than the 1st stage set value.

Pre-Scale Setting type (Limits with GF7-P)

What is Pre-scale function?

- This is the function that computes the number of input signal and converts into the certain numerical value.

Example of usage depending on the pre-scale setting

Example) By using the 6 digits counter, users want to display 0.09425 regarding the single input signal by setting the pre-scale value.

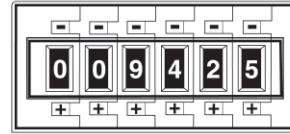

〈 Front digital switch 〉

- Set the front side switch "DIP SW1 number 7" to the ON direction in order to select as counter.
- Set the front side switch "DIP SW1 number 8" to the ON direction in order to select as pre-scale mode.
- Set #7 and #8 of deep switch SW2 as ON and press the reset (RST) key in order to set the counter display value and counter set value as 3 decimal points mode.
- Pressing the front SET key will shift the position of decimal points so set the position of decimal point of pre-scale value to the 5th position.
- Set the front digital switch as 0.09425 and press the reset (RST) switch to complete the pre-scale value setting.

Default specification setting

Model	GF4	GF7	Reference
Position of the decimal point	none	none	Counter function
Counter/timer function	counter	counter	-
Pre-scale setting	no function	1 : 1	Counter function
Power backup memory	power backup	power backup	-
Computation speed	30 cps	30 cps	Counter function
Output type	ON Delay	ON Delay	-
Input action mode	U-A(R)	U-A(R)	-
Output action mode	F	F	-
2nd stage setting OUT1 output	no function	Hold	-
Auto reset time	100 ms	50 ms	Counter function

Dimension and panel cutout (unit : mm)

GF4

Dimension

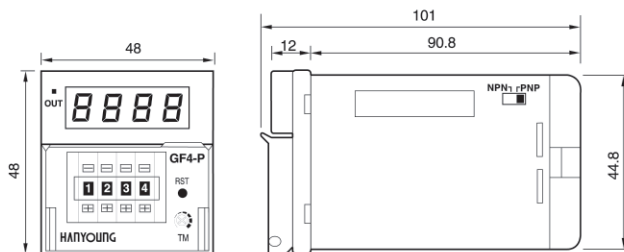

Panel cutout

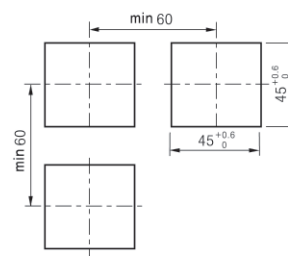

GF4-P41S

● Dimension

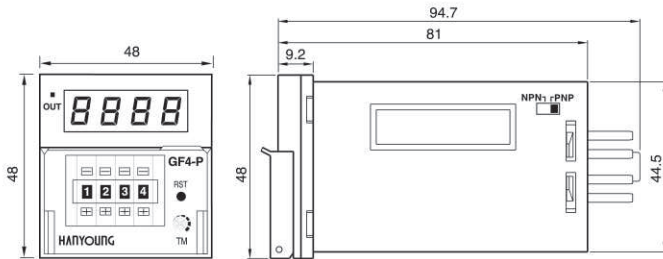

● Panel cutout

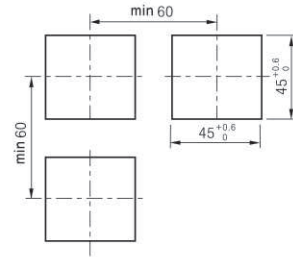

C
Counter /
Timer

GF7

● Dimension

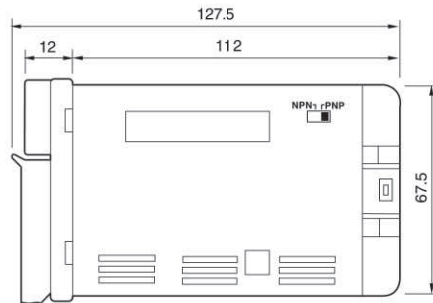
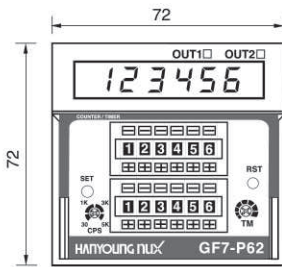

● Panel cutout

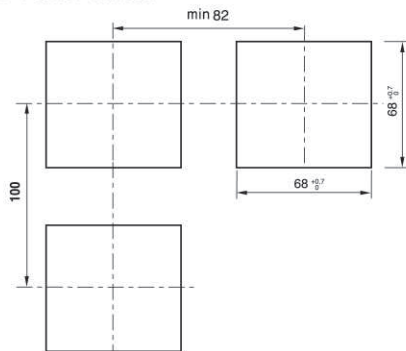

Connection diagram

※ Voltage / Non-voltage selection by the deep switch

GF4-P41

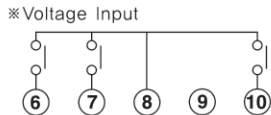
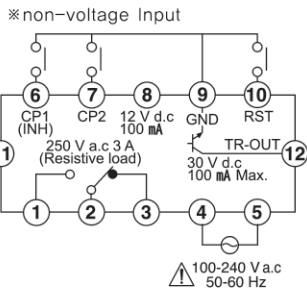

GF4-T40

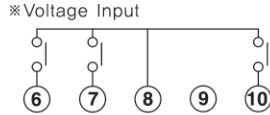
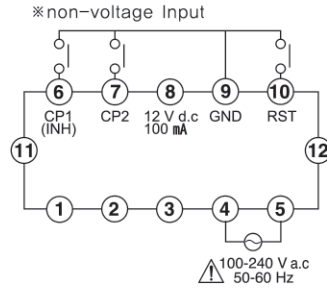

GF4-P41S

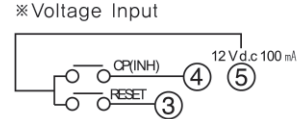
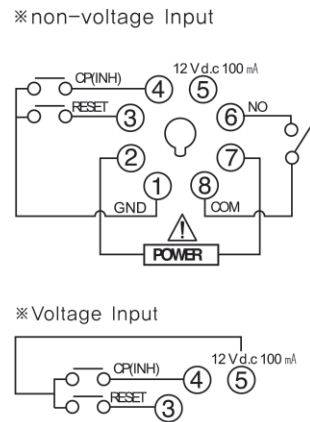

GF7-P41, GF7-P61

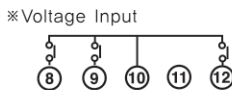
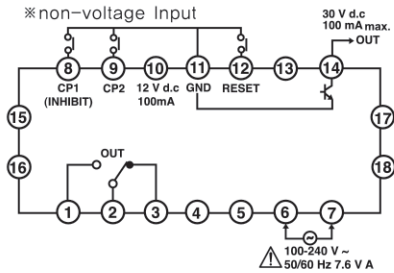

GF7-P42, GF7-P62

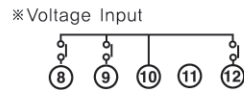
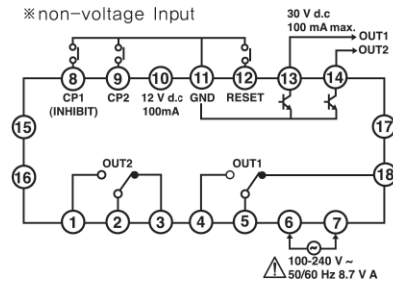

GF7-T60

