

Counter / Timer

GE Series

INSTRUCTION MANUAL

Thank you for purchasing HANYOUNG NUX CO.,Ltd. Product.
Please check whether the product you purchased is the exactly same as you ordered. Before using product, please read instruction manual carefully.



HEAD OFFICE 1381-3, Juan-Dong, Nam-Gu Incheon, Korea
TEL: (82-32)876-4697 FAX: (82-32)876-4696

Safety Information

Before you use, read safety precautions carefully, and use this product properly. The precautions described in this manual contains important contents related with safety; therefore, please follow the instructions accordingly. The precautions are composed of DANGER, WARNING and CAUTION.

DANGER

Do not touch or contact the input/output terminals because they may cause electric shock.

WARNING

1. If there is a possibility of an accident caused by errors or malfunctions of this product, install external protection circuit to prevent the accident.
2. This product does not contain an electric switch or fuse, so the user needs to install a separate electric switch or fuse externally. (Fuse rating : 250 V 0.5 A)
3. To prevent defecation or malfunction of this product, supply proper power voltage in accordance with the rating.
4. To prevent electric shock or devise malfunction of this product, do not supply the power until the wiring is completed.
5. Since this product is not designed with explosion-protective structure, do not use it at any place with flammable or explosive gas.
6. Do not decompose, modify, revise or repair this product. This may cause malfunction, electric shock or fire.
7. Reassemble this product while the power is off. Otherwise, it may cause malfunction or electric shock.
8. If you use the product with methods other than specified by the manufacturer, there may be bodily injuries or property damages.
9. Due to the danger of electric shock, use this product installed onto a panel while an electric current is applied.

CAUTION

1. The contents of this manual may be changed without prior notification.
2. Before using the product you have purchased, check to make sure that it is exactly what you ordered.
3. Check to make sure that there is no damage or abnormality of the product during delivery.
4. Do not use this product at any place with corrosive(especially noxious gas or ammonia) or flammable gas.
5. Do not use this product at any place with direct vibration or impact.
6. Do not use this product at any place with liquid, oil, medical substances, dust, salt or iron contents. (Pollution level 1 or 2)
7. Do not polish this product with substances such as alcohol or benzene.
8. Do not use this product at any place with excessive induction trouble, static electricity or magnetic noise.
9. Do not use this product at any place with possible thermal accumulation due to direct sunlight or heat radiation.
10. Install this product at place under 2,000m in altitude.
11. When the product gets wet, the inspection is essential because there is danger of an electric leakage or fire.
12. If there is excessive noise from the power supply, using insulating transformer and noise filter is recommended. The noise filter must be attached to a panel grounded, and the wire between the filter output side and power supply terminal must be as short as possible.
13. If gauge cables are twisted closely, the effect on noise may occur.
14. Do not connect anything to the unused terminals.
15. After checking polarity of terminal, connect wires at the correct position.
16. When this product is connected to a panel, use a circuit breaker or switch approved with IEC847-1 or IEC947-3.
17. Install the circuit breaker or switch at near place for convenient use.
18. For the continuous and safe use of this product, the periodical maintenance is recommended.

19. Some parts of this product have limited life span, and others are changed by their usage.
20. The warranty period for this product including parts is one year if this product is properly used.
21. When the power is on, the preparation period of contact output is required. In case of use for signals of external interlock circuit, use with a delay relay.

Model and Suffix code

Model		Description
GE	□ □ □ □ □ □	Digital Batch Counter
Appearance	GE3	S(W)96.0 × (H)48.0 × (L)107.6 mm
	GE4	(W)48.0 × (H)48.0 × (L)84.0 mm
	GE6	(W)72.0 × (H)36.0 × (L)81.0 mm
	GE7	(W)72.0 × (H)72.0 × (L)87.0 mm
Type	P	PRESET · BATCH
	T	TOTAL (Indicator)
Digit	4	4 : 9999 (4 digit) ※ GE3,GE7:Not available
	6	6 : 999999 (6 digit)
Stage	1	1 stage
	2	2 stage ※ Twin timer Support
Power supply	A	100 V - 240 V a.c
	D	24 V - 60 V d.c

Power Supply

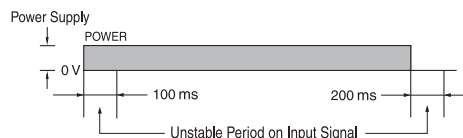

During the first 100 ms after power input and first 200 ms after power opening, it is consider as ascend and descend time of internal power and external output power. Therefore, it does not operate during unstable period in order to prevent from malfunction which is caused by unstable output operation of external sensor

- ※ Supply signal only after 100 ms following the power input.
- ※ Supply power only after 200 ms following the power shutdown.

Dimensions & Panel Cutout

[Unit : mm]

GE7

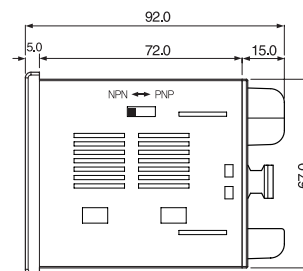
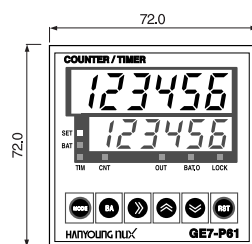

GE4

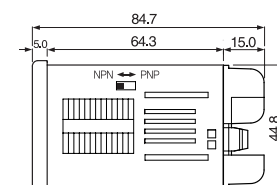
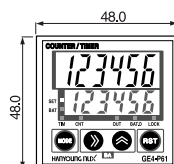

■ GE6

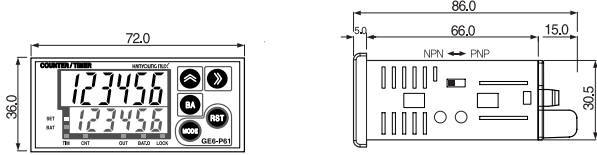

■ GE3

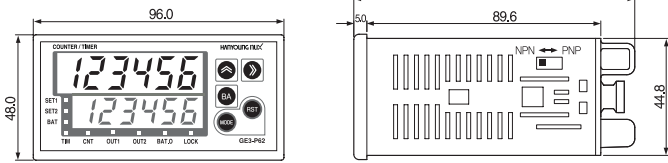

■ Panel Cutout

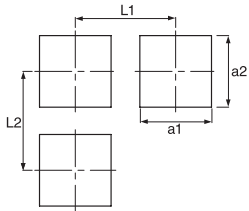

	GE4	GE6	GE3	GE7
a1	45 ^{+0.6} ₀	66.5 ^{+0.5} ₀	92 ^{+0.5} ₀	68 ^{+0.7} ₀
a2	Same as above	32 ^{+0.5} ₀	45 ^{+0.5} ₀	Same as above
L1	More than 60	More than 90	More than 130	More than 82
L2	Same as above	More than 57	More than 60	Same as above

■ Specification

Model		GE4	GE6	GE3	GE7	
Power voltage	a.c	100 - 240 V a.c (50 - 60 Hz) ±10 %				
	d.c	24 - 60 V d.c / a.c (50 - 60 Hz) ±10 %				
Power consumption	a.c	Max. 13.5 V a.c		Max. 13.5 V a.c		
	d.c	Max. 9 VA		Max. 9 VA		
FND height		11 mm		13 mm		
		8 mm		10 mm		
Counting speed and input	1 cps / 30 cps / 1 K cps / 10 K cps Contact/Non-contact					
Memory for power failure.	10 years (Nonvolatile memory)					
Input	CP1, CP2, RESET, BATCH RESET (exclude TOTAL) 4inputs [H] level 4 - 30 V d.c, [L] level 0 - 2 V d.c Internal pull up/pull down resistance connection due to NPN/PNP setup					
Min input signal	Counter	External reset Min. input signal range: select among 0.1ms / 1ms / 20 ms				
	Timer	START, INHIBIT, RESET Min. input signal range: select either 1ms / 20 ms				
External output power	a.c	12 V d.c (±5 %) 200 mA Max.				
	d.c	12 V d.c (±5 %) 100 mA Max.				
ONE SHOT output	0.01-99.99 s [OUT1, OUT2(OUT)]					
Control output	contact	1 step	1c (OUT)	1a (OUT)	1c (OUT)	
		2 step	1a (OUT1), 1c (OUT2)			
	Non-contact	Capacity	NO contact: 250V a.c 3A resistance load, NC contact: 250V a.c 2A resistance load			
		1 step	NPN 2 points(OUT,BAT.O)			
		2 step	-			
		Capacity	Open collector 30 V d.c 100 mA Max.			
Timer operation	Comparative cycle: repeated setup error less than 5 mS for every 2 mS Stable time: 100 mS stable time when POWER ON					
Dielectric Strength	2000 V a.c 50 - 60 Hz for 1 minute					
Insulation Resistance	Min 100 MΩ (Based on 500 V d.c)					
Withstanding noise	Square wave noise by noise simulator (1 μS pulse per 16ms) ±2 kV (Power supply input terminal)					
Vibration	Malfunction	10 - 55 Hz (for 1 min period) double amplitude 0.5mm X.Y.Z each direction for 10 minutes				
	Durability	10 - 55 Hz (for 1 min period) double amplitude 0.5mm X.Y.Z each direction for 2 hours				
Shock	Malfunction	100 mS (About 10G)				
	Durability	300 mS (About 30G)				
Relay	Electrical	Min. 100 thousand times (250 V a.c 2 A resistance load)				
	Mechanical	Min 1 million times				
Protection structure	IP65 (Front part only)					
Ambient temperature	-20 ~ 65 °C (Non freezing state)					
Ambient humidity	-10 ~ 55 °C, 35 ~ 85 % R.H. (No freezing or decondensation)					
Weight	Max.133 g	Max.138 g	Max.203 g	Max.203 g		
Certificate	CE					

※If you want to modify Input and output type, please contact HANYOUNG sales office

■ Connection Diagram

• NPN Input

■ GE4-P1

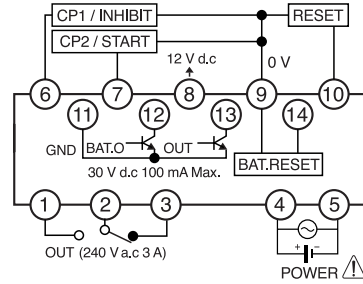

■ GE4-P2

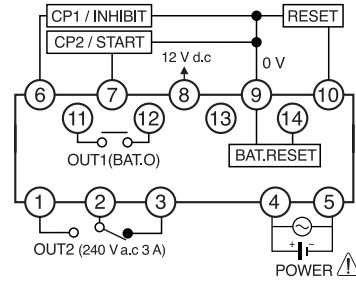

■ GE6-P1

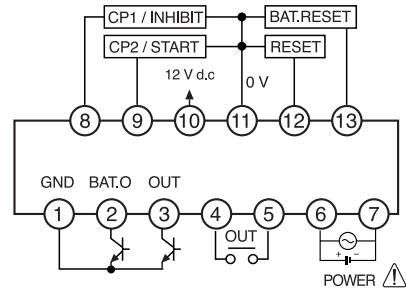

■ GE6-P2

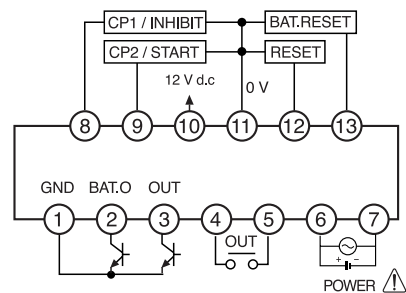

■ GE3-P1

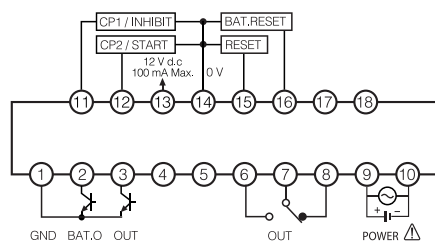

■ GE3-P2

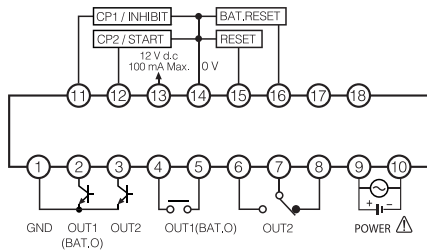

■ GE7-P1

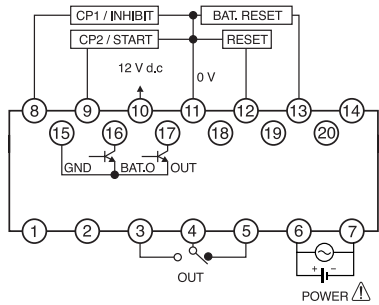

■ GE7-P2

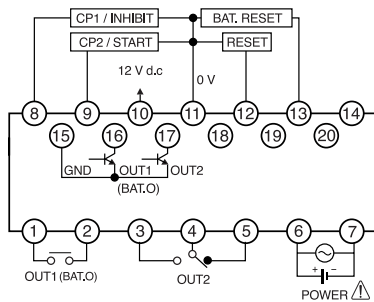

- Coefficient Input 1(CP1) / Inhibit Input (INHIBIT) Terminal
 - With using counter, it is used as coefficient input or coefficient inhibit
 - Process time become HOLD when timer function is selected
- Coefficient Input 2(CP2) / Start (START) Terminal
 - With using counter, it is used as coefficient input or coefficient inhibit
 - With using timer, it can be used as SIGNAL ON START, SIGNAL ONE START. (Refer to output mode operation)
 - (SIGNAL ON START: Timer operates only with the continuous input.)
 - (SIGNAL ONE START: Timer operates only with the supply of Input 1 Pulse.)
- BAT. RESET
 - This is used as BATCH, RESET during the use of counter / timer.
- RESET
 - This initializes the coefficient value and current time during the use of counter / timer.
- OUT, OUT2 : This is used as the counter / timer comparative output.
- BAT.O : Batch Counter Output (1 Stage Setup Type)
- OUT1(BAT.O): Select between 2 Stage Setup Output and Batch Counter Output (2 Stage Setup Type)

■ Name of Each Section

■ GE3

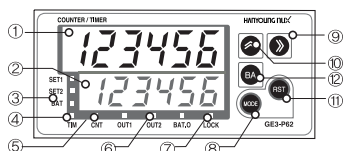

■ GE6



■ GE4

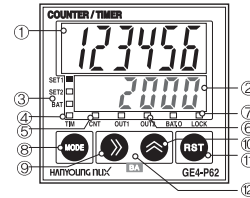

■ GE7

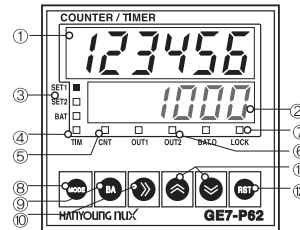

- ① Coefficient display (RED FND)
 - Display coefficient value (counter), time process value (timer), batch coefficient value and setup list.
- ② Setup display (GREEN FND)
 - Display setup value (counter), setup time (timer), batch setup value, instant output setup (batch setup is 0 in Timer) and setup contents
- ③ SET1, SET2 (SET), BAT
 - Indicates the status of coefficient section and setup section (BAT lamp corresponds to batch status.)
- ④ TIM (Timer)
 - This flashes when the timer progresses and remains lighted when the device stops from inhibit input or reset.
 - (It is indicated in Change Mode of the device during TIM/TTWIN setup.)
- ⑤ CNT (Counter)
 - This is indicated during 1CNT/2CNT setup in Change Mode of the device.
- ⑥ OUT1, OUT2(OUT), BAT.O (Output Action Indication)
 - BAT.O lights up when the batch setup value is set. (OUT1 Output)
 - BAT.O lights up and outputs when the device operates with the instant output where the batch setup value is 0 (timer).
 - CP1, CP2, RST: Verification of Input Status. (Exclusively for TOTAL)
- ⑦ LOCK:Key Lock (KEY LOCK) Action Indication This lights up during Lock Setup.
- ⑧ **MODE**: This key is for function setup Mode Entry and Mode change. It can also be used for ending after saving when changing the setup value
- ⑨ **▶**: Setup value change Entry and Location shift
- ⑩ **▲**: UP Key
- ⑪ **RST**: RESET KEY **③**When SET, BAT lamp light, RESET key will not operate.
- ⑫ **BA**: Batch and operation mode 1 stage and 2 stage conversion key. When BAT lamp light, it is batch mode and keep operate.
- ⑬ **▶** + **▲**: Push both of keys together, It operate same as **BA** key.
- ⑭ **▼**: DOWN Key

※ TOTAL Model does not have Setup Indication Section, SET1, SET2 and BAT Lamp. OUT1, OUT2, BAT.O change their use as CP1, CP2, RST Input Status Check Lamp. 1 Stage Setup Model does not have SET1 and OUT1 Lamp, and SET2 is displayed as SET and OUT2 is displayed as OUT.

■ Maximum Coefficient Speed

Maximum coefficient speed is maximum response speed when entering in the duty ratio (ON. OFF ratio) of coefficient input signal as one to one ratio (1:1)

- ① As for the input signal below the maximum coefficient speed, if either ON or OFF time is unilaterally less than the standard value of minimum signal width then it may not be counted
- ② Minimum Input Time

Coefficient Speed Selection	Minimum Input Signal
1 cps	250 ms
30 cps	11 ms
1 K cps	0.3 ms
10 K cps	0.05 ms

※ Minimum Signal Time refers to 'ON' Time.

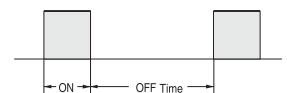

Counter Mode Setup Method

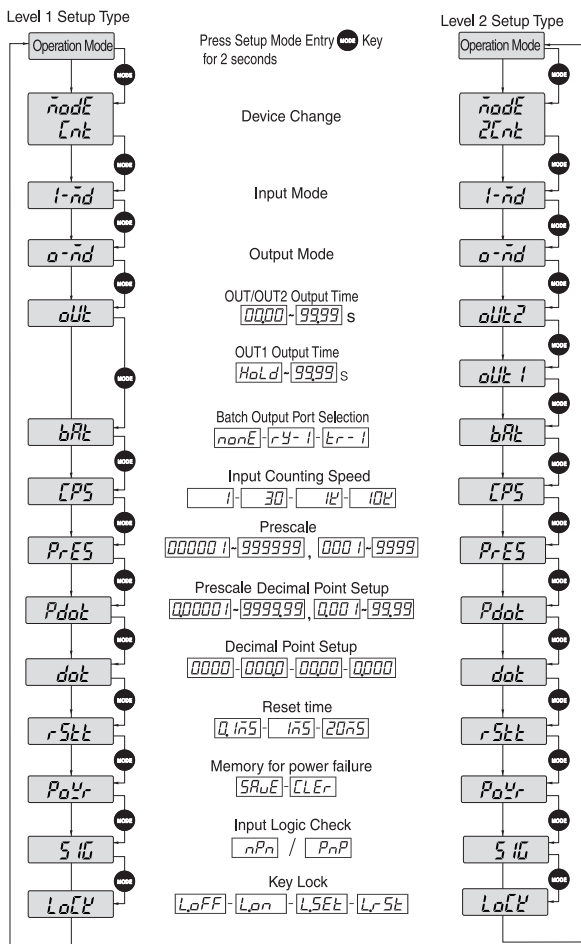

Counter input operation mode

'A' needs value greater than min signal width, B need value greater than half of min signal width.

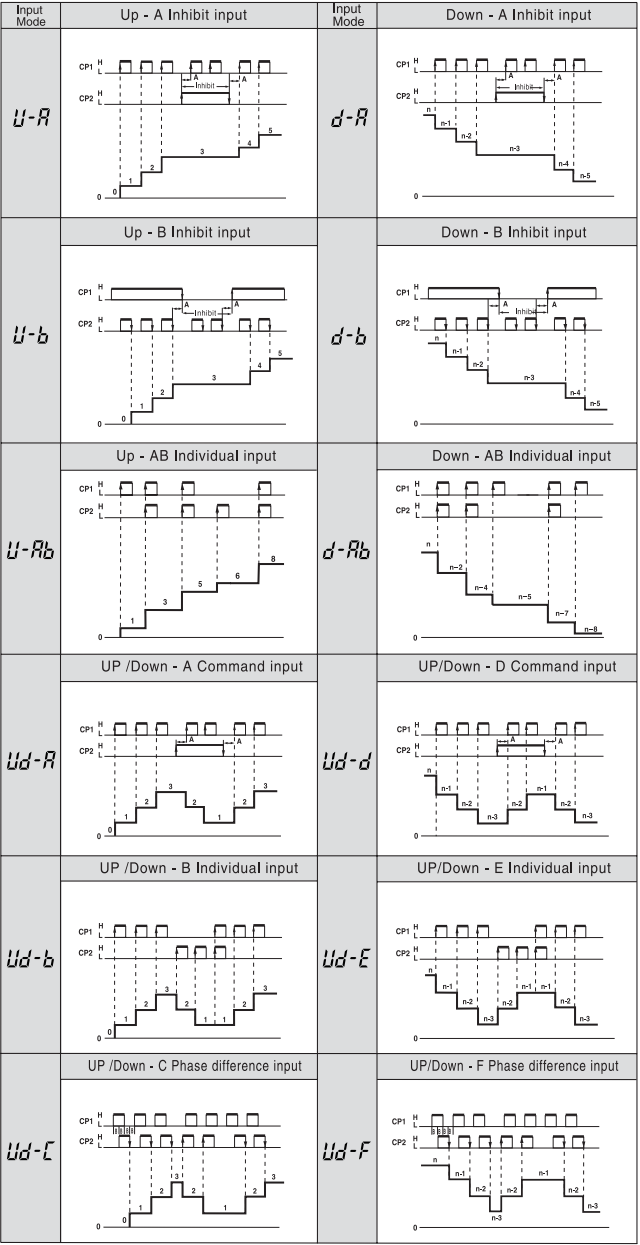

• When using encoder (incremental method). Please use Ud-E Ud-F
 Noise) The input Login of above list is PNP.

Counter Function Setup Mode Convert Operation Mode to Function Mode -> Press MD key for 2 seconds

Setup Items	Contents	Initial value
Setup list $\bar{n}odE$	$\bar{L}1\bar{n}$ - $\bar{C}nt$: 1 Stage setup type $\bar{L}1\bar{n}$ - $\bar{L}1\bar{n}$ - $\bar{2}Cnt$: 2 Stage setup type	$\bar{C}nt$: 1 Stage setup counter $\bar{2}Cnt$: 2 Stage setup counter
Input Mode $i\bar{n}d$	$\bar{U}-R$ - $\bar{d}-R$ - $\bar{U}-b$ - $\bar{d}-b$ - $\bar{U}-Ab$ - $\bar{d}-Ab$ - $\bar{U}-d$ - $\bar{d}-d$ - $\bar{U}-E$ - $\bar{d}-E$ - $\bar{U}-F$ - $\bar{d}-F$	$\bar{U}-Rb$: CP1,CP2 Dual inputs UP mode operatio $\bar{d}-Rb$: CP1,CP2 Dual inputs down mode operation # Refer to Input operation Mode (Counter)
Output Mode $o\bar{n}d$	$\bar{n}-R$ - $\bar{C}-r$ - $\bar{U}-P$ - $\bar{q}-R$	# Refer to Output operation Mode (Counter)
Output Time $oUt2$	0000 - 9999	One short delay time $\bar{n}-F$ (D setup is self-maintenance output) One short time setup $\bar{C}-r$ - $\bar{U}-P$ - $\bar{q}-R$
Output Time $oUt1$	$Hold$ - 9999	No display for level 1 product
BATCH OUTPUT bRt	$\bar{n}onE$ - $\bar{r}y$ - \bar{l} - $\bar{L}r$ - \bar{l}	Set Batch output port ($\bar{r}y$:Relay, $\bar{L}r$: Transistor)
Counting speed CPS	1 - 30 - $1k$ - $10k$	1 or 30 is set when contact is used with maximum input speed
PRESCALE $PrES$	00000 - 1 - 999999 000 - 1 - 9999	Initial Value 1000
PRESCALE Decimal Point Setup $Pdot$	0.0000 - 1 - 9999.99 0.00 - 1 - 99.99	set up to 5 decimal points and possible to move up to 4 decimal points
Setup decimal point in display dot	0000 - 0000 - 0000 - 0000	Setup decimal point in display and possible to move up to the third decimal point
RESET TIME $rStt$	$0.1s$ - $1s$ - $20ms$	Minimum signal width of external reset signal input
Memory for power failure $PaUr$	$SRuE$ - $CLER$	$SRuE$: Coefficient value is saved when POWER become OFF $CLER$: Coefficient value is initialized when POWER become OFF
Input Logic SiG	$\bar{n}Pn$ / \bar{PnP}	Vary depends on internal switch conversion
Key Lock $LoLk$	Key Lock $\bar{L}oFF$ - $\bar{L}on$ - $\bar{L}SEt$ - $\bar{L}rSt$	$\bar{L}oFF$: Cancel Key Lock $\bar{L}on$: Do not use any keys (except \bar{MD} key) $\bar{L}SEt$: Do not use \bar{R} , \bar{L} , \bar{MD} , \bar{BA} key $\bar{L}rSt$: Do not use front side \bar{RST} key

Pressing \bar{MD} key will return to operation mode without saving. Return to operation mode if there is no key input more than 60 seconds. With function setup mode, it ignores external signal input and maintains output in OFF state.

- TOTAL product does not display setup lists such as output mode, OUT2 output time, OUT1 output time, BATCH output and etc
- Level 1 setup product does not display OUT1 output time setup list.
- Selecting \bar{NONE} for BATCH output setup will restrict setup function and display function.

Counter Output operation of Exclusive Indication (GE-T)

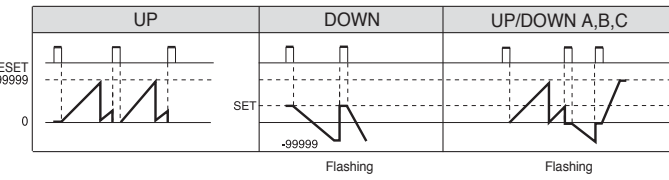

- Set value is first to decrease within Down Mode
- 6 digits: if -99999(-999), it flashes and does not get counted
- Within UP MODE, it increases to the maximum display value, initializes to 0 and increases again

Counter Output Action Mode

• As for 1 Stage Counter (OUT), it is the same as 2ND Output (OUT2) Action.

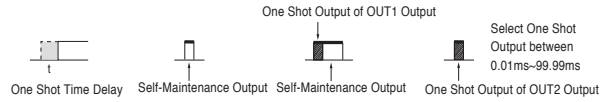

Output Mode	Input Mode			Post Count Up Action
	UP	DOWN	UP/DOWN A,B,C	
n				Coefficient value indication is maintained and setting up HOLD (0) leads to self-maintenance output. Also, setting up time leads to OUT2 output after one shot delay setup. OUT1 and OUT2 become OFF when reset and return to Start.
F				Coefficient value indication is continuously processed and setting up HOLD (0) leads to self-maintenance output. Also, setting up time leads to OUT2 output after one shot delay setup. OUT1 and OUT2 become OFF when reset and return to Start
L				Coefficient value indication is continuously processed during START state and OUT2 yields One Shot Output. Self-maintenance output of OUT1 is turned off when OUT2 is turned OFF
r				Coefficient value indication is maintained during One Shot Time, and then resets. (Repetitive Action)
L				Coefficient value indication is continuously processed. OUT2 yields one shot output. Self-maintenance output of OUT1 is turned off after one shot time of out2
P				When coefficient value returns to initial state, then coefficient value indication is maintained for one shot time. After processing one shot time, it displays processed coefficient value.
q				Coefficient value increases and OUT2 yields One Shot Output. The device is reset after the One Shot Output. (Repetitive Action)
R				Coefficient value is maintained and OUT2 yields one shot output. OUT1 and OUT2 are independent from each other. If #OUT1 is same as setup value of SET1, it leads to one shot output or self-maintenance output. (In case of Level 1 setup type, OUT1 and OUT2 are same each other) # Reset refers to OUT1 and OUT2 become OFF and coefficient value being initialized.

Input Connection

NPN (Non-Voltage Input)

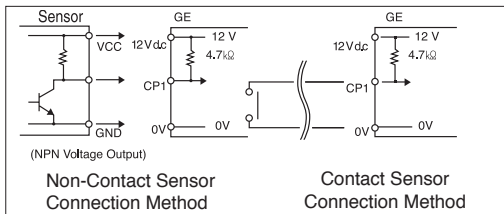

PNP (Voltage Input)

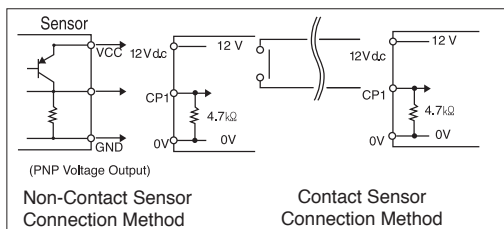

Input Logic Selection

Operate the conversion switch after confirming NPN/PNP indication which is displayed on the top

Input Method	PNP Setup	
	Voltage Input	PNP O.C
H	5 - 30 V dc	5 - 30 V dc
L	0 - 2 V dc	OPEN

Input Method	NPN Setup	
	Voltage Input	PNP O.C
H	0 - 2 V d.c	0 - 2 V d.c
L	5 - 30 V d.c	OPEN

※ For receiving Open Collector Input, Input Logic (PNP/NPN) Conversion Switch is embedded internally to Pull up / Pull down the resistance of 4.7 kΩ (NPN Setup during shipment)

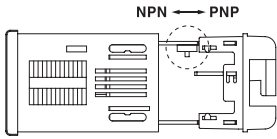

※ Input Logic Setup Status can be verified in Function Setup Mode.

※ Internal Impedance is 4.7 KΩ, and switches over to Pull Up or Pull Down from NPN/PNP Selection. (Refer to Input Connection)

※ To prevent chattering during the use of Contact Input Counter, setup the coefficient speed at 1 or 30 cps in Function Setup Mode.

Timer Mode Setup Method

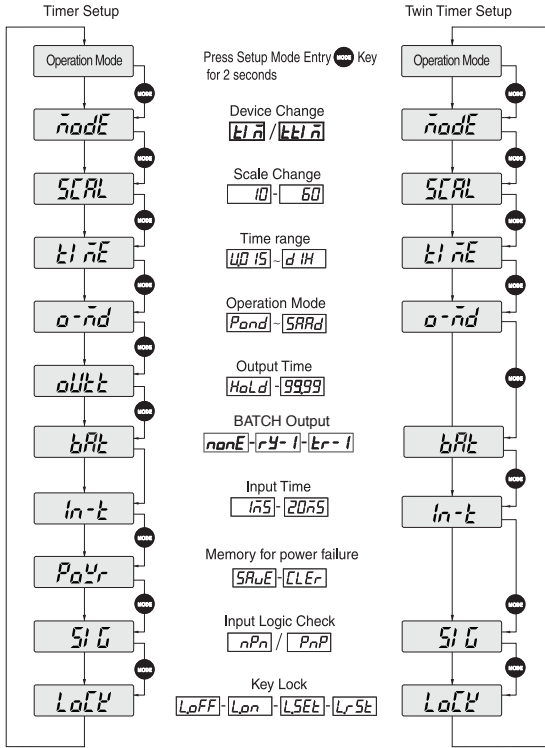

Function Setup Mode (Timer / Twin timer)

Setup Item	Contents	Initial value
Device Change $\bar{n}odE$	$E1\bar{n}$ - $E1n$: 1 Stage setup type $E1\bar{n}$ - $E2\bar{n}$ - $E2n$: 2 Stage setup type	$E1\bar{n}$: Timer $E1n$: Twin Timer
Scale $SCAL$	10 - 60	10 (Decimal) / 60 (Sexagesimal)/system
Time range $E1nE$	$U015$ - $U15$ - $U15$ - $U1n$ - $U1H$ - $d015$ - $d15$ - $d15$ - $d1n$ - $d1H$	$E1n$ 0.01sec ~ 999999(9999)h UP/DOWN selectable
Operation Mode $a\bar{n}d$	In TIM(TIMER) setup $Pond$ - $Sond$ - $Sond$ - $Sofd$ - $Sinb$ - $Sinb$ - $SFLY$ - $SRRd$ In TTIM(TWIN TIMER) setup $Pond$ - $Pofd$ - $Sond$ - $Sofd$ $PrUn$ - $SrUn$ In Total Display only product	Twin timer $E1n$ is not available with 1 Stage output model. Refer to output operation mode char
Output time $outt$	$Hold$ - 9999 s * One short or self-maintenance for OUT2(OUT)	* No display for Total and TWIN TIMER mode
BATCH Output brt	$nonE$ - $rY-1$ - $Er-1$	Set Batch output port (rY : Relay Er : Transistor)
Input time $in-t$	inS - $20nS$	Minimum input time selection 1 ms /20 ms (INHIBIT), (START), RESET
Memory $PaYr$	$SrUe$ - $CLEr$	$SrUe$: Current time and Batch count value are saved when power failure $CLEr$: Remove a data when power failure
Input logic SiG	nPn : NPN Input PnP : PNP Input	Convertible by dip switch It is not available to change setup in power input menu.
Key Lock $LoCk$	$LoFF$ - LoN - $LSSE$ - $LrSt$	$LoFF$: Key Lock LoN : No use for all keys (mode key exception) $LSSE$: BA , >> , << , < No use keys $LrSt$: No use rst keys

- Total(Indicator) type of product does not have setup mode for output time and Batch
- One stage output mode does not have twin timer function

Indicated Time Range

Range Selection		4 digits Time Range		6 digits Time Range	
UP	DOWN	Decimal System	Sexagesimal System	Decimal System	Sexagesimal System
$U015$	$d015$	99.99 s	59.99 s	9999.99 s	59 m 59.99 s
$U15$	$d15$	999.9 s	9 m 59.9 s	99999.9 s	9 h 59 m 59.9 s
$U15$	$d15$	9999 s	59 m 59 s	999999 s	99 h 59 m 59 s
$U1n$	$d1n$	9999 m	99 h 59 m	999999 m	9999 h 59 m
$U1H$	$d1H$	9999 h	99 d 23 h	999999 h	9999 d 23 h

※ s : second m : minute. h : hour d : day

Output Connection

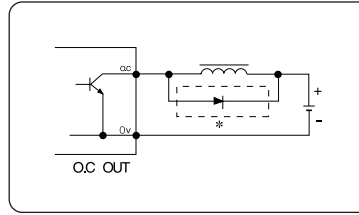

● Example of Non-Contact Output
• Connect surge observer (diode, varistor) on the both ends of the load when using inductive load (relay etc.), and must use with GND since the internal circuit and non-contact output are isolated from one another.
Calculate power load and load to prevent the non-contact output from exceeding the maximum of 30 V 100 mA

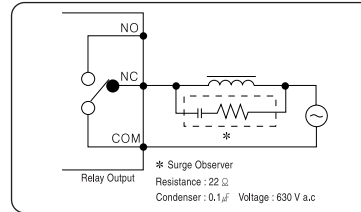

● Example of Contact Output
• Avoid the flow of excessive current since it is 250 V a.c NO 3 A (load resistance) NC 2 A (load resistance), and the connection must correspond to standard connection method.

Timer Operation Mode

TIM(TIMER)Setup	TTIM(TWIN TIMER)Setup	For TOTAL Model
$Pond$ Power RUN / ON delay	$Pond$ Power RUN	$PrUn$ Power RUN
$Sond$ Signal START / ON delay	-ON delay	$SrUn$ Signal RUN
$Sond$ Signal START / ON delay	$Pofd$ Power RUN	
$Sofd$ Signal RUN / OFF delay	-OFF delay	
$Sinb$ Interval / Signal RUN	$Sond$ Signal START	
$Sinb$ Interval / Signal START	-ON delay	
$SFLY$ Flicker / Signal START	$Sofd$ Signal START	
$SFr-r$ Flicker (Counter r Mode)	-OFF delay	
$SFr-p$ Flicker (Counter p Mode)	$PofE$ Power ON RUN	
$SFr-q$ Flicker (Counter q Mode)	-OFF time	
$SRRd$ Signal Addition		

- CP1/INHIBIT function stops the time.
- [S---] is activated when CP2 (START) is 'ON'
- [S ---] is activated when CP2 is maintained 'ON', and resets when 'OFF'.
- [P ---] activates with 'POWER ON'

※ Setup $PaYr$ as $SrUe$ in order to compensate for interruption of electric power during 'POWER OFF' (Indicates the Memorized Value when electric power is inputted again.)

Timer[TIM]Output Operation

- ※ 1 Stage Setup Type Output is OUT.
- ※ INHIBIT (CP1) temporarily stops the time.

■ $Pond$ Power RUN / ON delay

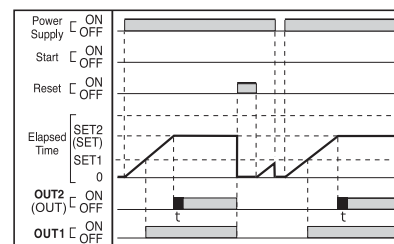

- Runs when 'POWER ON'
- When Reset signal is authorized, process value initializes and runs.

■ **[S_{ond}]** Signal START / ON delay

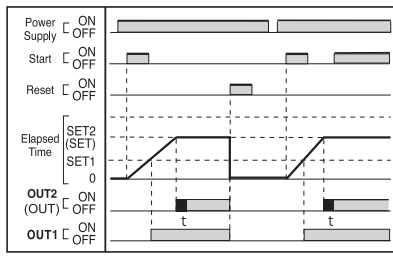

- Run when START (CP2) is 'ON' within the initial setup value
- When setup time exceeds, display value will maintain and output (one short output with *outL* setting).

■ **[S_{onI}]** Signal START / ON delay (Counter F output mode operation)

- RUN when initial setup value of START (CP2) is ON
- When setup time exceeds, display value will increase and put out the output (one short output with *outL* Setting)

■ **[S_{and}]** Signal RUN / ON delay

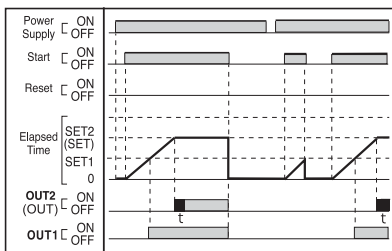

- Run when CP2 (START) is 'ON' within the initial setup value and when 'OFF', it RESET
- When setup time exceeds, it maintains display value and output time

■ **[S_{oFd}]** Signal RUN / OFF delay

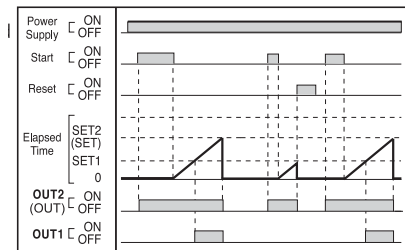

- When START (CP2) is 'ON' then output become 'ON' and time will display initial value.
- Time activates the initial value to run when START (CP2) is 'OFF'.
- The initial value is initialized and output is 'OFF' when the set time elapses.

■ **[S_{Int}]** Interval / Signal RUN

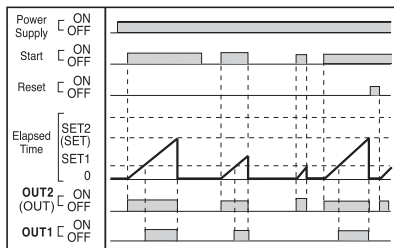

- Runs when START (CP2) is 'ON' and resets when 'OFF'
- Output is 'ON' during the set time, and the initial value is initialized and output is 'OFF' when the set time elapses.

■ **[S_{Int}]** Interval / Signal START

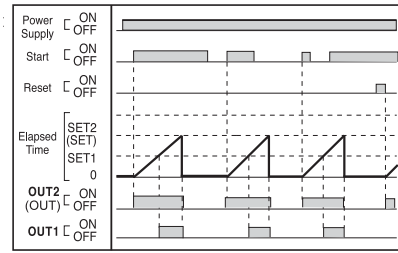

- Runs when START (CP2) is 'ON'.
- Output is 'ON' during the set time, and the indicated value is initialized and output is 'OFF' when the set time elapses.

■ **[S_{FLt}]** Flicker / Signal START

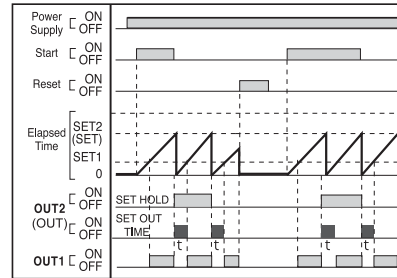

[HOLD] Setup (when output time [OUTT] is set at 0[HOLD])

- Setup Set Time in Run Mode
- Maintains the indication of initial value when Power is 'ON'
- Runs when becomes START (CP2).
- ON/OFF Repetitious Action of control output after reaching the Set Time.
- Initializes and stops when Reset is 'ON'

ONE SHOT TIME Setup (when output time [OUTT] is set at more than 1)

- Setup Set2 Time in Run Mode.
- Maintains the indication of initial value when Power is 'ON'
- Runs when Power is 'ON'
- One Shot Output after reaching the Set Time.
- Initializes and stops when Reset is 'ON'

■ **[S_{F-r}]** **[S_{F-p}]** **[S_{F-q}]** Flicker / Signal START

Same operation as counter output mode **[r]** **[p]** **[q]**

■ **[S_{Add}]** Signal Addition

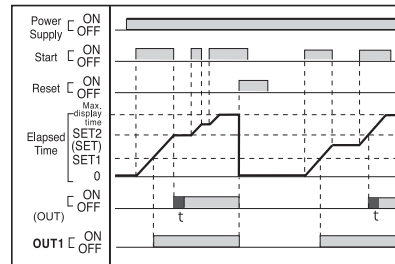

- RUN when START (CP2) maintains ON and it will become HOLD when it is OFF (cumulative Timer Function)
- No **[S_{Add}]** output operation within Down time range

■ **Twin Timer[TTIM]Output Action**

■ **[P_{and}]** Power RUN - ON delay

- Runs when Power is 'ON'
- OFF Output for T1 Time / ON for T2 Time. Repetition
- Initializes and stops when Reset is 'ON'

■ **[P_{oFd}]** Power RUN - ON delay

- Runs when Power is 'ON'
- ON Output for T1 Time / OFF for T2 Time. Repetition
- Initializes and stops when Reset is 'ON'

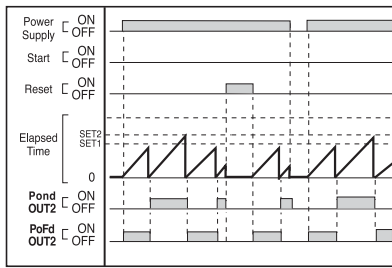

■ **[S_{oFd}]** Signal START - ON delay

- Maintains the indication of initial value when Power is 'ON'
- Run when there is START (CP2) input
- OFF Output for SET1 Time / ON for SET2 Time. Repetition
- Initializes and stops when Reset is 'ON'

■ **[S_{oFd}]** Signal START - ON delay

- Maintains the indication of initial value when Power is 'ON'
- Runs with the input of Start (CP2)
- Output ON for SET1 time/repeat OFF for SET 2 times
- Initializes and stops when Reset is 'ON'

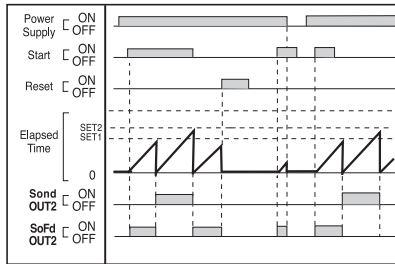

■ **[P_{oFt}]** Power RUN / OFF time

- Individual output control and setup pause time
- RUN when power is ON
- ① Output OUT1 during SET1 time and OUT1 OFF during pause time
- ② Output OUT2 during SET2 time and OUT2 OFF during pause time
- ① and ② operations repeated

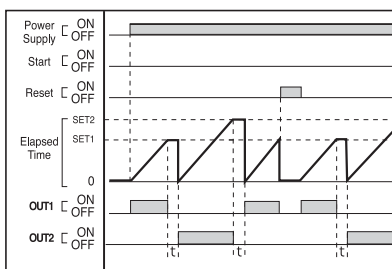

• t: Possible to set up from 0 to 99.99 sec with pause time *outt* setting

■ **Timer Action of Exclusive Indication (GE-T)**

- OFF set is available for up time range of Decimal system. (Press **[BA]** key for 2 second)

■ **[P_{oUn}]** Power RUN

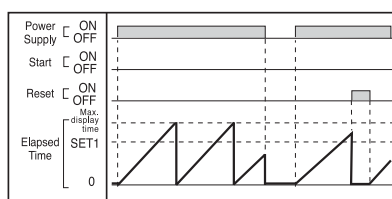

- Runs after initializing the process value upon the authorization of Run Reset Signal when Power is 'ON' Set Time is first to be reduced during Down Mode Setup.

■ **[S_{oUn}]** Signal RUN

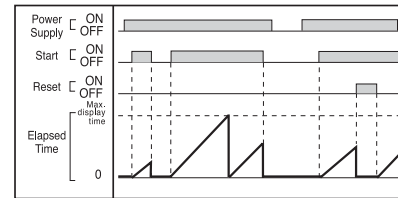

- Runs when START (CP2) is 'ON', and resets when START (CP2) is 'OFF' Set Time is first to be reduced during Down Mode Setup.

Batch Counter

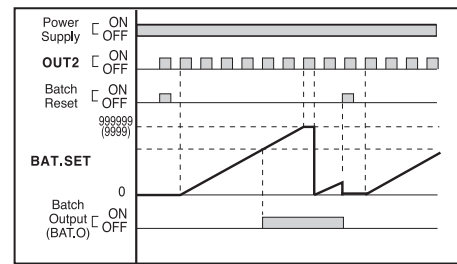

■ **Batch Counting & Output Action**

- Batch counting value continues to increase until Batch Reset is authorized.
- When batch coefficient value exceeds 999999 (4 rows 9999), it initializes to 0 and display
- In case of batch display state (BAT lamp is lighted), press the **[RST]** key on the front section to reset the batch value.
- Even in the batch display state, counter/timer action operates normally.
- Batch coefficient increases at the output of OUT2 (OUT).
- Batch output is outputted as (BAT.O). (BAT.O lamp is lighted)

■ **Instant Output Setup**

- Function switches over to instant output when the batch value is set at 0. (BAT.O lamp is lighted)

■ **Batch Counter setup Method**

1. Press **[BA]** key
Enter to setup state, 6 rows (4rows) FND flickers, set "100" by pressing **[>]** / **[<]** key (When use want to set 100 batch.)
 2. Pressing **[ENT]** key will complete setup. (Pressing **[BA]** key will exit without changing)
 3. Pressing **[BA]** key will return to operation mode. (Left side BAT lamp off)
- ※ Properly operates within BATCH display mode
 ※ Possible to setup BAT only with *err-1, rY-1* BAT setting.

Batch Switchover of 2 Stage Setup Type

