

# Ratchet Relay G4Q

CSM\_G4Q\_DS\_E\_3\_2

## Unique Ratchet Mechanism Assures Positive Alternate Transfer/Switching Operation

- Each contact in the double-pole contact mechanism performs alternate make-brake operation at each pulse input and is thus ideal for alternate operation or transfer/switching operation of a motor.
- Positive operation is assured due to the unique ratchet mechanism.
- Satisfies dielectric strength of 2,000 VAC.
- Low power consumption.  
(AC: approx. 6.4 VA; DC: approx. 3.9 W)

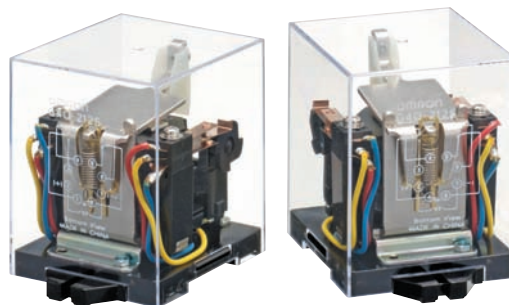

## Ordering Information

When your order, specify the rated voltage.

### Open Models

Item	DPDT	
	Model	Rated voltage
Basic model	G4Q-211A	24 VAC
		50 VAC
		100/(110) VAC
		200/(220) VAC
		12 VDC
		24 VDC
		100 VDC

### Plug-in Models

Item	DPDT	
	Model	Rated voltage
Basic model	G4Q-212S	12 VAC
		24 VAC
		50 VAC
		100/(110) VAC
		200/(220) VAC
		12 VDC
		24 VDC
		100 VDC
200 VDC		

**Note:** When ordering, add the rated coil voltage (listed in *Specifications*) to the model number.

Example: G4Q-211A, 24 VAC

Rated coil voltage

## Model Number Legend

G4Q-□□□□  
1 2 3 4

### 1. Contact Form

2: DPDT

### 2. Contact Type

1: Single

### 3. Enclosure Construction

1: No casing

2: Casing

### 4. Terminal Shape

A: Solder

S: Plug-in

## ■ Accessories (Order Separately)

DIN track/Front-connecting Socket	Back-connecting Socket
Screw terminal	Solder terminal
8PFA1	PL08

## Specifications

### ■ Coil Ratings

Item	Current (mA)		Resistance ( $\Omega$ )	Must operate	Must release	Max. voltage	Power consumption		
	Rated voltage (V)	50 Hz					60 Hz	Initial	Rated
AC	12	614	531	2.24	80 % max.	10 % min.	110 % max.	Approx. 13.5 VA	Approx. 6.4 VA
	24	307	266						
	50	148	128						
	100/ (110)	74	64/73.5						
	200/ (220)	37	32/36.8						

Item	Current (mA)		Resistance ( $\Omega$ )	Must operate	Must release	Max. voltage	Power consumption	
	Rated voltage (V)	50 Hz					60 Hz	Initial
DC	12	320		37.5	5 % min.		Approx. 3.9 W	
	24	155						
	100	39						
	200	19.2						

- Note:**
- The rated current and coil resistance are measured at a coil temperature of 23°C with tolerances of +15%/–20% for AC rated current and  $\pm 15\%$  for DC coil resistance.
  - The AC coil resistance values are for reference only.
  - Performance characteristic data is measured at a coil temperature of 23°C.
  - The maximum voltage is one that is applicable instantaneously to the Relay coil at an ambient temperature of 23°C and not continuously.
  - The AC power consumption is measured at 60 Hz.

### ■ Contact Ratings

Load	Resistive load ( $\cos\phi = 1$ )	Inductive load ( $\cos\phi = 0.4$ ) (L/R = 7 ms)
Contact mechanism	Single	
Contact material	Silver alloy	
Rated load	5 A at 220 VAC, 5 A at 24 VDC	3 A at 220 VAC, 4 A at 24 VDC
Rated carry current	5 A	
Max. switching voltage	250 VAC, 250 VDC	
Max. switching current	5 A	

## ■ Characteristics

<b>Contact resistance (See note 2.)</b>	50 mΩ max.
<b>Operate time (See note 3.)</b>	60 ms max.
<b>Max. operating frequency</b>	Mechanical: 1,200 operations/hr Electrical: 1,200 operations/hr (under rated load)
<b>Insulation resistance (See note 4.)</b>	100 MΩ min. (at 500 VDC)
<b>Dielectric strength</b>	2,000 VAC, 50/60 Hz for 1 min between coil and contact (1,000 VAC, 50/60 Hz for 1 min between contacts of same polarity) (2,000 VAC between contacts of different polarities)
<b>Vibration resistance</b>	Destruction: 10 to 55 to 10 Hz, 0.75 mm single amplitude (1.5 mm double amplitude) Malfunction: 10 to 55 to 10 Hz, 0.5 mm single amplitude (1.0 mm double amplitude)
<b>Shock resistance</b>	Destruction: 500 m/s <sup>2</sup> Malfunction: 100 m/s <sup>2</sup>
<b>Endurance</b>	Mechanical: 5,000,000 operations min. (at operating frequency of 1,200 operations/hr) Electrical: 500,000 operations min. (under rated load and at operating frequency of 1,200 operations/hr) (See note 5.)
<b>Error rate (See note 6.)</b>	1 A at 5 VDC (0.1 A at 5 VDC)
<b>Ambient temperature</b>	Operating: -10°C to 55°C (with no icing or no condensation)
<b>Ambient humidity</b>	Operating: 5% to 85%
<b>Weight</b>	Open model: Approx. 240 g; cased model: Approx. 340 g

**Note:** 1. The data shown above are initial values.

2. The contact resistance was measured with 0.1 A at 5 VDC using the voltage drop method.

3. The operate time was measured with the rated voltage imposed with any contact bounce ignored at an ambient temperature of 23°C.

4. The insulation resistance was measured with a 500-VDC megger applied to the same places as those used for checking the dielectric strength.

5. The electrical endurance was measured at an ambient temperature of 23°C.

6. This value was measured at a switching frequency of 60 operations per minute. The value in parentheses is for the cased model.

## Engineering Data

### Maximum Switching Power

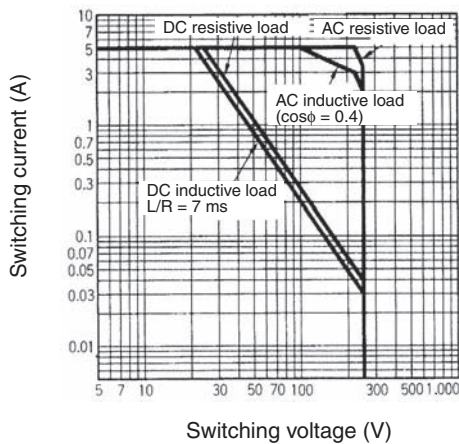

### Electrical Endurance

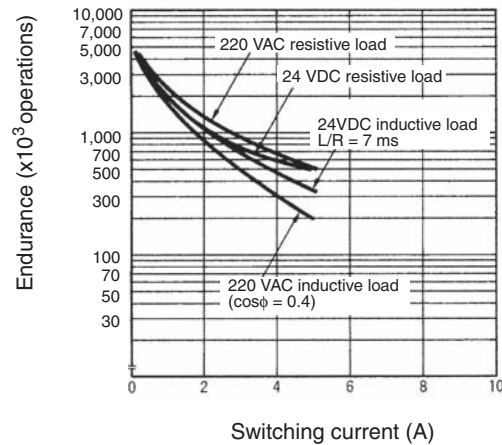

### Ambient Temperature vs. Coil Temperature Rise

100 VAC 50 Hz

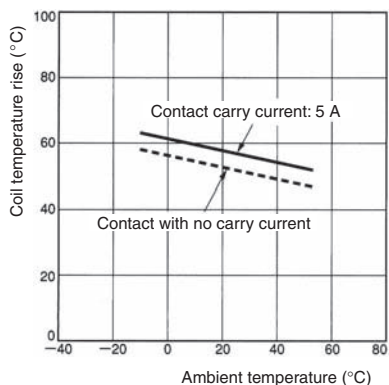

24 VDC

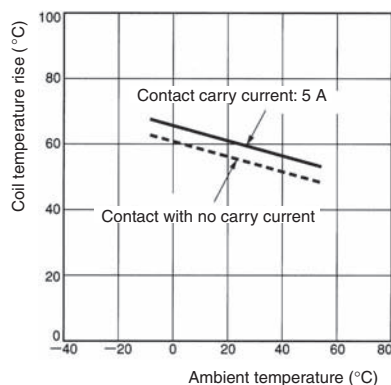

### Malfunctioning Shock

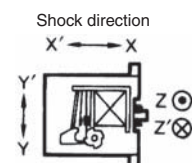
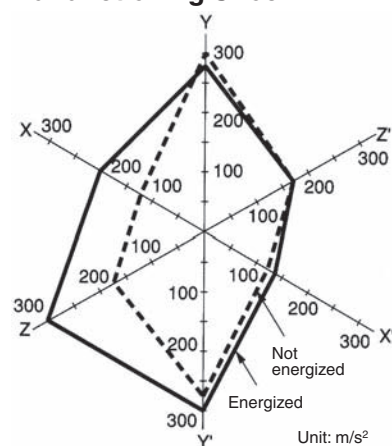

Number of samples: 5  
 Measurement conditions:  
 Impose a shock of 100 m/s<sup>2</sup> in the ±X, ±Y, and ±Z directions three times each with the Relay energized and not energized to check the shock values that cause the Relay to malfunction.

## Operation

### Operation Timing Chart

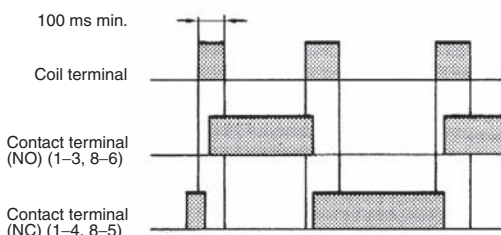

**Note:** When a pulse for application to the coil is used, such a pulse should have a width of 100 ms or more. If a pulse is applied with a width less than the operate time, the cam may fail to rotate fully.

## Dimensions

**Note:** All units are in millimeters unless otherwise indicated.

### Open Model G4Q-211A

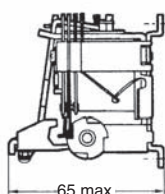
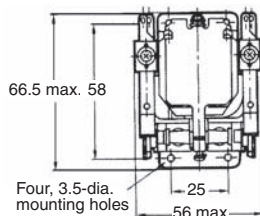
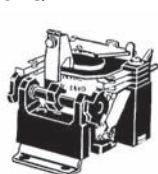

### Terminal Arrangement/ Internal Connections

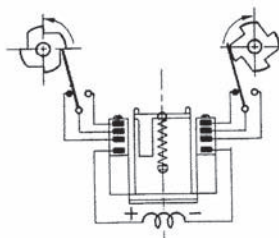

### Mounting Holes

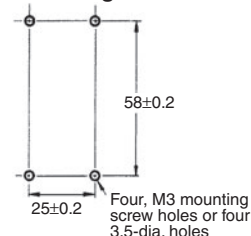

**Plug-in Terminal Model**  
G4Q-212S

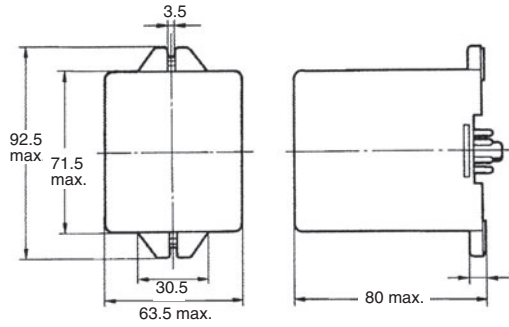
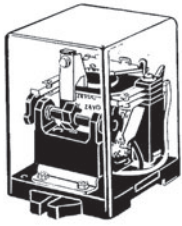

**Terminal Arrangement/  
Internal Connections**  
(Bottom view)

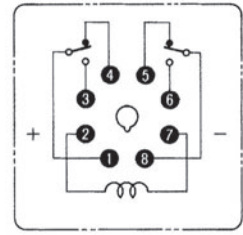

**Relay Mounting Height with Socket**

With Front-connecting  
Socket

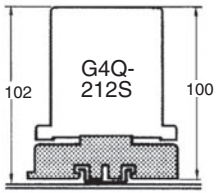

8PFA1

With Back-connecting  
Socket

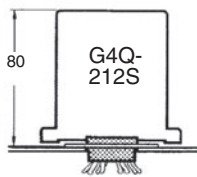

PL08

**Safety Precautions**

Refer to *Safety Precautions for All Relays*.

**■ Surface Mounting Socket**

Be sure to provide a mounting space according to the width of the Relay. The width of the Relay is 63.5 mm and the width of the Socket is 51 mm.

**■ Mounting**

Mount the Relay so that the coil faces upward and the cam faces downwards with the mounting plate secured vertically. Do not change the cam angle.

Make sure that Relay terminals are free of flux or any other foreign substance before soldering the Relay terminals.

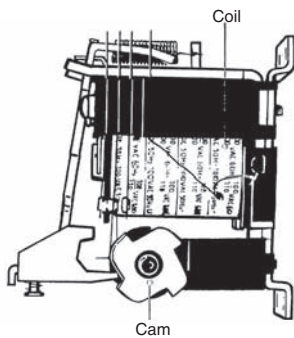

ALL DIMENSIONS SHOWN ARE IN MILLIMETERS.  
To convert millimeters into inches, multiply by 0.03937. To convert grams into ounces, multiply by 0.03527.

In the interest of product improvement, specifications are subject to change without notice.

## Terms and Conditions Agreement

### Read and understand this catalog.

Please read and understand this catalog before purchasing the products. Please consult your OMRON representative if you have any questions or comments.

### Warranties.

(a) Exclusive Warranty. Omron's exclusive warranty is that the Products will be free from defects in materials and workmanship for a period of twelve months from the date of sale by Omron (or such other period expressed in writing by Omron). Omron disclaims all other warranties, express or implied.

(b) Limitations. OMRON MAKES NO WARRANTY OR REPRESENTATION, EXPRESS OR IMPLIED, ABOUT NON-INFRINGEMENT, MERCHANTABILITY OR FITNESS FOR A PARTICULAR PURPOSE OF THE PRODUCTS. BUYER ACKNOWLEDGES THAT IT ALONE HAS DETERMINED THAT THE PRODUCTS WILL SUITABLY MEET THE REQUIREMENTS OF THEIR INTENDED USE.

Omron further disclaims all warranties and responsibility of any type for claims or expenses based on infringement by the Products or otherwise of any intellectual property right. (c) Buyer Remedy. Omron's sole obligation hereunder shall be, at Omron's election, to (i) replace (in the form originally shipped with Buyer responsible for labor charges for removal or replacement thereof) the non-complying Product, (ii) repair the non-complying Product, or (iii) repay or credit Buyer an amount equal to the purchase price of the non-complying Product; provided that in no event shall Omron be responsible for warranty, repair, indemnity or any other claims or expenses regarding the Products unless Omron's analysis confirms that the Products were properly handled, stored, installed and maintained and not subject to contamination, abuse, misuse or inappropriate modification. Return of any Products by Buyer must be approved in writing by Omron before shipment. Omron Companies shall not be liable for the suitability or unsuitability or the results from the use of Products in combination with any electrical or electronic components, circuits, system assemblies or any other materials or substances or environments. Any advice, recommendations or information given orally or in writing, are not to be construed as an amendment or addition to the above warranty.

See <http://www.omron.com/global/> or contact your Omron representative for published information.

### Limitation on Liability; Etc.

OMRON COMPANIES SHALL NOT BE LIABLE FOR SPECIAL, INDIRECT, INCIDENTAL, OR CONSEQUENTIAL DAMAGES, LOSS OF PROFITS OR PRODUCTION OR COMMERCIAL LOSS IN ANY WAY CONNECTED WITH THE PRODUCTS, WHETHER SUCH CLAIM IS BASED IN CONTRACT, WARRANTY, NEGLIGENCE OR STRICT LIABILITY.

Further, in no event shall liability of Omron Companies exceed the individual price of the Product on which liability is asserted.

### Suitability of Use.

Omron Companies shall not be responsible for conformity with any standards, codes or regulations which apply to the combination of the Product in the Buyer's application or use of the Product. At Buyer's request, Omron will provide applicable third party certification documents identifying ratings and limitations of use which apply to the Product. This information by itself is not sufficient for a complete determination of the suitability of the Product in combination with the end product, machine, system, or other application or use. Buyer shall be solely responsible for determining appropriateness of the particular Product with respect to Buyer's application, product or system. Buyer shall take application responsibility in all cases.

NEVER USE THE PRODUCT FOR AN APPLICATION INVOLVING SERIOUS RISK TO LIFE OR PROPERTY OR IN LARGE QUANTITIES WITHOUT ENSURING THAT THE SYSTEM AS A WHOLE HAS BEEN DESIGNED TO ADDRESS THE RISKS, AND THAT THE OMRON PRODUCT(S) IS PROPERLY RATED AND INSTALLED FOR THE INTENDED USE WITHIN THE OVERALL EQUIPMENT OR SYSTEM.

### Programmable Products.

Omron Companies shall not be responsible for the user's programming of a programmable Product, or any consequence thereof.

### Performance Data.

Data presented in Omron Company websites, catalogs and other materials is provided as a guide for the user in determining suitability and does not constitute a warranty. It may represent the result of Omron's test conditions, and the user must correlate it to actual application requirements. Actual performance is subject to the Omron's Warranty and Limitations of Liability.

### Change in Specifications.

Product specifications and accessories may be changed at any time based on improvements and other reasons. It is our practice to change part numbers when published ratings or features are changed, or when significant construction changes are made. However, some specifications of the Product may be changed without any notice. When in doubt, special part numbers may be assigned to fix or establish key specifications for your application. Please consult with your Omron's representative at any time to confirm actual specifications of purchased Product.

### Errors and Omissions.

Information presented by Omron Companies has been checked and is believed to be accurate; however, no responsibility is assumed for clerical, typographical or proofreading errors or omissions.

2015.10

In the interest of product improvement, specifications are subject to change without notice.

**OMRON Corporation**  
Industrial Automation Company

<http://www.ia.omron.com/>

(c)Copyright OMRON Corporation 2015 All Right Reserved.