

Terminal Relay/Terminal SSR G6B-4□□ND/G3S4

CSM_G6B-4_ND_G3S4_DS_E_1_2

Compact Terminal Relays/Terminal SSRs with four outputs

- Easy wiring with separated input/output terminals.
 - LED operation indicator.
 - Mounts either on DIN track or with screws.
 - Special socket used for easy Relay/SSR replacement (except for high-reliability models).
- Terminal Relays
 - Equipped with four G6B Mini-relays that are compact, highly sensitive, and highly resistant to dielectric surges, and that can switch 5 amps of power.
 - Sealed plastic construction used for relays.
 - Built-in diode for absorption of coil surges.
 - UL and CSA certification for standard models (except for high-reliability models).
 - VDE certification for G6B-4BND/47BND/48BND for 12/24 VDC.
 - Terminal SSRs
 - Easy-to-use SSR block that combines four compact G3S SSRs, sockets, and heat sink in one unit.



For the most recent information on models that have been certified for safety standards, refer to your OMRON website.

 Refer to *Safety Precautions for All Relays* and *Safety Precautions* on page 7 and 11.

Terminal Relay types

G6B-4□□ND	Mounted relays: Electromagnetic Relay.....	page 2
G3S4	Mounted relays: Solid State Relay.....	page 8

Common note

Options for the G6B-4CB, G6B-4□□ND, and G3S4	page 12
--	---------

■ Mounted relays

Relays and SSRs cannot be mounted together.

Terminal Relay G6B-4□□ND

Compact Terminal Relay with 4 Independent Outputs

- Equipped with four G6B Mini-relays that are compact, highly sensitive, and highly resistant to dielectric surges, and that can switch 5 amps of power.
- Sealed plastic construction used for relays.
- Easy wiring with separated input/output terminals.
- Special P6B Mounting Socket used to facilitate maintenance (except for high-reliability models).
- UL and CSA certification for standard models (except for high-reliability models).
VDE certification for G6B-4BND/47BND/48BND for 12/24 VDC.
- DIN Track mounting, and screw mounting models are available.
- SSR-equipped G3S4 models are also available.



For the most recent information on models that have been certified for safety standards, refer to your OMRON website.

Refer to Safety Precautions for All Relays .

Model Number Structure

Model Number Legend

G6B-□□□ND
1 2 3

Note: UL508 and CSA requirements met by standard models.

1. Number of Poles

- 4: 4 poles (4PST-NO standard circuit)
- 47: 4 poles (4PST-NO long-life circuit)
- 48: 4 poles (4PST-NO high-reliability circuit)

2. Mounting

- None: DIN Track or screw mounting
- F: Screw mounting

3. Input Terminal

- B: Phillips screw terminals (4 independent points)
- B1: Flat-bladed screw terminals (4 points with same common)
- P: Connector terminals (4 independent points)

Ordering Information

List of Models

When your order, specify the rated voltage.

Classification	Contact form	Mounting method	Terminals	Model	Rated voltage
Equipped with operation indicator and diode to absorb coil surge	4PST (standard)	DIN Track or screw mounting	Phillips screw terminal	G6B-4BND	5 VDC 12 VDC 24 VDC
	4PST (long-life)	DIN Track or screw mounting	Phillips screw terminal	G6B-47BND	5 VDC 12 VDC 24 VDC
	4PST (high reliability)	DIN Track or screw mounting	Phillips screw terminal	G6B-48BND	5 VDC 12 VDC 24 VDC
	4PST (standard)	Screw mounting	Flat-bladed screw terminal	G6B-4FB1ND	5 VDC 12 VDC 24 VDC
	4PST (standard)	Screw mounting	Connector	G6B-4FPND	5 VDC 12 VDC 24 VDC

Note: 1. For replacement relays, use relays with the same voltage specifications as the relays provided with the Terminal when it was purchased. Longer operating life can be achieved by replacing the G6B-4□□ND with the G6B-1174P-FD-US-P6B.

2. Standard models and long-life models are also available without relays mounted to the sockets

3. SSR-equipped G3S4 models are also available. Refer to information on the G3S4 (page 8).

Terminal relay	Socket
G6B-4BND G6B-47BND	P6BF-4BND

Also give the voltage specification.

P6BF-4BND Connection Sockets do not have specific approved standards.

Specifications

■ Ratings

Coil Ratings (per G6B Relay)

Rated voltage	5 VDC	12 VDC	24 VDC
Rated current	35.5 mA (43.4)	19.1 mA	10.7 mA (10.3)
Coil resistance	125 Ω	720 Ω	2,880 Ω
Must operate voltage	80% max. of rated voltage		
Must release voltage	10% min. of rated voltage		
Max. voltage	130% of rated voltage		
Power consumption	Approx. 200 mW		

- Note:**
- Rated current and coil resistance were measured at a coil temperature of 23°C with a tolerance of ±10%.
 - Operating characteristics were measured at a coil temperature of 23°C.
 - The maximum allowable voltage is the maximum value of the allowable voltage range for the relay coil operating power supply. There is no continuous allowance.
 - Diodes to absorb coil surge are equivalent to S5688J (reverse voltage resistance: 600 V; forward current: 1 A).
 - The values in parentheses are for the G6B-4FB1ND and G6B-4FPND.
 - The rated current includes the LED current.

Contact Ratings

Classification	G6B-4BND (standard), G6B-47BND (long-life)		G6B-48BND (high-reliability)	
	Resistive load ($\cos\phi = 1$)	Inductive load ($\cos\phi = 0.4$, L/R = 7 ms)	Resistive load ($\cos\phi = 1$)	Inductive load ($\cos\phi = 0.4$, L/R = 7 ms)
Rated load	5 A at 250 VAC, 5 A at 30 VDC	2 A at 250 VAC, 2 A at 30 VDC	2 A at 250 VAC, 2 A at 30 VDC	0.5 A at 250 VAC, 0.5 A at 30 VDC
Rated carry current	5 A		2 A	
Max. switching voltage	380 VAC, 125 VDC			
Max. switching current	5 A	2 A	2 A	0.5 A
Max. switching power	1,250 VA, 150 W	500 VA, 60 W	500 VA, 60 W	125 VA, 15 W
Error rate (reference value) (see note)	10 mA at 5 VDC		1 mA at 1 VDC	

- Note:** This value fulfills the P reference value of opening/closing at a rate of 120 times per min (ambient operating environment and determination criteria according to JIS C5442).

■ Characteristics

Contact resistance (see note 2)	100 mΩ max.
Operate time	10 ms max. (approx. 3 ms)
Release time	15 ms max. (approx. 4 ms)
Insulation resistance	1,000 MΩ min. (at 500 VDC)
Dielectric strength	2,000 VAC, 50/60 Hz for 1 min between coil and contacts 2,000 VAC, 50/60 Hz for 1 min between contacts of different polarity 1,000 VAC, 50/60 Hz for 1 min between contacts of same polarity 250 VAC, 50/60 Hz for 1 min between coils of different polarity
Vibration resistance	Destruction: 10 to 55 to 10 Hz, 0.75-mm single amplitude (1.5-mm double amplitude) Malfunction: 10 to 55 to 10 Hz, 0.75-mm single amplitude (1.5-mm double amplitude)
Shock resistance	Destruction: 1,000 m/s ² (approx. 100G) Malfunction: 100 m/s ² (approx. 10G)
Endurance	Mechanical: 50,000,000 operations min. (at 18,000 operations/hr) Electrical: 100,000 operations min. (at 1,800 operations/hr, rated load) 500,000 operations min. for long-life at 2 A 100,000 operations min for long-life at 5 A
Ambient temperature	Operating: -25°C to 55°C (with no icing or condensation) Storage: -25°C to 55°C (with no icing or condensation)
Ambient humidity	Operating: 35% to 85%
Weight	Approx. 75 g

- Note:**
- The above values are initial values.
 - Measurement condition: 1 A at 5 VDC

Engineering Data

■ Maximum Switching Power

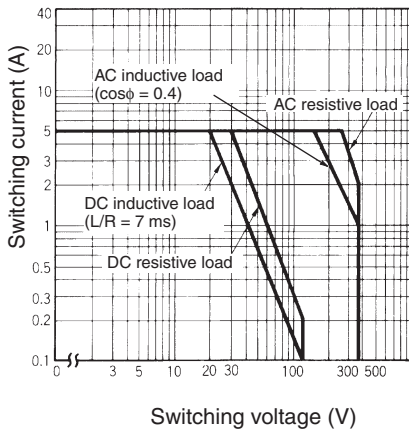

■ Endurance

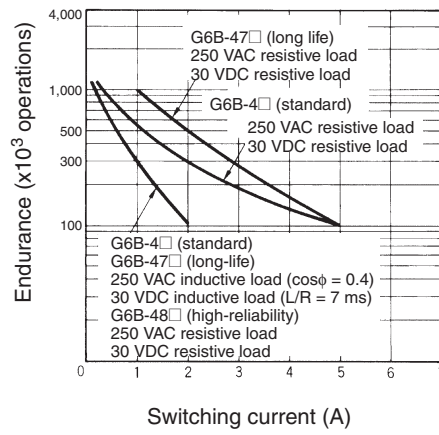

■ Contact Reliability (High-reliability Models)

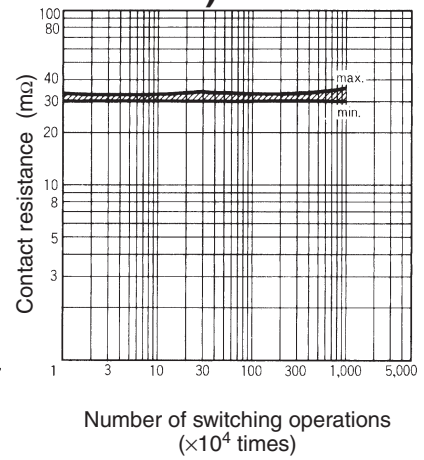

- Note: 1.** Measurement values taken from production line samples have been plotted in graphs to provide this data. Use this data only as a guide. Relays are mass-produced, so allowances must be made for a certain amount of variation in measurement data.
- 2.** The data shown above are values for a single relay.

Dimensions

Note: All units are in millimeters unless otherwise indicated.

Philip Screw Terminals

G6B-4BND

G6B-47BND

G6B-48BND

Note: G6B-4BND is shown in illustration (terminal numbers are incised).

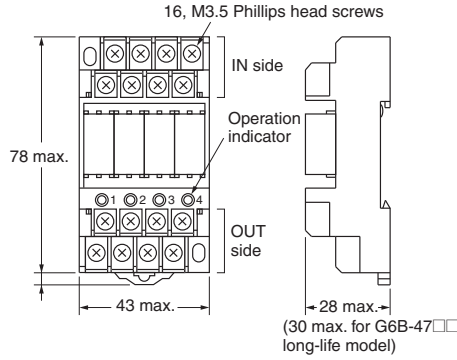
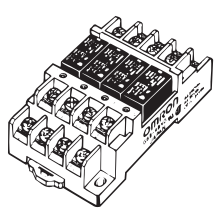

Mounting Holes (Top View)



Terminal Arrangement/ Internal Connections (Top View)

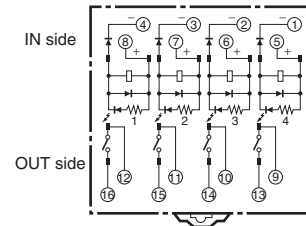

Flat Screw Terminal

G6B-4FB1ND



Mounting Holes (Top View)

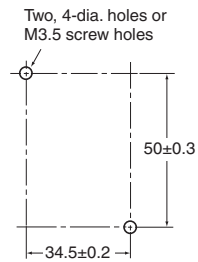

Terminal Arrangement/ Internal Connections (Top View)



Connector Terminal

G6B-4FPND



Mounting Holes (Top View)



Terminal Arrangement/ Internal Connections (Top View)

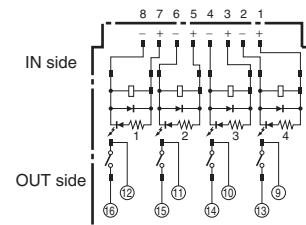

■ Accessories (Order Separately)

Connection Socket (Can be Purchased Individually)

P6BF-4BND
(with operation indicator)



Replacement Relays

Applicable terminal relay	Model	Rated voltage
G6B-4BND G6B-4FB1ND G6B-4FPND	G6B-1114P-FD-US-P6B	5 VDC 12 VDC 24 VDC
G6B-47BND	G6B-1174P-FD-US-P6B	5 VDC 12 VDC 24 VDC

Note: Relays cannot be replaced for G6B-48BND, which is mounted directly to boards.

Relay Mounting Products

Name	Model
Relay Removal Tool	P6B-Y1
Short Bars	G6B-4-SB
Mounting Track	PFP-100N
	PFP-50N
	PFP-100N2
End Plate	PFP-M
Spacer	PFP-S

P6B-Y1 Relay Removal Tool



G6B-4-SB Short Bars

Short Bars are used to wire crossovers for common terminals for coils or contacts.



G6B-4-C Terminal Covers (Two per set)



Relay Removal Tool, Short Bar and Terminal Cover (Order Separately)

Refer to *Options for the G6B-4CB, G6B-4□□ND, and G3S4* on page 12.

Relay Mounting Products (Order Separately)

Refer to *Common Sockets/Products Related DIN Tracks*.

Safety Precautions

Refer to *Safety Precautions for All Relays*.

Wiring

Be sure to turn OFF the power when wiring the Unit and do not touch the charged terminals of the Unit. Otherwise, an electric shock may result.

Do not apply overvoltage to the input terminals. Otherwise, the Unit may malfunction or burn.

Relay Models

Do not connect the Unit to loads exceeding the rated switching power (switching voltage or current). Otherwise, faulty insulation, contact weld, or faulty contact of Relays, or damage to Relays may result, or the Relays may malfunction or burn.

The life of Relays varies with the switching condition. Test the Relays under the actual operating conditions before using the Relays within the permissible switching frequency. The use of deteriorated Relays may result in the faulty insulation of the Relays or cause the Relays to burn.

Do not use the Unit in locations with inflammable gas. Otherwise, a fire or explosion due to the heat of the Relays or sparks from the Relays may result when they are switched.

Correct Use

Mounting

Heat generated by the relays must be considered when gang-mounting. Space must be provided between the relays or other methods must be taken to maintain the relays' ambient temperature at 55 °C or lower.

Replacement of Relays

G6B-4□□ND

Use the P6B-Y1 Removal Tool as shown in the following diagram.



Be sure to turn OFF the power to the Unit before replacing a Relay. Relays must be inserted straight onto the socket connector pins to ensure proper connection.

G6B-48BND models (high reliability) are connected directly to boards to increase reliability and the relays are thus not replaceable. If relay replacement is necessary, use the P6BF-4BND Terminal Sockets together with the G6B-1184P Mini Relays. P6BF-4BND Terminal Sockets are equipped with relay replacement sockets.

Do not mount Relays that are different to one another in voltage.

Relays Mounted

G6B-4□□ND standard: G6B-1114P-FD-US-P6B
 G6B-4□□ND long life: G6B-1174P-FD
 G6B-4□□ND high reliability: G6B-1184P-US
 Replacement is not possible for G6B-48BND.

Mounted Relays

Relays and SSRs cannot be mounted together.

Wiring

Be sure to connect the input terminals with the correct polarity.

Coil Voltage

Be sure not to impose voltage exceeding the permissible voltage on the coil continuously.

Do not use the relays when other inductive loads are connected in parallel with the coil input or when there are surges during power supply because the built-in diodes used to absorb surge may be destroyed.

Do Not Use the Following Circuit



Handling

Do not drop, shock, or vibrate the Unit excessively. Otherwise, damage to the Unit may result or the Unit may malfunction.

Make sure that all the Relays are properly mounted before use.

Screw Tightening Torque

Tighten each terminal screw to a torque described below.

M3 terminal screw: 0.4 to 0.56 N·m.

M3.5 terminal screw: 0.78 to 1.18 N·m.

Tighten each mounting screw to a torque of 0.59 to 0.98 N·m.

Installation Environment

Do not install the Unit in the following locations. Otherwise, damage to the Unit may result or the Unit may malfunction.

Locations with direct sunlight.

Locations with an ambient temperature range not within 0°C to 55°C.

Locations with rapid temperature changes resulting in condensation or locations with relative humidity ranges not within 10% to 90%.

Locations with corrosive or inflammable gas.

Locations with excessive dust, salinity, or metal powder.

Locations with vibration or shock affecting the Unit.

Locations with water, oil, or chemical sprayed on the Unit.

Disassembly, Repair, and Modification

Do not disassemble, repair, or modify the Unit. Otherwise, an electric shock may result or the Unit may malfunction.

ALL DIMENSIONS SHOWN ARE IN MILLIMETERS.

To convert millimeters into inches, multiply by 0.03937. To convert grams into ounces, multiply by 0.03527.

In the interest of product improvement, specifications are subject to change without notice.

Terminal SSR G3S4

Compact Terminal SSR with 4 Outputs

- Easy-to-use SSR block that combines four compact G3S SSRs, sockets, and heat sink in one unit.
- Easy wiring with separate I/O terminal construction.
- LED operation indicator.
- Special socket used for easy Relay replacement.
- Mounts either on DIN track or with screws.
- Electromagnetic relay-equipped G6B-4□□ND models are also available.



 Refer to *Safety Precautions for All Relays* .

Ordering Information

List of Models

When your order, specify the rated voltage.

Contact configuration	Heat sink	Built-in SSRs	Zero cross function	Applicable output load	Model	Rated voltage
Four SPST-NO relays	Yes	G3S-201PL-PD	No	1 A at 75 to 264 VAC (See note 1.)	G3S4-A	5 VDC
						12 VDC
				24 VDC		
	No			0.6 A at 75 to 264 VAC (See note 1.)	G3S4-A1	5 VDC
					12 VDC	
		24 VDC				
	Yes	G3SD-Z01P-PD		1 A at 3 to 26 VDC (See note 2.)	G3S4-D	5 VDC
						12 VDC
	24 VDC					
No	0.6 A at 3 to 26 VDC (See note 2.)		G3S4-D1	5 VDC		
			12 VDC			
	24 VDC					

- Note:** 1. Electromagnetic relay-equipped G6B-4□□ND models are also available. Refer information on *G6B-4□□ND* (page 2).
 2. Given as "250 VAC" on the G3S4.
 3. Given as "24 VDC" on the G3S4.

Accessories (Order Separately)

Connection Sockets (Can be Purchased Individually)

Model	Rated voltage
P6BF-4BND	5 VDC
	12 VDC
	24 VDC
	24 VDC

Heat Sinks (Can be Purchased Individually)

Model
Y92B-S10

Replacement Relays

Model	Rated voltage
G3S-201PL-PD	5 VDC
	12 VDC
	24 VDC
G3SD-Z01P-PD	5 VDC
	12 VDC
	24 VDC

Relay Removal Tool, Short Bar and Terminal Cover (Order Separately)

Refer to *Options for the G6B-4CB, G6B-4□□ND, and G3S4* on page 12.

Relay Mounting Products (Order Separately)

Refer to *Common Sockets/Products Related DIN Tracks*.

Specifications

■ Ratings

Input (per G3S Relay)

Rated voltage	Operating voltage	Must operate level	Must release voltage level	Input impedance		Rated current		
				G3S4-A, G3S4-A1	G3S4-D, G3S4-D1	G3S4-A, G3S4-A1	G3S4-D, G3S4-D1	
DC	5 V	4 to 6 VDC	4 VDC max.	1 VDC min.	440 Ω±20%	550 Ω±20%	19.2 mA±20%	15.8 mA±20%
	12 V	9.6 to 14.4 VDC	9.6 VDC max.		1 kΩ±20%	1.2 kΩ±20%	15.8 mA±20%	12.5 mA±20%
	24 V	19.2 to 28.8 VDC	19.2 VDC max.		2.1 kΩ±20%	2.3 kΩ±20%	15.7 mA±20%	13.2 mA±20%

Note: The rated current includes the terminal's LED current.

Output (per G3S Relay)

Model	Applicable load	Load voltage	Load current	Inrush current resistance
G3S4-A	75 to 264 VAC		0.1 to 1 A	15 A (60 Hz, 1 cycle)
G3S4-A1			0.1 to 0.6 A	
G3S4-D	3 to 26 VDC		0.01 to 1 A	3 A (10 ms)
G3S4-D1			0.01 to 0.6 A	

■ Characteristics

Item	Model	G3S4-A, G3S4-A1	G3S4-D, G3S4-D1
Must operate time		1 ms max.	
Release time		0.5 × load power cycle + 1 ms max.	1 ms max.
Output ON voltage drop		1.6 V max. (RMS)	1.5 V max.
Leakage current		2 mA max.	0.1 mA max. (at 26 VDC)
Insulation resistance		100 MΩ min. (at 500 VDC)	
Dielectric strength		2,000 VAC, 50/60 Hz for 1 min	
Vibration resistance		10 to 55 to 10 Hz, 0.75-mm single amplitude (1.5-mm double amplitude)	
Shock resistance		1,000 m/s ²	
Storage temperature		-30 to 100°C (with no icing)	
Ambient operating temperature		-30 to 80°C (with no icing)	
Ambient operating humidity		45% to 85%	
Weight		Approx. 95 g (-A model)	Approx. 95 g (-D model)

Engineering Data

■ Reference Data

(per G3S Relay)

Load Current vs. Ambient Rated Temperature



Inrush Current Resistance

Non-repetitive (Keep the inrush current to half the rated value if inrush current occurs repetitively.)

G3S4-A, G3S4-A1



G3S4-D, G3S4-D1



Note: Measurement values taken from production line samples have been plotted in graphs to provide this data. Use this data only as a guide. Relays are mass-produced, so allowances must be made for a certain amount of variation in measurement data.

Dimensions

Note: All units are in millimeters unless otherwise indicated.

Relays

With Heat Sinks

G3S4-A
G3S4-D



Mounting Holes (Top View)



Without Heat Sinks

G3S4-A1
G3S4-D1



Terminal Arrangement/Internal Connections (Top View)



Accessories (Order Separately)

Connection Socket (Can be Purchased Individually)

P6BF-4BND
(with operation indicator)



Note: Make sure that the polarity of the input terminal is correct. The polarity given inside parentheses () is for G3S4-D and G3S4-D1 Relays. There is no indication of polarity when Connection Sockets are used alone.

Heat Sinks (Can be Purchased Individually)

Y92B-S10



Mounting Brackets



Replacement Relays

G3S-201PL-PD
G3SD-201P-PD

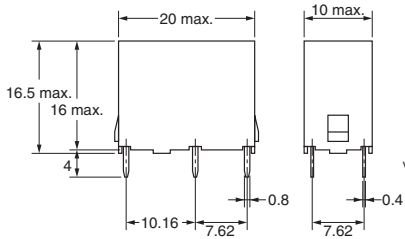

Terminal Arrangement/Connections (Bottom View)



Note: 1. The polarity given inside parentheses () is for DC loads.
2. The load can be connected to either the positive or negative SSR output terminal.

Relay Removal Tool and Short Bar (Order Separately)

Refer to *Options for the G6B-4CB, G6B-4BND, and G3S4* on page 12.

Relay Mounting Products (Order Separately)

Refer to *Common Sockets/Products Related DIN Tracks*.

Safety Precautions

Refer to *Safety Precautions for All Relays*.

■ Precautions for Correct Use

- The four SSRs are mounted individually. Use standard SSR connection methods.
- There is almost no differences based on the mounting direction. Mount the Terminal SSR with the best air flow.
- Apply a silicon grease for heat radiation (e.g., YG6260 or G746 from Shin-Etsu Chemical Co. Ltd.) between the heat sink and the SSR if the heat sink is removed during maintenance of the G3S4-A or G3S4-D Terminal SSR (with external heat sinks) or if an external heat sink that was purchased separately is mounted.
- The load voltage cannot be increased by connecting the G3S4 load terminals in serial. This is because there is a small difference in the SSR operating time
- The load current cannot be increased by connecting the G3S4 load terminal in parallel. This is because there is a small difference in the SSR operating time.
- The P6BF-4BND Connection Socket has an operation indicator and is available in 5-VDC, 12-VDC, and 24-VDC models.
- Use the P6B-Y1 Relay Removal Tool to remove SSRs.

Mounted Relays

Relays and SSRs cannot be mounted together.

Options for the G6B-4CB, G6B-4□□ND, and G3S4

Relay Removal Tool

P6B-Y1



Ordering Information

Applicable Terminal Relays	Model
G6B-4CB G6B-4□□ND G3S4	P6B-Y1

Short Bar

G6B-4-SB

(A Short Bar is used to wire crossovers for common terminals for coils or contacts.)



Ordering Information

Applicable Terminal Relays	Model
G6B-4CB G6B-4□□ND G3S4	G6B-4-SB

Terminal Cover (Two per Set)

G6B-4-C



Ordering Information

Applicable Terminal Relays	Model
G6B-4BND G6B-47BND G6B-48BND G3S4-A1 G3S4-D1	G6B-4-C

Connection Socket (Can be Purchased Individually)

P6BF-4BND (with operation indicator)



Ordering Information

Applicable Terminal Relays	Model	Rated voltage
G6B-4BND G6B-47BND G3S4	P6BF-4BND	5 VDC
		12 VDC
		24 VDC

Also give the voltage specification.

P6BF-4BND Connection Sockets do not have specific approved standards.

Terms and Conditions Agreement

Read and understand this catalog.

Please read and understand this catalog before purchasing the products. Please consult your OMRON representative if you have any questions or comments.

Warranties.

(a) Exclusive Warranty. Omron's exclusive warranty is that the Products will be free from defects in materials and workmanship for a period of twelve months from the date of sale by Omron (or such other period expressed in writing by Omron). Omron disclaims all other warranties, express or implied.

(b) Limitations. OMRON MAKES NO WARRANTY OR REPRESENTATION, EXPRESS OR IMPLIED, ABOUT NON-INFRINGEMENT, MERCHANTABILITY OR FITNESS FOR A PARTICULAR PURPOSE OF THE PRODUCTS. BUYER ACKNOWLEDGES THAT IT ALONE HAS DETERMINED THAT THE PRODUCTS WILL SUITABLY MEET THE REQUIREMENTS OF THEIR INTENDED USE.

Omron further disclaims all warranties and responsibility of any type for claims or expenses based on infringement by the Products or otherwise of any intellectual property right. (c) Buyer Remedy. Omron's sole obligation hereunder shall be, at Omron's election, to (i) replace (in the form originally shipped with Buyer responsible for labor charges for removal or replacement thereof) the non-complying Product, (ii) repair the non-complying Product, or (iii) repay or credit Buyer an amount equal to the purchase price of the non-complying Product; provided that in no event shall Omron be responsible for warranty, repair, indemnity or any other claims or expenses regarding the Products unless Omron's analysis confirms that the Products were properly handled, stored, installed and maintained and not subject to contamination, abuse, misuse or inappropriate modification. Return of any Products by Buyer must be approved in writing by Omron before shipment. Omron Companies shall not be liable for the suitability or unsuitability or the results from the use of Products in combination with any electrical or electronic components, circuits, system assemblies or any other materials or substances or environments. Any advice, recommendations or information given orally or in writing, are not to be construed as an amendment or addition to the above warranty.

See <http://www.omron.com/global/> or contact your Omron representative for published information.

Limitation on Liability: Etc.

OMRON COMPANIES SHALL NOT BE LIABLE FOR SPECIAL, INDIRECT, INCIDENTAL, OR CONSEQUENTIAL DAMAGES, LOSS OF PROFITS OR PRODUCTION OR COMMERCIAL LOSS IN ANY WAY CONNECTED WITH THE PRODUCTS, WHETHER SUCH CLAIM IS BASED IN CONTRACT, WARRANTY, NEGLIGENCE OR STRICT LIABILITY.

Further, in no event shall liability of Omron Companies exceed the individual price of the Product on which liability is asserted.

Suitability of Use.

Omron Companies shall not be responsible for conformity with any standards, codes or regulations which apply to the combination of the Product in the Buyer's application or use of the Product. At Buyer's request, Omron will provide applicable third party certification documents identifying ratings and limitations of use which apply to the Product. This information by itself is not sufficient for a complete determination of the suitability of the Product in combination with the end product, machine, system, or other application or use. Buyer shall be solely responsible for determining appropriateness of the particular Product with respect to Buyer's application, product or system. Buyer shall take application responsibility in all cases.

NEVER USE THE PRODUCT FOR AN APPLICATION INVOLVING SERIOUS RISK TO LIFE OR PROPERTY OR IN LARGE QUANTITIES WITHOUT ENSURING THAT THE SYSTEM AS A WHOLE HAS BEEN DESIGNED TO ADDRESS THE RISKS, AND THAT THE OMRON PRODUCT(S) IS PROPERLY RATED AND INSTALLED FOR THE INTENDED USE WITHIN THE OVERALL EQUIPMENT OR SYSTEM.

Programmable Products.

Omron Companies shall not be responsible for the user's programming of a programmable Product, or any consequence thereof.

Performance Data.

Data presented in Omron Company websites, catalogs and other materials is provided as a guide for the user in determining suitability and does not constitute a warranty. It may represent the result of Omron's test conditions, and the user must correlate it to actual application requirements. Actual performance is subject to the Omron's Warranty and Limitations of Liability.

Change in Specifications.

Product specifications and accessories may be changed at any time based on improvements and other reasons. It is our practice to change part numbers when published ratings or features are changed, or when significant construction changes are made. However, some specifications of the Product may be changed without any notice. When in doubt, special part numbers may be assigned to fix or establish key specifications for your application. Please consult with your Omron's representative at any time to confirm actual specifications of purchased Product.

Errors and Omissions.

Information presented by Omron Companies has been checked and is believed to be accurate; however, no responsibility is assumed for clerical, typographical or proofreading errors or omissions.

2020.5

In the interest of product improvement, specifications are subject to change without notice.

OMRON Corporation
Industrial Automation Company

<http://www.ia.omron.com/>

(c)Copyright OMRON Corporation 2020 All Right Reserved.