

BUSBAR SUPPORT EL TYPE

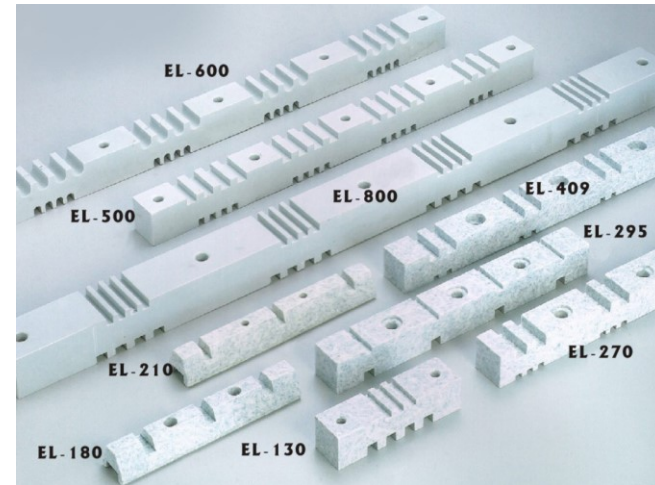

- Operating temperature: $-40\text{ }^{\circ}\text{C} \dots +140\text{ }^{\circ}\text{C}$
- Material: BMC (Bough moulding compound)
- Special color, size, material and insert upon request with reasonable quantity
- Insulator is the special part to fix,install and insulat on communication, electric power, lightning protection, machinery, medical, wind energy, frequency conversion equipment,new energy vehicles (integrated chassis cabinets, locker, etc.) to provide meet the fixed support, installation and insulation isolation effect of special parts, it is also known as insulators, insulation column .

*Busbar support chart

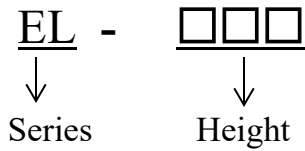
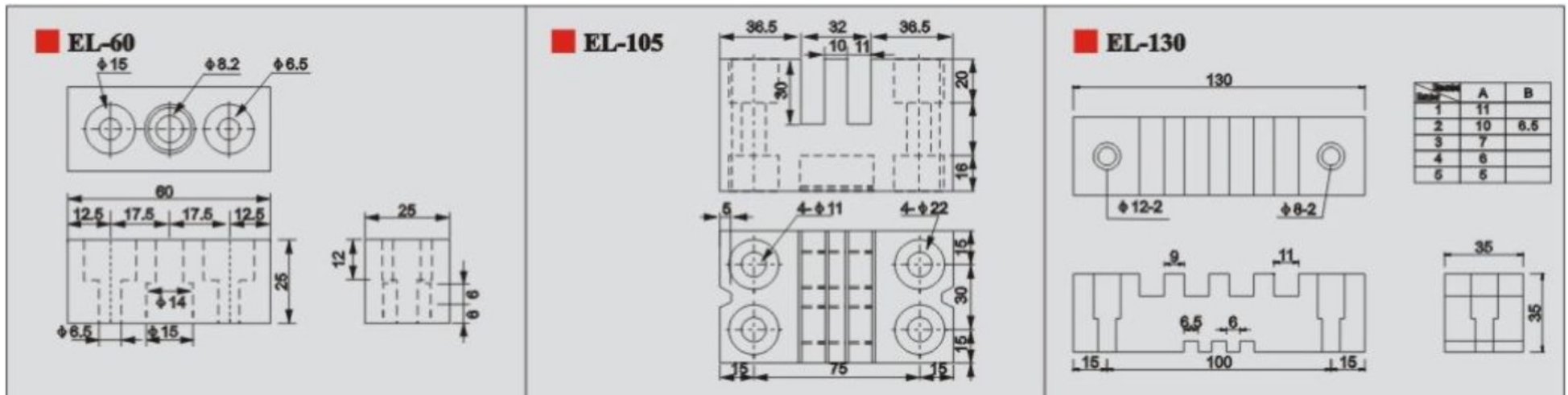

EL-155

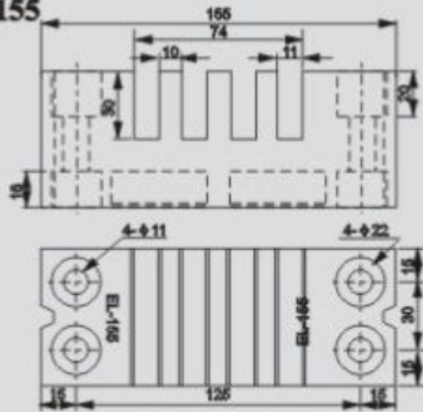

EL-170

Dimension Number	A
1	6
2	7



EL-180

No.	SIZE	A
1	7	
2	11	

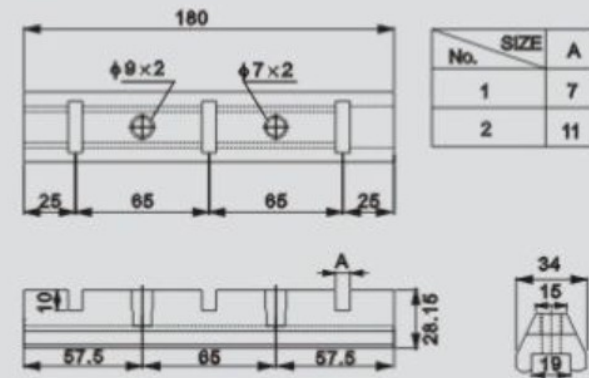

EL-210

Dimension Number	A	B	C	D	W
2	28	18	10	7	7.5
3	28	18	10	7	11.5
4	28	18	10	7	10
12	31	21	13	10	7.5
13	31	21	13	10	11.5
14	31	21	13	10	10

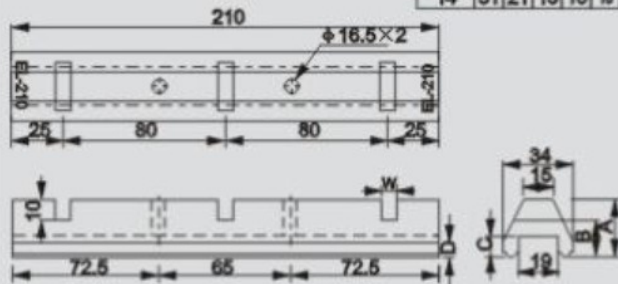

EL-270

Dimension Number	A	D
1	12	7
2	12	0
3	11	6
4	10	5

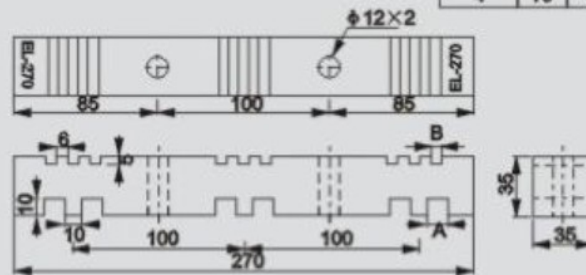

EL-295

Dimension Number	A	B
1	11	-
2	22	-
3	5	-
4	6.3	-
5	11	6.3

