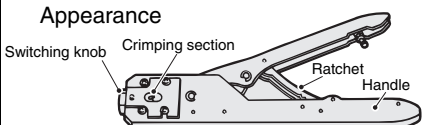

Accessories (Order Separately)

Ordering Information

Connectors and Connector Hold-down Clips

Applicable Sensor models EE-SX67□ (A, P, R), EE-SX47□, EE-SY67□, EE-SPY31□/41□, EE-SPX303N/403N, EE-SPW311/411			
Type	Cable length	Model	Remarks
Connector		EE-1001	
		EE-1001-1	L terminal and positive (+) terminal are already short-circuited.
		EE-1009 *1	
Connector with Cable	1 m	EE-1006 1M	
		EE-1010 1M *1	
		EE-1006 2M	4 conductors
	2 m	EE-1006D	3 conductors
		EE-1006L	2 conductors
		EE-1010 2M *1	
Connector with Robot Cable	1 m	EE-1010-R 1M *1	
	2 m	EE-1010-R 2M*1	
NPN/PNP Conversion Connector	0.46 m (total length)	EE-2002	
Connector Hold-down Clip		EE-1006A	For EE-1006, EE-SX670□, 470, EE-SY671, and 672 only.
Connector Parts *2	Case (housing)	EE-1006H	100 per carton
	Dispersion Pins	EE-1006C	500 per carton
	Special Crimping Tool	EE-1006T	Appearance 

*1. EE-1009- or EE-1010-series Connectors have a builtin locking mechanism to prevent cable disconnection when only the cable is pulled. To remove the Connector from the Sensor, grip the top and bottom of the Connector firmly and push into the Sensor once before pulling out. The locking mechanism prevents the Connector from being removed by pulling on the cable only and enables removal only when the Connector (housing) is pulled.

*2. The case (housing) and dispersion pins (for hand-crimping) for EE-1006 Connectors can be ordered separately. Use the EE-1006T Special Crimping Tool to prepare the Connector.

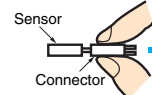





Applicable Sensor models EE-SX95□-C1J-R			
Item	Cable length	Model	Remarks
Connector with Robot Cable	2 m	EE-1016-R 2M	



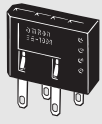

Applicable Sensor models EE-SX97□-C1, EE-SX97□P-C1			
Item	Cable length	Model	Remarks
Connector with Cable	1 m	EE-1017 1M	
	3 m	EE-1017 3M	
Connector with Robot Cable	1 m	EE-1017-R 1M	
	3 m	EE-1017-R 3M	

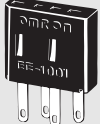
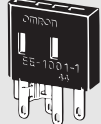
Applicable Sensor models EE-SPX74□/84□			
Item	Cable length	Model	Remarks
Connector with Cable	1 m	EE-1013 1M	

Applicable Sensor models EE-SPX301/401, EE-SPY30□/40□, EE-SPZ301-A/401-A			
Item	Cable length	Model	Remarks
Connector		EE-1002	
Connector with Cable	1 m	EE-1003	
NPN/PNP Conversion Connector	0.46 m (total length)	EE-2001	
Connector Hold-down Clip		EE-1003A	For EE-1003 only.

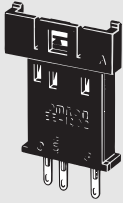
Ratings and Specifications

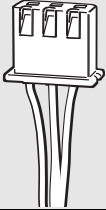
Product	Connector *1 *4	Connector with Cable *1	Connector with Robot Cable *1	Connector *4	Connector (short-circuited between positive (+) and L terminals) *2 *4	Connector with Cable
Model	EE-1009	EE-1010	EE-1010-R	EE-1001	EE-1001-1	EE-1006
Appearance						
Item						
Contact resistance	20 mΩ max. (at 20 mV max., 100 mA max.)			15 mΩ max. (at 100 VDC max.)		10 mΩ max. (100 VDC max.)
Insertion/removal durability *3	50 times min.			---		
Insertion strength	No. of poles × 6 N max.			68.6 N max.		50 N max.
Surplus strength (housing holding strength)	No. of poles × 0.4 N max.			---		20 N max.
Standard cable length	---	1 m, 2 m		---	---	1 m, 2 m
Lock strength *3	No. of poles × 29 N min.			---		
Ambient humidity	-10 to +60°C			-10 to +75°C		-10 to 60°C
Material	Housing	Polybutylene phthalate (PBT)				
	Contact	Phosphor bronze				
Applicable Photomicrosensors	EE-SX67□ (A,P,R) (Connector Models only), EE-SX47□, EE-SY67□, EE-SPY31□/41□, EE-SPX303N/403N, EE-SPW311/411					

Product	Connector *4	Connector with Cable	Connector with Cable	Connector with Robot Cable	Connector with Cable	Connector with Robot Cable
Model	EE-1002	EE-1003	EE-1013	EE-1016-R	EE-1017	EE-1017-R
Appearance						
Item						
Contact resistance	10 mΩ max. (at 10 mADC and 1 ADC)	20 mΩ max. (at minute current of 1 kHz and 500 VDC)		25 mΩ max. (at 10 mA DC and 20 mV max.)		
Insertion strength	20 N max.	23.5 N max.	40 N max.	20 N max.		
Surplus strength (housing holding strength)	15 N min. (initial) 10 N min. (ten times)	3.5 N min.	10 N min.	15 N min.	1.5 N min.	
Cable length	---	1 m		2 m	1 m, 3 m	
Ambient humidity	-10 to +75°C	-10 to +60°C	-10 to +55°C	-25 to +85°C	-10 to +60°C	
Material	Housing	Nylon				
	Contact	Phosphor bronze				
Applicable Photomicrosensors	EE-SPX301/401, EE-SPY30□/40□, EE-SPZ301-A/401-A		EE-SPX74□/84□	EE-SX95□-C1J-R	EE-SX97□C1, EE-SX97□P-C1	

*1. The Connector has a built-in locking mechanism. To remove the Connector from the Sensor, grip the top and bottom of the Connector housing, as shown in the following diagram, and then pull out the Connector.

*2. EE-SX67□ and EE-SY67□ are the best used in the light-ON state.

*3. The insertion/removal durability and lock strength apply only to the lock mechanism.

They do not apply to the EE-1001, EE-1001-1, and EE-1006, which do not have lock mechanisms.

*4. Do not store the type EE-1009, EE-1001, EE-1001-1 and EE-1002 under the following conditions since their terminals may discolor.

(1) In the place exposed to the direct sunlight, the high temperature or high humidity.

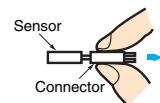

(Unit: mm)

Dimensions

Tolerance class IT16 applies to dimensions in this datasheet unless otherwise specified.

Photomicrosensor Connectors and Connector Hold-down Clips

Connector

EE-1001

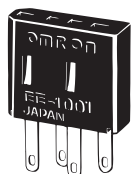

Terminal Arrangement

(1)	+
(2)	L
(3)	OUT
(4)	-

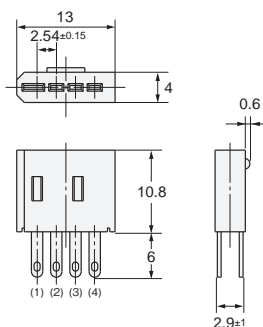

Connector (short-circuited between positive (+) and L terminals)

EE-1001-1

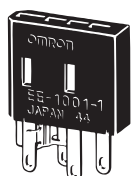

Terminal Arrangement

(1)	+
(2)	L
(3)	OUT
(4)	-

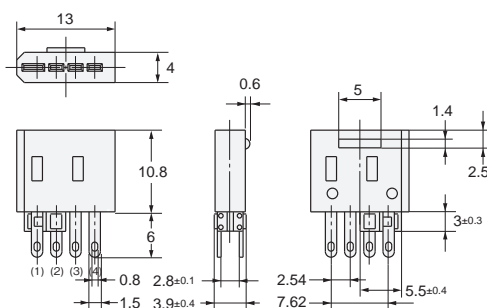

Connector with Cable

EE-1006 2M (EE-1006 1M)

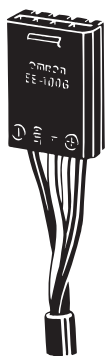

Terminal Arrangement

(1)	+	Brown
(2)	L	Pink
(3)	OUT	Black
(4)	-	Blue

Cable:
4-dia. 4-conductor vinyl-insulated round cable
(Conductor cross section: 0.2 mm², Insulator diameter: 1.1 mm).

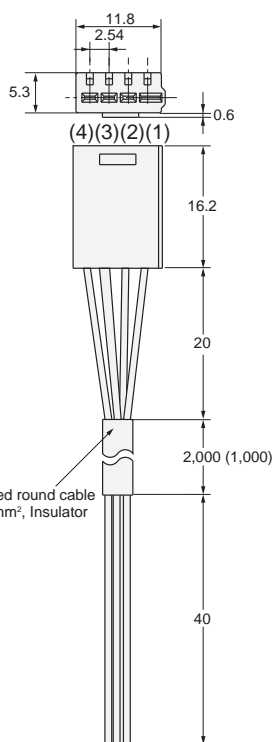

Connector Hold-down Clip

EE-1006A

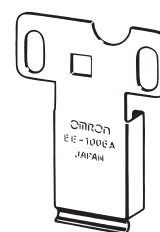

(Can be used only with EE-1006 Connectors for the Photomicrosensors listed below.)

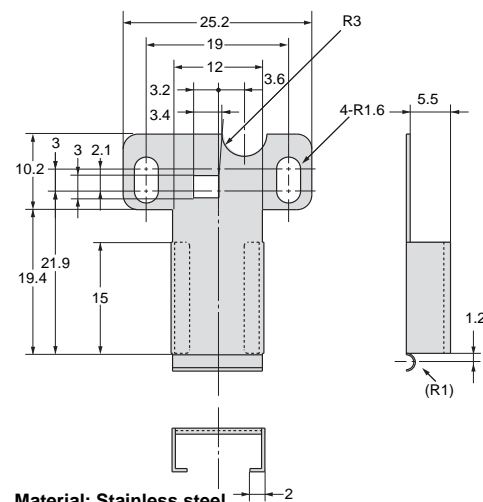

Material: Stainless steel

Applicable Photomicrosensors EE-SX67□ (A,P,R) (Connector Models only), EE-SX47□, EE-SY67□, EE-SPY31□/41□, EE-SPX303N/403N, EE-SPW311/411

For EE-SX670□, 470□, EE-SY671, and 672 only.

Photomicrosensor Connectors

Connectors

EE-1009

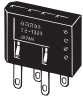

Terminal Arrangement

(1)	⊕
(2)	L
(3)	OUT
(4)	⊖

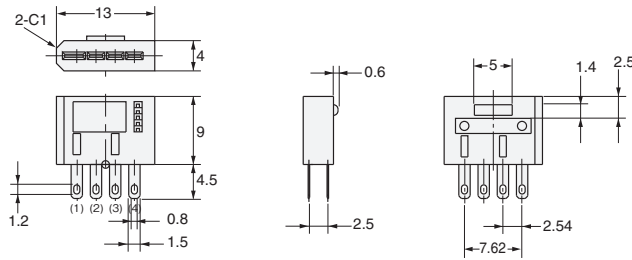

Connector with Cable

EE-1010 2M (EE-1010 1M)

Connector with Robot Cable

EE-1010-R 2M (EE-1010-R 1M)

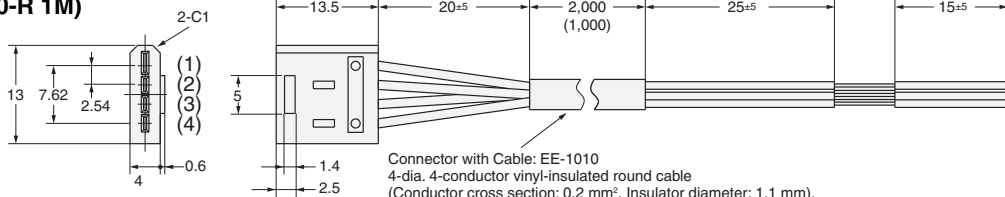

Connector with Cable: EE-1010
4-dia. 4-conductor vinyl-insulated round cable
(Conductor cross section: 0.2 mm², Insulator diameter: 1.1 mm).
Connector with Robot Cable: EE-1010-R
4-dia. 4-conductor robot instrumentation cable
(Conductor cross section: 0.2 mm², Insulator diameter: 1.1 mm).

Terminal Arrangement

(1)	⊕	Brown
(2)	L	Pink
(3)	OUT	Black
(4)	⊖	Blue

Applicable Photomicrosensors	EE-SX67□ (A,P,R) (Connector Models only), EE-SX47□, EE-SY67□, EE-SPY31□/41□
	EE-SPX303N/403N, EE-SPW311/411

Connector with Robot Cable

EE-1016-R

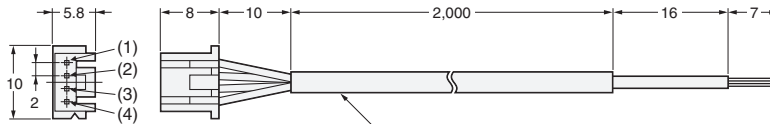

2.8-dia. 4-conductor robot instrumentation cable
(Conductor cross section: 0.15 mm², Insulator diameter: 0.8 mm); Standard length: 2 m

Terminal Arrangement

(1)	⊕	Brown
(2)	OUT2	White
(3)	⊖	Blue
(4)	OUT1	Black

Applicable Photomicrosensors	EE-SX95□-C1J-R
------------------------------	----------------

Photomicrosensor Connectors and Connector Hold-down Clips

Connector

EE-1002

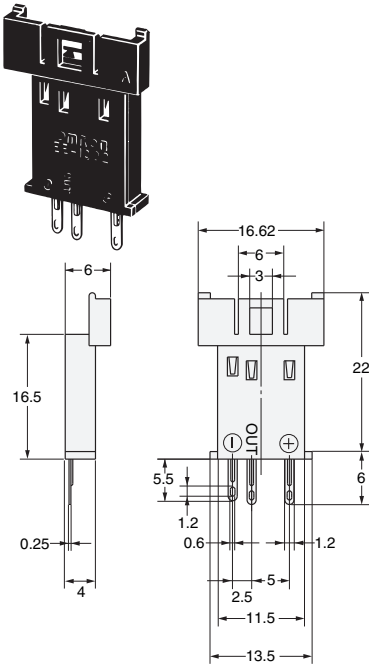

Connector with Cable

EE-1003

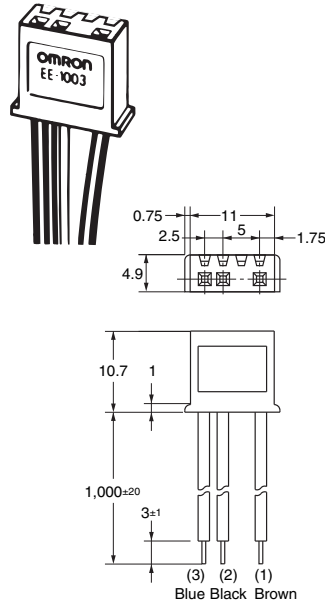

Cable:
1.61-dia. 1-conductor vinyl-insulated round cable
(Conductor cross section: 0.33 mm²).

Connector Hold-down Clips (For EE-1003 only)

EE-1003A

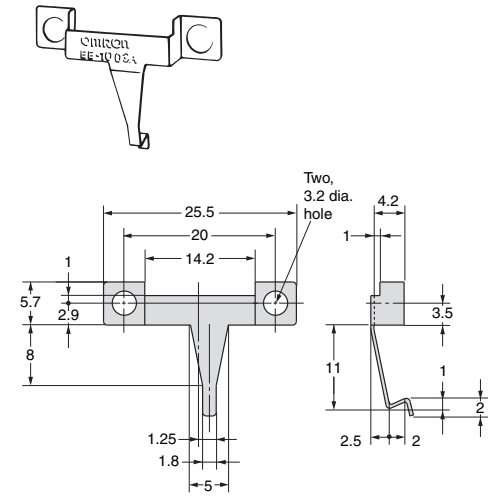

Applicable
Photomicrosensors

EE-SPX301/401, EE-SPY30□/40□, EE-SPZ301-A/401-A

Connector with Cable

EE-1013

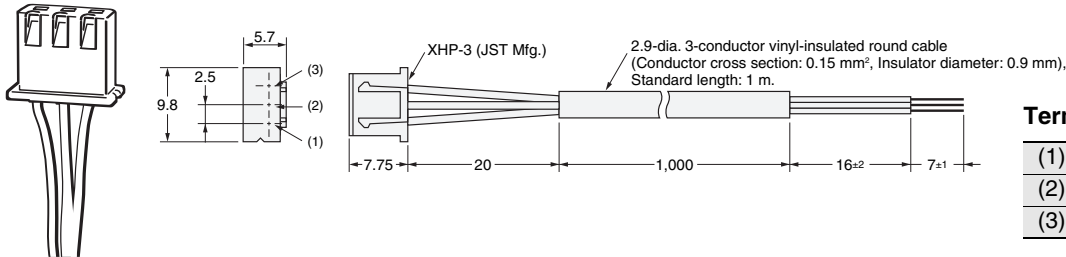

XHP-3 (JST Mfg.)
2.9-dia. 3-conductor vinyl-insulated round cable
(Conductor cross section: 0.15 mm², Insulator diameter: 0.9 mm,
Standard length: 1 m).

Terminal Arrangement

(1)	Blue	GND(0V)
(2)	Black	OUTPUT
(3)	Brown	Vcc

Applicable
Photomicrosensors

EE-SPX74□/84□

Connector with Cable

EE-1017

Connector with Robot Cable

EE-1017-R

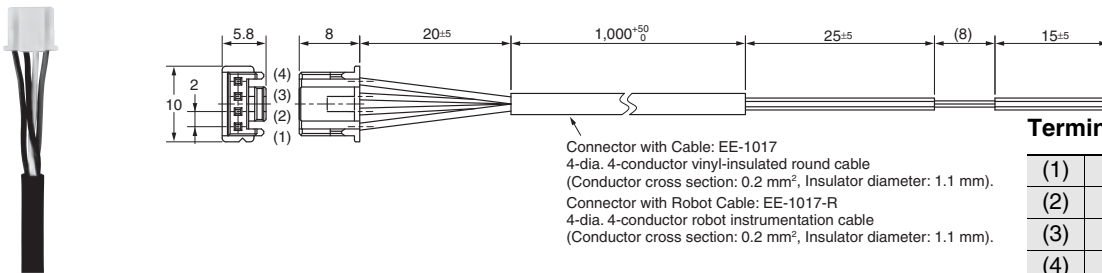

Connector with Cable: EE-1017
4-dia. 4-conductor vinyl-insulated round cable
(Conductor cross section: 0.2 mm², Insulator diameter: 1.1 mm).
Connector with Robot Cable: EE-1017-R
4-dia. 4-conductor robot instrumentation cable
(Conductor cross section: 0.2 mm², Insulator diameter: 1.1 mm).

Terminal Arrangement

(1)	⊕	Brown
(2)	1	Black
(3)	2	White
(4)	⊖	Blue

Applicable
Photomicrosensors

EE-SX97□-C1, EE-SX97□P-C1

NPN to PNP Transistor Output Conversion Connectors

NPN/PNP Conversion Connector

EE-2001

Terminal Arrangement

(1)	⊕	Brown
(2)	OUT	Black
(3)	⊖	Blue

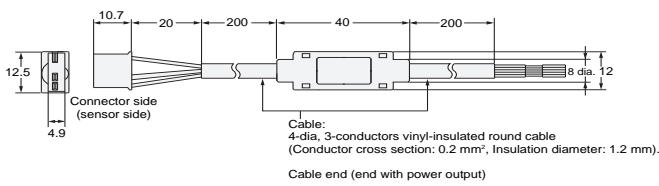
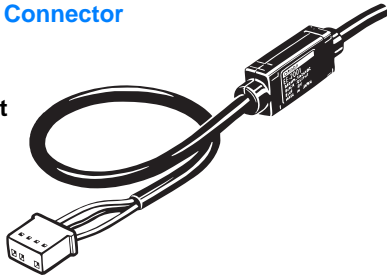

NPN/PNP Conversion Connector

EE-2002 *

Terminal Arrangement

(1)	⊕	Brown
(2)	OUT	Black
(3)	⊖	Blue

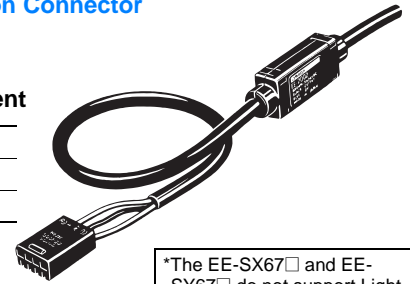

*The EE-SX67□ and EE-SY67□ do not support Light-ON mode.

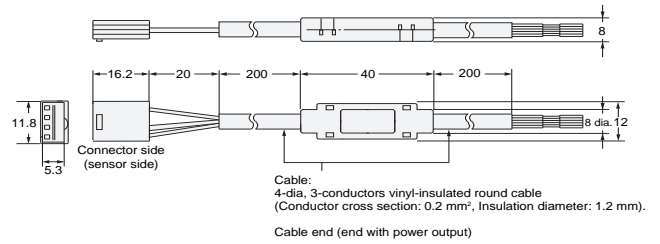

Applicable Photomicrosensors

EE-SPX301/401, EE-SPY30□/40□,
EE-SPZ301-A/401-A

EE-SX67□/□A (Connector Models only), EE-SX47□,
EE-SY67□, EE-SPY31□/41□,
EE-SPX303N/403N, EE-SPW311/411

Terms and Conditions Agreement

Read and understand this catalog.

Please read and understand this catalog before purchasing the products. Please consult your OMRON representative if you have any questions or comments.

Warranties.

(a) Exclusive Warranty. Omron's exclusive warranty is that the Products will be free from defects in materials and workmanship for a period of twelve months from the date of sale by Omron (or such other period expressed in writing by Omron). Omron disclaims all other warranties, express or implied.

(b) Limitations. OMRON MAKES NO WARRANTY OR REPRESENTATION, EXPRESS OR IMPLIED, ABOUT NON-INFRINGEMENT, MERCHANTABILITY OR FITNESS FOR A PARTICULAR PURPOSE OF THE PRODUCTS. BUYER ACKNOWLEDGES THAT IT ALONE HAS DETERMINED THAT THE PRODUCTS WILL SUITABLY MEET THE REQUIREMENTS OF THEIR INTENDED USE.

Omron further disclaims all warranties and responsibility of any type for claims or expenses based on infringement by the Products or otherwise of any intellectual property right. (c) Buyer Remedy. Omron's sole obligation hereunder shall be, at Omron's election, to (i) replace (in the form originally shipped with Buyer responsible for labor charges for removal or replacement thereof) the non-complying Product, (ii) repair the non-complying Product, or (iii) repay or credit Buyer an amount equal to the purchase price of the non-complying Product; provided that in no event shall Omron be responsible for warranty, repair, indemnity or any other claims or expenses regarding the Products unless Omron's analysis confirms that the Products were properly handled, stored, installed and maintained and not subject to contamination, abuse, misuse or inappropriate modification. Return of any Products by Buyer must be approved in writing by Omron before shipment. Omron Companies shall not be liable for the suitability or unsuitability or the results from the use of Products in combination with any electrical or electronic components, circuits, system assemblies or any other materials or substances or environments. Any advice, recommendations or information given orally or in writing, are not to be construed as an amendment or addition to the above warranty.

See <http://www.omron.com/global/> or contact your Omron representative for published information.

Limitation on Liability; Etc.

OMRON COMPANIES SHALL NOT BE LIABLE FOR SPECIAL, INDIRECT, INCIDENTAL, OR CONSEQUENTIAL DAMAGES, LOSS OF PROFITS OR PRODUCTION OR COMMERCIAL LOSS IN ANY WAY CONNECTED WITH THE PRODUCTS, WHETHER SUCH CLAIM IS BASED IN CONTRACT, WARRANTY, NEGLIGENCE OR STRICT LIABILITY.

Further, in no event shall liability of Omron Companies exceed the individual price of the Product on which liability is asserted.

Suitability of Use.

Omron Companies shall not be responsible for conformity with any standards, codes or regulations which apply to the combination of the Product in the Buyer's application or use of the Product. At Buyer's request, Omron will provide applicable third party certification documents identifying ratings and limitations of use which apply to the Product. This information by itself is not sufficient for a complete determination of the suitability of the Product in combination with the end product, machine, system, or other application or use. Buyer shall be solely responsible for determining appropriateness of the particular Product with respect to Buyer's application, product or system. Buyer shall take application responsibility in all cases.

NEVER USE THE PRODUCT FOR AN APPLICATION INVOLVING SERIOUS RISK TO LIFE OR PROPERTY OR IN LARGE QUANTITIES WITHOUT ENSURING THAT THE SYSTEM AS A WHOLE HAS BEEN DESIGNED TO ADDRESS THE RISKS, AND THAT THE OMRON PRODUCT(S) IS PROPERLY RATED AND INSTALLED FOR THE INTENDED USE WITHIN THE OVERALL EQUIPMENT OR SYSTEM.

Programmable Products.

Omron Companies shall not be responsible for the user's programming of a programmable Product, or any consequence thereof.

Performance Data.

Data presented in Omron Company websites, catalogs and other materials is provided as a guide for the user in determining suitability and does not constitute a warranty. It may represent the result of Omron's test conditions, and the user must correlate it to actual application requirements. Actual performance is subject to the Omron's Warranty and Limitations of Liability.

Change in Specifications.

Product specifications and accessories may be changed at any time based on improvements and other reasons. It is our practice to change part numbers when published ratings or features are changed, or when significant construction changes are made. However, some specifications of the Product may be changed without any notice. When in doubt, special part numbers may be assigned to fix or establish key specifications for your application. Please consult with your Omron's representative at any time to confirm actual specifications of purchased Product.

Errors and Omissions.

Information presented by Omron Companies has been checked and is believed to be accurate; however, no responsibility is assumed for clerical, typographical or proofreading errors or omissions.