

# High Performance Display Units : RS485 / + Pt Input



## DS / DA Series CATALOG

For your safety, read and follow the considerations written in the instruction manual, other manuals and Autonics website.

The specifications, dimensions, etc. are subject to change without notice for product improvement. Some models may be discontinued without notice.

### Features

- Simple wiring without soldering
  - multi-stage connection using expansion connectors or ribbon cables.
  - power supply and data wiring required on base unit only.
- Various input options
  - Serial input
  - Dynamic Parallel input
  - RS485 communication (Modbus) input (Master, Slave)
  - RS485 communication (Modbus) time sync display
  - PT temperature sensor input
  - PT temperature sensor + RS485 communication input
- Expandable up to 24 units with multi-stage connection
- Available in various sizes: 16 mm, 22.5 mm, 40 mm, 60 mm
- High luminance LED display
- Various unit display plates (switchable) with flashing or ON/OFF options
- Various display types
  - 7-segment display and 16-segment
  - Red and green display types
  - Display 64 characters (0 to 9, A to Z, 27 symbols, decimal point)

### Ordering Information

This is only for reference, the actual product does not support all combinations. For selecting the specified model, follow the Autonics website.

**D** **S** **①** - **R** **②**

#### ① Size

22: W 20 × H 33 mm  
40: W 40 × H 60 mm  
60: W 60 × H 96 mm

#### ② Input method (basic unit)

R: Pt temperature sensor input  
RT: Pt temperature sensor input +  
RS485 communication output

### Product Components

- Product
- Instruction manual
- 22 mm Cap (left-right 1 set) × 1
- 22 mm Connector × 1

### Software

- Download the installation file and the manuals from the Autonics website.

#### ■ DAQMaster

- DAQMaster is the comprehensive device management program for Autonics' products, providing parameter setting, monitoring and data management.

### Specifications

Model	D□22-□□	D□40-□□	D□60-□□
Display color	Red		
Power supply	12 - 24 VDC≒		
Allowable voltage range	90 to 110 % of power supply		
Current consumption (red)	≤ 25 mA	≤ 55 mA	≤ 65 mA
Current consumption (green)	≤ 20 mA	≤ 40 mA	≤ 45 mA
Size (W×H)	11.2 × 22.5 mm	22.4 × 40 mm	33.6 × 60 mm
Noise immunity	±500 V the square wave noise (pulse width: 1 μs) by the noise simulator		
Ambient temperature	-10 to 55 °C, storage: -25 to 65 °C (no freezing or condensation)		
Ambient humidity	35 to 85 %RH, storage: 35 to 85 %RH (no freezing or condensation)		
Protection structure	IP40 (front part)		
Approval	CE ENEC		
Weight (packaged) <sup>01)</sup>	≈ 17 g (≈ 58 g)	≈ 28 g (≈ 63 g)	≈ 60 g (≈ 110 g)

01) The package weight of 16 mm / 22 mm expansion unit varies, it based on 3 packages.  
16 mm: ≈ 77 g / 22 mm: ≈ 92 g

Model	DS□-RR	DS□-RRT
Input method	Pt temperature sensor	Pt temperature sensor
Output	-	RS485 communication
Input sensor	DPt100Ω, JPt 100Ω	
Display character (range)	-50.0 to 400.0 °C or -58.0 to 752.0 °F • Display accuracy: F.S. ± 0.5 %	
Max. number of multi-stage	4-unit (except unit-display unit)	

### Communication Interface

#### ■ RS485

Protocol	Modbus RTU
Application standard	Compliance with EIA RS485
Max. connections (setting address)	8 units (01 to 08)
Comm. type	Two-wire half duplex
Comm. distance	Max. 800 m
Comm. speed	9600, 38400 bps
Comm. response time	5 ms (fixed)
Start bit	1 bit (fixed)
Data bit	8 bits (fixed)
Parity bit	NONE (fixed)
Stop bit	1 bit (fixed)

## Dimensions

- Unit: mm, For the detailed drawings, follow the Autonics website.
- N: number of units

### 22 mm size

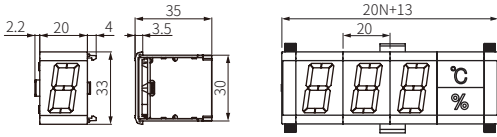

### 40 mm size

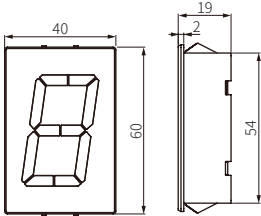

### 60 mm size

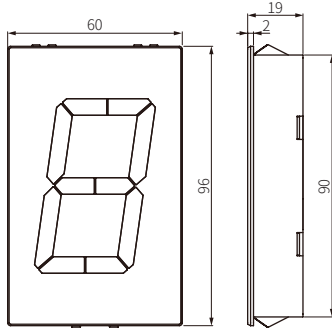

### Panel cut-out

- Panel thickness: 1.5 to 4 mm

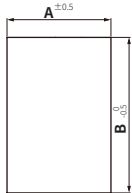

Model	A	B
22 mm	20N+11	31
40 mm	40N-2	55
60 mm	60N-3	91

### Connector

- 22 mm size

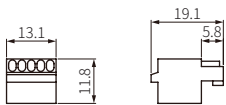

### Cap

- 22 mm size

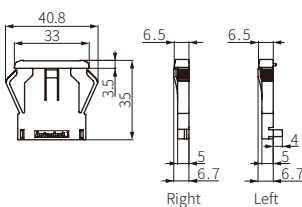

## Unit Descriptions

- Temperature sensor input + RS485 communication output model support S5 / J1 to J4 switch, 6 and 7 of the input terminal.
- Activate Zero Blanking function automatically.

### 22 mm size

Side

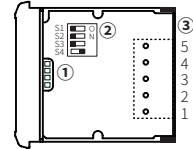

### 40 mm size

Rear

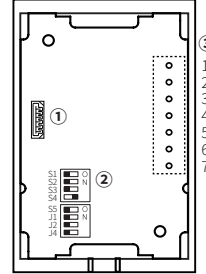

### 60 mm size

Rear

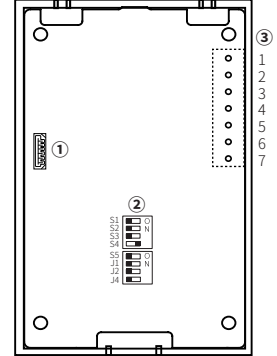

① **Expansion connector** Using for connecting expansion unit. See 'Connection of Units.'

② **Function set switches** Basic unit only

No.	Switch OFF (■□)	Switch ON (□■)	Function	Default			
S1	DPT100Ω	JPt100Ω	Temperature sensor	OFF			
S2	°C	°F	Temperature unit	OFF			
S3	10 <sup>2</sup>	10 <sup>1</sup>	Integer display	OFF			
S4	Not used	Use	Decimal point	ON			
S5	9600 bps	38400 bps	Comm. speed (bps)	OFF			
	1	2	...	7	8		
J1	ON	OFF	...	ON	OFF	Comm. address	OFF
J2	OFF	ON	...	ON	OFF		
J4	OFF	OFF	...	ON	OFF		

③ **Input terminal** Basic unit only

No.	Code	Function
1	VCC	12 - 24 VDC =
2	GND	0 V
3	A	Pt temperature sensor A input
4	B	Pt temperature sensor B input
5	B'	Pt temperature sensor B input
6	A (+)	RS485 A (+) output
7	B (-)	RS485 B (-) output

• Connections

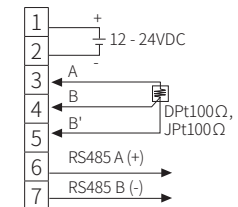

- The basic unit supplies the power for expansion unit and the unit-display unit and DATA input.
- For the 22 mm size model, connect the connector to the input terminal.

## Sold Separately

- Expansion unit (DS□-RE)
  - : select the same size/display color of basic unit (available to mix the display method)
- 22 mm Middle bracket (BK-D22R)
- 22 mm Unit-display unit (DU22-□)

## Sold Separately: 22 mm Unit-display Unit (DU Series)

- This unit is for displaying unit by inserting a name plate.
- Name plate type
  - Single: °C / °F / sec / min / h / g / kg / mm / cm / m / rpm / % / ppm / pcs / pH / A / V / W / VA
  - Dual-stage (top-bottom): °C - °F / °C - %
- Select the same size with the basic / expansion unit.

### ■ Name plate insertion

Remove the protection sheet and insert the name plate at between the case and the reflector.

**⚠ Caution: Be sure to insert it with the correct direction.**

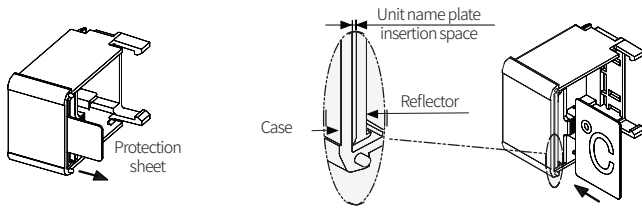

### ■ Input data chart

- The unit-display unit does not use the upper bit over D4. (Don't care: X)
- It is only available to use the unit-display unit with Serial 5-bit, Parallel Dynamic 1 input when connecting the unit-display unit at the right side and turning ON. Do not input data to the unit-display unit.

Unit-display unit		High 2-bit			
		D3	D2	D1	D0
D5	D4				
X	X				
No unit		L	L	L	L
Top-bottom OFF		L	L	L	H
Top-bottom ON		L	L	H	L
Top ON		L	L	H	H
Bottom ON		L	H	L	L
Top-bottom flashing		L	H	L	H
Top flashing		L	H	H	L
Bottom flashing		L	H	H	H
If the data is not for the unit-display unit, it maintains former state.		H	L	L	L
		H	L	L	H
		H	L	H	L
		H	L	H	H
		H	H	L	L
		H	H	L	H
		H	H	H	L
		H	H	H	H

### ■ Zero Blanking

#### • Using the unit-display unit

If sending unit data signal after data 1 (00123), it applies Zero Blanking function when displaying data 2 (04567).

0	1	2	3	%	4	5	6	7
---	---	---	---	---	---	---	---	---

Do not transfer unit data to basic/expansion unit. Unit bit (D7) of unit data is only for unit. If transferring unit data to basic/expansion unit, unit bit (D7) displays the ignored data value. In this case, Zero Blanking does not operate normally.

#### • Not using the unit-display unit

No-unit data (HXXXXLLL) is used for data delimiter.

If sending no-unit data after data 1 (00123), it applies Zero Blanking function to display data 2. In this case, transmitted data should be added no-unit data to the display digits.

0	1	2	3	4	5	6	7
---	---	---	---	---	---	---	---

If it does not send no-unit data, it displays data 1 (00123) and data 2 (04567) as one data. Zero Blanking function is applied to data 1 only.

0	1	2	3	0	4	5	6	7
---	---	---	---	---	---	---	---	---

## Sold Separately: 22 mm Middle Bracket (BK-D22R)

- Unit: mm, For the detailed drawings, follow the Autonics website.

