

Air Cylinder

CJ2 Series

ø6, ø10, ø16

Double foot Head flange
Double-side bossed are
added to the
mounting types.

4 types → 7 types

For ø6, 3 types → 6 types

Improved amount of
mounting freedom

Head cover with
boss is added.

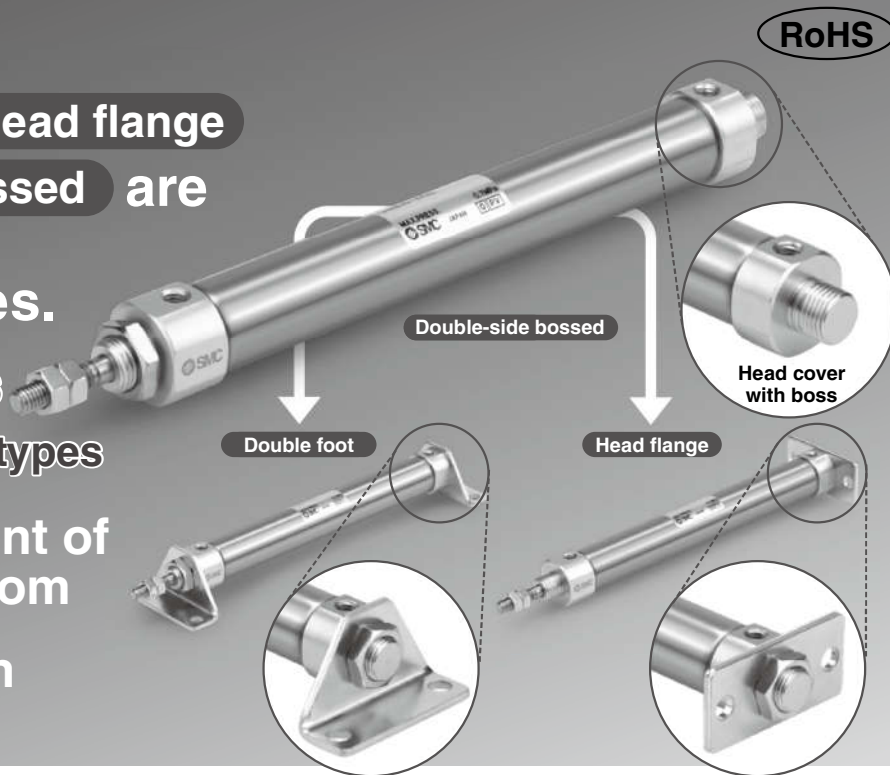

CJ1

CJP

CJ2

JCM

CM2

CM3

CG1

CG3

JMB

MB

MB1

CA2

CS1

CS2

Easy fine adjustment of auto switch position

Fine adjustment of the auto switch position is possible by simply loosening the screw attached to the auto switch.

Transparent switch bracket improves visibility of indicator LED.

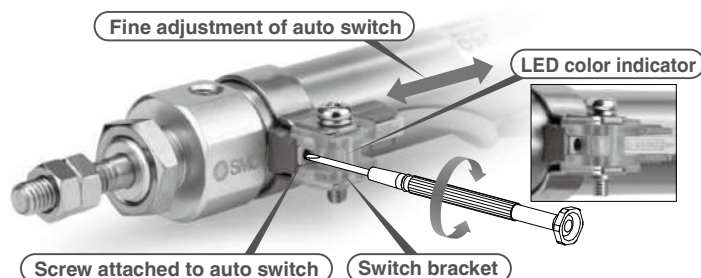

Head cover port location “Perpendicular to axis” is newly added to ø6.

Improved piping flexibility

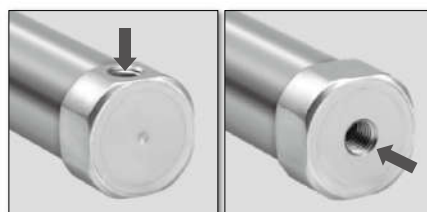

ø6	●	○
ø10	○	○
ø16	○	○



D-□

-X□

Technical
Data

Mounting/Rod end brackets/Accessories (page 63)

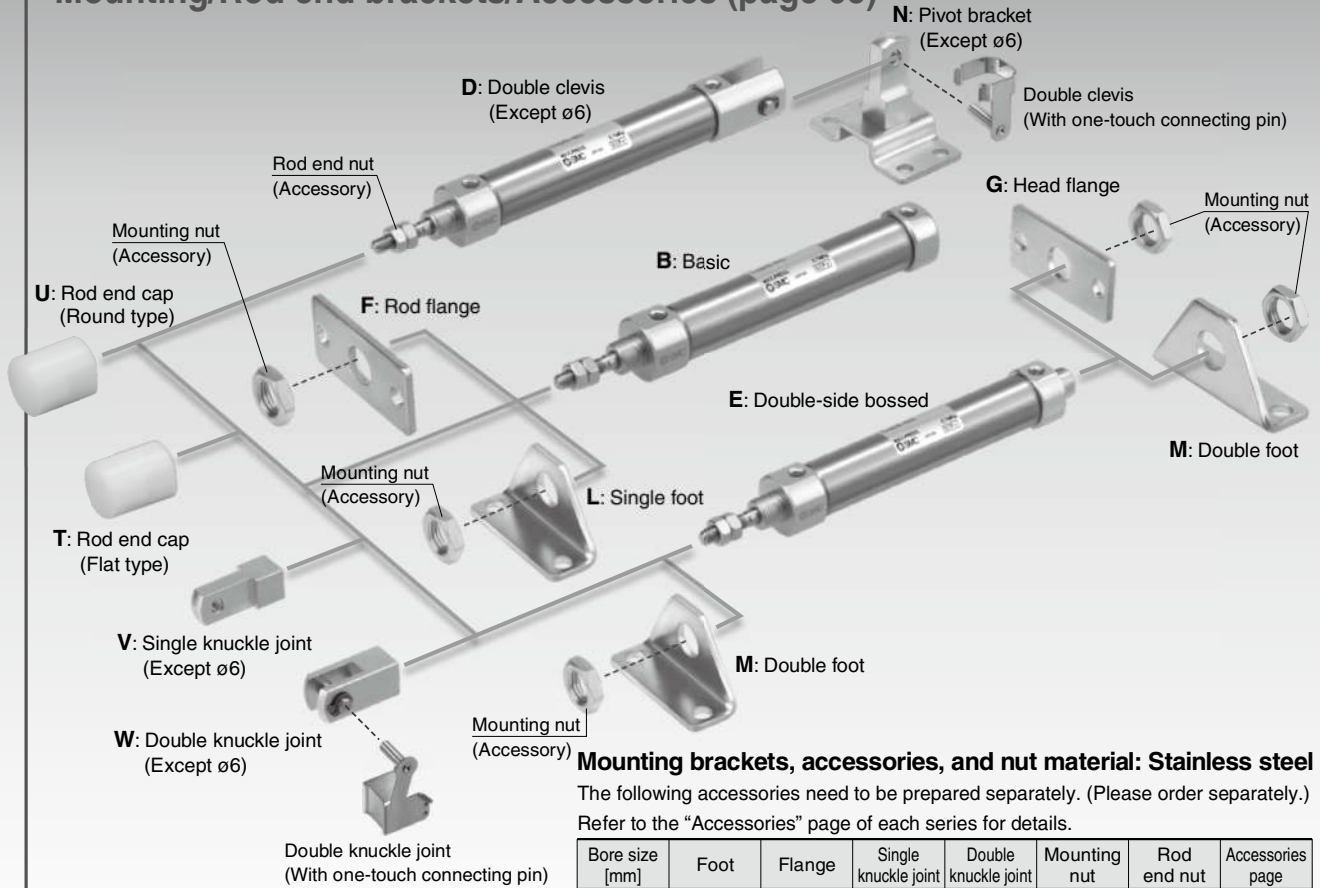

Mounting brackets, accessories, and nut material: Stainless steel

The following accessories need to be prepared separately. (Please order separately.) Refer to the "Accessories" page of each series for details.

Bore size [mm]	Foot	Flange	Single knuckle joint	Double knuckle joint	Mounting nut	Rod end nut	Accessories page
10, 16	○*	○*	○	○	○*	○	p. 63-1

*: Except bore size 10.

Part numbers with rod end bracket and/or pivot bracket available

Not necessary to order a bracket for the applicable cylinder separately

Note) Mounting bracket is shipped together with the product, but not assembled.

Example) **CDJ2D16-50Z- N W -M9BW-B**

Pivot bracket	
Nil	None
N	Pivot bracket is shipped together with the product, but not assembled.

*: Only for the double clevis type ($\phi 10$ and $\phi 16$)



Rod end bracket	
Nil	None
V	Single knuckle joint
W	Double knuckle joint
T	Rod end cap (Flat type)
U	Rod end cap (Round type)

*: V/W: $\phi 10$ and $\phi 16$ only

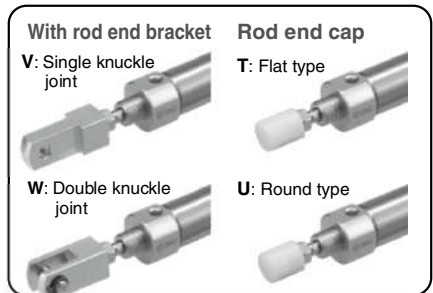

Refer to page 151-1 for the part number (-X2838) of the double clevis (with one-touch connecting pin).

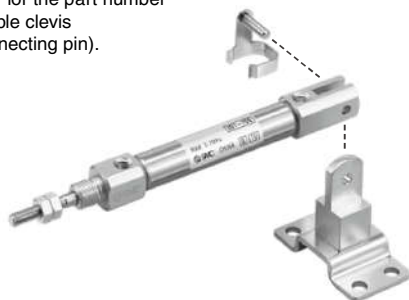

Refer to page 63 for the double knuckle joint (with one-touch connecting pin).

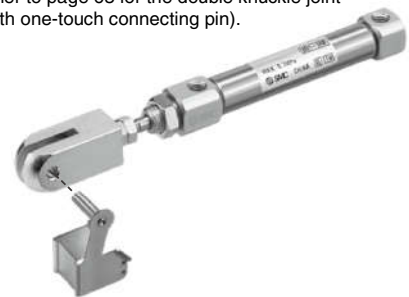

Compact auto switches

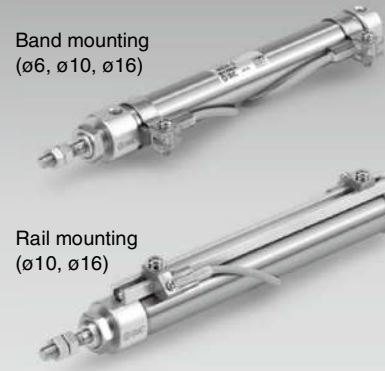
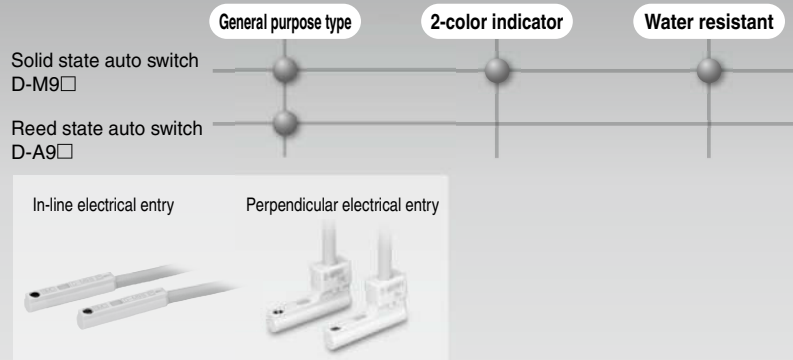

- CJ1**
- CJP**
- CJ2**
- JCM**
- CM2**
- CM3**
- CG1**
- CG3**
- JMB**
- MB**
- MB1**
- CA2**
- CS1**
- CS2**

Stroke Variations

Bore size [mm]	Standard stroke									
	15	30	45	60	75	100	125	150	175	200
6	●	●	●	●	●	●	●	●	●	●
10	●	●	●	●	●	●	●	●	●	●
16	●	●	●	●	●	●	●	●	●	●

Series Variations

Series	Action	Type	Bore size [mm]			Variations		Page
			6	10	16	Built-in magnet	Air cushion	
Standard CJ2-Z	Double acting	Single rod	●	●	●	●	●	46
	Double acting	Double rod	●	●	●	●	●	64
	Single acting	Single rod (Spring return /extend)	●	●	●	●	●	71
Non-rotating rod CJ2K-Z	Double acting	Single rod	●	●	●	●	●	88
	Single acting	Single rod (Spring return /extend)	●	●	●	●	●	95
Built-in speed controller CJ2Z-Z	Double acting	Single rod	●	●	●	●	●	107
	Double acting	Double rod	●	●	●	●	●	114
Direct mount CJ2R-Z	Double acting	Single rod	●	●	●	●	●	119
	Single acting	Single rod (Spring return /extend)	●	●	●	●	●	123
Direct mount, Non-rotating rod CJ2RK-Z	Double acting	Single rod	●	●	●	●	●	127
	Single acting	Single rod (Spring return /extend)	●	●	●	●	●	130
With end lock CBJ2	Double acting	Single rod	●	●	●	●	●	134
Smooth Cylinder CJ2Y-Z	Double acting	Single rod	●	●	●	●	●	Best Pneumatics No. 2-3
Low Speed Cylinder CJ2X-Z	Double acting	Single rod	●	●	●	●	●	Best Pneumatics No. 2-3

*: The air cylinder with end lock has the same shape as the current product.

*: Air cushion is only available for ø10 and ø16.

- D-□**
- X□**
- Technical Data

CONTENTS

Air Cylinder *CJ2 Series*



■ Air Cylinder: Standard Type Double Acting, Single Rod CJ2 Series

How to Order	P.46
Specifications	P.47
Construction	P.49
Dimensions	P.50
Dimensions of Accessories (Options)	P.63
Precautions	P.63-2



■ Air Cylinder: Standard Type Double Acting, Double Rod CJ2W Series

How to Order	P.64
Specifications	P.65
Construction	P.67
Dimensions	P.68



■ Air Cylinder: Standard Type Single Acting, Spring Return/Extend CJ2 Series

How to Order	P.71
Specifications	P.72
Construction	P.74
Dimensions	P.75



■ Air Cylinder: Non-rotating Rod Type Double Acting, Single Rod CJ2K Series

How to Order	P.88
Specifications	P.89
Construction	P.90
Dimensions	P.91



■ Air Cylinder: Non-rotating Rod Type Single Acting, Spring Return/Extend CJ2K Series

How to Order	P.95
Specifications	P.96
Construction	P.98
Dimensions	P.99



■ Air Cylinder: Built-in Speed Controller Type Double Acting, Single Rod CJ2Z Series

How to Order	P.107
Specifications	P.108
Construction	P.109
Dimensions	P.110



■ **Air Cylinder: Built-in Speed Controller Type**
Double Acting, Double Rod CJ2ZW Series

How to Order P.114
 Specifications P.115
 Construction P.116
 Dimensions P.117

- CJ1
- CJP
- CJ2



■ **Air Cylinder: Direct Mount Type**
Double Acting, Single Rod CJ2R Series

How to Order P.119
 Specifications P.120
 Construction P.122

- JCM
- CM2
- CM3



■ **Air Cylinder: Direct Mount Type**
Single Acting, Spring Return/Extend CJ2R Series

How to Order P.123
 Specifications P.124
 Construction P.125
 Dimensions P.126

- CG1
- CG3
- JMB
- MB



■ **Air Cylinder: Direct Mount, Non-rotating Rod Type**
Double Acting, Single Rod CJ2RK Series

How to Order P.127
 Specifications P.128
 Construction P.129
 Dimensions P.129

- MB1
- CA2
- CS1
- CS2



■ **Air Cylinder: Direct Mount, Non-rotating Rod Type**
Single Acting, Spring Return/Extend CJ2RK Series

How to Order P.130
 Specifications P.131
 Construction P.132
 Dimensions P.133



■ **Air Cylinder: With End Lock CBJ2 Series**

How to Order P.134
 Specifications P.135
 Construction P.136
 Dimensions P.137
 Specific Product Precautions P.141

Auto Switch Mounting P.142
 Made to Order: Individual Specifications P.150
 Specific Product Precautions P.152

- D-□
- X□
- Technical Data

Combinations of Standard Products and Made to Order Specifications

CJ2 Series

- : Standard
- ◎ : Made to Order
- : Special product (Please contact SMC for details.)
- : Not available

Series	CJ2 (Standard type)				CJ2K (Non-rotating rod type)			Page
	Double acting		Single acting		Double acting	Single acting		
	Single rod	Double rod	Single rod (spring return)	Single rod (spring extend)	Single rod	Single rod (spring return)	Single rod (spring extend)	
	46	64	71		88	95		

Symbol	Specifications	Applicable bore size	ø6 to ø16				ø10, ø16		
Standard	Standard	ø6 to ø16	●	●	●	●	●	●	●
D	Built-in magnet		●	●	●	●	●	●	●
CJ2□-□A	Air cushion	ø10, ø16	●	●	—	—	—	—	—
10-, 11-	Clean series*1	ø6 to ø16	●	●*9	○	○	—	—	—
25A-	Copper (Cu) and Zinc (Zn)-free*5	ø10, ø16	●	○	○	○	○	○	○
XB6	Heat resistant cylinder (-10 to 150°C)*3, 4	ø6 to ø16	◎	◎	○	○	○	○	○
XB7	Cold resistant cylinder (-40 to 70°C)*3, 4		◎	◎	○	○	○	○	○
XB9	Low speed cylinder (10 to 50 mm/s)*4		◎	—	—	—	—	—	—
XB13	Low speed cylinder (5 to 50 mm/s)	ø6	◎	—	—	—	—	—	—
XC3	Special port position*2, 4	ø6 to ø16	◎	○	—	—	◎	—	—
XC8	Adjustable stroke cylinder/ Adjustable extension type*4	ø10, ø16	◎	—	○	○	○	○	○
XC9	Adjustable stroke cylinder/ Adjustable retraction type*4		◎	—	○	—	◎	○	—
XC10	Dual stroke cylinder/Double rod type*4		◎	—	○	○	◎	○	○
XC11	Dual stroke cylinder/Single rod type*4		◎	—	—	—	○	—	—
XC22	Fluororubber seal*4	ø6 to ø16	◎	◎	◎	◎	◎	○	○
XC51	With hose nipple		◎	◎	◎	◎	◎	◎	◎
XC85	Grease for food processing equipment	ø10, ø16	◎	◎	◎	◎	◎	◎	◎
X446	PTFE grease		◎	◎	◎	◎	◎	◎	◎
X773	Short pitch mounting	ø6	—	—	◎	—	—	—	—
X2838	Double clevis (With one-touch connecting pin)*11	ø10, ø16	◎	—	◎	◎	◎	◎	◎

*1: Mounting type: Not compatible with the clevis type.
 An auto switch is available in the band mounting type only.
 *2: An auto switch is available in the band mounting type only.
 *3: The products with an auto switch are not compatible.
 *4: The products with an air cushion are not compatible.
 *5: For details, refer to the **Web Catalog**.

*6: The shape is the same as the current product.
 *7: Available only for locking at head end.
 *8: Available only for locking at rod end.
 *9: ø10 and ø16 only
 *10: Copper and fluorine-free [20-] are available as standard products.
 *11: Not compatible with the air cushion or rail mounting type auto switches.

	CJ2Z (Built-in speed controller type)		CJ2R (Direct mount type)			CJ2RK (Direct mount, Non-rotating rod type)			CBJ2 (With end lock)*6	CJ2Y Smooth Cylinder	CJ2X Low Speed Cylinder	Symbol
	Double acting		Double acting	Single acting		Double acting	Single acting		Double acting	Double acting	Double acting	
	Single rod	Double rod	Single rod	Single rod (spring return)	Single rod (spring extend)	Single rod	Single rod (spring return)	Single rod (spring extend)	Single rod	Single rod	Single rod	
	107	114	119	123		127	130		134	Best Pneumatics No. 2-3	Best Pneumatics No. 2-3	
	ø10, ø16								ø16	ø10, ø16	ø10, ø16	
	●	●	●	●	●	●	●	●	●	●	●	Standard
	●	●	●	●	●	●	●	●	●	●	●	D
	—	—	○	—	—	—	—	—	—	—	—	CJ2□-□A
	—	—	●	○	○	—	—	—	○*7	—	—	10-, 11-
	○	○	○	○	○	○	○	○	○	○	○	25A-
	○	○	○	○	○	○	○	○	○	—	—	XB6
	○	○	○	○	○	○	○	○	—	—	—	XB7
	—	—	—	—	—	—	—	—	○	—	—	XB9
	—	—	—	—	—	—	—	—	—	—	—	XB13
	—	—	○	—	—	○	—	—	○	◎	○	XC3
	○	—	○	○	○	○	○	○	—	—	—	XC8
	—	—	◎	○	—	◎	○	—	○*8	◎	—	XC9
	○	—	○	○	○	○	○	○	○	○	—	XC10
	—	—	○	—	—	○	—	—	○*8	—	—	XC11
	○	○	◎	○	○	○	○	○	○	—	—	XC22
	◎	◎	◎	◎	◎	◎	◎	◎	—	—	—	XC51
	◎	◎	◎	◎	◎	◎	◎	◎	—	—	—	XC85
	◎	◎	◎	◎	◎	◎	◎	◎	—	—	—	X446
	—	—	—	—	—	—	—	—	—	—	—	X773
	—	—	—	—	—	—	—	—	—	○	○	X2838

- CJ1
- CJP
- CJ2**
- JCM
- CM2
- CM3
- CG1
- CG3
- JMB
- MB
- MB1
- CA2
- CS1
- CS2

- D-□
- X□
- Technical Data

Air Cylinder: Direct Mount Type Double Acting, Single Rod

CJ2R Series

ø10, ø16

RoHS



How to Order

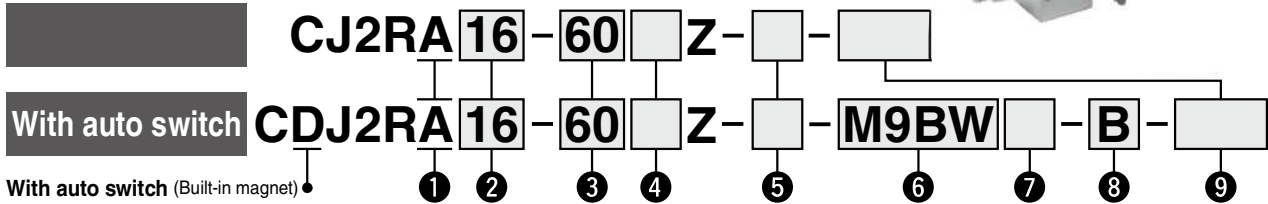

1 Mounting

A	Bottom mounting
----------	-----------------

2 Bore size

10	10 mm
16	16 mm

3 Cylinder standard stroke [mm]
Refer to "Standard Strokes" on page 120.

4 Head cover port location

Nil	Perpendicular to axis	
R	Axial	

5 Rod end bracket

Nil	None
V	Single knuckle joint
W**	Double knuckle joint
T	Rod end cap (Flat type)
U	Rod end cap (Round type)

6 Auto switch

Nil	Without auto switch
------------	---------------------

*: For applicable auto switches, refer to the table below.
★ Enter the auto switch mounting type (A or B) even when a built-in magnet cylinder without an auto switch is required.

7 Number of auto switches

Nil	2 pcs.
S	1 pc.
n	"n" pcs.

8 Auto switch mounting type

A	Rail mounting
B	Band mounting

9 Made to Order
Refer to page 120 for details.

*: For rail mounting, screws and nuts for 2 auto switches come with the rail.
*: Refer to page 148 for auto switch mounting brackets.

*: Refer to "Ordering Example of Cylinder Assembly" on page 120.

Applicable Auto Switches/Refer to pages 1575 to 1701 for further information on auto switches.

Type	Special function	Electrical entry	Indicator light	Wiring (Output)	Load voltage		Auto switch model				Lead wire length [m]					Pre-wired connector	Applicable load				
					DC	AC	Band mounting		Rail mounting		0.5 (Nil)	1 (M)	3 (L)	5 (Z)	None (N)						
							In-line	Perpendicular	In-line	Perpendicular											
Solid state auto switch		Grommet	No	3-wire (NPN)	5 V, 12 V		M9NV	M9N	M9NV	M9N	●	●	●	○	○	IC circuit	Relay, PLC				
				3-wire (PNP)			M9PV	M9P	M9PV	M9P	●	●	●	○	○						
		Connector	No	2-wire	12 V	M9BV	M9B	M9BV	M9B	●	●	●	○	○	—						
				—		H7C	J79C	—	●	—	●	●	—	—							
	Diagnostic indication (2-color indicator)	Grommet	Yes	3-wire (NPN)	5 V, 12 V	—	M9NWV	M9NW	M9NWV	M9NW	●	●	●	○	○	IC circuit					
				3-wire (PNP)			M9PWV	M9PW	M9PWV	M9PW	●	●	●	○	○						
				2-wire			M9BWV	M9BW	M9BWV	M9BW	●	●	●	○	○	—					
				3-wire (NPN)			M9NAV*1	M9NA*1	M9NAV*1	M9NA*1	○	○	○	○	○						
				3-wire (PNP)			M9PAV*1	M9PA*1	M9PAV*1	M9PA*1	○	○	○	○	○						
				2-wire			M9BAV*1	M9BA*1	M9BAV*1	M9BA*1	○	○	○	○	○						
Reed auto switch		Grommet	Yes	3-wire (NPN equivalent)	5 V	—	A96V	A96	A96V	A96	●	—	●	—	—	IC circuit	Relay, PLC				
				—			—	—	A72	A72H	●	—	●	—	—						
				—			200 V	—	—	—	—	—	—	—	—			—			
				—			100 V	A93V*2	A93	A93V*2	A93	●	●	●	●				—		
		Connector	No	No	2-wire	24 V	12 V	100 V or less	A90V	A90	A90V	A90	●	—	●	—		—	IC circuit		
					—			—	C73C	A73C	—	—	—	—	—	—					
					—			—	—	C80C	A80C	—	—	●	—			●		●	—
					—			24 V or less	—	—	A79W	—	—	—	—	—		—		—	—

*1: Water resistant type auto switches can be mounted on the above models, but in such case SMC cannot guarantee water resistance. Please contact SMC regarding water resistant types with the above model numbers.
*2: 1 m type lead wire is only applicable to D-A93.
*: Lead wire length symbols: 0.5 m..... Nil (Example) M9NW
1 m..... M (Example) M9NWM
3 m..... L (Example) M9NWL
5 m..... Z (Example) M9NWZ
*: Since there are other applicable auto switches than listed, refer to page 149 for details.
*: Solid state auto switches marked with "○" are produced upon receipt of order.
*: The D-A9□/M9□/A7□/A80□/F7□/J7□ auto switches are shipped together, but not assembled. (For band mounting, only auto switch mounting brackets are assembled before being shipped.)

- CJ1
- CJP
- CJ2**
- JCM
- CM2
- CM3
- CG1
- CG3
- JMB
- MB
- MB1
- CA2
- CS1
- CS2

- D-□
- X□
- Technical Data

CJ2R Series

The CJ2R direct mount cylinder can be installed directly through the use of a square rod cover.



Symbol

Double acting, Single rod, Rubber bumper

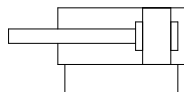

Made to Order: Individual Specifications
(For details, refer to page 150.)

Symbol	Specifications
-X446	PTFE grease

Made to Order

[Click here for details](#)

Symbol	Specifications
-XA□	Change of rod end shape
-XC9	Adjustable stroke cylinder/Adjustable retraction type
-XC22	Fluororubber seal
-XC51	With hose nipple
-XC85	Grease for food processing equipment



Precautions

Refer to page 152 before handling.

Ordering Example of Cylinder Assembly

Cylinder model: CDJ2RA16-60Z-W-M9BW-B

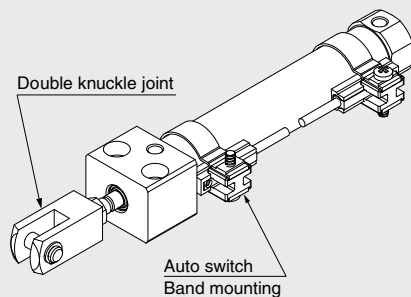

Mounting A: Bottom mounting
Rod end bracket W: Double knuckle joint
Auto switch D-M9BW: 2 pcs.
Auto switch mounting B: Band mounting

※: Double knuckle joint and auto switch are shipped together with the product, but not assembled.

Specifications

Bore size [mm]	10	16
Action	Double acting, Single rod	
Fluid	Air	
Proof pressure	1 MPa	
Maximum operating pressure	0.7 MPa	
Minimum operating pressure	0.06 MPa	
Ambient and fluid temperature	Without auto switch: -10°C to 70°C With auto switch: -10°C to 60°C (No freezing)	
Cushion	Rubber bumper	
Lubrication	Not required (Non-lube)	
Stroke length tolerance	+1.0 0	
Piston speed	50 to 750 mm/s	
Allowable kinetic energy	0.035 J	0.090 J

Standard Strokes

Bore size	Standard stroke	Maximum manufacturable stroke [mm]
10	15, 30, 45, 60, 75, 100, 125, 150	400
16	15, 30, 45, 60, 75, 100, 125, 150, 175, 200	400

※: Manufacture of intermediate strokes in 1 mm increments is possible. (Spacers are not used.)

※: Applicable strokes should be confirmed according to the usage. For details, refer to "Air Cylinders Model Selection" on front matter pages. In addition, the products that exceed the standard stroke might not be able to fulfill the specifications due to the deflection etc.

Accessories

/Refer to page 42 for the list of brackets and page 63 for details about part numbers and dimensions.

Standard	Rod end nut
Option ^{Note 1)}	Single knuckle joint, Double knuckle joint (including a pin and retaining rings), Rod end cap (Flat/Round type), Double knuckle joint (With one-touch connecting pin)

Note 1) Can be ordered within the cylinder model. Except for the double knuckle joint (with one-touch connecting pin).

Note 2) Stainless steel accessories are also available. Refer to page 63-1 for details.

Weights

Bore size [mm]	10	16	
Basic weight	Basic	36	61
	Axial piping	36	61
	Additional weight per 15 mm of stroke	4	7
Accessories	Single knuckle joint	17	23
	Double knuckle joint (including knuckle pin)	25	21
	Double knuckle joint (With one-touch connecting pin)	26	22
	Rod end cap (Flat type)	1	2
	Rod end cap (Round type)	1	2

※: Mounting nut and rod end nut are included in the basic weight.

Calculation:

Example) **CJ2RA10-45Z**

- Basic weight 36 (ø10)
 - Additional weight 4/15 stroke
 - Cylinder stroke 45 stroke
- $$36 + 4/15 \times 45 = 48 \text{ g}$$

Refer to pages 142 to 149 for cylinders with auto switches.

- Auto switch proper mounting position (detection at stroke end) and its mounting height
- Minimum stroke for auto switch mounting
- Operating range
- Auto switch mounting brackets/Part no.

Clean Series

10-CJ2RA $\frac{10}{16}$ - Stroke Head cover port location Z

• Clean Series

Air cylinder which is applicable for the system which discharges leakage from the rod section directly into the outside of clean room by relief port and making an actuator's rod section having a double seal construction.

For the detailed specifications, refer to the "Pneumatic Clean Series" (CAT.E02-23).

Specifications

Action	Double acting, Single rod
Bore size [mm]	10, 16
Maximum operating pressure	0.7 MPa
Minimum operating pressure	0.08 MPa
Cushion	Rubber bumper
Standard stroke [mm]	Same as standard type. (Refer to page 120.)
Auto switch	Mountable (Band mounting)
Mounting	Bottom mounting

CJ1

CJP

CJ2

JCM

CM2

CM3

CG1

CG3

JMB

MB

MB1

CA2

CS1

CS2

Construction (Not able to disassemble)

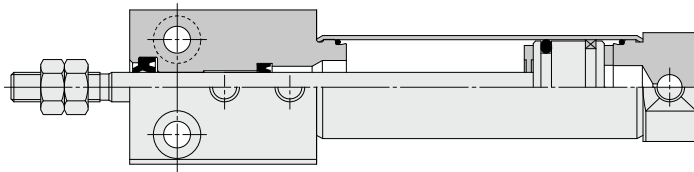

D-□

-X□

Technical Data

CJ2R Series

Construction (Not able to disassemble)

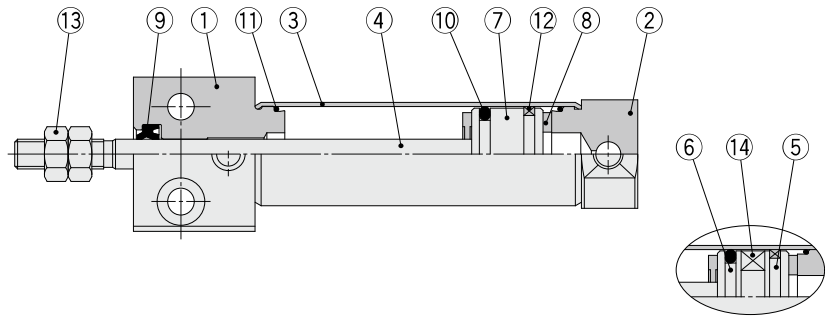

With auto switch

Component Parts

No.	Description	Material	Note
1	Rod cover	Aluminum alloy	
2	Head cover	Aluminum alloy	
3	Cylinder tube	Stainless steel	
4	Piston rod	Stainless steel	
5	Piston A	Aluminum alloy	
6	Piston B	Aluminum alloy	
7	Piston	Aluminum alloy	

No.	Description	Material	Note
8	Bumper	Urethane	
9	Rod seal	NBR	
10	Piston seal	NBR	
11	Tube gasket	NBR	
12	Wear ring	Resin	
13	Rod end nut	Rolled steel	
14	Magnet	—	

Bottom Mounting

CJ2RA $\frac{10}{16}$ – Stroke Head cover port location Z

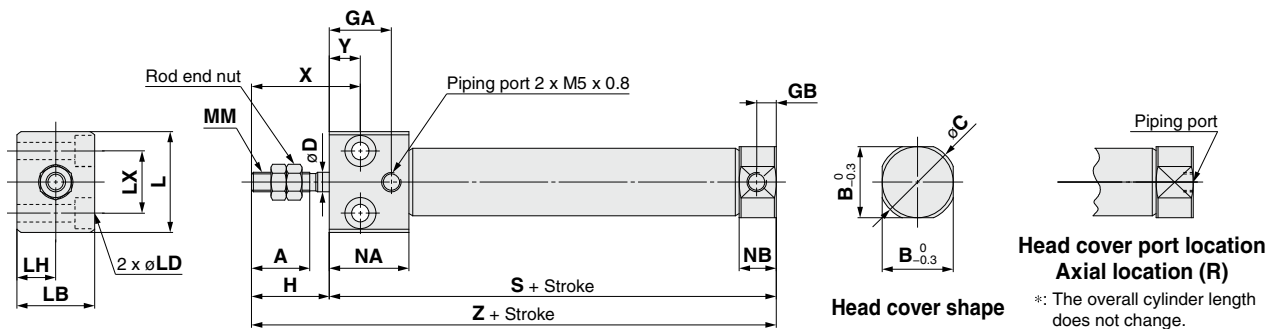

Bore size	[mm]																		
	A	B	C	D	GA	GB	H	L	LB	LD	LH	LX	MM	NA	NB	X	Y	S	Z
10	15	12	14	4	16	5	20	23	16	ø3.5 through, ø6.5 counterbore depth 4	8	12	M4 x 0.7	20.5	9.5	28	8	54	74
16	15	18.3	20	5	16	5	20	26	20	ø4.5 through, ø8 counterbore depth 5	10	16	M5 x 0.8	20.5	9.5	28	8	55	75

CJ2 Series

Dimensions of Accessories (Options)

Single Knuckle Joint

Material: Rolled steel

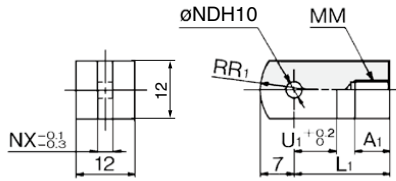

Double Knuckle Joint

Material: Rolled steel

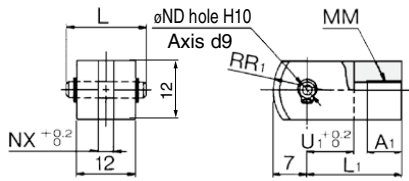

Knuckle Pin

Material: Stainless steel

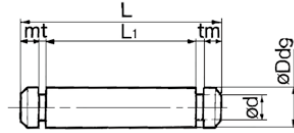

[mm]

Part no.	Applicable bore size	A ₁	L ₁	MM	NDH10	NX	R ₁	U ₁
I-J010C	10	8	21	M4 x 0.7	3.3 ^{+0.048} ₀	3.1	8	9
I-J016C	16	8	25	M5 x 0.8	5 ^{+0.048} ₀	6.4	12	14

[mm]

Part no.	Applicable bore size	A ₁	L	L ₁	MM
Y-J010C	10	8	15.2	21	M4 x 0.7
Y-J016C	16	11	16.6	21	M5 x 0.8

Part no.	NDd9	NDH10	NX	R ₁	U ₁
Y-J010C	3.3 ^{-0.030} _{-0.060}	3.3 ^{+0.048} ₀	3.2	8	10
Y-J016C	5 ^{-0.030} _{-0.060}	5 ^{+0.048} ₀	6.5	12	10

[mm]

Part no.	Applicable bore size	Dd9	d	L	L ₁	m	t	Included retaining ring
CD-J010	10	3.3 ^{-0.030} _{-0.060}	3	15.2	12.2	1.2	0.3	Type C 3.2
IY-J015	16	5 ^{-0.030} _{-0.060}	4.8	16.6	12.2	1.5	0.7	Type C 5

*: For ø10, a clevis pin is diverted.
 *: Retaining rings are included with a knuckle pin.

*: A knuckle pin and retaining rings are included.

Double Knuckle Joint (With One-touch Connecting Pin)

One-touch Connecting Pin for Double Knuckle Joint

Material: Stainless steel

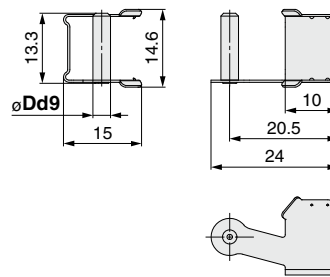
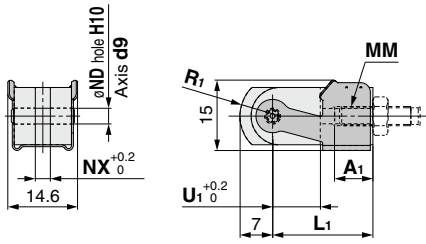

[mm]

Part no.	Applicable bore size	A ₁	L ₁	MM	NDd9	NDH10	NX	R ₁	U ₁
Y-J10	10	8	21	M4 x 0.7	3.3 ^{-0.030} _{-0.060}	3.3 ^{+0.048} ₀	3.2	8	10
Y-J16	16	11	21	M5 x 0.8	5 ^{-0.030} _{-0.060}	5 ^{+0.048} ₀	6.5	12	10

[mm]

Part no.	Applicable bore size	Dd9
IY-J10	10	3.3 ^{-0.030} _{-0.060}
IY-J16	16	5 ^{-0.030} _{-0.060}

Mounting Nut

Material: Carbon steel

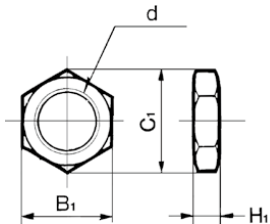

Rod End Nut

Material: Carbon steel

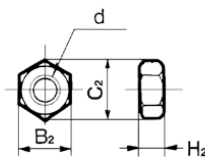

[mm]

Part no.	Applicable bore size	B ₁	C ₁	d	H ₁
SNJ-006C	6	8	9.2	M6 x 1.0	4
SNJ-010C	10	11	12.7	M8 x 1.0	4
SNJ-016C	16	14	16.2	M10 x 1.0	4
SNKJ-016C*	16	17	19.6	M12 x 1.0	4

[mm]

Part no.	Applicable bore size	B ₂	C ₂	d	H ₂
NTJ-006B	6	5.5	6.4	M3 x 0.5	2.4
NTJ-010C	10	7	8.1	M4 x 0.7	3.2
NTJ-015C	16	8	9.2	M5 x 0.8	4

*: For ø16 non-rotating type. (Use SNJ-016C for ø10 non-rotating type.)

CJ1

CJP

CJ2

JCM

CM2

CM3

CG1

CG3

JMB

MB

MB1

CA2

CS1

CS2

D-□

-X□

Technical Data

Pivot Bracket (T-bracket)

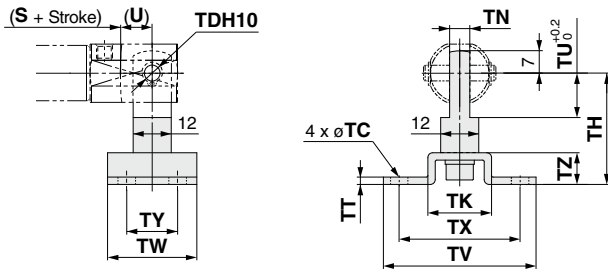

Part no.	Applicable bore size	TC	TDH10	TH	TK	TN	TT	TU	TV	TW	TX	TY	TZ
CJ-T010C	10	4.5	3.3 ^{+0.048} ₀	29	18	3.1	2	9	40	22	32	12	8
CJ-T016C	16	5.5	5 ^{+0.048} ₀	35	20	6.4	2.3	14	48	28	38	16	10

*: A T-bracket includes a T-bracket base, single knuckle joint, hexagon socket head bolt and spring washer.

*: For dimensions of (U) and (S + Stroke), refer to the double clevis drawing on page 60.

Clevis Pin

Material: Stainless steel

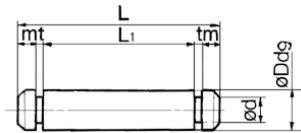

Part no.	Applicable bore size	Dd9	d	L	L ₁	m	t	Included retaining ring
CD-J010	10	3.3 ^{-0.030} _{-0.060}	3	15.2	12.2	1.2	0.3	Type C 3.2
CD-Z015	16	5 ^{-0.030} _{-0.060}	4.8	22.7	18.3	1.5	0.7	Type C 5
CD-JA010*	10	3.3 ^{-0.030} _{-0.060}	3	18.2	15.2	1.2	0.3	Type C 3.2

*: For ø10 double clevis type, with air cushion and built-in speed controller.

*: Retaining rings are included with a clevis pin.

One-touch Connecting Pin for Double Clevis

Material: Stainless steel

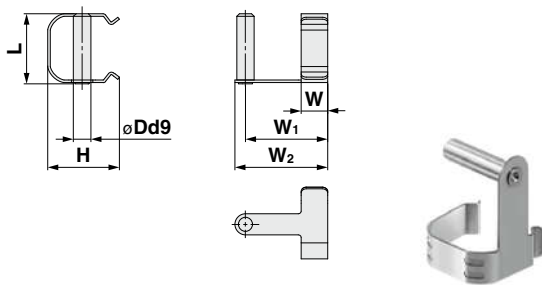

Part no.	Applicable bore size	Dd9	H	L	W
CD-J10	10	3.3 ^{-0.030} _{-0.060}	13.4	13.2	4
CD-J16	16	5 ^{-0.030} _{-0.060}	18.2	19.5	5

Part no.	W ₁	W ₂	Note
CD-J10	12	15	Cannot be mounted on cylinders with air cushion, or rail mounting type auto switches.
CD-J16	15	18	

*: Please pay attention to the applicable cylinder.

Rod End Cap

Material: Polyacetal

Flat type/CJ-CF□□□

Round type/CJ-CR□□□

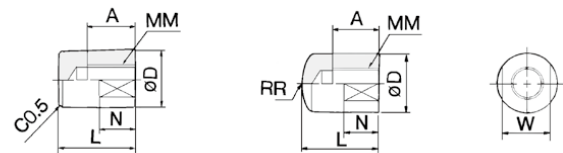

Part no.		Applicable bore size	A	D	L	MM	N	R	W
Flat type	Round type								
CJ-CF006	CJ-CR006	6	6	8	11	M3 x 0.5	5	8	6
CJ-CF010	CJ-CR010	10	8	10	13	M4 x 0.7	6	10	8
CJ-CF016	CJ-CR016	16	10	12	15	M5 x 0.8	7	12	10

Mounting Brackets, Rod End Brackets, and Nut Material: Stainless Steel

Part No. (Dimensions: Same as standard type)

Bore size [mm]	Foot	Flange	Single knuckle joint	Double knuckle joint*	Mounting nut	Rod end nut
10	—	—	I-J010SUS	Y-J010SUS	—	NTJ-010SUS
16	CJ-L016SUS	CJ-F016SUS	I-J016SUS	Y-J016SUS	SNJ-016SUS	NTJ-015SUS

*: A knuckle pin and retaining rings are shipped together.

Precautions

Assembly Procedures

1. Double Clevis (With One-touch Connecting Pin) (CD-J□)

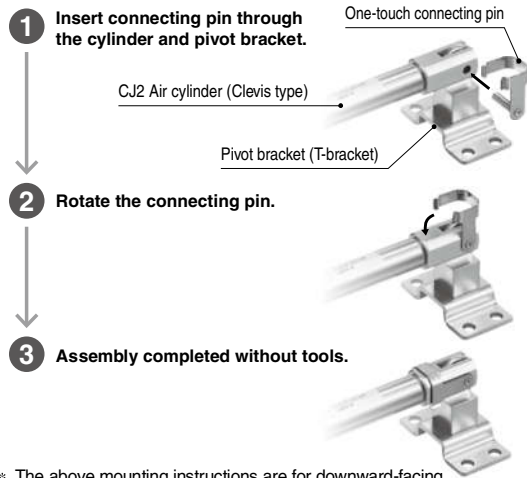

* The above mounting instructions are for downward-facing ports. Refer to the following for upward-facing ports.

2. Double Knuckle Joint (With One-touch Connecting Pin) (IY-J□)

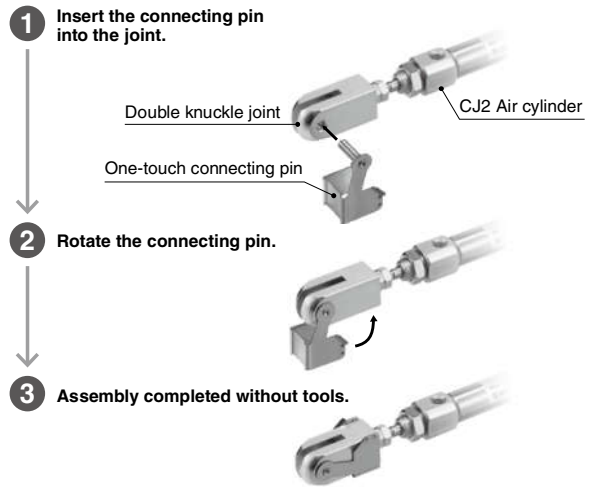

CJ1

CJP

CJ2

JCM

CM2

CM3

CG1

CG3

JMB

MB

MB1

CA2

CS1

CS2

How to Mount the Double Clevis (With One-touch Connecting Pin)

When connecting a double clevis cylinder to a pivot bracket (T-bracket), it is recommended that the pivot bracket (T-bracket) and the cylinder be connected with the one-touch connecting pin first, before fastening the pivot bracket.

When connecting the cylinder after the pivot bracket (T-bracket) has been fastened, mount the cylinder according to the following procedure.

⚠ Warning

For assembling the clevis type to the pivot bracket, refer to the figure below.

1. Insert the double clevis (One-touch connecting pin) from the direction in the figure.

When port is facing upward

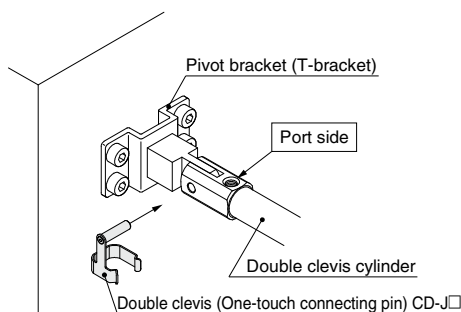

When port is facing downward

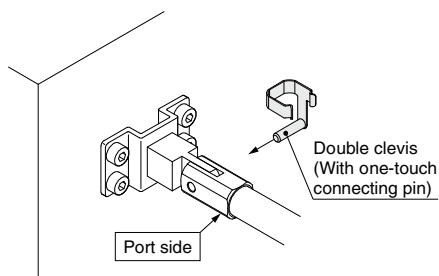

⚠ Warning

* Perform the mounting within the following range.

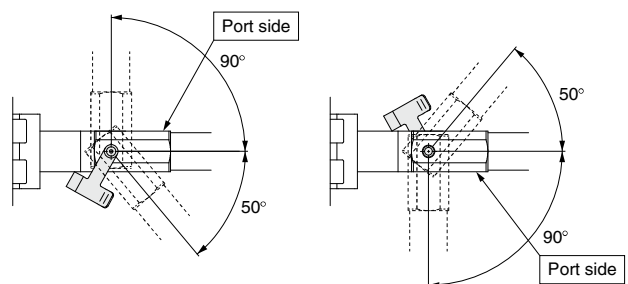

2. Push the one-touch connecting pin into the cylinder body (Double clevis) until it clicks and is firmly fastened.

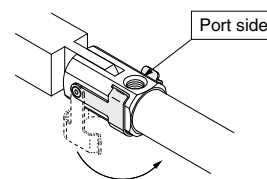

* Attach the double knuckle joint within 180° (±90° from center). Other mounting methods are the same as the above.

D-□

-X□

Technical Data

CJ2 Series

Auto Switch Mounting

Auto Switch Proper Mounting Position (Detection at stroke end) and Its Mounting Height

Solid state auto switch

<Band mounting>

D-M9□

D-M9□W

D-M9□A

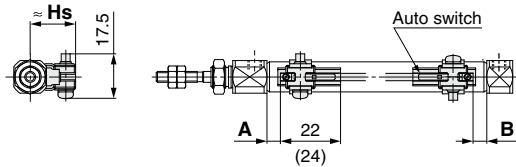

(): Dimension of the D-M9□A.
A and B are the dimensions from the end of the head cover/rod cover to the end of the auto switch.

D-M9□V

D-M9□MV

D-M9□AV

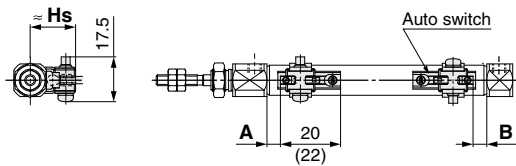

(): Dimension of the D-M9□AV.
A and B are the dimensions from the end of the head cover/rod cover to the end of the auto switch.

D-H7□

D-H7□W

D-H7BA

D-H7NF

D-H7C

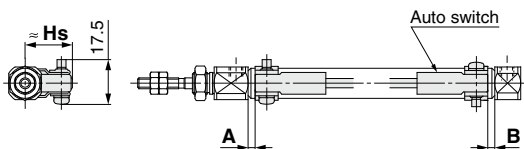

Reed auto switch

<Band mounting>

D-A9□

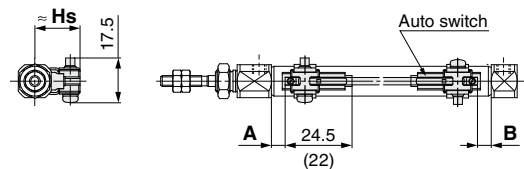

(): Dimension of the D-A96.
A and B are the dimensions from the end of the head cover/rod cover to the end of the auto switch.

D-A9□V

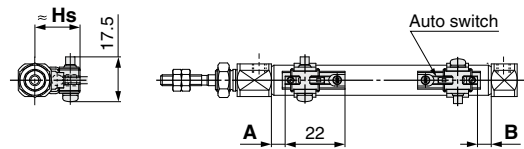

A and B are the dimensions from the end of the head cover/rod cover to the end of the auto switch.

D-C7□/C80

D-C73C□/C80C

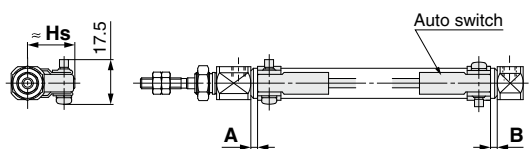

Auto Switch Proper Mounting Position (Detection at stroke end) and Its Mounting Height

<Rail mounting>

D-M9□
D-M9□W
D-M9□A

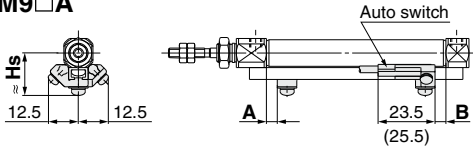

() : Dimension of the D-M9□A.

D-M9□V
D-M9□WV
D-M9□AV

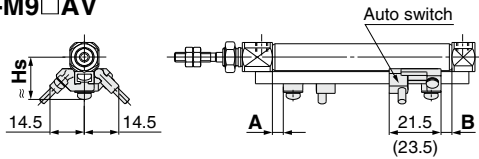

() : Dimension of the D-M9□AV.

D-F7□/J79
D-F7□W/J79W
D-F79F/F7BA

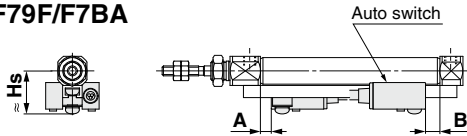

D-F7□V/F7□WV
D-F7BAV
D-J79C

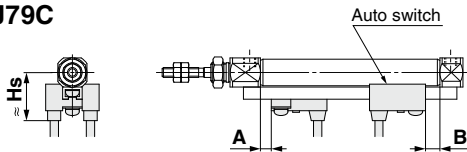

<Rail mounting>

D-A9□

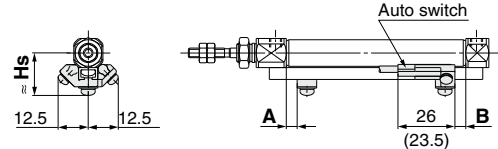

() : Dimension of the D-A96.

D-A9□V

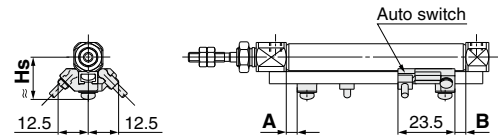

D-A7□/A80
D-A73C/A80C
D-A79W

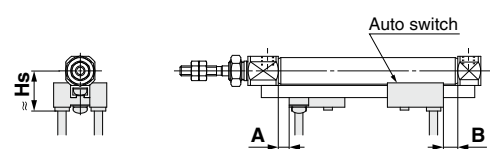

D-A7□H/A80H

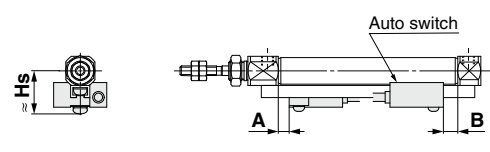

- CJ1
- CJP
- CJ2
- JCM
- CM2
- CM3
- CG1
- CG3
- JMB
- MB
- MB1
- CA2
- CS1
- CS2

- D-□
- X□
- Technical Data

Auto Switch Proper Mounting Position (Detection at stroke end) and Its Mounting Height

Auto Switch Proper Mounting Position (Single acting type excluded) [mm]

Auto switch model	Band mounting							
	D-M9□ D-M9□V D-M9□W D-M9□WV D-M9□A D-M9□AV		D-A9□ D-A9□V		D-H7□ D-H7C D-H7NF D-H7□W D-H7BA		D-C7□ D-C80 D-C73C D-C80C	
Bore size	A	B	A	B	A	B	A	B
6	5.5 (4.5) [12]	5.5 (4.5) [4]	1.5 (0.5) [8]	1.5 (0.5) [0]	1 (7.5)	1 (0)	2 (8.5)	2 (0.5)
10	(5) 6	(5) 6	(1) 2	(1) 2	1.5	1.5	2.5	2.5
16	(5.5) 6.5	(5.5) 6.5	(1.5) 2.5	(1.5) 2.5	2	2	3	3

※: The values in () are measured from the end of the auto switch mounting bracket.

※: The values in [] for bore size ø6 are for the double rod type (CJ2W series).

Auto Switch Proper Mounting Position (Rail mounting) [mm]

Auto switch model	Rail mounting											
	D-M9□ D-M9□V D-M9□W D-M9□WV D-M9□A D-M9□AV		D-A9□ D-A9□V		D-F7□/J79 D-F7□W/J79W D-F7□V/F7□WV D-F79F D-J79C D-F7BA D-F7BAV D-A7□H/A80H D-A73C/A80C		D-F7NT		D-A7□ D-A80		D-A79W	
Bore size	A	B	A	B	A	B	A	B	A	B	A	B
6	—	—	—	—	—	—	—	—	—	—	—	—
10	4.5	4.5	0.5	0.5	3.5	3.5	8.5	8.5	3	3	0.5	0.5
16	5	5	1	1	4	4	9	9	3.5	3.5	1	1

※: Adjust the auto switch after confirming the operating condition in the actual setting.

Auto Switch Mounting Height [mm]

Auto switch model	Band mounting							
	D-M9□ D-M9□W D-M9□A D-A9□		D-M9□V D-M9□WV D-M9□AV D-A9□V		D-H7□/H7□W D-H7NF D-H7BA D-C7□/C80		D-H7C	D-C73C D-C80C
Bore size	Hs		Hs		Hs		Hs	Hs
6	15		16		15		18	17.5
10	17		18		17		20	19.5
16	20.5		21		20.5		23.5	23

Auto Switch Mounting Height (Rail mounting) [mm]

Auto switch model	Rail mounting									
	D-M9□ D-M9□V D-M9□W D-M9□WV D-M9□A D-M9□AV D-A9□ D-A9□V		D-F7□/J79 D-F7□W/J79W D-F7BA/F79F D-F7NT D-A7□H/A80H		D-F7□V D-F7□WV D-F7BAV		D-J79C	D-A7□ D-A80	D-A73C D-A80C	D-A79W
Bore size	Hs		Hs		Hs		Hs	Hs	Hs	Hs
6	—		—		—		—	—	—	—
10	17.5		17.5		20		23	16.5	23.5	19
16	21		20.5		23		26	19.5	26.5	22

**Auto Switch Proper Mounting Position (Detection at stroke end)
and Its Mounting Height/Single Acting, Spring Return Type (S)**

Auto Switch Proper Mounting Position: Spring Return Type (S)

- Standard Type (CDJ2□□□-□SZ)
- Non-rotating Rod Type (CDJ2K□□□-□SZ)
- Direct Mount Type (CDJ2R□□□-□SZ)
- Direct Mount, Non-rotating Rod Type (CDJ2RK□□□-□SZ)

Auto switch model	Bore size	A dimensions										B	
		5 to 9 st	10 to 15 st	16 to 30 st	31 to 45 st	46 to 60 st	61 to 75 st	76 to 100 st	101 to 125 st	126 to 150 st			
Band mounting	D-M9□	6	—	12	21	25	39	—	—	—	—	5.5	
	D-M9□W/M9□WV D-M9□A/M9□AV	10	—	13	20.5	32.5	44.5	—	—	—	—	6	
		16	—	12.5	21	33	45	51	75	93	105	6.5	
	D-M9□V	6	12	12	21	25	39	—	—	—	—	5.5	
		10	13	13	20.5	32.5	44.5	—	—	—	—	6	
		16	12.5	12.5	21	33	45	51	75	93	105	6.5	
	D-A9□	6	—	8	17	21	35	—	—	—	—	1.5	
		10	—	9	16.5	28.5	40.5	—	—	—	—	2	
		16	—	8.5	17	29	41	47	71	89	101	2.5	
	D-A9□V	6	8	8	17	21	35	—	—	—	—	1.5	
		10	9	9	16.5	28.5	40.5	—	—	—	—	2	
		16	8.5	8.5	17	29	41	47	71	89	101	2.5	
	D-H7□/H7C D-H7□W/H7BA D-H7NF	6	—	7.5	16.5	20.5	34.5	—	—	—	—	1	
		10	—	8.5	16	28	40	—	—	—	—	1.5	
		16	—	8	16.5	28.5	40.5	46.5	70.5	88.5	100.5	2	
	D-C7□/C80 D-C73C D-C80C	6	—	8.5	17.5	21.5	35.5	—	—	—	—	2	
		10	—	9.5	17	29	41	—	—	—	—	2.5	
		16	—	9	17.5	29.5	41.5	47.5	71.5	89.5	101.5	3	
	Rail mounting	D-M9□ D-M9□W/M9□WV D-M9□A/M9□AV	10	—	11.5	19	31	43	—	—	—	—	4.5
			16	—	11	19.5	31.5	43.5	49.5	73.5	91.5	103.5	5
			10	11.5	11.5	19	31	43	—	—	—	—	4.5
		D-M9□V	16	11	11	19.5	31.5	43.5	49.5	73.5	91.5	103.5	5
			10	—	7.5	15	27	39	—	—	—	—	0.5
		D-A9□	16	—	7	15.5	27.5	39.5	45.5	69.5	87.5	99.5	1
10			7.5	7.5	15	27	39	—	—	—	—	0.5	
D-A9□V		16	7	7	15.5	27.5	39.5	45.5	69.5	87.5	99.5	1	
		10	10.5	10.5	18	30	42	—	—	—	—	3.5	
D-F7□/F7□V D-J79/J79C D-A7□H/A80H D-A73C/A80C		16	10	10	18.5	30.5	42.5	48.5	72.5	90.5	102.5	4	
		10	—	10.5	18	30	42	—	—	—	—	3.5	
D-F7□W/J79W D-F7□WV/F79F D-F7BA/F7BAV		16	—	10	18.5	30.5	42.5	48.5	72.5	90.5	102.5	4	
		10	—	15.5	23	35	47	—	—	—	—	8.5	
D-F7NT		16	—	15	23.5	35.5	47.5	53.5	77.5	95.5	107.5	9	
		10	10	10	17.5	29.5	41.5	—	—	—	—	3	
D-A7□/A80		16	9.5	9.5	18	30	42	48	72	90	102	3.5	
		10	—	7.5	15	27	39	—	—	—	—	0.5	
D-A79W		16	—	7	15.5	27.5	39.5	45.5	69.5	87.5	99.5	1	

※: In the actual setting, adjust them after confirming the auto switch performance.

- CJ1
- CJP
- CJ2**
- JCM
- CM2
- CM3
- CG1
- CG3
- JMB
- MB
- MB1
- CA2
- CS1
- CS2

- D-□
- X□
- Technical Data

CJ2 Series

Auto Switch Proper Mounting Position (Detection at stroke end) and Its Mounting Height/Single Acting, Spring Extend Type (T)

Auto Switch Proper Mounting Position: Spring Extend Type (T)

- Standard Type (CDJ2□□□-□TZ)
- Non-rotating Rod Type (CDJ2K□□□-□TZ)
- Direct Mount Type (CDJ2R□□□-□TZ)
- Direct Mount, Non-rotating Rod Type (CDJ2RK□□□-□TZ)

[mm]

Auto switch model	Bore size	A	B dimensions										
			5 to 9 st	10 to 15 st	16 to 30 st	31 to 45 st	46 to 60 st	61 to 75 st	76 to 100 st	101 to 125 st	126 to 150 st		
Band mounting	D-M9□ D-M9□W/M9□WV D-M9□A/M9□AV	6	5.5	—	12	21	25	39	—	—	—	—	
		10	6	—	13	20.5	32.5	44.5	—	—	—	—	
		16	6.5	—	12.5	21	33	45	51	75	93	105	
	D-M9□V	6	5.5	12	12	21	25	39	—	—	—	—	
		10	6	13	13	20.5	32.5	44.5	—	—	—	—	
		16	6.5	12.5	12.5	21	33	45	51	75	93	105	
	D-A9□	6	1.5	—	8	17	21	35	—	—	—	—	
		10	2	—	9	16.5	28.5	40.5	—	—	—	—	
		16	2.5	—	8.5	17	29	41	47	71	89	101	
	D-A9□V	6	1.5	8	8	17	21	35	—	—	—	—	
		10	2	9	9	16.5	28.5	40.5	—	—	—	—	
		16	2.5	8.5	8.5	17	29	41	47	71	89	101	
	D-H7□/H7C D-H7□W/H7BA D-H7NF	6	1	—	7.5	16.5	20.5	34.5	—	—	—	—	
		10	1.5	—	8.5	16	28	40	—	—	—	—	
		16	2	—	8	16.5	28.5	40.5	46.5	70.5	88.5	100.5	
	D-C7□/C80 D-C73C D-C80C	6	2	—	8.5	17.5	21.5	35.5	—	—	—	—	
		10	2.5	—	9.5	17	29	41	—	—	—	—	
		16	3	—	9	17.5	29.5	41.5	47.5	71.5	89.5	101.5	
	Rail mounting	D-M9□ D-M9□W/M9□WV D-M9□A/M9□AV	10	4.5	—	11.5	19	31	43	—	—	—	—
			16	5	—	11	19.5	31.5	43.5	49.5	73.5	91.5	103.5
			10	4.5	11.5	11.5	19	31	43	—	—	—	—
		D-M9□V	16	5	11	11	19.5	31.5	43.5	49.5	73.5	91.5	103.5
			10	0.5	—	7.5	15	27	39	—	—	—	—
		D-A9□	16	1	—	7	15.5	27.5	39.5	45.5	69.5	87.5	99.5
10			0.5	7.5	7.5	15	27	39	—	—	—	—	
D-A9□V		16	1	7	7	15.5	27.5	39.5	45.5	69.5	87.5	99.5	
		10	3.5	10.5	10.5	18	30	42	—	—	—	—	
D-F7□/F7□V D-J79/J79C D-A7□H/A80H D-A73C/A80C		16	4	10	10	18.5	30.5	42.5	48.5	72.5	90.5	102.5	
		10	3.5	—	10.5	18	30	42	—	—	—	—	
D-F7□W/J79W D-F7□WV/F79F D-F7BA/F7BAV		16	4	—	10	18.5	30.5	42.5	48.5	72.5	90.5	102.5	
		10	8.5	—	15.5	23	35	47	—	—	—	—	
D-F7NT		16	9	—	15	23.5	35.5	47.5	53.5	77.5	95.5	107.5	
		10	3	10	10	17.5	29.5	41.5	—	—	—	—	
D-A7□/A80		16	3.5	9.5	9.5	18	30	42	48	72	90	102	
		10	0.5	—	7.5	15	27	39	—	—	—	—	
D-A79W		16	1	—	7	15.5	27.5	39.5	45.5	69.5	87.5	99.5	

※: In the actual setting, adjust them after confirming the auto switch performance.

Minimum Stroke for Auto Switch Mounting

[mm]

Auto switch mounting	Auto switch model	Number of auto switches				
		With 1 pc.	With 2 pcs.		With n pcs. (n: Number of auto switches)	
			Different surfaces	Same surface	Different surfaces	Same surface
Band mounting	D-M9□ D-M9□W D-M9□A D-A9□	10	15*1	45*1	$15 + 35 \frac{(n-2)}{2}$ (n = 2, 4, 6...)*3	45 + 15 (n - 2) (n = 2, 3, 4, 5...)
	D-M9□V	5	15*1	35	$15 + 35 \frac{(n-2)}{2}$ (n = 2, 4, 6...)*3	35 + 25 (n - 2) (n = 2, 3, 4, 5...)
	D-M9□WV D-M9□AV	10	15*1	35	$15 + 35 \frac{(n-2)}{2}$ (n = 2, 4, 6...)*3	35 + 25 (n - 2) (n = 2, 3, 4, 5...)
	D-A9□V	5	10	35	$10 + 35 \frac{(n-2)}{2}$ (n = 2, 4, 6...)*3	35 + 25 (n - 2) (n = 2, 3, 4, 5...)
	D-H7□/H7□W D-H7BA D-H7NF	10	15	60	$15 + 45 \frac{(n-2)}{2}$ (n = 2, 4, 6...)*3	60 + 22.5 (n - 2) (n = 2, 3, 4, 5...)
	D-C7□ D-C80	10	15	50	$15 + 40 \frac{(n-2)}{2}$ (n = 2, 4, 6...)*3	50 + 20 (n - 2) (n = 2, 3, 4, 5...)
	D-H7C D-C73C D-C80C	10	15	65	$15 + 50 \frac{(n-2)}{2}$ (n = 2, 4, 6...)*3	50 + 27.5 (n - 2) (n = 2, 3, 4, 5...)
Rail mounting	D-M9□V	5	—	5	—	10 + 10 (n - 2) (n = 4, 6...)*4
	D-A9□V	5	—	10	—	10 + 15 (n - 2) (n = 4, 6...)*4
	D-M9□ D-A9□	10 (5)*5	—	10	—	15 + 15 (n - 2) (n = 4, 6...)*4
	D-M9□WV D-M9□AV	10	—	15	—	15 + 15 (n - 2) (n = 4, 6...)*4
	D-M9□W	15 (10)*5	—	15	—	20 + 15 (n - 2) (n = 4, 6...)*4
	D-M9□A	15 (10)*5	—	20 (15)*5	—	20 + 15 (n - 2) (n = 4, 6...)*4
	D-F7□ D-J79	5	—	5	—	15 + 15 (n - 2) (n = 4, 6...)*4
	D-F7□V D-J79C	5	—	5	—	10 + 10 (n - 2) (n = 4, 6...)*4
	D-F7□W/J79W D-F7BA/F79F/F7NT	10	—	15	—	15 + 20 (n - 2) (n = 4, 6...)*4
	D-F7□WV D-F7BAV	10	—	15	—	10 + 15 (n - 2) (n = 4, 6...)*4
	D-A7□/A80 D-A7□H/A80H D-A73C/A80C	5	—	10	—	15 + 10 (n - 2) (n = 4, 6...)*4
	D-A7□H D-A80H	5	—	10	—	15 + 15 (n - 2) (n = 4, 6...)*4
	D-A79W	10	—	15	—	10 + 15 (n - 2) (n = 4, 6...)*4

- *3: When "n" is an odd number, an even number that is one larger than this odd number is used for the calculation.
- *4: When "n" is an odd number, an even number that is one larger than this odd number is used for the calculation. However, the minimum even number is 4. So, 4 is used for the calculation when "n" is 1 to 3.
- *5: The dimension stated in () shows the minimum mountable stroke when the auto switch does not project from the end face of the cylinder body and the lead wire bending space is not hindered.

*1: Auto switch mounting

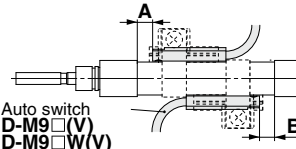
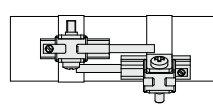
Auto switch model	With 2 auto switches	
	Different surfaces*1	Same surface*1
 <p>Auto switch D-M9□(V) D-M9□W(V) D-M9□A(V)</p> <p>The proper auto switch mounting position is 5.5 mm inward from the switch holder edge. The above A and B indicate values for band mounting in the table of page 144.</p>	 <p>The auto switch is mounted by slightly displacing it in a direction (cylinder tube circumferential exterior) so that the auto switch and lead wire do not interfere with each other.</p>	
D-M9□/M9□W/M9□A	Less than 20 stroke*2	Less than 55 stroke*2
D-A9□	—	Less than 50 stroke*2

*2: Minimum stroke for auto switch mounting in types other than those mentioned in *1.

CJ1

CJP

CJ2

JCM

CM2

CM3

CG1

CG3

JMB

MB

MB1

CA2

CS1

CS2

D-□

-X□

Technical Data

Operating Range

Auto switch model		Bore size [mm]			
		6	10	16	
Band mounting	D-M9□/M9□V D-M9□W/M9□WV D-M9□A/M9□AV	2	2.5	3	
	D-A9□	4.5	6	7	
	D-H7□/H7□W D-H7BA/H7NF	3	4	4	
	D-H7C	5	8	9	
	D-C7□/C80/C73C/C80C	6	7	7	
	Rail mounting	D-M9□/M9□V D-M9□W/M9□WV D-M9□A/M9□AV	—	3	3.5
		D-A9□/A9□V	—	6	6.5
D-F7□/J79/F7□W/J79W D-F7□V/F7□WV/F79F D-J79C/F7BA/F7BAV D-F7NT		—	5	5	
D-A7□/A80/A7H/A80H D-A73C/A80C		—	8	9	
D-A79W		—	11	13	

*: Values which include hysteresis are for guideline purposes only, they are not a guarantee (assuming approximately ±30% dispersion) and may change substantially depending on the ambient environment.

Auto Switch Mounting Brackets/Part No.

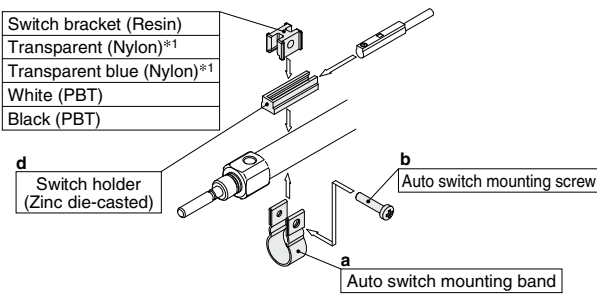
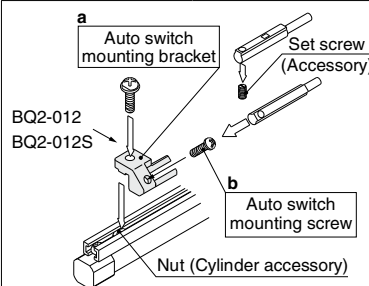
Auto switch mounting	Auto switch model	Bore size [mm]		
		6	10	16
Band mounting	D-M9□ D-M9□V D-M9□W D-M9□WV D-A9□ D-A9□V	BJ6-006 (A set of a, b, d, f)	BJ6-010 (A set of a, b, c, d)	BJ6-016 (A set of a, b, c, d)
	D-M9□A*2 D-M9□AV*2	BJ6-006S (A set of a, b, d, g)	BJ6-010S (A set of a, b, d, e)	BJ6-016S (A set of a, b, d, e)
Band mounting				
		D-H7□/H7□W D-H7BA/H7NF D-C7□/C80 D-C73C/C80C	BJ2-006 (A set of band and screw)	BJ2-010 (A set of band and screw)
Rail mounting	*4 D-M9□ D-M9□V D-M9□W D-M9□WV D-M9□A*4 D-M9□AV*4 D-A9□ D-A9□V	—	BQ2-012 (S) (A set of a and b)	BQ2-012 (S) (A set of a and b)
				

*1: Since the switch bracket (made from nylon) are affected in an environment where alcohol, chloroform, methylamines, hydrochloric acid or sulfuric acid is splashed over, so it cannot be used. Please contact SMC regarding other chemicals.

*2: As the indicator LED is projected from the auto switch unit, indicator LED may be damaged if the switch bracket is fixed on the indicator LED.

*3: When the cylinder is shipped, the auto switch mounting bracket and the auto switch will be included.

*4: For D-M9□A(V), order the BQ2-012S, which uses stainless steel mounting screws.

Band Mounting Brackets Set Part No.

Set part no.	Contents	Bore size [mm]		
		6	10	16
BJ2-□□□	• Auto switch mounting band (a) • Auto switch mounting screw (b)	BJ2-006	BJ2-010	BJ2-016
BJ4-1	• Switch bracket (White/PBT) (e) • Switch holder (d)	—	●	●
BJ4-2	• Switch bracket (Black/PBT) (g) • Switch holder (d)	●	—	—
BJ5-1	• Switch bracket (Transparent/Nylon) (c)*1 • Switch holder (d)	—	●	●
BJ5-2	• Switch bracket (Transparent blue/Nylon) (f)*1 • Switch holder (d)	●	—	—

[Stainless Steel Mounting Screw]

The following stainless steel mounting screw kit is available. Use it in accordance with the operating environment. (Since the auto switch mounting bracket is not included, order it separately.)

BBA4: For D-C7/C8/H7 types

*5: Refer to page 1682 for details on the BBA4.

When the D-H7BA type auto switch is shipped independently, the BBA4 is attached.

Other than the applicable auto switches listed in “How to Order”, the following auto switches are mountable.

Refer to pages 1575 to 1701 for the detailed specifications.

Type	Mounting	Model	Electrical entry	Features	Applicable bore size	
Sold state	Band mounting	D-H7A1/H7A2/H7B	Grommet (In-line)	—	ø6 to ø16	
		D-H7NW/H7PW/H7BW		Diagnostic indication (2-color indicator)		
	Rail mounting	D-F79/F7P/J79		Grommet (Perpendicular)	—	ø10, ø16
		D-F79W/F7PW/J79W			Diagnostic indication (2-color indicator)	
		D-F7NV/F7PV/F7BV	Grommet (Perpendicular)	—		
		D-F7NWV/F7BWV		Diagnostic indication (2-color indicator)		
Reed	Band mounting	D-C73/C76	Grommet (In-line)	—	ø6 to ø16	
		D-C80		Without indicator light		
	Rail mounting	D-A73H/A76H		Grommet (Perpendicular)	—	ø10, ø16
		D-A80H			Without indicator light	
		D-A73	Grommet (Perpendicular)	—		
		D-A80		Without indicator light		

*: With pre-wired connector is also available for solid state auto switches. For details, refer to pages 1648 and 1649.

*: Normally closed (NC = b contact) solid state auto switches (D-F9G/F9H) are also available. For details, refer to page 1593.

CJ1

CJP

CJ2

JCM

CM2

CM3

CG1

CG3

JMB

MB

MB1

CA2

CS1

CS2

D-□

-X□

Technical Data

CJ2 Series

Made to Order: Individual Specifications

Contact SMC for detailed specifications, delivery and prices.



1 PTFE Grease

Symbol
-X446

Applicable Series

Description	Model	Action	Note
Standard type	CJ2	Double acting, Single rod	
		Single acting (Spring return/extend)	
	CJ2W	Double acting, Double rod	
Non-rotating rod type	CJ2K	Double acting, Single rod	
		Single acting (Spring return/extend)	
Built-in speed controller type	CJ2Z	Double acting, Single rod	
		CJ2ZW	Double acting, Double rod
Direct mount type	CJ2R	Double acting, Single rod	
		Single acting (Spring return/extend)	
Direct mount, Non-rotating rod type	CJ2RK	Double acting, Single rod	
		Single acting (Spring return/extend)	

Specifications: Same as standard type

Dimensions: Same as standard type

※: When grease is necessary for maintenance, grease pack is available, please order it separately.
GR-F-005 (Grease: 5 g)

How to Order

Standard model no. **- X446**
PTFE grease ●

Warning Precautions

Be aware that smoking cigarettes etc. after your hands have come into contact with the grease used in this cylinder can create a gas that is hazardous to humans.

2 Short Pitch Mounting/Single Acting, Spring Return

Symbol
-X773

Mounting pitch is shortened when cylinders are used in parallel.

- Changes rod cover and head cover dimensions to $\phi 7$.
- Shortens the full length with a head cover integrated with a barb fitting.

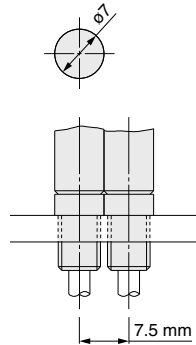

*: Directly mounted with cylinder mounting screws

Application example

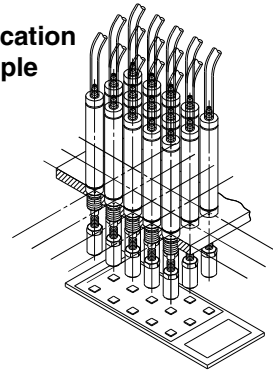

Verification of push button actuation for mobile phones etc.

Applicable Series

Description	Model	Action	Note
Standard type	CJ2	Single acting (Spring return)	

How to Order

CJ2B6 - **Stroke** SU4Z - X773

- Short pitch mounting/
Single acting, spring return



Specifications

Bore size [mm]	6
Action	Single acting, Spring return
Operating pressure range	0.2 to 0.7 MPa
Port size	With $\phi 4$ barb fitting (For soft tube)
Connecting port location	Head cover/Axial direction
Stroke [mm]	5 to 60
Auto switch	None

Dimensions

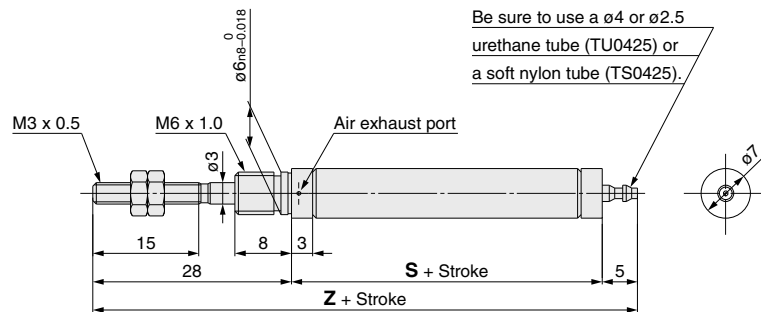

	[mm]			
Stroke	5 to 15	16 to 30	31 to 45	46 to 60
S	30.5	39.5	43.5	57.5
Z	63.5	72.5	76.5	90.5

Note

1. When mounting a cylinder, make sure that the air exhaust port on the rod cover is not blocked.
2. When mounting a cylinder, apply thread locking adhesive on the threaded part and hold the external diameter of the rod cover with a needle-nose pliers or regular pliers.

CJ1

CJP

CJ2

JCM

CM2

CM3

CG1

CG3

JMB

MB

MB1

CA2

CS1

CS2

D-□

-X□

Technical
Data

3 Double Clevis (With One-touch Connecting Pin)

With pivot bracket (T-bracket) and one-touch connecting pin
Not necessary to order a bracket for the applicable cylinder separately.

Applicable Series

Applicable Cylinders (Double Clevis Type)

Series	Bore size [mm]	Type	Model	Action	Note
CJ2D	10, 16	Standard	CJ2D	Double acting, Single rod	Cannot be mounted on cylinders with air cushion, or rail mounting type auto switches.
			CJ2D	Single acting, Single rod (Spring return/extend)	
		Non-rotating rod type	CJ2KD	Double acting, Single rod	
			CJ2KD	Single acting, Single rod (Spring return/extend)	

How to Order

Example) **CDJ2D10-60Z-N-M9BW-B-X2838**

- **With one-touch connecting pin**
- **Pivot bracket (T-bracket)**
- **Double clevis type**

Nil	None
N	Pivot bracket is shipped together with the product, but not assembled.

*: The pivot bracket (T-bracket) and one-touch connecting pin are shipped together. Refer to page 63-2 for assembly instructions.

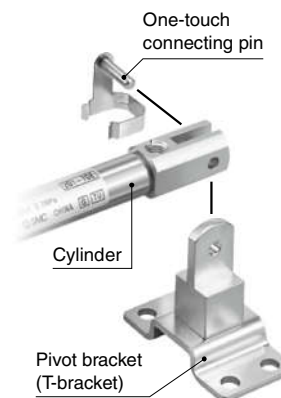

Specifications: Same as standard type

Dimensions

CJ2D $\frac{10}{16}$ - Stroke Z - (N) - X2838

*: Refer to page 63-2 for assembly procedures and mounting methods.

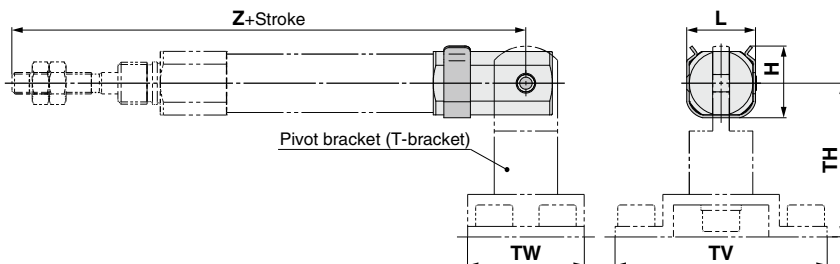

[mm]						
Applicable bore size	H	L	TH	TV	TW	Z
10	13.4	13.2	29	40	22	82
16	18.2	19.5	35	48	28	85

*: The pivot bracket (T-bracket) is the same as the standard type. Refer to page 63-1 for details.



Specific Product Precautions

Be sure to read this before handling the products. Refer to back page 50 for Safety Instructions and pages 3 to 12 for Actuator and Auto Switch Precautions.

Mounting

⚠ Warning

1. Use within the specified cylinder speed and kinetic energy ranges.

Otherwise, cylinder and seal damage may occur.

2. Do not apply excessive lateral load to the piston rod.

Easy checking method

Minimum operating pressure after the cylinder is mounted to the equipment (MPa) = Minimum operating pressure of cylinder (MPa) + {Load weight (kg) x Friction coefficient of guide/Sectional area of cylinder (mm²)}

If smooth operation is confirmed within the above value, the load on the cylinder is the resistance of the thrust only and it can be judged as having no lateral load.

3. Do not open the cushion needle after rotating it numerous times in a row. Though uncommon, there are cases in which the cushion needle may leak air.

The cushion needle should be adjusted by gradually opening it while checking the operation of the cylinder cushion.

⚠ Caution

1. During installation, secure the cover on the tightening side and tighten by applying an appropriate tightening force to the retaining nut or to the cover on the tightening side.

If the cover on the opposite side of the tightening side is secured or tightened, the cover could rotate, leading to the deviation.

2. Tighten the retaining screws to an appropriate tightening torque within the range given below.

ø6: 2.1 to 2.5 N·m, ø10: 5.9 to 6.4 N·m

ø16: 10.8 to 11.8 N·m

3. To remove and install the retaining ring for the knuckle pin or the clevis pin, use an appropriate pair of pliers (tool for installing a type C retaining ring). In particular, use a pair of ultra-mini pliers for removing and installing the retaining ring on the ø10 cylinder.

4. In the case of auto switch rail mounting type, do not remove the rail that is mounted. Because retaining screws extend into the cylinder, this could lead to an air leak.

5. Please contact SMC when the stroke exceeds 100 mm for the axial foot mounting type.

<Precautions on the single acting cylinder>

- 1) Do not operate it in such a way that a load would be applied during the retraction of the piston rod of the spring return type, or during the extension of the piston rod of the spring extend type. The spring that is built into the cylinder provides only enough force to retract the piston rod. Thus, if a load is applied, the piston rod will not be able to retract to the end of the stroke.
- 2) A breather hole is provided in the cover surface. Make sure not to block this hole during installation, as this could lead to a malfunction.

<Precautions on the non-rotating cylinder>

- 1) Tighten the retaining screws to an appropriate tightening torque within the range given below.
ø10: 10.8 to 11.8 N·m, ø16: 20 to 21 N·m
- 2) Do not operate it in such a way that rotational torque would be applied to the piston rod. If rotational torque is applied, the non-rotating guide will become deformed, thus affecting the non-rotating accuracy.

Allowable rotational torque [N·m]	ø10	ø16
		0.02

- 3) To screw a bracket onto the threaded portion at the tip of the piston rod, make sure to retract the piston rod entirely, and place a wrench over the flat portion of the rod that protrudes. To tighten, take precautions to prevent the tightening torque from being applied to the non-rotating guide.

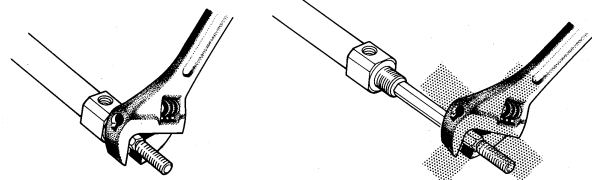

CJ1

CJP

CJ2

JCM

CM2

CM3

CG1

CG3

JMB

MB

MB1

CA2

CS1

CS2

D-

-X

Technical Data