

Autonics

**Photoelectric Sensor
BEN SERIES**

INSTRUCTION MANUAL



Thank you for choosing our Autonics product.
Please read the following safety considerations before use.

■ Safety Considerations

- ※Please observe all safety considerations for safe and proper product operation to avoid hazards.
- ※⚠ symbol represents caution due to special circumstances in which hazards may occur.
- ⚠ Warning** Failure to follow these instructions may result in serious injury or death.
- ⚠ Caution** Failure to follow these instructions may result in personal injury or product damage.
- ⚠ Warning**
 - Fall-safe device must be installed when using the unit with machinery that may cause serious injury or substantial economic loss.** (e.g. nuclear power control, medical equipment, ships, vehicles, railways, aircraft, combustion apparatus, safety equipment, crime/disaster prevention devices, etc.)
Failure to follow this instruction may result in personal injury, economic loss or fire.
 - Do not use the unit in the place where flammable/explosive/corrosive gas, high humidity, direct sunlight, radiant heat, vibration, impact, or salinity may be present.**
Failure to follow this instruction may result in explosion or fire.
 - Do not disassemble or modify the unit.**
Failure to follow this instruction may result in fire or electric shock.
 - Do not connect, repair, or inspect the unit while connected to a power source.**
Failure to follow this instruction may result in fire or electric shock.
 - Check 'Connections' before wiring.**
Failure to follow this instruction may result in fire.

- ⚠ Caution**
 - Use the unit within the rated specifications.**
Failure to follow this instruction may result in fire or product damage.
 - Use dry cloth to clean the unit, and do not use water or organic solvent.**
Failure to follow this instruction may result in fire or electric shock.
 - Do not use a load over the range of rated relay specification.**
Failure to follow this instruction may result in fire, relay broken, contact melt, insulation failure or contact failure.

■ Ordering Information

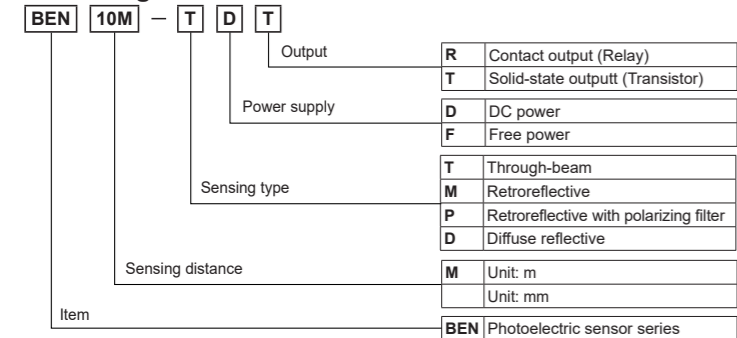

■ Control Output Circuit Diagram

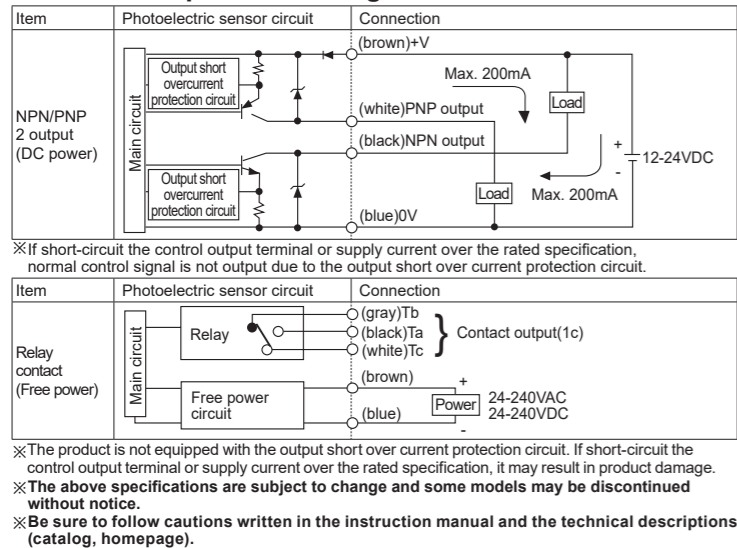

■ Dimensions

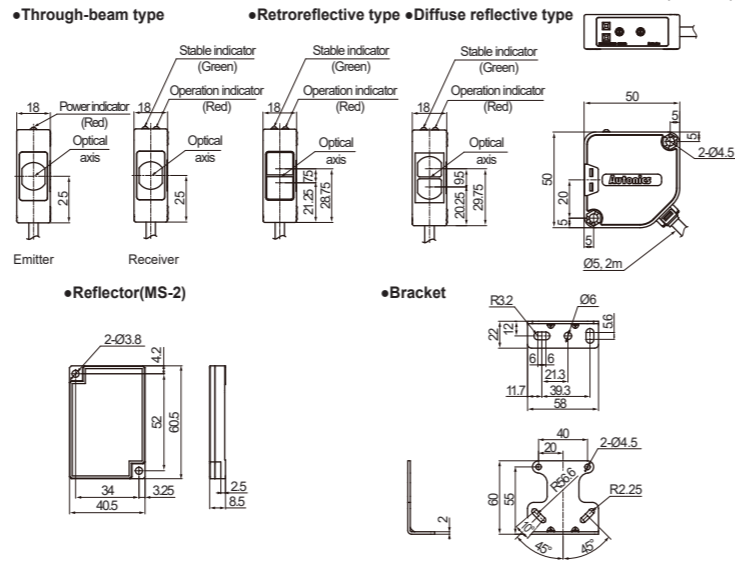

■ Timing Diagram Operation

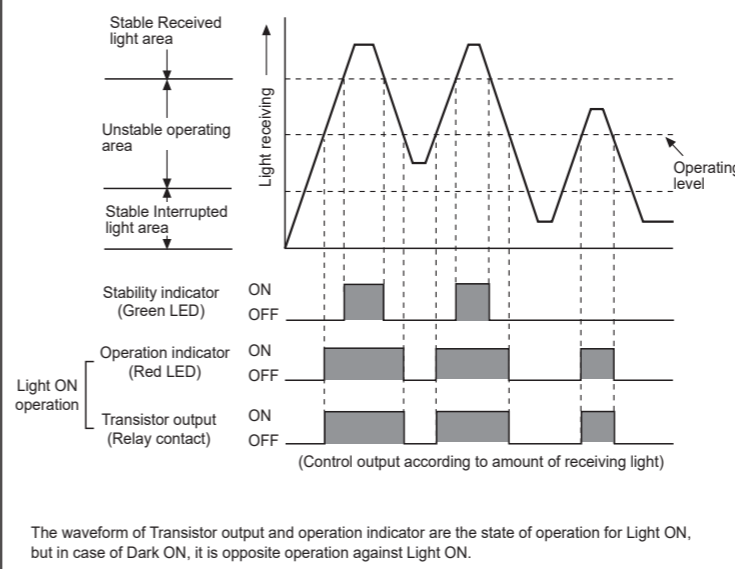

■ Specifications

| Type | Free power, Relay contact output | | | | DC power, Solid state output | | | |
|-------------------------|---|--------------------------------|---|---|--|--------------------------------|---|---|
| | Through-beam | Retroreflective*1 | Retroreflective*1 (with polarizing filter) | Diffuse reflective | Through-beam | Retroreflective*1 | Retroreflective*1 (with polarizing filter) | Diffuse reflective |
| Model | BEN10M-TFR | BEN5M-MFR | BEN3M-PFR | BEN300-DFR | BEN10M-TDT | BEN5M-MDT | BEN3M-PDT | BEN300-DDT |
| Sensing distance | 10m | 0.1 to 5m | 0.1 to 3m | 300mm(100 x 100mm non-glossy white paper) | 10m | 0.1 to 5m | 0.1 to 3m | 300mm(100 x 100mm non-glossy white paper) |
| Sensing target | Opaque materials of min. ø16mm | Opaque materials of min. ø60mm | Opaque materials of min. ø60mm | Translucent, opaque materials | Opaque materials of min. ø16mm | Opaque materials of min. ø60mm | Opaque materials of min. ø60mm | Translucent, Opaque materials |
| Hysteresis | - | - | - | Max. 20% at sensing distance | - | - | - | Max. 20% at sensing distance |
| Response time | Max. 20ms | - | - | - | Max. 1ms | - | - | - |
| Power supply | 24-240VAC~ ±10% 50/60Hz, 24-240VDC= ±10% (ripple P-P: max. 10%) | | | | 12-24VDC= ±10% (ripple P-P: max. 10%) | | | |
| Power consumption | Max. 4VA | | | | - | | | |
| Current consumption | - | | | | Max. 50mA | | | |
| Light source | Infrared LED (850nm) | | Red LED (660nm) | Infrared LED (940nm) | Infrared LED (850nm) | | Red LED (660nm) | Infrared LED (940nm) |
| Sensitivity adjustment | - | | Sensitivity adjuster | - | - | | Sensitivity adjuster | - |
| Operation mode | Selectable Light ON or Dark ON by switch | | | | | | | |
| Control output | Relay contact output •Relay contact capacity: 30VDC= 3A of resistive load, 250VAC~ 3A of resistive load •Relay contact composition: 1c | | | | NPN open collector/PNP open collector simultaneous output •Load voltage: max. 30VDC= •Load current: max. 200mA •Residual voltage - NPN: max. 1VDC=, PNP: max. 2.5VDC | | | |
| Relay lifetime | Mechanically: Min. 50,000,000 operation, Electrically: Min. 100,000 operation | | | | - | | | |
| Protection circuit | - | | | | Reverse polarity protection circuit, output short overcurrent protection circuit | | | |
| Light receiving element | Photo IC | | | | | | | |
| Indication | Operation indicator: red, stable indicator: green (the red lamp on Emitter of through-beam type is for power indication) | | | | | | | |
| Insulation resistance | Over 20MΩ (at 500VDC megger) | | | | | | | |
| Insulation type | Double or strong insulation (mark: □, Dielectric voltage between the measured input and the power: 1kV) | | | | | | | |
| Noise immunity | ±1000V the square wave noise (pulse width: 1μs) by the noise simulator | | | | ±240V the square wave noise (pulse width: 1μs) by the noise simulator | | | |
| Dielectric strength | 1000VAC 50/60Hz for 1minute | | | | | | | |
| Vibration | Mechanical: 1.5mm amplitude at frequency of 10 to 55Hz in each of X, Y, Z directions for 2 hours Malfunction: 1.5mm amplitude at frequency of 10 to 55Hz in each of X, Y, Z directions for 10 minutes | | | | | | | |
| Shock | Mechanical: 500m/s ² (50G) in X, Y, Z directions for 3 times Malfunction: 100m/s ² (10G) in X, Y, Z directions for 3 times | | | | | | | |
| Environment | Ambient illumination: Sunlight: max. 11,000lx, Incandescent lamp: max. 3,000lx (receiver illumination) Ambient temperature: -20 to 65°C, storage: -25 to 70°C Ambient humidity: 35 to 85%RH, storage: 35 to 85%RH | | | | | | | |
| Protection structure | IP50 (IEC standard) | | | | | | | |
| Material | •Case, case cover: heat resistant ABS •Sensing part: PC (with polarizing filter: PMMA) | | | | | | | |
| Cable | ø5.0mm, 5-wire, length: 2m (emitter of through-beam type: ø5.0mm, 2-wire, length: 2m) (AWG22, core diameter: 0.08mm, number of cores: 60, insulator diameter: ø1.25mm) | | | | ø5.0mm, 4-wire, length: 2m (emitter of through-beam type: ø5.0mm, 2-wire, length: 2m) (AWG22, core diameter: 0.08mm, number of cores: 60, insulator diameter: ø1.25mm) | | | |
| Accessories | Individual | Reflector (MS-2) | | - | - | Reflector (MS-2) | | - |
| Common | Adjustment screwdriver, mounting bracket, M4 bolt: 4, M4 nut: 4 | | Adjustment screwdriver, mounting bracket, M4 bolt: 2, M4 nut: 2 | | Adjustment screwdriver, mounting bracket, M4 bolt: 4, M4 nut: 4 | | Adjustment screwdriver, mounting bracket, M4 bolt: 2, M4 nut: 2 | |
| Approval | CE | | | | | | | |
| Unit weight | Approx. 354g | Approx. 208g | Approx. 195g | Approx. 342g | Approx. 200g | Approx. 187g | Approx. 187g | Approx. 187g |

※1: The sensing range and the sensing object of the retroreflective sensor are specified with using the MS-2 reflector. The sensing ranges of the retroreflective sensor in the above table are identified as the possible setting ranges of the MS-2 reflector. The sensor can detect on object under 0.1m apart.
※The temperature or humidity mentioned in Environment indicates a non freezing or condensation environment.

■ Connection

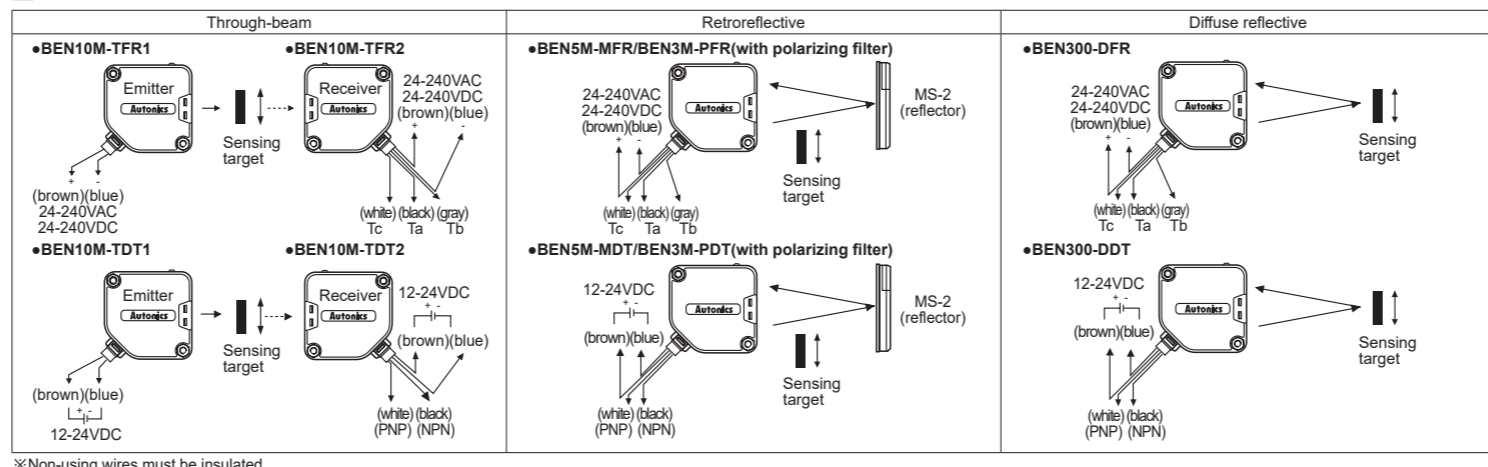

■ Mounting and Adjustment

- When using photoelectric sensors closely over two units, it may result in malfunction due to mutual interference.
When installing the product, tighten the screw with a tightening torque of 1.2N·m.
- Through-beam type
 - Supply the power to the photoelectric sensor, after setting the emitter and the receiver in face to face.
 - Set the receiver in center of position where indicator turns on, as adjusting the receiver and the emitter right and left.
 - Adjust up and down direction as the same.
 - After adjustment, check the stability of operation putting the object at the optical axis.

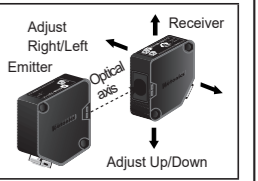

- Retroreflective type
 - Supply the power to the photoelectric sensor, after setting the photoelectric sensor and the reflector (MS-2) in face to face.
 - Set the photoelectric sensor in the position which indicator turns on, as adjusting the mirror or the sensor right and left.
 - Adjust up and down direction as the same.
 - After adjustment, check the stability of operation putting the object at the optical axis.

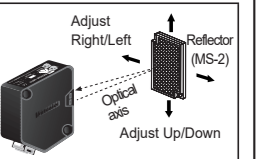

- ※If use more than 2 photoelectric sensors in parallel, the space between them should be more than 30cm.
- ※If reflectance of target is higher than non-glossy white paper, it might cause malfunction by reflection from the target when the target is near to photoelectric sensor. Therefore put enough space between the target and photoelectric sensor or the surface of target should be installed at an angle of 30 to 45° against optical axis. (When sensing target with high reflectance near by, photoelectric sensing with the polarizing filter should be used.)
- ※Sensitivity adjustment: Please see the diffuse reflective type.

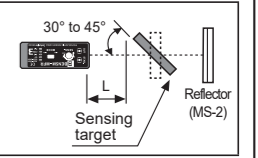

- Diffuse reflective type
 - Even though the diffuse reflective type is set at max. sensitive position, sensitivity of the sensor must be adjusted according to the existence of the reflective material in background.
 - Set the target at a position to be detected by the beam, then turn the adjuster until point ② where the indicator turn on from min. position of the adjuster.
 - Take the target out of the photoelectric sensor, then turn the adjuster until point ① which the indicator turns on, if the indicator does not turn on, max. sensitive position will be point ②.
 - Set the adjuster at the middle of two switching point ①, ②.

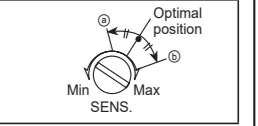
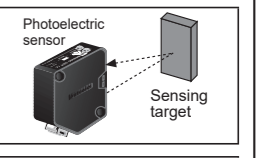

※The sensing distance indicated on specification chart is against 100 x 100mm of non-glossy white paper. Be sure that it can be different by size, surface and gloss of target.

■ Cautions during Use

- Follow instructions in 'Cautions during Use'. Otherwise, it may cause unexpected accidents.
- When connecting a DC relay or other inductive load to the output, remove surge by using diodes or varistors.
- Use the product, 0.5 sec after supplying power.
- When using separate power supply for the sensor and load, supply power to sensor first.
- 12-24VDC power supply should be insulated and limited voltage/current or Class 2, SELV power supply device.
- Wire as short as possible and keep away from high voltage lines or power lines, to prevent inductive noise.
- When using switching mode power supply to supply the power, ground F.G. terminal and connect a condenser between 0V and F.G. terminal to remove noise.
- When using sensor with the equipment which generates noise (switching regulator, inverter, servo motor, etc.), ground F.G. terminal of the equipment.
- This unit may be used in the following environments.
 - ①Indoors (in the environment condition rated in 'Specifications')
 - ②Altitude max. 2,000m
 - ③Pollution degree 2
 - ④Installation category II

■ Major Products

- Photoelectric Sensors
- Temperature Controllers
- Fiber Optic Sensors
- Temperature/Humidity Transducers
- Door Sensors
- SSRs/Power Controllers
- Door Side Sensors
- Counters
- Area Sensors
- Timers
- Proximity Sensors
- Panel Meters
- Pressure Sensors
- Tachometers/Pulse (Rate) Meters
- Rotary Encoders
- Display Units
- Connector/Sockets
- Sensor Controllers
- Switching Mode Power Supplies
- Control Switches/Lamps/Buzzers
- I/O Terminal Blocks & Cables
- Stepper Motors/Drivers/Motion Controllers
- Graphic/Logic Panels
- Field Network Devices
- Laser Marking System (Fiber, Co., Nd:Yag)
- Laser Welding/Cutting System

Autonics Corporation
http://www.autonics.com

HEADQUARTERS:
18, Bansong-ro 513beon-gil, Haeundae-gu, Busan, South Korea, 48002
TEL: 82-51-519-3232
E-mail: sales@autonics.com