

# BA Series Terminal Blocks

**Quick-mount terminal blocks for mounting on 35-mm-wide DIN rails. Current capacities from 16A to 370V (1250V).**

- Snaps on to 35-mm-wide DIN rails.
- Wide range of current capacities from 16A to 370A. Insulation voltage is 1250V.
- No end plates are required.
- 3-pole units, fuse blocks with blown fuse indicators available.
- Large capacity types (BA811S, BA911S) can be mounted directly to panels.
- Material: PPE (black)
- Complies with JIS C 2811.
- UL recognized and CSA certified. (BA111T, BA211T, BA311T, BA411S, BAF111SU, BAF111SNU)

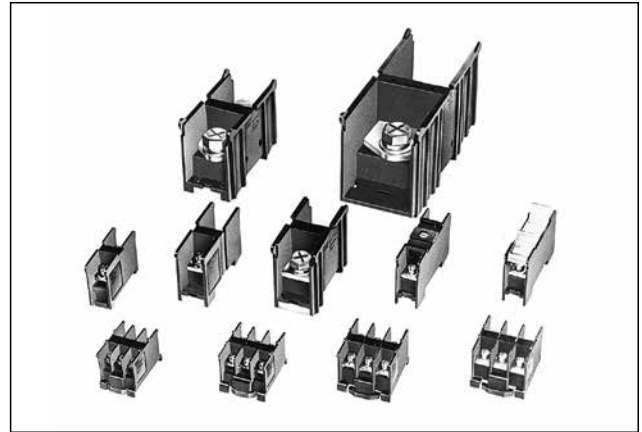

Applicable Standards	Mark	Certification Organization/ File No.
UL1059		UL recognized File No. E78117
CSA 22.2 No. 158		CSA (File No. LR64803)

Quick-mount    Unlatch    No end plates required

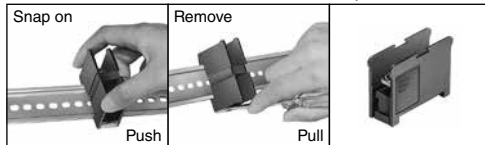

## General Ratings

Dielectric Strength	2500V AC, 1 minute
Insulation Resistance	100MΩ minimum
Operating Temperature	-25 to +55°C (no freezing)
Storage Temperature	-25 to 70°C (no freezing)
Operating Humidity	45 to 85% RH (no condensation)

## Terminal Blocks

Style	Part No.	Ordering No.	UL/CSA		JIS			Terminal Screw	Tightening Torque (N·m)	Package Quantity		
			Voltage/Current	Wire Size (AWG)	Voltage	Current	Wire Size (mm <sup>2</sup> )					
3-pole	Self-Lifting	<b>BA111T</b>	<b>BA111TPN20</b>	300V/15A	22-14	630V	16A 21A	1.25 mm <sup>2</sup> 2 mm <sup>2</sup>	M3	0.6 to 1.0	20	
		<b>BA211T</b>	<b>BA211TPN20</b>	300V/20A	22-12	630V	21A	2 mm <sup>2</sup> (3.5 mm <sup>2</sup> )	M3.5	1.0 to 1.3	20	
		<b>BA311T</b>	<b>BA311TPN20</b>	150V/30A	18-10	630V	40A	5.5 mm <sup>2</sup>	M4	1.4 to 2.0	20	
1-pole	Self-Lifting	<b>BA411S</b>	<b>BA411SPN50</b>	600V/40A	16-6	630V	70A	14 mm <sup>2</sup>	M5	2.6 to 3.7	50	
		<b>BA611S</b>	<b>BA611SPN10</b>	—	—	1000V	94A	22 mm <sup>2</sup>	M6	3.9 to 5.4	10	
		<b>BA711S</b>	<b>BA711SPN06</b>	—	—	1000V	132A	38 mm <sup>2</sup>	M8	10 to 13.5	6	
	Large Capacity	<b>BA811S</b>	<b>BA811SPN06</b>	—	—	1250V	240A	100 mm <sup>2</sup>	M10	21 to 28	6	
		<b>BA911S</b>	<b>BA911SPN06</b>	—	—	1250V	370A	200 mm <sup>2</sup> (200 mm <sup>2</sup> 2 wires) (325 mm <sup>2</sup> 1 wire)	M12	38 to 49	6	
		Fuse	<b>BAF111S-□</b>	<b>BAF111S-□PN20</b>	—	—	1000V	10A	5.5 mm <sup>2</sup>	M4	1.4 to 2.0	20
		Fuse with Lamp	<b>BAF111SN-□</b>	<b>BAF111SN-□PN20</b>	—	—	1000V	10A	5.5 mm <sup>2</sup>	M4	1.4 to 2.0	20
	Without Fuse/With Lamp	<b>BAF111SU</b>	<b>BAF111SUPN20</b>	600V/10A	18-10	1000V	10A	5.5 mm <sup>2</sup>	M4	1.4 to 2.0	20	
		<b>BAF111SNU</b>	<b>BAF111SNUPN20</b>	600V/10A	18-10	1000V	10A	5.5 mm <sup>2</sup>	M4	1.4 to 2.0	20	
		With Disconnecting Switch	<b>BAT20</b>	<b>BAT20PN20</b>	—	—	1000V	20A	5.5 mm <sup>2</sup>	M4	1.4 to 2.0	20

1. Specify fuse ratings 1A, 3A, or 5A in place of □ in the Part No.
2. The wire size in ( ) does not comply with JIS standards.
3. The voltage/current differ according to operating conditions. See "Selecting Terminal Blocks by Current According to JIS Standards" on page 4.
4. Use a socket wrench or screwdriver for tightening screws.

○: Order when a marking strip or a dust cover is needed.

▲: Used for surface mounting

\*: Dust cover with fuse holder

Part No.	Accessories (× Necessary)						
	DIN Rail	End Clip	Marking Strip	Dust Cover	Connecting Rod	Connecting Nut	Surface Mounting Clip
<b>BA111T, BA411S, BAT20, BA211T, BA611S, BA711S, BA311T</b>	×	×	○	○	—	—	—
<b>BA811S, BA911S</b>	×	×	○	○	×	×	▲
<b>BAF111S□, BAF111SN□, BAF111SU, BAF111SNU</b>	×	×	○	*	—	—	—

## Material

Parts Name	Material
Housing	Polyamide
Bus Bar	Brass (nickel-plated)
Terminal Screw	Steel (zinc chrome-plated)

# BA Series Terminal Blocks

## BA111T (3 Pole) 16A M3

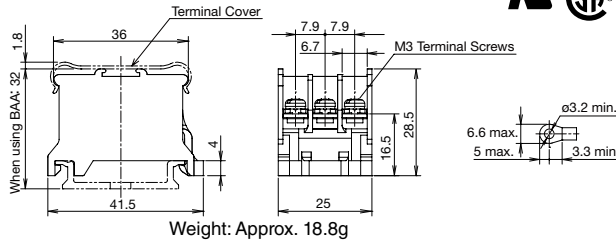

Standards	UL/CSA	JIS
Insulation Voltage	300V	630V
Rated Current *2	15A max.	16A/21A
Dielectric Strength	2,500V AC, 1 minute	
Insulation Resistance	100 MΩ minimum	
Wire Size *1	22-14 AWG	1.25 mm <sup>2</sup> / 2 mm <sup>2</sup>
Accessories	Marking Strip Width	9.5 mm (BNM7, BNM9, BNM725)
	Dust Cover	BNC220
	Rail	BAP1000, BAA1000
	See page	31

## BA211T (3 Pole) 21A M3.5

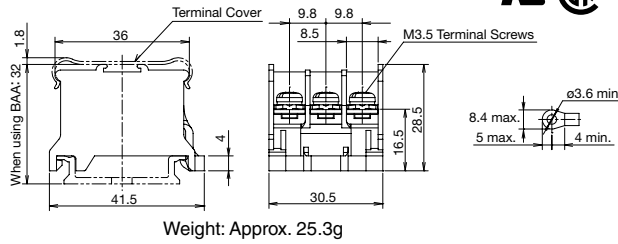

Standards	UL/CSA	JIS
Insulation Voltage	300V	630V
Rated Current *2	20A max.	21A
Dielectric Strength	2,500V AC, 1 minute	
Insulation Resistance	100 MΩ minimum	
Wire Size *1	22-12 AWG	2 mm <sup>2</sup> (3.5 mm <sup>2</sup> )
Accessories	Marking Strip Width	9.5 mm (BNM7, BNM9, BNM725)
	Dust Cover	BNC220
	Rail	BAP1000, BAA1000
	See page	31

## BA311T (3 Pole) 40A M4

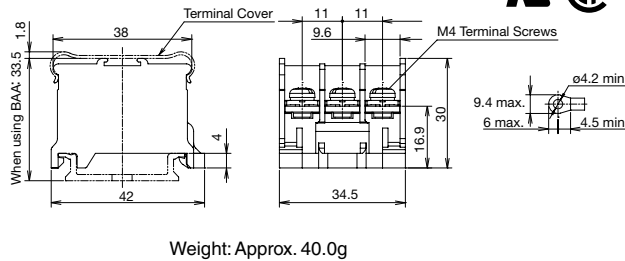
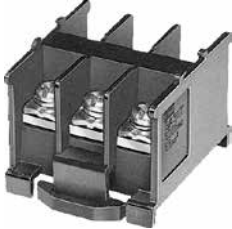

Standards	UL/CSA	JIS
Insulation Voltage	150V	630V
Rated Current *2	30A max.	40A
Dielectric Strength	2,500V AC, 1 minute	
Insulation Resistance	100 MΩ minimum	
Wire Size *1	18-10 AWG	5.5 mm <sup>2</sup>
Accessories	Marking Strip Width	9.5 mm (BNM7, BNM9, BNM725)
	Dust Cover	BNC230
	Rail	BAP1000, BAA1000
	See page	31

## BA411S 70A M5

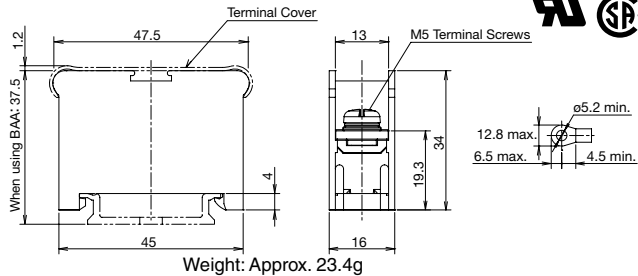

Standards	UL/CSA	JIS
Insulation Voltage	600V	630V
Rated Current *2	40A max.	70A
Dielectric Strength	2,500V AC, 1 minute	
Insulation Resistance	100 MΩ minimum	
Wire Size *1	16-6 AWG	14 mm <sup>2</sup>
Accessories	Marking Strip Width	9.5 mm (BNM7, BNM9, BNM725)
	Dust Cover	BNC320
	Rail	BAP1000, BAA1000
	See page	31

## BA611S 94A M6

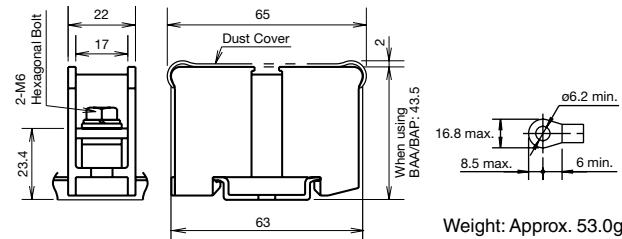
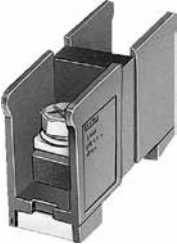

Socket wrench: 12.7 mm square drive hexagonal socket 10 \*3

Insulation Voltage	1000V	
Rated Current *2	94A max.	
Dielectric Strength	2,500V AC, 1 minute	
Insulation Resistance	100 MΩ minimum	
Wire Size	22 mm <sup>2</sup>	
Accessories	Marking Strip Width	9.5 mm (BNM7, BNM9, BNM725)
	Dust Cover	BNC520
	Rail	BAP1000, BAA1000
	See page	31

## BA711S 132A M8

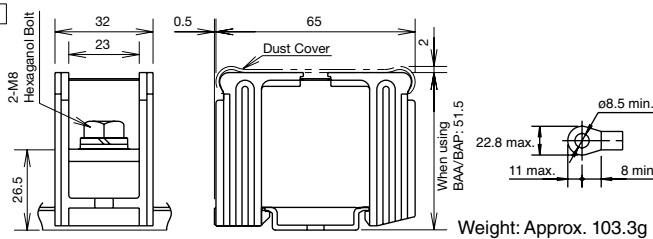
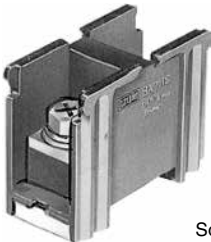

Socket wrench: 12.7 mm square drive hexagonal socket 13 \*3

Insulation Voltage	1000V	
Rated Current *2	132A max.	
Dielectric Strength	2,500V AC, 1 minute	
Insulation Resistance	100 MΩ minimum	
Wire Size	38 mm <sup>2</sup>	
Accessories	Marking Strip Width	9.5 mm (BNM7, BNM9, BNM725)
	Dust Cover	BNC520
	Rail	BAP1000, BAA1000
	See page	31

\*1: The wire size in ( ) does not comply with JIS standards.

\*2: The voltage/current differ according to operating conditions. See "Selecting Terminal Blocks by Current According to JIS Standards" on page 4.

\*3: Screws can be tightened with a socket wrench.

\*4: The grooves on the head of the hex bolt are for temporary tightening. For proper tightening, use an applicable socket wrench and tighten within the range of the recommended tightening torque.

# BA Series Terminal Blocks

## BA811S 240A M10



Socket wrench: 12.7 mm square drive hexagonal socket 17

Weight: Approx. 185.0g

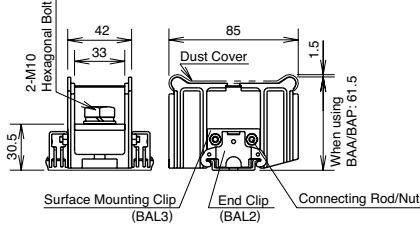

## BA911S 370A M12



Socket wrench: 12.7 mm square drive hexagonal socket 19

Weight: Approx. 406.3g

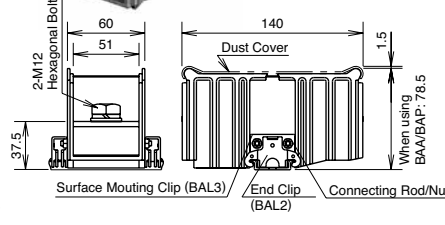

Part No.	BA811S	BA911S
Insulation Voltage	1250V	
Rated Current *2	240A	370 (400A)
Dielectric Strength	2,500V AC, 1 minute	
Insulation Resistance	100MΩ minimum	
Wire Size	100 mm <sup>2</sup>	200 mm <sup>2</sup> *1 (200 mm <sup>2</sup> 2 wires) (325 mm <sup>2</sup> 1 wire)
Terminal Screw	M10	M12
Accessories	Connecting Rod	BNR1, BNR2, BNL8
	Connecting Nut	BAN1
	End Clip/ Surface Mounting Clip	BAL2, BAL3
	Marking Strip Width	9.5 mm (BNM7, BNM9, BNM725)
	Dust Cover	BAC820 BNC92
	Rail	BAP1000, BAA1000
	See page	31

### Surface Mounting

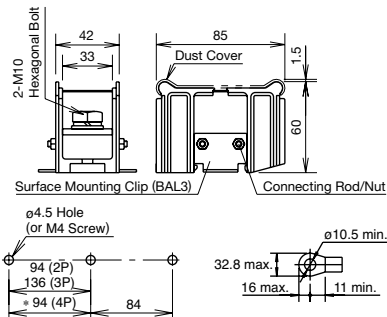

### Surface Mounting

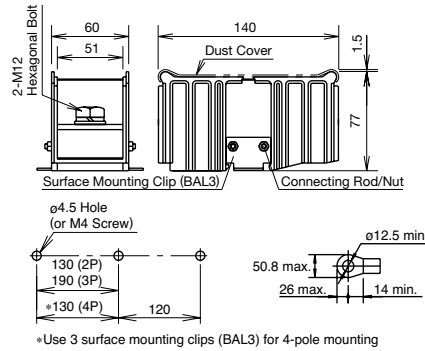

## BAF111S (Fuse) 10A M4

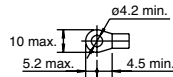
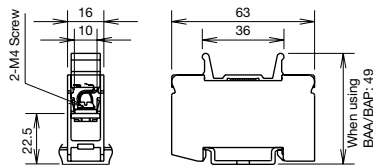

• BAF111SN is equipped with a neon lamp (for 100 or 200V AC) which turns on when the fuse is blown.

#### Internal Connection

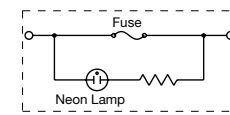

### BAF111S (with fuse)/BAF111SN (with fuse/lamp)

Insulation Voltage	1000V	
Rated Current	10A max. (depends on fuse rating)	
Dielectric Strength	2,500V AC, 1 minute	
Insulation Resistance	100MΩ minimum	
Wire Size	5.5 mm <sup>2</sup>	
Terminal Screw	M4	
Accessories	Marking Strip Width	9.5mm (BNM7, BNM9, BNM725)
	Dust Cover	—
	Rail	BAP1000, BAA1000
	See page	31

• Fuse ratings  
Rated voltage: 250V  
Rated current: 1, 3, 5A  
Cartridge fuse: JIS C6575-2  
6.35×31.8 mm

Part No.  
BAF111S-1A  
BAF111S-3A  
BAF111S-5A  
BAF111SN-1A  
BAF111SN-3A  
BAF111SN-5A

### BAF111S (with fuse)/BAF111SN (without fuse/with lamp)

Insulation Voltage	1000V	
Rated Current	10A max. (depends on fuse rating)	
Dielectric Strength	2,500V AC, 1 minute	
Insulation Resistance	100 MΩ minimum	
Wire Size	18-10 AWG	
Terminal Screw	M4	
Accessories	Marking Strip Width	9.5 mm (BNM7, BNM9, BNM725)
	Dust Cover	—
	Rail	BAP1000, BAA1000
	See page	31

• Use UL/CSA approved fuses (10A maximum)  
• Fuse size  
6.35×31.8 mm  
6.40×30 mm

## BAT20 (With Disconnecting Switch) 20A M4

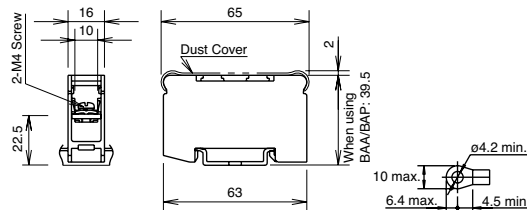
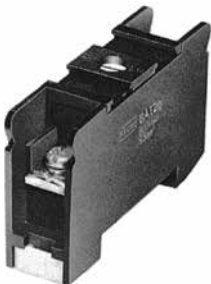

Insulation Voltage	1000V	
Rated Current	20A	
Dielectric Strength	2,500V AC, 1 minute	
Insulation Resistance	100 MΩ minimum	
Wire Size	5.5 mm <sup>2</sup> max.	
Terminal Screw	M4	
Accessories	Marking Strip Width	9.5 mm (BNM7, BNM9)
	Dust Cover	BNC520
	Rail	BAP1000, BAA1000
	See page	31

BAT20 is not capable of breaking circuits. Do not apply voltage when opening or closing the circuit. Turn the slot using a screwdriver.

\*1: The wire size in ( ) does not comply with JIS standards.

\*2: The rated current differs according to operating conditions. See "Selecting Terminal Blocks by Current According to JIS Standards" on page 4.

\*3: The grooves on the head of the hex bolt are for temporary tightening. For proper tightening, use an applicable socket wrench and tighten within the range of the recommended tightening torque.

# BA Series Terminal Blocks

## Accessories

### Rails



Length	Part No.	Ordering No.	Material	Weight (Approx.)	Package Quantity
1000 mm	<b>BAA1000</b> (Note)	<b>BAA1000PN10</b>	Aluminum	200g	10
	<b>BAP1000</b>	<b>BAP1000PN10</b>	Steel	320g	10

Note: 2000 mm is also available. Contact IDEC.

### Marking Strip (BNM)

Part No.	Ordering No.	Package Quantity	Dimensions	Material
<b>BNM7</b>	<b>BNM7PN10</b>	10	9.5 × 0.5t × 1m	PVC (glossy surface)
<b>BNM9</b>	<b>BNM9PN10</b>	10	9.5 × 0.5t × 1m	Fiber Glass (matte surface)
<b>BNM725</b>	<b>BNM725</b>	1	9.5 × 0.5t × 25m	PVC (glossy surface)

### End Clip

Used on the ends of a group of terminal blocks to secure and prevent sliding along the rails.

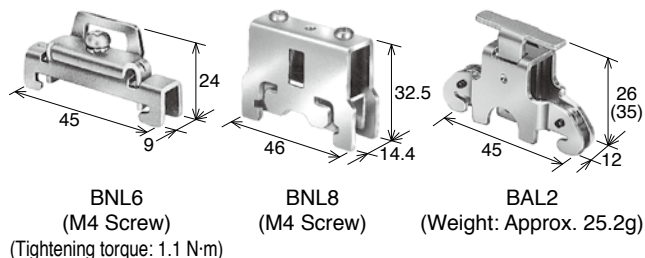

(Tightening torque: 1.1 N·m)

Material: Steel (zinc chrome-plated)

Part No.	Ordering No.	Package Quantity
<b>BNL6</b>	<b>BNL6PN10</b>	10
<b>BNL8</b>	<b>BNL8PN10</b>	10
<b>BAL2</b>	<b>BAL2PN10</b>	10

### Notes on Selecting End Clips

- When using BA611S, use BAL2 or BNL8. Also, when using BA711S, BA811S, BA911S of 100A or larger, use BAL2 or BNL8.
- When mounting rails vertically, use BAL2 or BNL8.

### Dust Cover

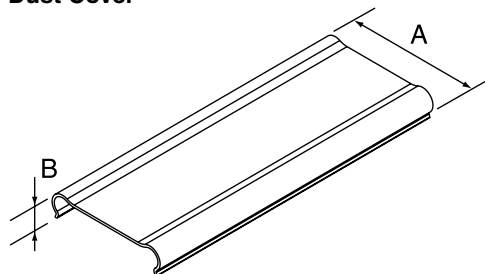

Material: Polycarbonate

Item	Part No.	Ordering No.	Size (mm)		Terminal Block	Package Quantity
			A	B		
Dust Cover (1m)	<b>BNC220</b>	<b>BNC220PN10</b>	37.6	8.5	BA111T, BA211T	10
	<b>BNC230</b>	<b>BNC230PN10</b>	39.6	8.5	BA311T	10
	<b>BNC320</b>	<b>BNC320PN10</b>	49.6	8.5	BA411S	10
	<b>BNC520</b>	<b>BNC520PN10</b>	65.0	9.0	BA611S, BA711S, BAT20	10
	<b>BAC820</b>	<b>BAC820PN10</b>	85.0	10.6	BA811S	10
Dust Cover (500 mm)	<b>BNC92</b>	<b>BNC92PN10</b>	140.5	9.8	BA911S	10

# BA Series Terminal Blocks

## Connecting Rod/Connecting Nut (For BA811S, BA911S)

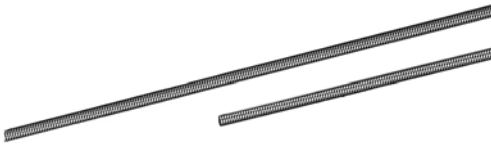

BNR1: M4 × 0.7 L = 265 (21.0g)  
BNR2: M4 × 0.7 L = 500 (43.0g)



BAN1: M4 × 0.7 (2.5g)

Item	Part No.	Ordering No.	Weight (Approx.)	Package Quantity	Remarks
Connecting Rod (265 mm)	<b>BNR1</b>	<b>BNR1PN10</b>	2.6g	10	M4 × 0.7
Connecting Rod (500 mm)	<b>BNR2</b>	<b>BNR2PN10</b>	43g	10	M4 × 0.7
Connecting Nut (4 pcs/set)	<b>BAN1</b>	<b>BAN1PN10</b>	2.5g	10	M4 × 0.7

## Surface Mounting Clip (For BA811S and BA911S Only)



Used on the ends of groups of terminal blocks for direct mounting to panels.

Material: Steel (zinc-chrome plated)

Part No.	Ordering No.	Weight (approx.)	Package Quantity
<b>BAL3</b>	<b>BAL3PN10</b>	12.4g	10

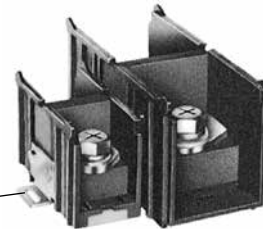

## Calculating Rail / Connecting Rod Length

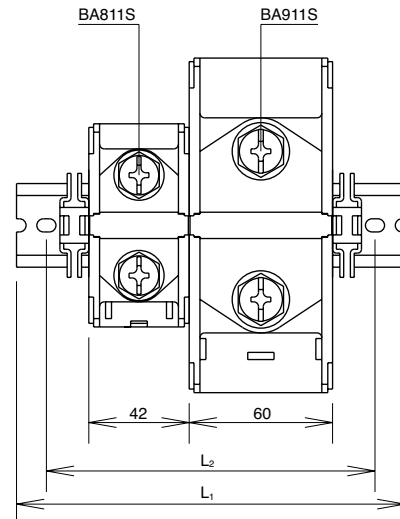
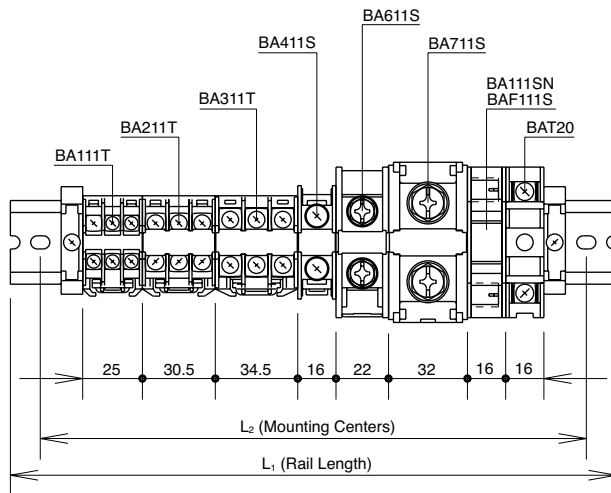

### Calculating Rail Length

For BAA, BAP rails

$$L_1 = 12.5 \times N$$

$$L_2 = L_1 - 25$$

A: Total thickness of each terminal block

B: Tolerance of stacking thickness

0.1 mm per block

C: End Clip

When using 2 pieces of BNL6 or BAL2 = 62.5

N: Rounded up numerical number from the calculated value of M.

(Example: N for 19.1 is 20)

$$M = \frac{A + B + C}{12.5}$$

Note: This formula is for calculating the maximum rail length including tolerance. The rail length may be shorter than the calculated value, depending on how the terminal blocks are combined.

### Calculating Connecting Rod Length

$$L = 42 \times n_1 + 60 \times n_2 + 10.2$$

n<sub>1</sub>: BA811S

n<sub>2</sub>: BA911S

n: The number of terminal blocks

# BA Series Terminal Blocks

## Instructions

### Installation of BA811S and BA911S

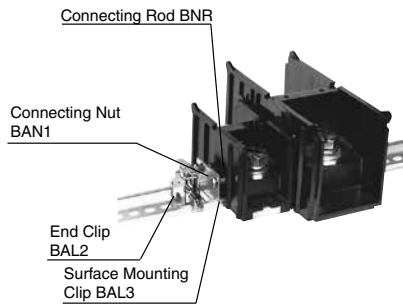

#### Rail Mount

1. Mount the terminal block on DIN rail.
2. Mount the surface mounting clips (BAL3) on both ends and slide 2 connecting rods (BNR) through the holes in the terminal blocks.
3. Tighten both ends of the connecting rod with a connecting nut (BAN1).
4. Secure the terminal blocks with end clips (BAL2).

#### Surface Mount

1. Mount the terminal block to the panel.
2. Mount the surface mounting clips (BAL3) on both ends and slide 2 connecting rods (BNR) through the holes in the terminal blocks.
3. Tighten both ends of the connecting rod with connecting nuts (BAN1).
4. Secure the terminal blocks to the panel.

### Notes on Wiring

#### Crimping Terminals

- When using crimping terminals, be sure to use insulated terminals to prevent electric shocks.

#### Without Crimping Terminals

- Insert the wire until the insulation comes into contact with the terminal metal part.
- Strip the insulation so that the wire is longer than the width of the wire clamp.
- When connecting two wires, use wires of the same size.

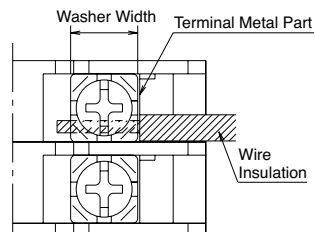

## Selecting Terminal Blocks by Current According to JIS Standards

IDEC's terminal blocks are compliant with JIS C 8201-7-1. The current varies depending on the operating conditions (wire type, number of bundle wire, operating temperature, etc.). See the table below for choosing the terminal block.

When using the terminal blocks as UL, CSA, and TÜV approved products, refer to UL, CSA, and TÜV ratings.

Applicable Wire (mm <sup>2</sup> )	1.25	2	3.5	5.5	8	14	22	38	60	100	150	200	240	325
Current (A)	16	21	30	40	50	70	94	132	175	240	310	370	430	520
Current vs. Temperature Rise at Bus Bars	(1)	(2)	(3)	(4)	(5)	(6)	(7)	(8)	(9)	(10)	(11)	(12)	(13)	(14)
Applicable IDEC Terminal Block	BN10W BNH10W BN15MW BNH15MW BND15W BNDH15W	BN15LW BNH15LW BN15MWT BNH15MWT BND15LW BNDH15LW BND15WT BNDH15WT	BN15LWT BNH15LWT	BN30W BNH30W	BN40W BNH40W	BN50W BNH50W	BN75W	BN100W	BN150W BN150NW	BN200BW BN200NW	BN300BW BN300NW	BN400BW BN400NW	BN500BW BN500NW	BN600NW
BA Series	BA111T	BA111T BA211T	—	BA311T	—	BA411S	BA611S	BA711S	—	BA811S	—	BA911S	—	
BTB Series	BTB15C BTBH15C	BTB15LC BTBH15LC	—	BTB30C BTBH30C	—	BTB50C BTBH50C	—							
BD Series	BD8 BD8S	—												

### Current vs. Temperature Rise at Bus Bars

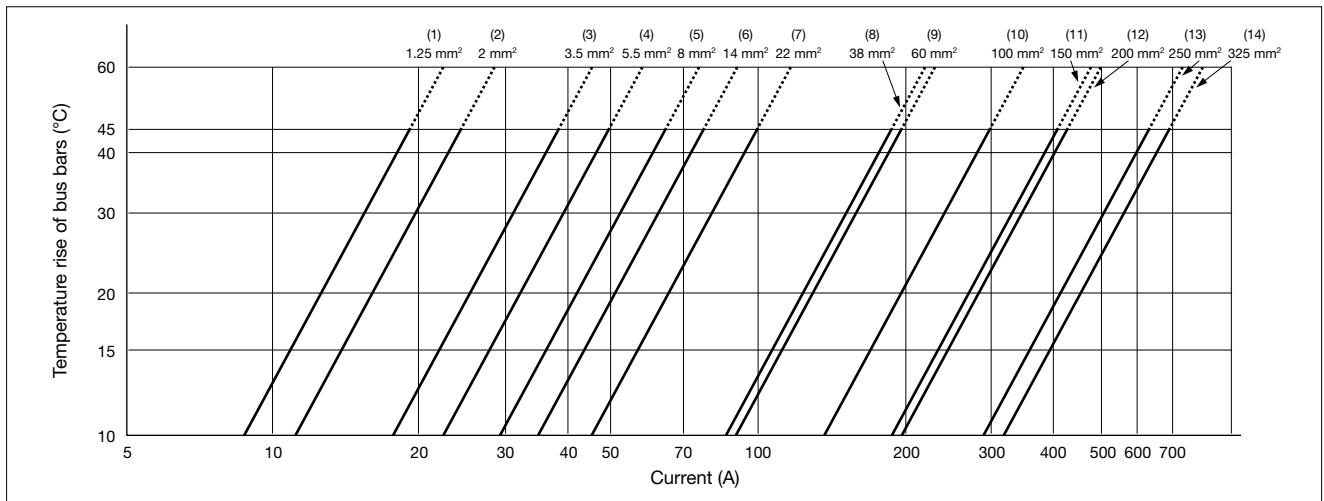

#### How to read the graph

When using IDEC terminal blocks, make sure that the operating temperature and the temperature of the bus bars do not exceed 100°C. However, the upper limit of the temperature rise is limited to 45°C by JIS C 8201-7-1.

$$\text{Operating temperature} + \text{Temperature rise at bus bars} \leq 100^\circ\text{C}$$

Note: Select wires according to the allowable temperature, operating temperature, and temperature rise of bus bars.

#### About SCCR of Terminal Block

When exporting machine or systems to the USA, the smallest short-circuit current rating of the control board's main circuit must be displayed as SCCR (short-circuit current rating) value. SCCR is specified by UL508A-2001, Supplement SB, Table SB4.1. The value is 10kA for terminal block.

# Ordering Terms and Conditions

Thank you for using IDEC Products.

By purchasing products listed in our catalogs, datasheets, and the like (hereinafter referred to as "Catalogs") you agree to be bound by these terms and conditions. Please read and agree to the terms and conditions before placing your order.

## 1. Notes on contents of Catalogs

- (1) Rated values, performance values, and specification values of IDEC products listed in this Catalog are values acquired under respective conditions in independent testing, and do not guarantee values gained in combined conditions.  
Also, durability varies depending on the usage environment and usage conditions.
- (2) Reference data and reference values listed in Catalogs are for reference purposes only, and do not guarantee that the product will always operate appropriately in that range.
- (3) The specifications / appearance and accessories of IDEC products listed in Catalogs are subject to change or termination of sales without notice, for improvement or other reasons.
- (4) The content of Catalogs is subject to change without notice.

## 2. Note on applications

- (1) If using IDEC products in combination with other products, confirm the applicable laws / regulations and standards.  
Also, confirm that IDEC products are compatible with your systems, machines, devices, and the like by using under the actual conditions. IDEC shall bear no liability whatsoever regarding the compatibility with IDEC products.
- (2) The usage examples and application examples listed in Catalogs are for reference purposes only. Therefore, when introducing a product, confirm the performance and safety of the instruments, devices, and the like before use. Furthermore, regarding these examples, IDEC does not grant license to use IDEC products to you, and IDEC offers no warranties regarding the ownership of intellectual property rights or non-infringement upon the intellectual property rights of third parties.
- (3) When using IDEC products, be cautious when implementing the following.
  - i. Use of IDEC products with sufficient allowance for rating and performance
  - ii. Safety design, including redundant design and malfunction prevention design that prevents other danger and damage even in the event that an IDEC product fails
  - iii. Wiring and installation that ensures the IDEC product used in your system, machine, device, or the like can perform and function according to its specifications
- (4) Continuing to use an IDEC product even after the performance has deteriorated can result in abnormal heat, smoke, fires, and the like due to insulation deterioration or the like. Perform periodic maintenance for IDEC products and the systems, machines, devices, and the like in which they are used.
- (5) IDEC products are developed and manufactured as general-purpose products for general industrial products. They are not intended for use in the following applications, and in the event that you use an IDEC product for these applications, unless otherwise agreed upon between you and IDEC, IDEC shall provide no guarantees whatsoever regarding IDEC products.
  - i. Use in applications that require a high degree of safety, including nuclear power control equipment, transportation equipment (railroads / airplanes / ships / vehicles / vehicle instruments, etc.), equipment for use in outer space, elevating equipment, medical instruments, safety devices, or any other equipment, instruments, or the like that could endanger life or human health
  - ii. Use in applications that require a high degree of reliability, such as provision systems for gas / waterworks / electricity, etc., systems that operate continuously for 24 hours, and settlement systems
  - iii. Use in applications where the product may be handled or used deviating from the specifications or conditions / environment listed in the Catalogs, such as equipment used outdoors or applications in environments subject to chemical pollution or electromagnetic interference  
If you would like to use IDEC products in the above applications, be sure to consult with an IDEC sales representative.

## 3. Inspections

We ask that you implement inspections for IDEC products you purchase without delay, as well as thoroughly keep in mind management/maintenance regarding handling of the product before and during the inspection.

## 4. Warranty

- (1) Warranty period  
The warranty period for IDEC products shall be one (1) year after purchase or delivery to the specified location. However, this shall not apply in cases where there is a different specification in the Catalogs or there is another agreement in place between you and IDEC.
- (2) Warranty scope  
Should a failure occur in an IDEC product during the above warranty period for reasons attributable to IDEC, then IDEC shall replace or repair that product, free of charge, at the purchase location / delivery location of the product, or an IDEC service base. However, failures caused by the following reasons shall be deemed outside the scope of this warranty.
  - i. The product was handled or used deviating from the conditions / environment listed in the Catalogs
  - ii. The failure was caused by reasons other than an IDEC product
  - iii. Modification or repair was performed by a party other than IDEC
  - iv. The failure was caused by a software program of a party other than IDEC
  - v. The product was used outside of its original purpose
  - vi. Replacement of maintenance parts, installation of accessories, or the like was not performed properly in accordance with the user's manual and Catalogs
  - vii. The failure could not have been predicted with the scientific and technical standards at the time when the product was shipped from IDEC
  - viii. The failure was due to other causes not attributable to IDEC (including cases of force majeure such as natural disasters and other disasters)Furthermore, the warranty described here refers to a warranty on the IDEC product as a unit, and damages induced by the failure of an IDEC product are excluded from this warranty.

## 5. Limitation of liability

The warranty listed in this Agreement is the full and complete warranty for IDEC products, and IDEC shall bear no liability whatsoever regarding special damages, indirect damages, incidental damages, or passive damages that occurred due to an IDEC product.

## 6. Service scope

The prices of IDEC products do not include the cost of services, such as dispatching technicians. Therefore, separate fees are required in the following cases.

- (1) Instructions for installation / adjustment and accompaniment at test operation (including creating application software and testing operation, etc.)
- (2) Maintenance inspections, adjustments, and repairs
- (3) Technical instructions and technical training
- (4) Product tests or inspections specified by you

The above content assumes transactions and usage within your region. Please consult with an IDEC sales representative regarding transactions and usage outside of your region. Also, IDEC provides no guarantees whatsoever regarding IDEC products sold outside your region.

# IDEC CORPORATION

**Head Office** 6-64, Nishi-Miyahara-2-Chome, Yodogawa-ku, Osaka 532-0004, Japan

 [www.idec.com](http://www.idec.com)

**USA** IDEC Corporation  
**EMEA** APEM SAS

**Singapore** IDEC Izumi Asia Pte. Ltd.  
**Thailand** IDEC Asia (Thailand) Co., Ltd.  
**India** IDEC Controls India Private Ltd.

**China** IDEC (Shanghai) Corporation  
IDEC Izumi (H.K.) Co., Ltd.  
**Taiwan** IDEC Taiwan Corporation

**Japan** IDEC Corporation

Specifications and other descriptions in this brochure are subject to change without notice.

2022 IDEC Corporation, All Rights Reserved.

