

Altivar[®] 31

Adjustable Speed AC Drives

Catalog
April

File 8800

05



CONTENTS

Description	Page
Product Overview	3
Technical Specifications	6
Selection	10
Accessories	12
Dimensions and Weights	22
Wiring	25
Mounting	29
Functions	32



Altivar® 31 Adjustable Speed AC Drives Drives Product Support

DRIVES PRODUCT SUPPORT

The Product Support Group is staffed from 8 am to 6 pm Eastern time for product selection, start-up assistance, or diagnosis of product problems and advice for the correct course of action. **Emergency phone support** is available 24 hours a day, 365 days a year.

Toll-free: 888-Square D (888-778-2733)

Telephone: 919-266-8600

E-mail: drive.products.support@us.schneider-electric.com

Fax: 919-217-6508

PRODUCT OVERVIEW



ATV31HU15M3X

The Altivar 31 (ATV31) adjustable speed AC drive controller incorporates the latest sensorless flux vector technology into a compact, easy-to-use design for three-phase asynchronous squirrel-cage motors. This versatile drive controller offers increased performance while maintaining cost-effectiveness. The ATV31 drive provides advanced speed control capabilities for motors from 0.25–20 hp (0.18 to 15 kW). The controllers range from:

- 0.25 to 3 hp (0.18 to 2.2 kW), 208/230/240 V, single-phase input
- 0.25 to 20 hp (0.18 to 15 kW), 208/230/240 V, three-phase input
- 0.5 to 20 hp (0.37 to 15 kW), 400/460/480 V, three-phase input
- 1 to 20 hp (0.75 to 15 kW), 525/575/600 V, three-phase input

Industrial users and OEMs who specialize in material handling, pump, fan, packing, packaging, and general purpose motor control applications will find the features and functions of the ATV31 drive controller well suited for their use.

Key benefits

- Saves valuable panel space with a compact design and side-by-side mounting capability up to 50 °C (122 °F)
- Designed as a robust and reliable fourth-generation drive
- Meets international standards
- Integrates Modbus® and CANopen protocols as standard into the drive controller, providing an economical solution for networking mini-drives into an industrial network
- Offers a choice of two integrated interfaces:
 - **ATV31•••••** with display and menu navigation keys ¹
 - **ATV31•••••A** with display, menu navigation keys, and local control via Run/Stop keys and speed reference potentiometer (not available for 575 V controllers)
- Supplied with a heatsink for normal environments and ventilated enclosures



ATV31H037M2A

Functions

The ATV31 drive controller has six logic inputs, three analog inputs, one logic/analog output, and two relay outputs. Integrated into the drive controller are the following main functions:

- Motor and drive protection
- Linear, S, U, and customized acceleration and deceleration ramps
- +/- Speed
- 16 preset speeds
- PI references and regulator
- Two-wire or three-wire control
- Brake sequence
- Automatic catch-on-the-fly with speed detection and automatic restart
- Fault configuration
- Stop type configuration
- Configuration saved in the drive controller
- Assignment of several functions to one logic input

1. A bullet (•) in the catalog number represents a digit that changes based on the drive specifications.

Altivar® 31 Adjustable Speed AC Drives

Field Installed Kits

Options and accessories

The following options and accessories are available for the ATV31 drive controller:

- Braking resistors
- EMC (RFI) input filters¹
- DIN rail mounting plates
- UL Type 1 conduit entrance kit
- Adapter plate for replacing an Altivar 28 (ATV28) drive controller
- User interface and communication options

FIELD INSTALLED KITS

Conduit entrance kits

This conduit box, allowing three or more conduit entries, attaches to the bottom of the drive controller. With the addition of this kit and without removal of the protective vent cover on the top of the drive, the degree of protection is UL Type 1.



Conduit entrance kit

ATV28 replacement kits

These brackets adapt the spacing of the ATV31 mounting holes to match the ATV28 drive controller, which allows the ATV31 drive to use the panel holes and mounting hardware already in place for the ATV28 controller.



ATV28 replacement kit

EMC (RFI) input filter

The EMC input filter allows the drive to comply with European (CE) conducted emissions standard EN55022 Class B. An EN55011 Class A filter is built into the ATV31 drive controller (ATV31••••N4, ATV31••••M2 only).

DIN rail kit

This kit allows DIN rail mounting of ATV31 drive controllers, frame sizes 1–6.

Dynamic braking resistor kits

Dynamic braking resistors packaged in UL Type 1 enclosures are available for high-inertia applications requiring rapid deceleration times. The kits mount separately.



Dynamic braking resistor

Remote keypad display mounting kit

This kit is used to mount a keypad display remotely, such as on the door of a wall-mounted or floor-standing enclosure. The remote keypad display offers the same features as the drive local keypad display, with the addition of (a) run, stop/reset, and forward/reverse buttons; and (b) an access locking switch. Up to four complete configurations can be stored in the remote keypad display and transferred to other drives of the same rating. The kit has an IP65 rating and includes a remote-mount keypad display, hardware, and a 3 m (10 ft) cable for saving and downloading configuration files.



Remote keypad display

1. EMC = electromagnetic compatibility; RFI = radio frequency interference.

Altivar® 31 Adjustable Speed AC Drives Catalog Numbers



power suite sw.tif

PowerSuite Software



power suite cable.tif

Cable and connectors

PowerSuite™ commissioning software for PCs and HP® Jornada® Pocket PCs

This Microsoft® Windows®-based software offers the following functionality:

- Display, configure, and adjust the parameters
- Upload and download configurations
- Operate the drive controller
- View the fault history
- Create or modify a configuration in stand-alone mode and transfer it to an ATV31 drive controller

New options have been added for the ATV31 drive, such as an oscilloscope function, parameter name customization, configuration locking using a password, and creation of a user menu.

Communication options

The ATV31 drive connects directly to Modbus and CANopen networks via an RJ45 connector, which supports both protocols. The communication function provides access to the drive controller's configuration, adjustment, control, and monitoring functions. Various communication options are available such as cables, junction boxes, and terminators.

Ethernet/Modbus bridge

The ATV31 drive can be connected to an Ethernet network via an Ethernet/Modbus bridge for control and monitoring. Ethernet communication is primarily intended for the following applications:

- Coordination with PLCs
- Local or centralized supervision
- Communication with production management software
- Communication with remote I/O
- Communication with industrial control products



563030

Ethernet/Modbus bridge



565031

FIPIO/Modbus gateway

Communication gateways

The ATV31 drive can connect to other communication networks via the following gateways for control and monitoring:

- Fipio/Modbus
- DeviceNet/Modbus
- Profibus DP/Modbus



565032

Profibus DP/Modbus gateway

CATALOG NUMBERS

Use the table below as a guide to interpreting ATV31 drive controller catalog numbers. ATV31HU15M2A is used as an example.

Drive controller family	Type	Rating	Voltage range	Variation
ATV31	H	U15	M2	A
	Heatsink product	0: 0 to 0.99 kW U: 1 to 9.99 kW D: 10 to 99.99 kW	M2: 200 V / 240 V, 1 phase M3X: 200 V / 240 V, 3 phase without filter N4: 380 V / 500 V, 3 phase S6X: 525 V / 600 V, 3 phase without filter	A: with local control panel

Altivar® 31 Adjustable Speed AC Drives

Technical Specifications

TECHNICAL SPECIFICATIONS

Environment

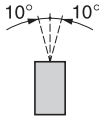
Degree of protection	<ul style="list-style-type: none"> • IP20 without protective vent cover, NEMA 1, UL open type • IP21 on wiring terminals • IP31 and IP41 all other areas • UL Type 1 without removal of the protective vent cover from the top of the controller and with the addition of the Conduit Entry Kit.
Resistance to vibration	Conforming to IEC/EN 60068-2-6: 1.5 mm peak to peak from 3 to 13 Hz, 1 gn from 13 to 150 Hz
Resistance to shock	15 g for 11 ms conforming to IEC/EN 60068-2-27
Pollution degree	Pollution degree 2 according to UL 840. Protect the drive against dust, corrosive gas, and falling liquid.
Maximum relative humidity	96% maximum, non-condensing and without dripping (provide heating system if there is condensation) Conforms to IEC 60068-2-3
Maximum ambient temperature	Storage: -13 to +158 °F (-25 to +70 °C) Operation: +14 to +122 °F (-10 to +50 °C) without vent cover removed and without derating; +14 to +140 °F (-10 to +60 °C) with vent cover removed and with derating. Refer to derating curves on page 30.
Altitude	Up to 3,300 ft (1,000 m) without derating; derate by 1% for each additional 330 ft (100 m)
Operating position Maximum permanent angle in relation to the normal vertical mounting position	

Electrical characteristics

Input voltage	ATV31••••M2 (1 phase): 200 V -15% to 240 V +10% ATV31••••M3X (3 phase): 200 V -15% to 240 V +10% ATV31••••N4 (3 phase): 380 V -15% to 460 V +15% ATV31••••S6X (3 phase): 525 V -15% to 575 V +15%
Input frequency	50/60 Hz ±5%
Input phases	ATV31••••M2: 1 ATV31••••M3X: 3 ATV31••••N4: 3 ATV31••••S6X: 3
Output voltage	Maximum voltage equal to input voltage
Output frequency	0 to 500 Hz
Output phases	3
Speed range	1:50
Transient overtorque	170–200% nominal motor torque (typical value)
Maximum transient current	Up to 150% of nominal drive controller current for 60 seconds
Braking torque	With braking resistor: 100% of nominal motor torque continuously and up to 150% for 60 s. Without braking resistor: <ul style="list-style-type: none"> • Drive controllers ≥ ATV31•U22••: 30% of nominal motor torque • Drive controllers ≤ ATV31•U15••: 50% of nominal motor torque • Drive controllers ≤ ATV31•075••: 100% of nominal motor torque • Drive controllers ≤ ATV31•018M2: 150% of nominal motor torque
Frequency resolution	Display: 0.1 Hz Analog inputs: 0.1 Hz to 100 Hz maximum $[(high\ speed - low\ speed)/1024]$
Switching frequency	Adjustable from 2.0 kHz to 16 kHz. Randomly modulated by default, but this can be disabled.
Drive controller protection	Galvanic isolation between power and control (power supplies, inputs, outputs) Protection against short circuits: <ul style="list-style-type: none"> • within internal power supplies • between output phases • between output phases and ground Protection against input phase loss Thermal protection against overheating and overcurrents Undervoltage and overvoltage faults Overbraking fault
Motor protection	Thermal protection, integrated into the drive controller, by I^2t calculation Protection against motor phase loss

Altivar® 31 Adjustable Speed AC Drives

Technical Specifications

Electrical characteristics (continued)

Dielectric strength	<p>Between ground and power terminals: ATV31***M2 and M3X: 2040 Vdc ATV31***N4: 2410 Vdc ATV31***S6X: 2550 Vdc</p> <p>Between control and power terminals: ATV31***M2 and M3X: 2880 Vac ATV31***N4: 3400 Vac ATV31***S6X: 3600 Vac</p>
Resistance to ground	>500 MΩ (electrical isolation) 500 Vdc for 1 minute
Communication	Modbus and CANopen are integrated into the drive controller and available via an RJ45 connector.
Modbus	<p>RS-485 multidrop serial link characteristics:</p> <ul style="list-style-type: none"> • Modbus in RTU mode • Services supported: decimal function codes 03, 06, 16, 23, and 43 • Broadcasting • Number of addresses: drive address can be configured via the local keypad display from 1 to 247 • Maximum number of ATV31 drive controllers: 31 (two 470 Ω master pull-down resistors) • Transmission speed: 4800, 9600, or 19200 bps • The following devices can be connected to the RS-485 link: <ul style="list-style-type: none"> — Remote keypad display — PowerSuite software workstation — PLC — Microprocessor card — PC
CANopen	<p>To connect the ATV31 drive controller to a CANopen network, use the VW3CANTAP2 adapter. The following services are supported:</p> <ul style="list-style-type: none"> • Implicit exchange of Process Data Object (PDO): <ul style="list-style-type: none"> — Two predefined PDOs conforming to DSP 402 Velocity Mode — Two configurable PDOs (data and transmission type) — PDOs can be exchanged between slave devices • Explicit exchange of Service Data Object (SDO): <ul style="list-style-type: none"> — One receive SDO and one transmit SDO • Boot-up messages, emergency messages, node guarding, and producer and consumer heartbeat • Number of addresses: drive controller address can be configured via the integrated terminal from 1 to 127 • Maximum number of drive controllers: 127 • Transmission speed: 10, 20, 50, 125, 250, 500 kbps or 1 Mbps
Codes and standards	<ul style="list-style-type: none"> • UL Listed per UL 508C as incorporating electronic overload protection: UL File E164874 CCN NMMS • CSA Certified to CSA C22.2 No. 14: CSA File LR96921 Class 3211 06 • CE Marked in accordance with the European low voltage (73/23/EEC and 93/68/EEC) and EMC (89/336/EEC) directives • Conforms to applicable NEMA ICS, IEC, NOM, C-TICK, and ISO 9001 standards
Electromagnetic immunity	ATV31 drives meet IEC and EN requirements, the strictest international standards for electrical industrial control devices. They conform to EN 50178, governing electromagnetic compatibility and conducted and radiated emissions.
Electromagnetic compatibility	<ul style="list-style-type: none"> • IEC/EN 61000-4-2 level 3 • IEC/EN 61000-4-3 level 3 • IEC/EN 61000-4-4 level 4 • IEC/EN 61000-4-5 level 3 (power access) • IEC/EN 61800-3, environments 1 and 2
Conducted and radiated emissions for drive controllers (Consult page 16 for additional EMC filters)	<p>All ratings: IEC/EN 61800-3, environments 2 (industrial network) and 1 (public utility network) in limited distribution.</p> <p>ATV31H018M2 to CU40N4:</p> <ul style="list-style-type: none"> • EN 55011, Class A, Group 1; EN 61800-3 Category C2 with additional EMC filter • EN 55022, Class B, Group 1; EN 61800 <p>ATV31HU22M2 to HD15N4:</p> <ul style="list-style-type: none"> • EN 55011, Class A, Group 2; EN 61800-3 Category C3 with additional EMC filter • EN 55022, Class A, Group 1; EN 61800-3 Category C2 • EN 55022, Class B, Group 1; EN 61800-3 Category C1 <p>ATV31H018M3X to HD15M3X with additional EMC filter:</p> <ul style="list-style-type: none"> • EN 55011, Class A, Group 1; EN 61800-3 Category C2 • EN 55022, Class B, Group 1; EN 61800-3 Category C1
Prospective short-circuit current ICC † Refer to "Recommended fuses or Powerpact® circuit breakers" on page 26	<p>ATV31***M2 ≤ 1000 A (ICC at connection point) for single phase power supply ATV31H018M3X...HU40M3X, ATV31•037N4...•U40N4, ATV31H075S6X...HU40S6X ≤ 5000 A (ICC at connection point) for three-phase power supply ATV31HU55M3X...HD15M3X, ATV31HU55N4...HD15N4, ATV31KU55N4...KD15N4, ATV31HU55S6X...HD15S6X ≤ 22000 A (ICC at connection point) for three-phase power supply</p>
Maximum connection capacity and tightening torque of the power supply terminals, motor, braking module, and DC bus	<p>H018M2, H037M2, H055M2, H075M2, H018M3X, H037M3X, H055M3X, H075M3X, HU11M3X, HU15M3X 14 AWG (2.5 mm²), 7.08 lb-in (0.8 N•m)</p> <p>HU11M2, HU15M2, HU22M2, HU22M3X, HU30M3X, HU40M3X, H037N4, H055N4, H075N4, HU11N4, HU15N4, HU22N4, HU30N4, HU40N4, H075S6X, HU15S6X, HU22S6X, HU40S6X 10 AWG (5 mm²), 10.62 lb-in (1.2 N•m)</p> <p>HU55M3X, HU75M3X, HU55N4, HU75N4, HU55S6X, HU75S6X 6 AWG (16 mm²), 19.47 lb-in (2.2 N•m)</p> <p>HD11M3X, HD15M3X, HD11N4, HD15N4, HD11S6X, HD15S6X 3 AWG (25 mm²), 35.40 lb-in (4 N•m)</p>
Electrical isolation	Electrical isolation between power and control (inputs, outputs, power supplies)

Altivar® 31 Adjustable Speed AC Drives

Technical Specifications

Electrical characteristics (continued)

Internal supplies available	Short-circuit and overload protection: One +10 V (-0 / +8%) supply for setpoint potentiometer (2.2 to 10 kΩ), maximum current 10 mA One +24 V supply (minimum 19 V, maximum 30 V) for logic inputs, maximum current 100 mA
Configurable analog inputs Three configurable analog inputs AI1, AI2, AI3.	<p>AI1: Analog input 0 to +10 V (maximum safe voltage is 30 V)</p> <ul style="list-style-type: none"> • Impedance: 30 kΩ • Resolution: 0.01 V, 10-bit converter • Precision: ± 4.3% of maximum value • Linearity: ± 0.2% of maximum value • Sampling time: 8 ms • Shielded cable length: 100 m (328 ft) maximum <p>AI2: Analog input 0 to +10 V (maximum safe voltage is 30 V) Bipolar analog input 0 to ±10 V (maximum safe voltage is ±30 V) <i>The + or - polarity of the voltage on AI2 affects the direction of the setpoint and therefore the direction of rotation.</i></p> <ul style="list-style-type: none"> • Impedance: 30 kΩ • Resolution: 0.01 V, 10-bit + sign converter • Precision: ± 4.3% of maximum value • Linearity: ± 0.2% of maximum value • Sampling time: 8 ms • Shielded cable length: 100 m (328 ft) maximum <p>AI3: Analog input X–Y mA; X and Y programmable from 0–20 mA</p> <ul style="list-style-type: none"> • Impedance: 250 Ω • Resolution: 0.02 mA, 10-bit converter • Precision: ± 4.3% of maximum value • Linearity: ± 0.2% of maximum value • Sampling time: 8 ms
Analog output configurable for voltage, current, or logic output Analog voltage output AOV or Analog current output AOC or Logic voltage output on AOC <i>Can assign either AOV or AOC, but not both.</i>	Analog output 0 to 10 V, minimum load impedance 470 Ω or Analog output X to Y mA; X and Y programmable from 0–20 mA, maximum load impedance 800 Ω <ul style="list-style-type: none"> • Resolution: 8 bits • Precision: ± 1% • Linearity: ± 0.2% • Sampling time: 8 ms or AOC can be configured as a 24 V logic output with a minimum load impedance of 1.2 kΩ
Configurable relay outputs R1A is a N.O. contact. R1B is a N.C. contact. R1C is the common. R1 is programmable—factory set as a fault relay (R1A is closed and R1B is open when the controller is powered with no fault) R2A, R2C N.O. contact of programmable relay R2	<ul style="list-style-type: none"> • Minimum switching capacity: 10 mA for 5 Vdc • Maximum switching capacity on a resistive load (power factor = 1 and L/R time constant = 0 ms): 5 A for 250 Vac and 30 Vdc • Maximum switching capacity on an inductive load (power factor = 0.4 and L/R time constant = 7 ms): 1.5 A for 250 Vac and 30 Vdc • Sampling time: 8 ms • Service life: 100,000 operations at maximum switching power; 1,000,000 operations at minimum switching power
Logic inputs LI LI1, LI2, LI3, LI4, LI5, LI6	Programmable logic inputs <ul style="list-style-type: none"> • +24 V power supply (maximum 30 V) • Impedance: 3.5 kΩ • State 0 if the difference between LIx and CLI is < 5 V, State 1 if the difference between LIx and CLI is > 11 V • Sampling time: 4 ms
Maximum I/O connection capacity and tightening torque	14 AWG (2.5 mm ²) 0.6 N•m (5.31 lb-in)
Acceleration and deceleration ramps	Ramp profiles: <ul style="list-style-type: none"> • linear, can be adjusted separately from 0.1 to 999.9 s • S, U, or customized Automatic adaptation of deceleration ramp time if braking capacities are exceeded, possible inhibition of this adaptation (use of braking resistor).
DC injection braking	DC injection braking can be initiated: <ul style="list-style-type: none"> • By a signal on a programmable logic input • Automatically as soon as the estimated output frequency drops to < 0.5 Hz, period adjustable from 0 to 30 s or continuous, current adjustable from 0 to 1.2 In
Signaling on the drive local keypad display	<ul style="list-style-type: none"> • One red LED indicating the presence of drive voltage • Four 7-segment displays • Two CANopen status LEDs (RUN and ERR)
Scan time for reference change	5 ms

Altivar® 31 Adjustable Speed AC Drives Technical Specifications

Torque characteristics (typical curves)

The torque characteristics curves below define the available continuous torque and transient overtorque for both force-cooled and self-cooled motors. The only difference is in the ability of the motor to provide a high continuous torque at less than half the nominal speed.

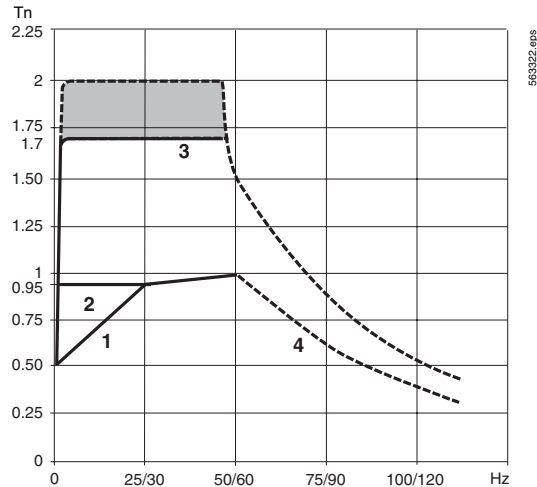

1. Self-cooled motor: continuous useful torque
2. Force-cooled motor: continuous useful torque
3. Transient overtorque 1.7 to 2 T_n
4. Torque in overspeed at constant power¹

Special uses

Using a motor with a different rating than the drive

The drive can supply any motor with a power rating lower than that for which it is designed.

For motors rated slightly higher than the drive, ensure that the load does not exceed the continuous output current of the drive.

Testing on a low power motor or without a motor

In a testing or maintenance environment, the drive can be run without switching to a motor with the same rating as the drive (particularly useful in the case of high power drives). This requires deactivation of motor phase loss detection.

Connecting motors in parallel

The rating of the drive must be greater than or equal to the sum of the currents of the motors connected to the drive.

External thermal protection must be provided for each motor.

If connecting three or more motors in parallel, we recommend installing an output filter between the drive and the motors.

1. The nominal frequency of the motor and the maximum output frequency are adjustable between 40 and 500 Hz.

NOTE: Check the mechanical overspeed characteristics of the selected motor with the manufacturer.

Altivar® 31 Adjustable Speed AC Drives Selection

SELECTION

208 V -15% / 240 V +10% at 50/60 Hz, single-phase input, three-phase output

ATV31 drive Catalog number ¹	Motor Power indicated on nameplate ²		Line supply (input)				Drive controller (output)			
			Max. line current ³		Short- circuit current rating ⁷	Max. inrush current ⁴	Nominal rated output current I _n ²	Transient output current ^{2,5}	Total dissipated power at rated load	
			at 208 V	at 240 V						A
ATV31H018M2	0.18	0.25	3.0	2.5	1	10	1.5	2.3	24	
ATV31H037M2	0.37	0.5	5.3	4.4	1	10	3.3	5.0	41	
ATV31H055M2	0.55	0.75	6.8	5.8	1	10	3.7	5.6	46	
ATV31H075M2	0.75	1	8.9	7.5	1	10	4.8, 4.6, 4.2 ⁶	7.2	60	
ATV31HU11M2	1.1	1.5	12.1	10.2	1	19	6.9	10.4	74	
ATV31HU15M2	1.5	2	15.8	13.3	1	19	8.0	12.0	90	
ATV31HU22M2	2.2	3	21.9	18.4	1	19	11.0	16.5	123	



531248-10-M1if

ATV31H037M2

208 V -15% / 240 V +10% at 50/60 Hz, three-phase input, three-phase output

ATV31 drive Catalog number ¹	Motor Power indicated on nameplate ²		Line supply (input)				Drive controller (output)			
			Max. line current ³		Short- circuit current rating ⁷	Max. inrush current ⁴	Nominal rated output current I _n ²	Transient output current ^{2,5}	Total dissipated power at rated load	
			at 208 V	at 240 V						A
ATV31H018M3X	0.18	0.25	2.1	1.9	5	10	1.5	2.3	23	
ATV31H037M3X	0.37	0.5	3.8	3.3	5	10	3.3	5.0	38	
ATV31H055M3X	0.55	0.75	4.9	4.2	5	10	3.7	5.6	43	
ATV31H075M3X	0.75	1	6.4	5.6	5	10	4.8	7.2	55	
ATV31HU11M3X	1.1	1.5	8.5	7.4	5	10	6.9	10.4	71	
ATV31HU15M3X	1.5	2	11.1	9.6	5	10	8.0	12.0	86	
ATV31HU22M3X	2.2	3	14.9	13.0	5	10	11.0	16.5	114	
ATV31HU30M3X	3	3	19.1	16.6	5	19	13.7	20.6	146	
ATV31HU40M3X	4	5	24.2	21.1	5	19	17.5	26.3	180	
ATV31HU55M3X	5.5	7.5	36.8	32.0	22	23	27.5	41.3	292	
ATV31HU75M3X	7.5	10	46.8	40.9	22	23	33.0	49.5	388	
ATV31HD11M3X	11	15	63.5	55.6	22	93	54.0	81.0	477	
ATV31HD15M3X	15	20	82.1	71.9	22	93	66.0	99.0	628	



531249-15-M1if

ATV31HU40MX3

- 1) For a drive equipped with a control potentiometer and with run and stop buttons, add an "A" at the end of the catalog number (for example, ATV31HO37N4A). This option is not available for 575 V controllers.
- 2) These power ratings and currents are for a maximum ambient temperature of 50 °C (122 °F) and a switching frequency of 4 kHz in continuous operation. The switching frequency is adjustable from 2 to 16 kHz. Above 4 kHz, the drive controller reduces the switching frequency in the event of excessive temperature rise. The temperature rise is controlled by a PTC probe in the power module. Derate the nominal current if continuous operation above 4 kHz is required. Derating curves are shown on page 30 as a function of switching frequency, ambient temperature, and mounting conditions.
- 3) Current on a line supply with the indicated short-circuit current rating.
- 4) Peak current on power-up, for the maximum voltage (240 V +10%).
- 5) For 60 seconds.
- 6) 4.8 A at 200 V, 4.6 A at 208 V, 4.2 A at 240 V.
- 7) Refer to "Recommended fuses or Powerpact® circuit breakers" on page 26.

Altivar® 31 Adjustable Speed AC Drives Selection

400 V -15% / 460 V +15% at 50/60 Hz, three-phase input, three-phase output



ES 1250-20-A110

ATV31 drive Catalog number ²	Motor		Line supply (input)				Drive controller (output)		
	Power indicated on nameplate ³		Max. line current ⁴		Short-circuit current rating ⁷	Max. inrush current ⁵	Nominal rated output current I _n ^{3,6}	Max. transient current ^{3,6}	Total dissipated power at rated load
	kW	hp	at 400 V A	at 460 V A					
ATV31H037N4	0.37	0.5	2.2	1.7	5	10	1.5	2.3	32
ATV31H055N4	0.55	0.75	2.8	2.2	5	10	1.9	2.9	37
ATV31H075N4	0.75	1	3.6	2.7	5	10	2.3	3.5	41
ATV31HU11N4	1.1	1.5	4.9	3.7	5	10	3.0	4.5	48
ATV31HU15N4	1.5	2	6.4	4.8	5	10	4.1	6.2	61
ATV31HU22N4	2.2	3	8.9	6.7	5	10	5.5	8.3	79
ATV31HU30N4	3	3	10.9	8.3	5	10	7.1	10.7	125
ATV31HU40N4	4	5	13.9	10.6	5	10	9.5	14.3	150
ATV31HU55N4	5.5	7.5	21.9	16.5	22	30	14.3	21.5	232
ATV31HU75N4	7.5	10	27.7	21.0	22	30	17.0	25.5	269
ATV31HD11N4	11	15	37.2	28.4	22	97	27.7	41.6	397
ATV31HD15N4	15	20	48.2	36.8	22	97	33.0	49.5	492

525 V -15% / 575 V +15% at 50/60 Hz, three-phase input, three-phase output ¹

ATV31 drive Catalog number ²	Motor		Line supply (input)				Drive controller (output)		
	Power indicated on nameplate ³		Max. line current ⁴		Short-circuit current rating ⁷	Max. inrush current ⁵	Nominal rated output current I _n ^{3,6}	Max. transient current ^{3,6}	Total dissipated power at rated load
	kW	hp	at 525 V A	at 600 V A					
ATV31H075S6X	0.75	1	2.8	2.4	5	12	1.7	2.6	36
ATV31HU15S6X	1.5	2	4.8	4.2	5	12	2.7	4.1	48
ATV31HU22S6X	2.2	3	6.4	5.6	5	12	3.9	5.9	62
ATV31HU40S6X	4	5	10.7	9.3	5	12	6.1	9.2	94
ATV31HU55S6X	5.5	7.5	16.2	14.1	22	36	9.0	13.5	133
ATV31HU75S6X	7.5	10	21.3	18.5	22	36	11.0	16.5	165
ATV31HD11S6X	11	15	27.8	24.4	22	117	17.0	25.5	257
ATV31HD15S6X	15	20	36.4	31.8	22	117	22.0	33.0	335

- 1) A 3% line reactor is required for all 575 V drive controller installations.
- 2) For a drive equipped with a control potentiometer and with run and stop buttons, add an "A" at the end of the catalog number (for example, ATV31H037N4A). This option is not available for 575 V controllers.
- 3) These power ratings and currents are for a maximum ambient temperature of 50 °C (122 °F) and a switching frequency of 4 kHz in continuous operation. The switching frequency is adjustable from 2 to 16 kHz. Above 4 kHz, the drive controller reduces the switching frequency in the event of excessive temperature rise. The temperature rise is controlled by a PTC probe in the power module. Derate the nominal current if continuous operation above 4 kHz is required. Derating curves are shown on page 30 as a function of switching frequency, ambient temperature, and mounting conditions.
- 4) Current on a line supply with the indicated short-circuit current rating.
- 5) Peak current on power-up, for the maximum voltage (460 Vac/575 Vac +15%).
- 6) For 60 seconds.
- 7) Refer to "Recommended fuses or Powerpact® circuit breakers" on page 26.

Altivar® 31 Adjustable Speed AC Drives Accessories



VW3A31852



VW3A3181•

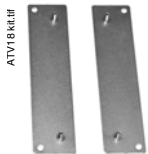

VW3A31101

ACCESSORIES

DIN rail mounting plate

Description	For drives ATV31••••••	Catalog number	Weight kg (lb)
Plate for mounting on DIN rail, width 35 mm	Frame sizes 1–4 H018M2, H037M2, H055M2, H075M2, H018M3X, H037M3X, H055M3X, H075M3X	VW3A31851	0.200 (0.44)
	Frame sizes 5–6 HU11M2, HU15M2, HU11M3X, HU15M3X, HU22M3X, H037N4, H055N4, H075N4, HU11N4, HU15N4, H075S6X, HU15S6X	VW3A31852	0.220 (0.49)

UL Type 1 conduit entrance kit ¹⁾

Description	For drives ATV31••••••	Catalog number	Weight kg (lb)
Mechanical device attaching to the bottom of the ATV31 drive	H018M2, H037M2, H055M2, H075M2	VW3A31812	0.400 (0.88)
	H018M3X, H037M3X, H055M3X, H075M3X	VW3A31811	0.400 (0.88)
	HU11M3X, HU15M3X	VW3A31813	0.400 (0.88)
	HU11M2, HU15M2, HU22M3X, H037N4, H055N4, H075N4, HU11N4, HU15N4, H075S6X, HU15S6X	VW3A31814	0.500 (1.10)
	HU22M2, HU30M3X, HU40M3X, HU22N4, HU30N4, HU40N4, HU22S6X, HU40S6X	VW3A31815	0.500 (1.10)
	HU55M3X, HU75M3X, HU55N4, HU75N4, HU55S6X, HU75S6X	VW3A31816	0.900 (1.98)
	HD11M3X, HD15M3X, HD11N4, HD15N4, HD11S6X, HD15S6X	VW3A31817	1.200 (2.65)

¹⁾ This device allows cables to be connected directly to the drive using conduits or cable glands.

ATV28 replacement kit

Frame size	For Drives ATV31••••••	Catalog number	Weight kg (lb)
1–4	H018M3X, H037M3X, H055M3X, H075M3X, H018M2, H037M2, H055M2, H075M2	VW3A31821	0.227 (0.50)
5–6	HU11M2, HU15M2, HU11M3X, HU15M3X, HU22M3X, H037N4, H055N4, H075N4, HU11N4, HU15N4, H075S6X, HU15S6X	VW3A31822	0.255 (0.56)
7	HU22M2, HU30M3X, HU40M3X, HU22N4, HU30N4, HU40N4, HU22S6X, HU40S6X	VW3A31824	0.591 (1.30)
8	HU55M3X, HU75M3X, HU55N4, HU75N4, HU55S6X, HU75S6X	VW3A31823	0.223 (0.49)
9	HD11M3X, HD15M3X, HD11N4, HD15N4, HD11S6X, HD15S6X	VW3A31825	0.445 (0.98)

Remote keypad display

Description	Catalog number	Weight kg (lb)
For ATV31 drives of all ratings. Assembly includes: <ul style="list-style-type: none"> keypad display, cable fitted with two connectors seal and screws for IP65 mounting on an enclosure door 	VW3A31101	0.377 (0.83)

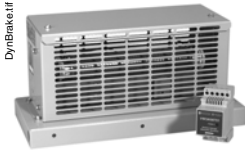

DYNAMIC BRAKING RESISTOR KITS

The dynamic braking resistor kit allows the ATV31 drive controllers to function in quadrants 2 and 4 of the four-quadrant speed/torque curve. In these quadrants of motor operation, the motor is essentially a generator through which energy is transferred from the motor load back to the drive controller. This results in elevated DC bus voltage to the drive controller, which can cause it to shut down to protect itself. Dynamic braking resistor kits are commonly used to dissipate the excess energy generated by the motor operating in this mode. The flow of current to the braking resistor is controlled by the dynamic braking transistor. Applications include machines with high inertia, overhauling loads, and machines with fast cycles.

The following table shows the minimum ohmic value of the resistor that can be used with the ATV31 drive controllers. Using lower than recommended values will cause excessive current flow, exceeding the rating of the dynamic braking transistor.

Minimum dynamic braking resistance values

240 V single-phase drive catalog no.	PA / PB minimum resistance Ω	240 V three-phase drive catalog no.	PA / PB minimum resistance Ω	460 V three-phase drive catalog no.	PA / PB minimum resistance Ω	575 V three-phase drive catalog no.	PA / PB minimum resistance Ω
ATV31H018M2	40	ATV31H018M3X	40	ATV31H037N4	80	ATV31H075S6X	96
ATV31H037M2		ATV31H037M3X		ATV31H055N4		ATV31HU15S6X	64
ATV31H055M2	40	ATV31H055M3X	40	ATV31H075N4	80	ATV31HU22S6X	65
ATV31H075M2		ATV31H075M3X		ATV31HU11N4		54	
ATV31HU11M2	27	ATV31HU11M3X	27	ATV31HU15N4	54	ATV31HU40S6X	34
ATV31HU15M2		ATV31HU15M3X		ATV31HU22N4		54	ATV31HU55S6X
ATV31HU22M2	25	ATV31HU22M3X	25	ATV31HU30N4	55	ATV31HU75S6X	24
		ATV31HU30M3X		ATV31HU40N4		36	
		ATV31HU40M3X	16	ATV31HU55N4	29	ATV31HU15S6X	
		ATV31HU55M3X	8	ATV31HU75N4	19		
		ATV31HU75M3X	8	ATV31HD11N4	20		
		ATV31HU11M3X	5	ATV31HD15N4			
		ATV31HU15M3X					

The following charts show the motor braking torque capacity of an ATV31 drive controller with a braking resistor.

Braking torque with resistor

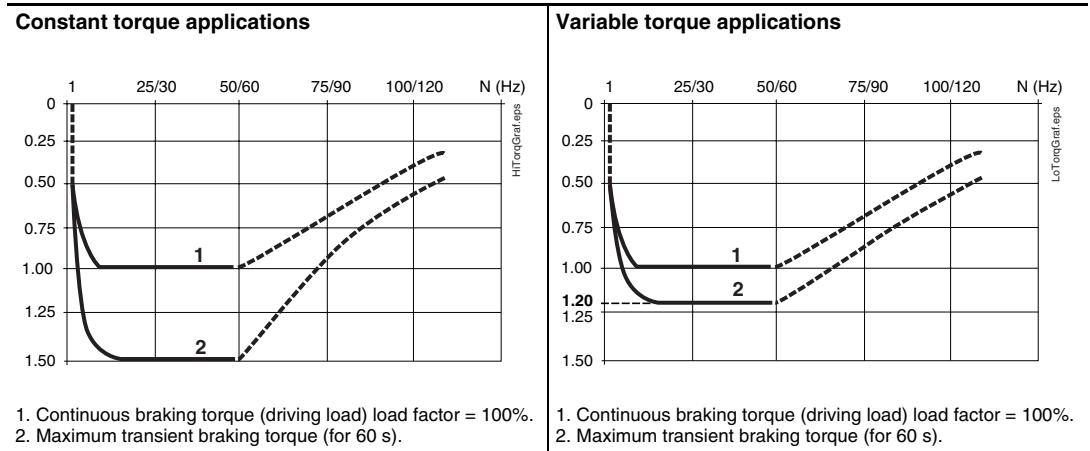

Altivar® 31 Adjustable Speed AC Drives Dynamic Braking Resistor Kits

Calculating resistor size

The standard dynamic braking (DB) resistor assemblies are suited to a wide variety of drive system stopping applications. However, where the driven machinery can present an overhauling load or large inertia to the drive system, the suitability of the DB resistor assembly must be verified.

The suitability of a DB resistor assembly is determined by analyzing the mechanical system of the driven machinery. From the analysis, the following key parameters are computed:

- The peak braking power required during stopping or speed changes (P_i). The value of P_i determines the maximum allowable ohmic value of the DB resistor.
- The amount of power that must be absorbed (P_d) for a given time (t_d) by the DB resistors during stopping or speed changes of the drive. The value of P_d and t_d determine the required time-current characteristic of the DB resistor.
- The calculation of dynamic braking power requires V_{db} .
 - **575 V drives:** $V_{db} = 1020 \text{ V}$
 - **460 V drives:** $V_{db} = 850 \text{ V}$
 - **230 V drives:** $V_{db} = 375 \text{ V}$
- The average power that must be dissipated by the DB resistor during an entire cycle of the machine (P_a). The value of P_a determines the required continuous current rating of the DB resistor.

The following example illustrates the process.

Given:

The application consists of a 5 hp, 460 Vac, 1740 rpm motor (N_{base} = base speed) with a rotor inertia of 0.28 lb-ft². The motor is being controlled by an ATV31HU40N4 operating in the constant torque mode. The motor is driving a machine with an inertia 10 times that of the motor with no interposing gear box. The machine resistive (friction) torque is one-tenth of the rated motor torque at full speed. The requirement is to stop in 5 seconds from rated speed at a rate of 2 cycles/minute.

Mechanical System Parameters:

Rated motor torque: $T_n = (hp \times 5250) / N_{base} = (5 \times 5250) / 1740 = 15.1 \text{ lb-ft}$

Machine cycle time: $t_c = (60 \text{ seconds}) / (\text{two operations per minute}) = 30 \text{ seconds}$

Machine speed change during deceleration: $N_d = 1740 \text{ rpm} - 0 \text{ rpm} = 1740 \text{ rpm}$

Machine deceleration time: $t_d = 5 \text{ seconds}$

Mechanical system resistive (friction) torque: $T_r = (15.1 \text{ lb-ft}) / 10 = 1.51 \text{ lb-ft}$

Mechanical system overhauling torque: $T_o = 0.00 \text{ lb-ft}$

Mechanical system combined inertia: $J_c = 0.28 \text{ lb-ft}^2 + (10 \times 0.28 \text{ lb-ft}^2) = 3.08 \text{ lb-ft}^2$

Mechanical system inertial torque for a 5 second deceleration rate (as set by controller deceleration ramp):

$T_j = J_c \times [N_d / (308 \times t_d)] = 3.08 \times [1740 / (308 \times 5)] = 3.48 \text{ lb-ft}$

Required braking torque from motor: $T_b = T_j + T_o - T_r = 3.48 + 0.00 - 1.51 = 1.97 \text{ lb-ft}$

NOTE: The required braking torque must not exceed the motor's ability to produce torque. For inertial loads, including those depicted in the above examples, the required braking torque must not exceed the torque-producing ability of the dynamic braking unit with the recommended braking resistor (approximately 1.5 times the motor rated torque for constant torque applications).

For machines that can continuously overhaul the motor, the value of overhauling torque (T_o) minus the resistive torque (T_r) must not exceed the motor continuous torque rating at any speed.

Altivar® 31 Adjustable Speed AC Drives Dynamic Braking Resistor Kits

DB resistor requirements:

Peak braking power required to develop braking torque (T_b) when decelerating from a given speed:
 $P_i = (T_b \times N_{base})/7.04 = (1.97 \times 1740)/7.04 = 487 \text{ W}$

The braking power that must be absorbed for a time (t_d) during a stop or speed change operation:
 $P_d = 0.5 \times P_i = 0.5 \times 487 = 243 \text{ W for a period of } t_d \text{ seconds}$

The average braking power that must be dissipated during a machine cycle:
 $P_a = P_d \times t_d/t_c = 243 \times 5/30 = 40.5 \text{ W}$

Capability of VW3A66711 DB resistor assembly for ATV31HU40N4 controller:

Peak braking power that can be developed with the VW3A66711 DB resistor assembly with the controller configured for 460 Vac input line operation: $P_i = (V_{db})^2/R_{db} = (850 \text{ V})^2/120 \Omega = 6020 \text{ W}$

The braking power that can be absorbed for t_d (based on the DB resistor hot state current-time characteristic curve shown below):

$$P_d = R_{db} \times [(Multiple\ of\ I_r\ at\ t_d) \times I_r]^2 = 120 \Omega \times (3.5 \times 1.0)^2 = 1470 \text{ W}$$

Since R_{db} limits the peak current that can be drawn from the drive controller DC bus, the value of $[(Multiple\ of\ I_r) \times I_r]$ must be limited to no greater than $(\sqrt{P_i/R_{db}})$.

The average braking power that can be dissipated continuously:

$$P_a = R_{db} \times (I_r)^2 = 120 \Omega \times (1)^2 = 120 \text{ W}$$

For this example, the VW3A66711 DB resistor assembly will work as intended for the application.

Current/time characteristics for DB resistor assemblies

The figure below shows the allowable trip times¹ as a function of current setting multiples with the dynamic braking resistor assembly located in a 40 °C (104 °F) ambient temperature environment. See “Calculating resistor size” on page 14 for an example of how to calculate resistor size.

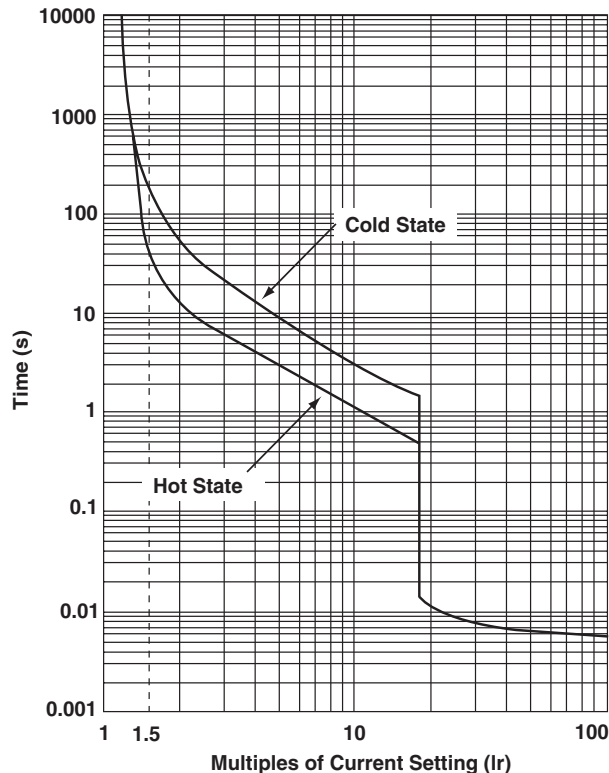

1. Of the GV2 manual starter; see page 16.

Altivar® 31 Adjustable Speed AC Drives

Additional EMC Input Filters

The kits in the following table use the thermal protection of a GV2 manual starter and have a Type 1 rating per UL 50. The insulation system is suitable for use in a Pollution Degree 3 environment (refer to NEMA ICS-1 Annex A). The package is UL/CSA marked.

Dynamic braking resistor kits technical specifications

Drive controller catalog number	Ohmic Value (Rdb) Ω	Continuous Current Rating of Assembly (I _r) A	Average Power W	Kit catalog number
ATV31H018M2-037M2 ATV31H018M3X-037M3X ATV31H037N4-U40N4	120	1.00	120	VW3A66711
ATV31H055M2-U22M2 ATV31H055M3X-U22M3X ATV31HU55N4-U75N4	56	1.45	118	VW3A66712
ATV31HU30M3X-U40M3X ATV31HD11N4-D15N4	28	2.70	204	VW3A66713
ATV31HU55M3X-U75M3X	14	3.80	202	VW3A66714
ATV31HD11M3X-D15M3X	10	10.00	1000	VW3A66715



ADDITIONAL EMC INPUT FILTERS

Function

The ATV31 drive has built-in radio frequency interference (RFI) input filters to meet EMC “product” standards for adjustable speed drives, IEC/EN 61800-3, and to comply with the European EMC (electromagnetic compatibility) directive.

The additional filters enable the drives to meet more stringent requirements: they are designed to reduce conducted emissions on the line supply below the limits of standards EN 55011 class A (1) or EN 55022 class B. These filters mount beneath ATV31H drives via tapped holes, acting as supports for the drives.

Considerations for isolated or impedance grounded neutral systems

The standard IEC 61800-3, annex D2.1, indicates that on isolated or impedance grounded neutral systems, the filters can affect the operation of insulation monitors.

The efficiency of additional filters on this type of system also depends on the nature of the impedance between neutral and earth and is therefore unpredictable.

If installing a machine on an isolated or impedance grounded neutral system, one solution is to insert an isolation transformer and connect locally to the machine on a neutral connection or neutral-to-earth system.

Characteristics

Conformity to standards		EN 133200
Degree of protection		IP 21 and IP 41 on upper part
Maximum relative humidity		93% without condensation or dripping water conforming to IEC 68-2-3
Ambient air temperature around the device	Operation	-10 to +60 °C (14 to +140 °F)
	Storage	-25 to +70 °C (-13 to +158 °F)
Maximum operating altitude	Without derating	1000 m (3281 ft). At higher elevations, derate the current by 1% per additional 100 m (328 ft).
Vibration resistance	Conforming to IEC 60068-2-6	1.5 mm peak to peak from 3 to 13 Hz 1 gn peak from 13 to 150 Hz
Shock resistance	Conforming to IEC 60068-2-27	15 gn for 11 ms
Maximum nominal voltage	50/60 Hz single phase	240 V +10%
	50/60 Hz three-phase	240 V +10% 500 V +10% 600 V +10%

Altivar® 31 Adjustable Speed AC Drives Additional EMC Input Filters

EMC filters



Drive catalog number	Maximum length of shielded cable ¹		I _n ² A	I _{ll} ³ mA	Filter catalog number	Weight kg (lb)
	EN 55011 Class A m (ft)	EN 55022 Class B m (ft)				
Single phase supply voltage: 200/240 V 50/60 Hz						
ATV31H018M2	50 (164)	20 (66)	9	100	VW3A31401	0.600 (1.323)
ATV31H037M2						
ATV31H055M2						
ATV31H075M2						
ATV31HU11M2	50 (164)	20 (66)	16	150	VW3A31403	0.775 (1.709)
ATV31HU15M2						
ATV31HU22M2						
ATV31HU22M2	50 (164)	20 (66)	22	80	VW3A31405	1.130 (2.491)
Three-phase supply voltage: 200/240 V 50/60 Hz						
ATV31H018M3X	5 (16)	—	7	7	VW3A31402	0.650 (1.433)
ATV31H037M3X						
ATV31H055M3X						
ATV31H075M3X						
ATV31HU11M3X	5 (16)	—	15	15	VW3A31404	1.000 (2.205)
ATV31HU15M3X						
ATV31HU22M3X						
ATV31HU30M3X	5 (16)	—	25	35	VW3A31406	1.650 (3.638)
ATV31HU40M3X						
ATV31HU55M3X	5 (16)	—	47	45	VW3A31407	3.150 (6.945)
ATV31HU75M3X						
ATV31HD11M3X	5 (16)	—	83	15	VW3A31408	5.300 (11.684)
ATV31HD15M3X						
Three-phase supply voltage: 380/500 V 50/60 Hz						
ATV31H037N4	50 (164)	20 (66)	15	15	VW3A31404	1.000 (2.205)
ATV31H055N4						
ATV31H075N4						
ATV31HU11N4						
ATV31HU15N4						
ATV31HU22N4	50 (164)	20 (66)	25	35	VW3A31406	1.650 (3.638)
ATV31HU30N4						
ATV31HU40N4						
ATV31HU55N4	50 (164)	20 (66)	47	45	VW3A31407	3.150 (6.945)
ATV31HU75N4						
ATV31HD11N4	50 (164)	20 (66)	49	45	VW3A31409	4.750 (10.472)
ATV31HD15N4						

¹⁾ For a switching frequency of 2 to 16 kHz. These limits are given as examples only, as they vary depending on the interference capacity of the motors and the cables used. If motors are connected in parallel, it is the total length that should be considered.

²⁾ I_n: Nominal filter current.

³⁾ Maximum earth leakage current at 50 Hz.

Altivar® 31 Adjustable Speed AC Drives Communication Options

COMMUNICATION OPTIONS

The communication option provides access to the drive's configuration, adjustment, control, and monitoring functions.

Modbus and CANopen communication

The ATV31 drive can connect directly to Modbus and CANopen buses via an RJ45 connector, which supports both protocols.

CANopen

Connection diagram

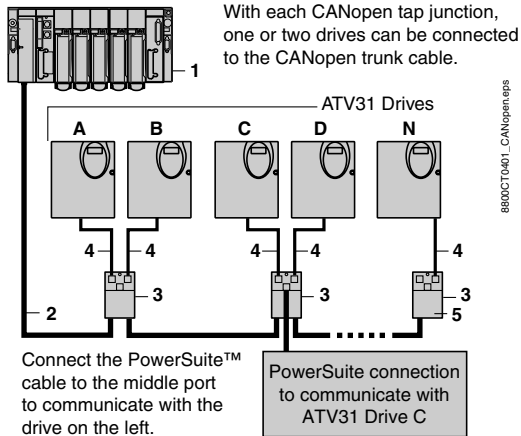

1. PLC ¹
2. CANopen trunk cable
3. CANopen tap junction **VW3CANTAP2**
4. CANopen drop cable **VW3CANCARR••**
5. Internal terminator switched on in the last tap.

¹⁾ Consult the Telemecanique PLC catalogs.

Modbus

Connections via splitter blocks and RJ45 connectors

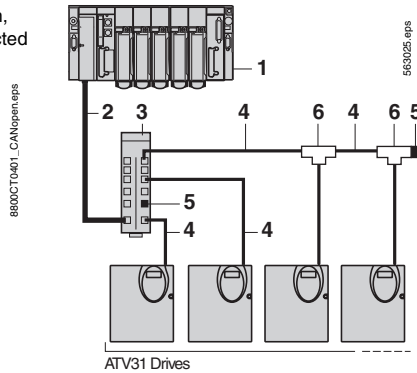

1. PLC ¹
2. Modbus cable (depending on the type of controller or PLC)
3. Modbus splitter block **LU9 GC3**
4. Modbus drop cables **VW3A8306R••**
5. Line terminators **VW3A8306RC**
6. Modbus T-junction boxes **VW3A8306TF••** (with cable)

Connections via screw terminals

Use a Modbus drop cable **VW3A8306D30** and line terminators **VW3A8306DRC**.

Connections via junction boxes

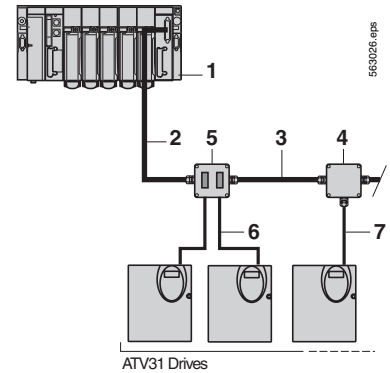

1. PLC ¹
2. Modbus cable (depending on the type of controller or PLC)
3. Modbus cables **TSXCSA•00**
4. T-junction box **TSXSCA50**
5. Subscriber socket **TSXSCA62**
6. Modbus drop cables **VW3A8306**
7. Modbus drop cables **VW3A8306D30**

NOTE: The ATV31 drive does not contain bias resistors. If the PLC does not have internal bias resistors, then external resistors may be necessary.

Other communication devices

The ATV31 drive can also connect to the following networks via a module (bridge or gateway):

- Ethernet
- Fipio
- Profibus DP
- DeviceNet

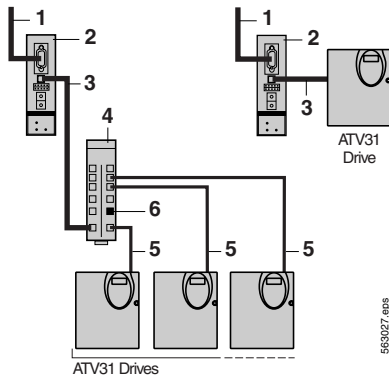

1. To network
2. Communication modules
3. Cables **VW3A8306R••**, **VW3P07306R10** or **VW3A8306D30**, depending on the type of communication module.
4. Modbus splitter block **LU9GC3**
5. Modbus drop cables **VW3A8306R••**
6. Line terminator **VW3A8306RC**

Altivar® 31 Adjustable Speed AC Drives Communication Options

Modbus and CANopen communication

Connection accessories

Description	Catalog number	Weight kg (lb)		
CANopen bus junction box	VW3CANTAP2	—		
Modbus junction box 3 screw terminals, RC line terminator Connects using cable VW3A8306D30	TSXSACA50	0.520 (1.15)		
Modbus subscriber socket Two female 15-way SUB-D connectors and two screw terminals, RC line terminator Connects using cable VW3A8306	TSXSACA62	0.570 1.26)		
Modbus splitter block Ten RJ45 connectors and one screw terminal	LU9GC3	0.500 (1.10)		
Modbus line terminators ¹	For RJ45 connector	R = 120 Ω, C = 1 nF	VW3A8306RC	0.200 (0.44)
		R = 150 Ω	VW3A8306R	0.200 (0.44)
	For screw terminals	R = 120 Ω, C = 1 nF	VW3A8306DRC	0.200 (0.44)
		R = 150 Ω	VW3A8306DR	0.200 (0.44)
Modbus T-junction boxes	With integrated cable (0.3 m / 1.0 ft)	VW3A8306TF03	—	
	With integrated cable (1.0 m / 3.3 ft)	VW3A8306TF10	—	

Connecting cables

Description	Length m (ft)	Connectors	Catalog number	Weight kg (lb)
Cables for CANopen bus	0.3 (1.0)	2 RJ45 connectors	VW3CANCARR03	0.050 (0.11)
	1.0 (3.28)	2 RJ45 connectors	VW3CANCARR1	0.500 (1.10)
Cables for Modbus bus	3.0 (9.8)	1 RJ45 connector and one end stripped	VW3A8306D30	0.150 (0.33)
	3.0 (9.8)	1 RJ45 connector and 1 male 15-way SUB-D connector for TSXSACA62	VW3A8306	0.150 (0.33)
	0.3 (1.0)	2 RJ45 connectors	VW3A8306R03	0.050 (0.11)
	1.0 (3.3)	2 RJ45 connectors	VW3A8306R10	0.050 (0.11)
	3.0 (9.8)	2 RJ45 connectors	VW3A8306R30	0.150 (0.33)
	Cables for Profibus gateway LA9P307	1.0 (3.3)	2 RJ45 connectors	VW3P07306R10
RS-485 double shielded twisted pair cables	100 (328)	Supplied without connector	TSXCSA100	—
	200 (656)	Supplied without connector	TSXCSA200	—
	500 (1640)	Supplied without connector	TSXCSA500	—

Other communication devices

Description	Connecting cables	Catalog number	Weight kg (lb)
Ethernet/Modbus bridge ² with 1 x Ethernet 10baseT port (RJ45)	VW3A8306D30	174CEV30020	0.500 (1.10)
Fipio/Modbus gateway	VW3A8306R**	LUFP1	0.240 (0.53)
DeviceNet/Modbus gateway	VW3A8306R**	LUFP9	0.240 (0.53)
Profibus DP/Modbus gateway Parameters set using ABC Configurator software	VW3A8306R**	LUFP7	0.240 (0.53)
Modbus hub Eight RJ45 ports		LU9GC3	0.208 (0.46)

- 1) Sold in lots of two.
- 2) Consult the catalog, *Premium Automation Platform*.



TSX SCA 50



TSX SCA 62



174 CEV 300 20



LUFP1



LA9P307

Altivar® 31 Adjustable Speed AC Drives PowerSuite™ Software

POWERSUITE™ SOFTWARE

Description

The PowerSuite software workshop for PC or Pocket PC is designed for setting up Telemecanique® starters and adjustable speed drives.

This single program is an easy-to-use interface for configuring Altistart and TeSys® U starters as well as all Altivar drives in a Microsoft® Windows® environment, in five languages: English, Spanish, French, German, and Italian. PowerSuite software also has on-line contextual help.

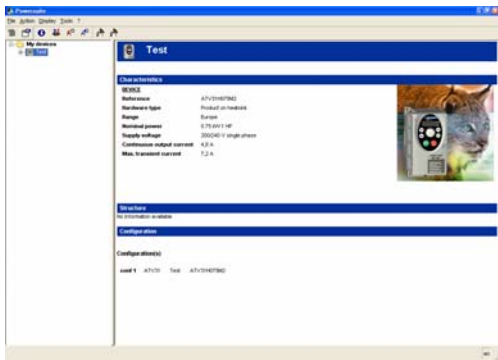

PowerSuite software for PC screen—Characteristics

Function

PowerSuite software allows you to prepare, program, set up, and maintain Telemecanique starters and adjustable speed drives in either of two modes:

- Stand alone, to prepare and store starter or drive configuration files
- Connected to the starter or drive, to:
 - configure the initial setup
 - adjust the parameters
 - monitor and control operation (except for Altivar 11 drives)
 - transfer and compare configuration files between PowerSuite software and the controller

PowerSuite software generates configuration files that can be:

- saved to hard disk or removable media such as CD-ROM or floppy disk
- printed
- exported to office automation software applications
- protected using a password
- exchanged between a PC and a Pocket PC using standard synchronization software (configuration files for PC and Pocket PC have the same format)

Enhancements to the software associated with the ATV31 drive include:

- oscilloscope function
- parameter name customization
- creation of a user menu
- creation of monitoring screens
- searching and sorting on different parameters

Connections

- When using the serial port on the PC or Pocket PC, PowerSuite software can connect directly to the terminal port on the starter or adjustable speed drive.
 - **Point-to-point connection:** with a single starter or drive
 - **Multi-point connection:** with a group of starters or drives
- When connected to an Ethernet network, PowerSuite software for PC can access the starters and drives using either:
 - the Ethernet-Modbus bridge, catalog number 174CEV30020 (see page 19)
 - the communication option card, catalog number VW3A58310, for Altivar 58 (ATV58) drives only

Hardware and software environment

- PowerSuite software for PC can operate in the following PC environments and configurations:
 - Microsoft Windows 95 OSR2, Windows 98 SE, Windows NT4 X SP5, Windows Me, Windows 2000, Windows XP
 - Pentium III, 800 MHz, hard disk with 300 Mb available, 128 Mb RAM
 - SVGA or higher definition monitor
- PowerSuite software for Pocket PC, version V2.0.0, is compatible with Pocket PCs equipped with Windows for Pocket PC 2002 or 2003 operating system and an ARM or XSCALE processor. Version V2.0.0 of PowerSuite software has been performance-tested on the following Pocket PCs:
 - Hewlett Packard® IPAQ 2210
 - Compaq® IPAQ series 3800 and 3900
 - Hewlett Packard Jornada series 560

Catalog numbers

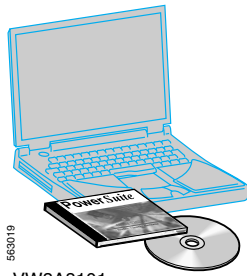

VW3A8101

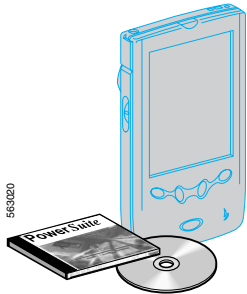

VW3A8102

PowerSuite software workshop for PC or Pocket PC ¹

Description	Contents	Catalog number	Weight kg (lb)
PowerSuite CD-ROM	<ul style="list-style-type: none"> Software for PC and Pocket PC ⁴ Technical documentation and ABC configurator program 	VW3A8104	0.100 (0.22)
PowerSuite upgrade CD	<ul style="list-style-type: none"> Software for PC and Pocket PC ⁴ Technical documentation and ABC configurator program 	VW3A8105	0.100 (0.22)
PC connection kit	<ul style="list-style-type: none"> Two 3 m (9.8 ft) connection cables with two RJ45 connectors One RJ45/9-way SUB-D adapter for connecting ATV58 drives One converter marked RS-232/RS-485 PC with one 9-way female SUB-D connector and one RJ45 connector One converter for ATV11 drives with one 4-way male connector and one RJ45 connector 	VW3A8106	0.350 (0.77)
Pocket PC connection kit ²	<ul style="list-style-type: none"> Two 0.6 m (2.0 ft) connection cables with two RJ45 connectors One RJ45/9-way SUB-D adapter for connecting ATV58 drives One converter marked RS-232/RS-485 PPC with one 9-way male SUB-D connector and one RJ45 connector One converter for ATV11 drives with one 4-way male connector and one RJ45 connector 	VW3A8111	0.300 (0.66)
Modbus-Bluetooth® adapter ³	<ul style="list-style-type: none"> One Bluetooth adapter (10 m range, class 2) with one RJ45 connector One 0.1 m cable with two RJ45 connectors for PowerSuite One 0.1 m cable with 1 RJ45 connector and one mini DIN connector for TwidoSoft 1 RJ45/9-way SUB-D adapter for connecting ATV58 TRX and Type FVC drives 	VW3A8114	0.155 (0.34)
USB-Bluetooth adapter for PC	One adapter for connecting to a USB port on a PC not equipped with Bluetooth technology. Range is 10 m (class 2).	VW3A8115	0.290 (0.64)

1) For information on the latest available version, consult your local sales office.

2) These kits connect to the synchronization cable, which must be ordered separately from your Pocket PC supplier.

3) Also used to communicate between a Twido PLC and the TwidoSoft software workshop.

4) In English, Spanish, French, German, and Italian.

Compatibility with starters and drives

Connection	Starter-controller	Soft starter	Adjustable speed drives				
	TeSys U-Line	ATS48	ATV11	ATV31	ATV58 TRX	ATV58 Type FVC	ATV71
PowerSuite software workshop for PC							
Modbus serial link (ATV68: specific protocol)	≥ V1.40	≥ V1.30	≥ V1.40	≥ V2.0	≥ V1.40	≥ V1.0	≥ V2.2
Ethernet (using the Ethernet TCP/IP card)	—	—	—	—	≥ V1.50	≥ V1.50	≥ V2.2
Ethernet (using the Ethernet/Modbus bridge)	—	≥ V1.50	—	≥ V2.0	≥ V1.50	≥ V1.50	≥ V2.2
Bluetooth adapter	≥ V2.2	≥ V2.2	—	≥ V2.2	≥ V2.2	≥ V2.2	≥ V2.2
PowerSuite software workshop for Pocket PC							
Modbus serial link	≥ V1.50	≥ V1.30	≥ V1.40	≥ V2.0	≥ V1.40	≥ V1.20	—

Compatibility with Pocket PCs

Connection	Operating system	Pocket PC	PowerSuite software version			
			V2.0	V1.50	V1.40	V1.30
Modbus serial link	Windows Mobile™ 2003 for Pocket PC	Hewlett Packard® IPAQ 2210	Yes	—	—	—
	Windows® for Pocket PC 2002	Compaq® IPAQ series 3800, 3900	Yes	Yes	—	—
		Hewlett Packard Jornada series 560	Yes	Yes	Yes	—
	Windows for Pocket PC 2000	Hewlett Packard Jornada 525, 545, 548	—	Yes	Yes	Yes
Windows CE	Hewlett Packard Jornada 420	—	—	—	Yes	

Altivar® 31 Adjustable Speed AC Drives

Dimensions and Weights

DIMENSIONS AND WEIGHTS

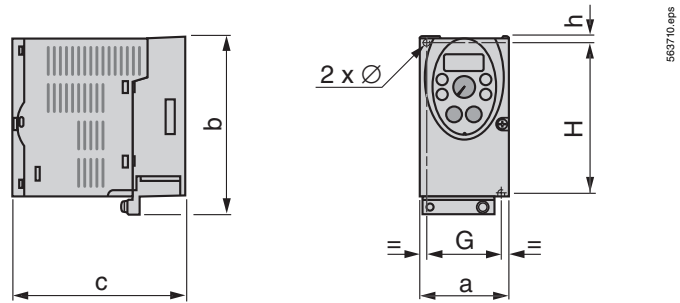

Frame sizes 1–6

ATV31•••••	Frame size	a mm (in.)	b mm (in.)	c mm (in.)	G mm (in.)	h mm (in.)	H mm (in.)	Ø mm (in.)	Weight kg (lb)
H018M3X, H037M3X	1	72 (2.83)	145 (5.71)	120 (4.72)	60 (2.36)	5 (0.20)	121.5 (4.78)	5 (0.20)	0.9 (1.99)
H055M3X, H075M3X	2	72 (2.83)	145 (5.71)	130 (5.12)	60 (2.36)	5 (0.20)	121.5 (4.78)	5 (0.20)	0.9 (1.99)
H018M2, H037M2	3	72 (2.83)	145 (5.71)	130 (5.12)	60 (2.36)	5 (0.20)	121.5 (4.78)	5 (0.20)	1.05 (2.32)
H055M2, H075M2	4	72 (2.83)	145 (5.71)	140 (5.51)	60 (2.36)	5 (0.20)	121.5 (4.78)	5 (0.20)	1.05 (2.32)
HU11M3X, HU15M3X	5	105 (4.13)	143 (5.63)	130 (5.12)	93 (3.66)	5 (0.20)	121.5 (4.78)	5 (0.20)	1.25 (2.76)
HU11M2, HU15M2, HU22M3X, H037N4, H055N4, H075N4, HU11N4, HU15N4, H075S6X, HU15S6X	6	105 (4.13)	143 (5.63)	150 (5.91)	93 (3.66)	5 (0.20)	121.5 (4.78)	2 x 5 (0.20)	1.35 (2.92)

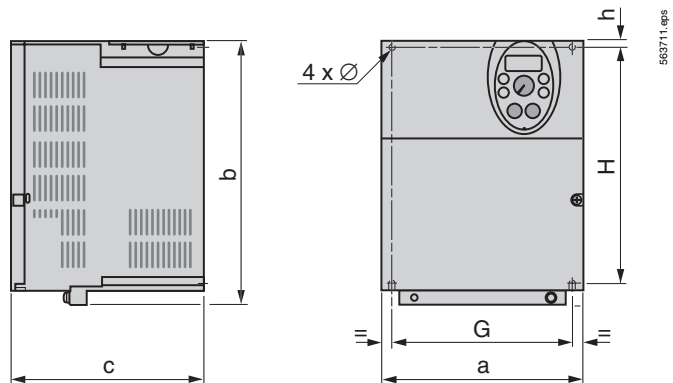

Frame sizes 7–9

ATV31•••••	Frame size	a mm (in.)	b mm (in.)	c mm (in.)	G mm (in.)	h mm (in.)	H mm (in.)	Ø mm (in.)	Weight kg (lb)
HU22M2, HU30M3X, HU40M3X, HU22N4, HU30N4, HU40N4, HU22S6X, HU40S6X	7	140 (5.51)	184 (7.24)	150 (5.91)	126 (4.96)	6.5 (0.26)	157 (6.18)	5 (0.20)	2.35 (5.19)
HU55M3X, HU75M3X, HU55N4, HU75N4, HU55S6X, HU75S6X	8	180 (7.09)	232 (9.13)	170 (6.69)	160 (6.30)	5 (0.20)	210 (8.27)	5 (0.20)	4.70 (10.39)
HD11M3X, HD15M3X, HD11N4, HD15N4, HD11S6X, HD15S6X	9	245 (9.65)	330 (13.0)	190 (7.48)	225 (8.86)	7 (0.28)	295 (11.61)	6 (0.24)	9.0 (19.89)

Altivar® 31 Adjustable Speed AC Drives Dimensions and Weights

DIN rail mounting plates

VW3A11851

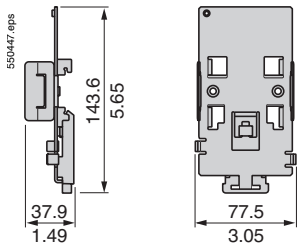

VW3A31852

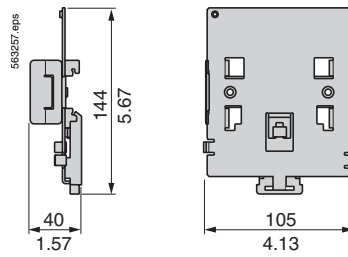

Dimensions: $\frac{\text{mm}}{\text{in.}}$

UL Type 1 conduit entrance kit

VW3A31811 to VW3A31817

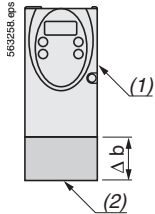

NOTE: The width of the conduit entrance kit is the same as the drive.

1. ATV31 drive
2. Conduit entrance kit VW3A3181*

VW3*****	Δb, mm (in.)
A31811 and A31812	68 (2.68)
A31813 and A31814	68 (2.68)
A31815	68 (2.68)
A31816	96 (3.78)
A31817	98.5 (3.88)

Remote keypad display mounting kit

VW3A31101

Mounting footprint

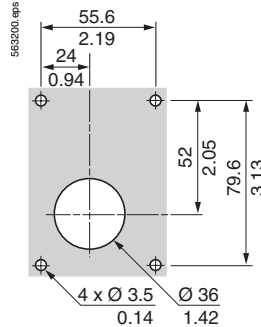

Additional EMC input filters

Mounting the filter beneath the drive

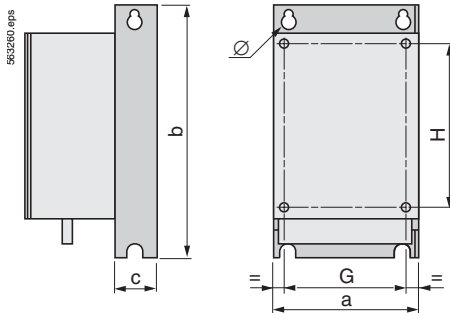

Mounting the filter adjacent to the drive

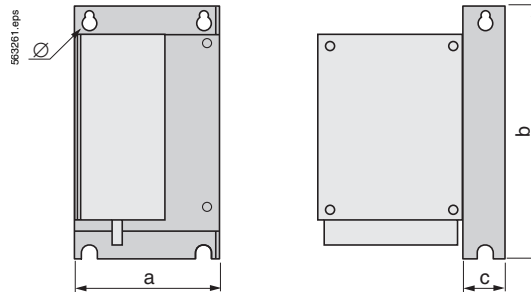

VW3*****	a	b	c	G	H	∅
A31401, A31402	72 (2.82)	195 (7.63)	37 (1.45)	52 (2.04)	180 (7.05)	4.5 (0.18)
A31403	107 (4.2)	195 (7.63)	35 (1.37)	85 (3.32)	180 (7.05)	4.5 (0.18)
A31404	107 (4.2)	195 (7.63)	42 (1.65)	85 (3.32)	180 (7.05)	4.5 (0.18)
A31405	140 (5.48)	235 (9.2)	35 (1.37)	120 (4.7)	215 (8.42)	4.5 (0.18)
A31406	140 (5.48)	235 (9.2)	50 (1.96)	120 (4.7)	215 (8.42)	4.5 (0.18)
A31407	180 (7.05)	305 (11.94)	60 (2.35)	140 (5.48)	285 (11.15)	5.5 (0.22)
A31408	245 (9.59)	395 (15.46)	80 (3.14)	205 (8.03)	375 (14.7)	5.5 (0.22)
A31409	245 (9.59)	395 (15.46)	60 (2.35)	205 (8.03)	375 (14.7)	5.5 (0.22)

Dimensions: mm (in.)

Altivar® 31 Adjustable Speed AC Drives

Dimensions and Weights

Dynamic braking resistor kits

Wall mounting dimensions:
VW3A66711 and VW3A66712

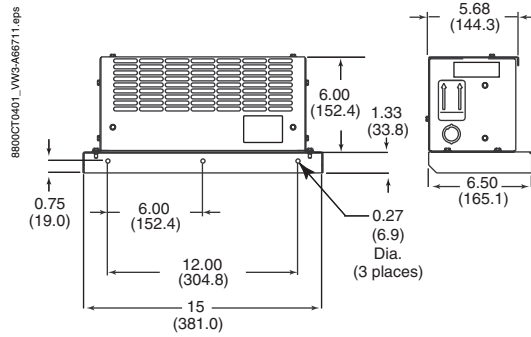

Dimensions: in. (mm)

Wall mounting dimensions:
VW3A66713 and VW3A66714

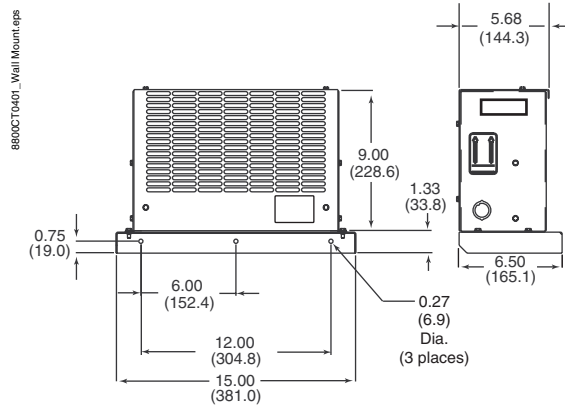

Mounting dimensions:
VW3A66715

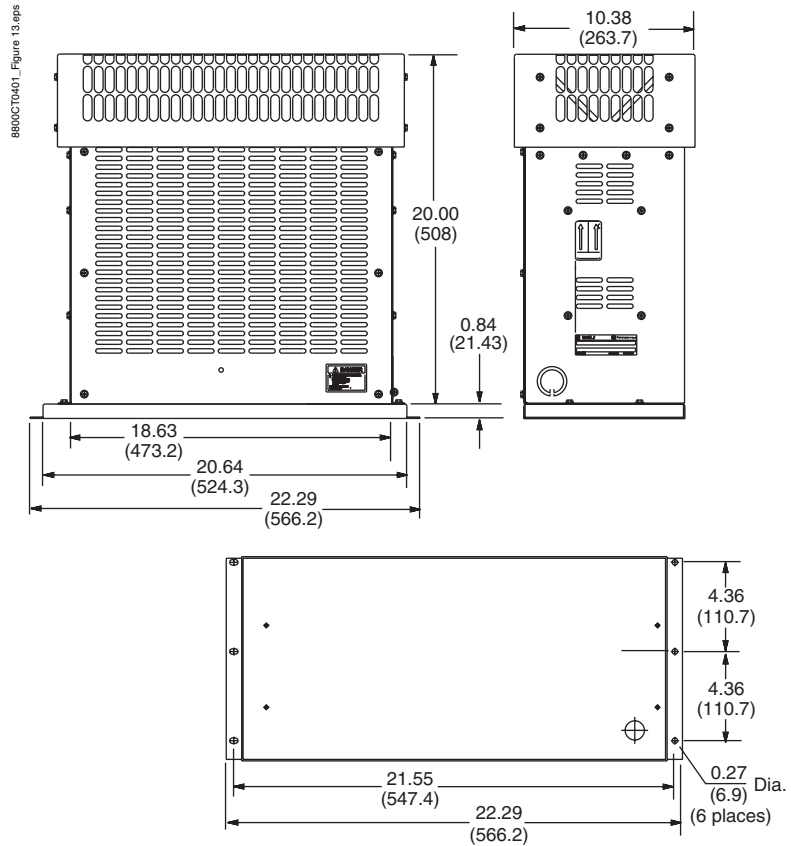

WIRING

Wiring diagram

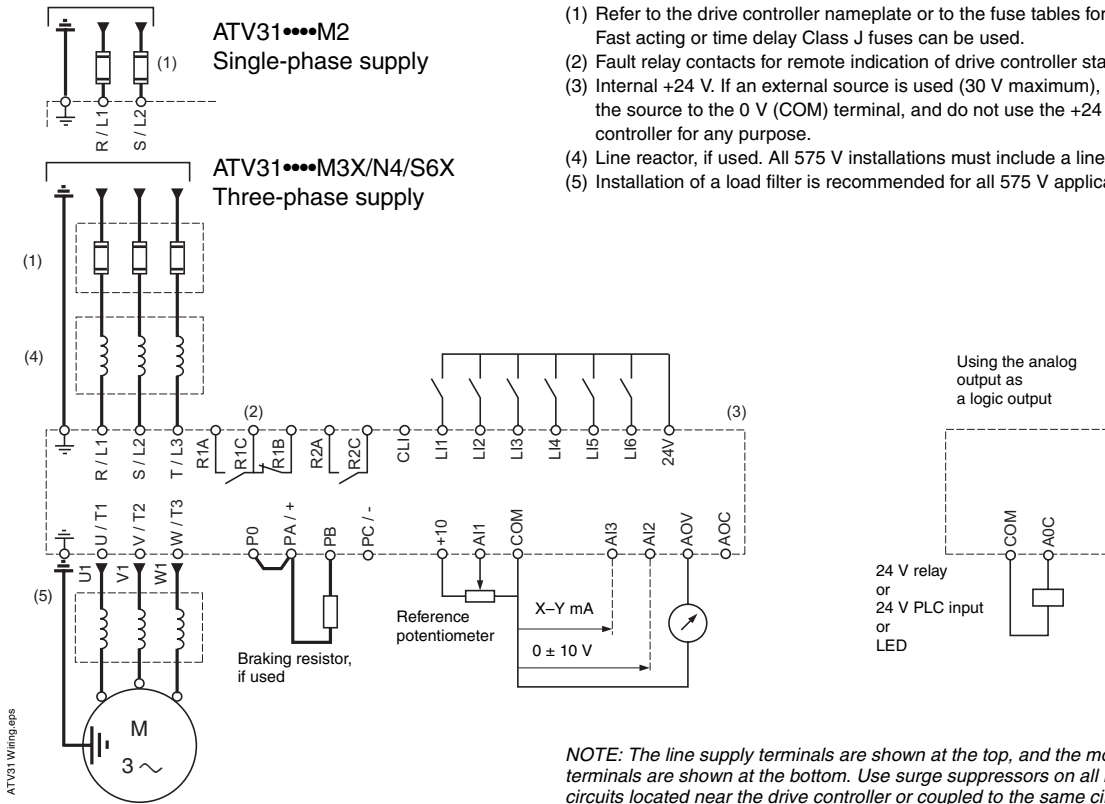

- (1) Refer to the drive controller nameplate or to the fuse tables for recommended fuses. Fast acting or time delay Class J fuses can be used.
- (2) Fault relay contacts for remote indication of drive controller status.
- (3) Internal +24 V. If an external source is used (30 V maximum), connect the 0 V terminal of the source to the 0 V (COM) terminal, and do not use the +24 V terminal on the drive controller for any purpose.
- (4) Line reactor, if used. All 575 V installations must include a line reactor.
- (5) Installation of a load filter is recommended for all 575 V applications.

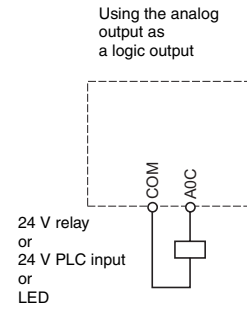

NOTE: The line supply terminals are shown at the top, and the motor terminals are shown at the bottom. Use surge suppressors on all inductive circuits located near the drive controller or coupled to the same circuit. Refer to the Altivar® 31 Installation Manual, VVDED303041US.

Operation on an impedance grounded system

When using the ATV31 drive controller on a system with an isolated or impedance grounded neutral, use a permanent insulation monitor compatible with non-linear loads.

ATV31...M2 and N4 drives feature built-in RFI filters with grounded capacitors. When using the drive on an impedance grounded system, we recommend isolating the RFI filters from ground to prevent reduction of their operating life. For more information, refer to "Operation on an Impedance Grounded System" in the Altivar® 31 Installation Manual, bulletin number VVDED303041US.

Altivar® 31 Adjustable Speed AC Drives Wiring

Recommended fuses or Powerpact® circuit breakers

208/230 V drive controllers

Ø	Motor		Drive ATV31H*****	600 V fuses		Circuit breaker, 22 kA maximum ²	
	kW	hp		Class CC	Class J ¹	208 V	240 V
1 Ø	0.18	0.25	018M2	6 A	6 A	HLL36015	HLL36015
	0.37	0.5	037M2	10 A	10 A	HLL36015	HLL36015
	0.55	0.75	055M2	10 A	10 A	HLL36015	HLL36015
	0.75	1	075M2	15 A	15 A	HLL36020	HLL36015
	1.1	1.5	U11M2	20 A	20 A	HLL36030	HLL36025
	1.5	2	U15M2	20 A	20 A	HLL36035	HLL36030
	2.2	3	U22M2	30 A	30 A	HLL36050	HLL36045
3 Ø	0.18	0.25	018M3X	3 A	3 A	HLL36015	HLL36015
	0.37	0.5	037M3X	6 A	6 A	HLL36015	HLL36015
	0.55	0.75	055M3X	10 A	10 A	HLL36015	HLL36015
	0.75	1	075M3X	10 A	10 A	HLL36015	HLL36015
	1.1	1.5	U11M3X	15 A	15 A	HLL36020	HLL36015
	1.5	2	U15M3X	15 A	15 A	HLL36025	HLL36020
	2.2	3	U22M3X	20 A	20 A	HLL36035	HLL36025
	3	3	U30M3X	25 A	25 A	HLL36045	HLL36040
	4	5	U40M3X	—	35 A	HLL36060	HLL36050
	5.5	7.5	U55M3X	—	50 A	HLL36090	HLL36080
	7.5	10	U75M3X	—	60 A	HLL36110	HLL36100
	11	15	D11M3X	—	80 A	HLL36150	HLL36125
	15	20	D15M3X	—	110 A	JLL36175	JLL36175

460 V drive controllers

Motor		Drive ATV31H*****	600 V fuses		Circuit breaker ² 22 kA maximum
kW	hp		Class CC	Class J ¹	
0.37	0.5	037N4	3 A	3 A	HLL36015
0.55	0.75	055N4	6 A	6 A	HLL36015
0.75	1	075N4	6 A	6 A	HLL36015
1.1	1.5	U11N4	10 A	10 A	HLL36015
1.5	2	U15N4	10 A	10 A	HLL36015
2.2	3	U22N4	15 A	15 A	HLL36015
3	3	U30N4	15 A	15 A	HLL36020
4	5	U40N4	20 A	20 A	HLL36025
5.5	7.5	U55N4	30 A	30 A	HLL36040
7.5	10	U75N4	—	35 A	HLL36050
11	15	D11N4	—	50 A	HLL36070
15	2.0	D15N4	—	70 A	HLL36080

575 V drive controllers

Motor		Drive ATV31H*****	600 V fuses		Circuit breaker ² 22 kA maximum
kW	hp		Class CC	Class J ¹	
0.75	1	075S6X	6 A	6 A	HLL36015
1.5	2	U15S6X	6 A	6 A	HLL36015
2.2	3	U22S6X	10 A	10 A	HLL36015
4	5	U40S6X	15 A	15 A	HLL36020
5.5	7.5	U55S6X	20 A	20 A	HLL36035
7.5	10	U75S6X	25 A	25 A	HLL36045
11	15	D11S6X	—	35 A	HLL36060
15	20	D15S6X	—	45 A	HLL36070

1. Fast acting or time delay.

2. The circuit breaker and the ATV31 drive must be enclosed in a steel enclosure with a minimum volume of 10800 in³.

Logic input switch

The logic input switch assigns the logic input common link to 0 V (Source logic), 24 V (Sink logic), or floating (CLI).

NOTE: When the logic input is configured for Sink logic, grounding the input signals can result in unintended activation of drive controller functions.

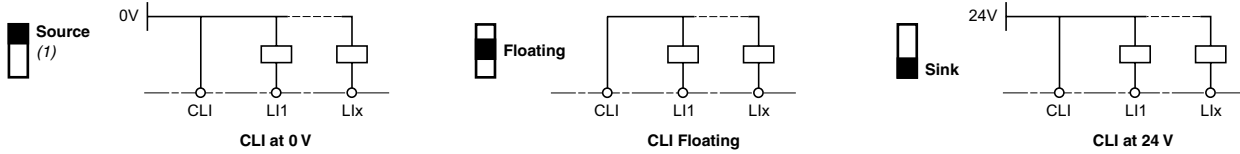

ATV31 Logic Input Switch.eps

Examples of recommended circuit diagrams

Logic input switches (the heavy dashed line represents the drive controller)

Source position (1)
Internal supply

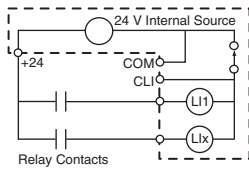

Source or Floating position
External supply or PLC (2)

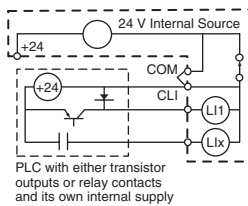

Sink position
Internal supply

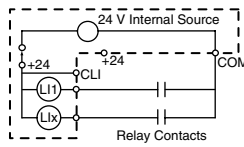

Floating position
External supply or PLC

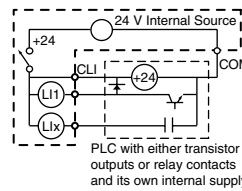

AOC output

Wired as logic output

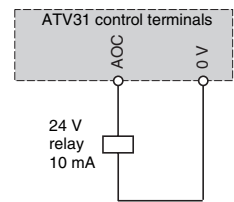

Two-wire control

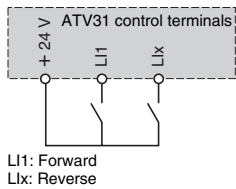

- LI1: Forward
- LIX: Reverse

Three-wire control

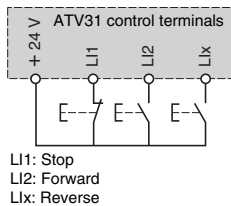

- LI1: Stop
- LI2: Forward
- LIX: Reverse

Analog voltage inputs

± 10 V external

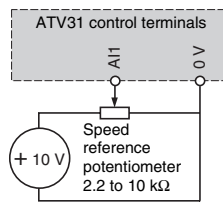

± 10 V external

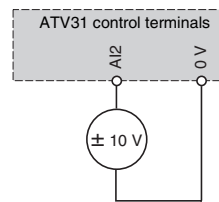

Analog current input

0–20 mA, 4–20 mA, X–Y mA

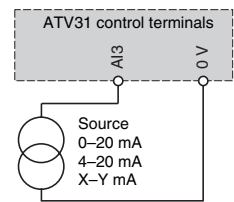

Altivar® 31 Adjustable Speed AC Drives Wiring

Electromagnetic compatibility

Schemes

EMC (RFI) input filters VW3A3140•

Three-phase power supply

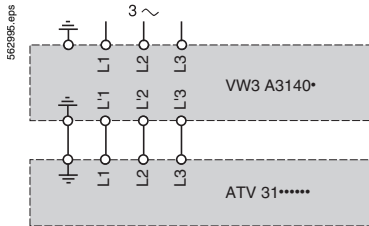

Single-phase power supply

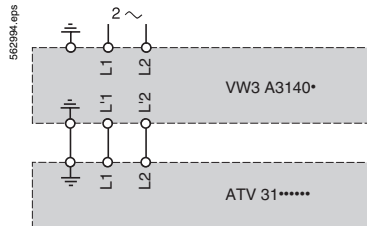

Installation recommendations for meeting EN 55011 Class A

- Ensure that the grounds of the drive controller, the motor, and the cable shields are at equal potential.
- Use shielded cables with the shields connected to ground at both ends of the motor cable, control cables, and the braking resistor (if used). Conduit can be used for part of the shielding length, provided that there is no break in continuity.
- Ensure maximum separation between the power supply cable (line supply) and the motor cable.

For additional information, refer to “Installation Recommendations for Meeting EN 55011 Class A” in the *Altivar® 31 Installation Manual*, bulletin number VVDED303041US.

Frame sizes 1 to 7

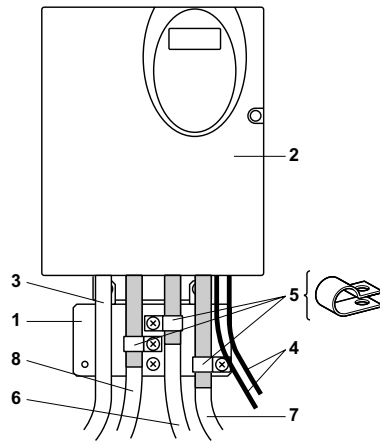

Frame size 8

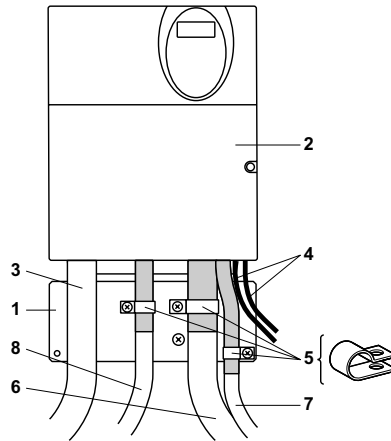

Frame size 9

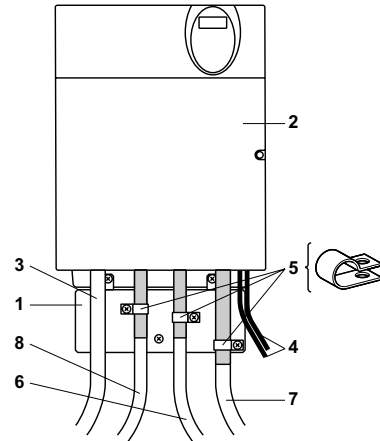

1. EMC plate supplied with the drive controller.
2. ATV31 drive controller.
3. Non-shielded power supply wires or cables.
4. Non-shielded wires for the output of the safety relay contacts.
5. Stainless steel clamps required to securely attach the shields for cables 6, 7, and 8 to the EMC plate.
6. Shielded cable for connection to the motor, with shield connected to ground at both ends. This shield must not be interrupted. If using intermediate terminal blocks, they must be in EMC-shielded metal boxes.
7. Shielded cable for connection to control/command devices. For applications requiring a large number of conductors, small cross-sections must be used (20 AWG/0.5 mm²). This shield must not be interrupted. If using intermediate terminal blocks, they must be in EMC-shielded metal boxes.
8. Shielded cable for connecting the braking resistor, if used. The shield must be unbroken, and connected to ground at both ends. If using intermediate terminals, they must be in EMC-shielded metal boxes.

MOUNTING

Clearances

Install the drive controller vertically, $\pm 10^\circ$.

Do not place the drive controller close to heating sources.

Leave sufficient free space around the drive controller to ensure that air can circulate from the bottom to the top of the unit. Leave a minimum of 10 mm (0.4 in.) of free space in front of the drive controller.

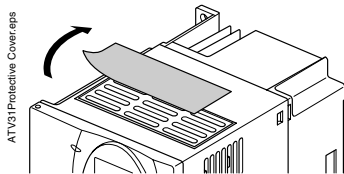
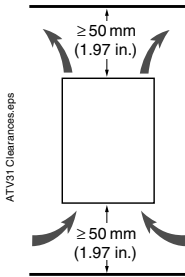

Example:
ATV31HU11M3X

Removing the protective cover

When IP20 protection is adequate, remove the protective cover on top of the drive controller as shown in the figure to the left. Consult "Mounting methods" below to determine the type of mounting appropriate for your application before removing the protective cover from the drive controller. For UL Type 1 protection, the protective cover must remain installed on the top of the controller and a conduit entry kit must be installed.

Mounting methods

Refer to the derating curves on page 30 to determine which mounting method best fits the application.

Type A Mounting

Free space ≥ 50 mm (1.97 in.) on each side, with the protective cover in place.

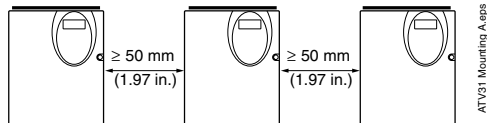

Type B Mounting

Drive controllers mounted side-by-side, with the protective cover removed (degree of protection becomes IP20).

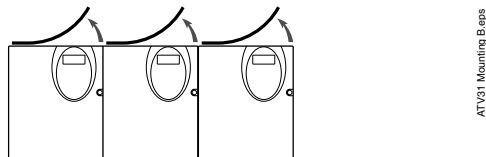

Type C Mounting

Free space ≥ 50 mm (1.97 in.) on each side, with the protective cover removed (degree of protection becomes IP20).

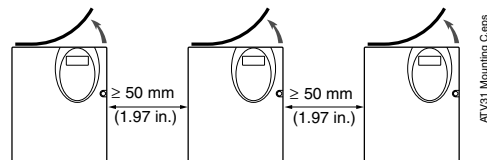

Altivar® 31 Adjustable Speed AC Drives Mounting

Derating curves

The derating curves below show the drive current (I_n) as a function of temperature, switching frequency, and mounting type. For intermediate temperatures, such as 55 °C (131 °F), interpolate between two curves.

ATV31 drive controllers can be used at altitudes up to 3,300 ft (1,000 m) without derating. Derate by 1% for each additional 330 ft (100 m).

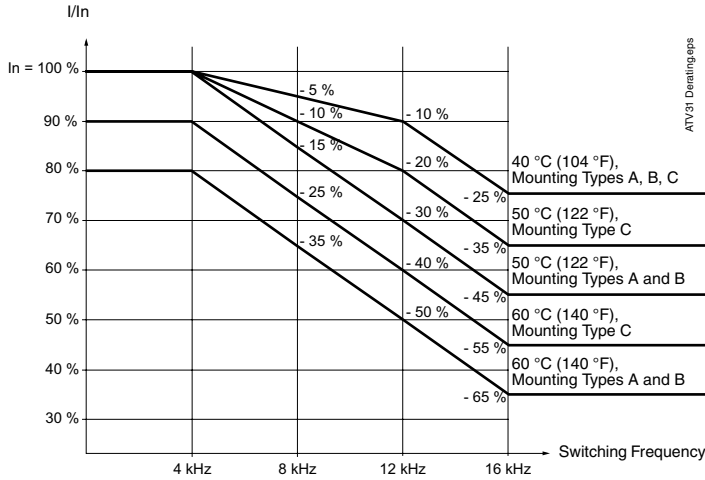

Minimum air flow rates for drives installed in an enclosure

ATV31H*****	Flow rate	
	m ³ /hour	ft ³ /minute (CFM)
018M2, 037M2, 055M2, 018M3X, 037M3X, 055M3X, 037N4, 055N4, 075N4, U11N4, 075S6X, U15S6X	18	10.6
075M2, U11M2, U15M2, 075M3X, U11M3X, U15M3X, U15N4, U22N4, U22S6X, U40S6X	33	19.4
U22M2, U22M3X, U30M3X, U40M3X, U30N4, U40N4, U55S6X, U75S6X	93	54.8
U55M3X, U55N4, U75N4, D11S6X	102	60.1
U75M3X, D11M3X, D11N4, D15N4, D15S6X	168	99.0
D15M3X	216	127.2

Electromagnetic compatibility

An EMC mounting plate is supplied with the drive controller for grounding the shields of the power cables when the installation must meet EN 55011 Class A requirements. Refer to "Electromagnetic Compatibility" in the *Altivar® 31 Installation Manual*, bulletin number VVDED303041US, for instructions on securing the mounting plate and grounding the cable shields on the EMC plate.

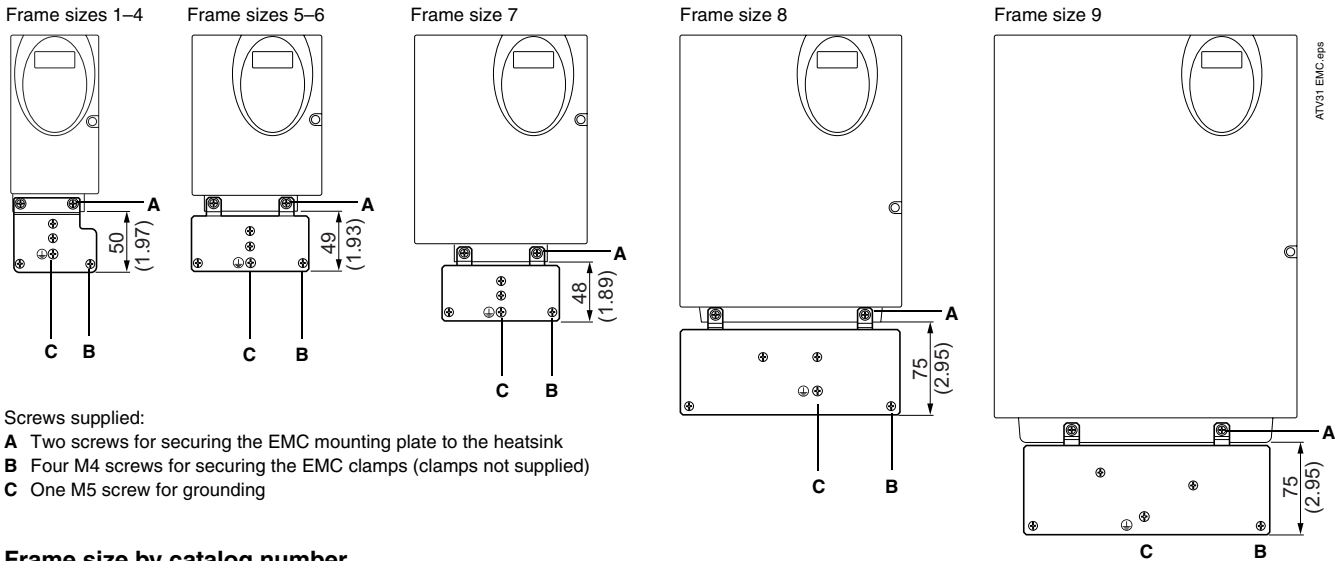

Screws supplied:

- A Two screws for securing the EMC mounting plate to the heatsink
- B Four M4 screws for securing the EMC clamps (clamps not supplied)
- C One M5 screw for grounding

Frame size by catalog number

ATV31H*****	Frame size	ATV31H*****	Frame size	ATV31H*****	Frame size
018M3X, 037M3X	1	U11M2, U15M2, U22M3X, 037N4, 055N4, 075N4, U11N4, U15N4, 075S6X, U15S6X	6	U55M3X, U75M3X, U55N4, U75N4, U55S6X, U75S6X	8
055M3X, 075M3X	2				
018M2, 037M2	3				
055M2, 075M2	4	U22M2, U30M3X, U40M3X, U22N4, U30N4, U40N4, U22S6X, U40S6X	7	D11M3X, D15M3X, D11N4, D15N4, D11S6X, D15S6X	9
U11M3X, U15M3X	5				

Mounting in a Type 12 or IP54 metal enclosure

Calculating enclosure size

For the power dissipated by the drive controllers at rated load, see the tables on pages 10–11.

The equation for calculating R_{th} (°C/W), the maximum allowable thermal resistance of the enclosure, is as follows:

$$R_{th} = \frac{T_i - T_o}{P}$$

T_i = Max. internal ambient temp. (°C) around the controller
 T_o = Max. external ambient temp. (°C) around the enclosure
 P = Total power dissipated in the enclosure (W)

The useful heat exchange surface area, S (in²), of a wall-mounted enclosure generally consists of the sides, top, and front. Calculate the minimum surface area required for a drive controller enclosure as follows:

Contact the enclosure manufacturer for K factors.

$$S = \frac{K}{R_{th}}$$

K = Thermal resistance per square inch of the enclosure
 R_{th} = Thermal resistance of the enclosure (calculated previously)

Consider the following points when sizing the enclosure:

- Use only metal enclosures, since they have good thermal conduction.
- Do not install enclosures where external heat sources (such as direct sunlight) can add to the enclosure heat load. This procedure does not consider radiant or convected heat load from external sources.
- If additional devices are present inside the enclosure, consider the heat load of those devices in the calculation.
- The actual useful area for convection cooling of the enclosure varies depending on the mounting method. The mounting method must allow for free air movement over all surfaces considered for convection cooling.

Example

The following example calculates the enclosure size for an ATV31HU40N4 (5 hp) drive mounted in a Type 12 or IP54 enclosure.

- Maximum external temperature: $T_o = 25\text{ °C}$
- Power dissipated inside the enclosure: $P = 150\text{ W}$
- Maximum internal temperature: $T_i = 40\text{ °C}$
- Thermal resistance per square inch of the enclosure: $K = 186$

Maximum allowable thermal resistance, R_{th}

$$R_{th} = \frac{40\text{ °C} - 25\text{ °C}}{150\text{ W}} = 0.115\text{ °C/W}$$

Minimum useful heat exchange surface area, S

$$S = \frac{186}{0.115} = 1624.4\text{ in.}^2$$

Useful heat exchange surface area (S) of the proposed wall-mounted enclosure

Height: 28 in. (711 mm) front area top area side area
Width: 24 in. (610 mm) ↓ ↓ ↓
Depth: 12 in. (305 mm) S = (24 × 28) + (24 × 12) + 2(28 × 12) = 1632 in.²

If the selected enclosure does not provide the required surface area or does not meet application needs, consider the following options:

- Use a larger enclosure.
- Add a passive heat exchanger to the enclosure.
- Add an air conditioning unit to the enclosure.

Ventilation

NOTE: Where condensation is possible, keep the drive controller powered up when the motor is not running, or install thermostatically controlled strip heaters.

When mounting the drive controller inside a Type 12 or IP54 enclosure, follow these ventilation precautions:

- Observe the minimum clearance distances shown on page 29.
- If necessary, install a stirring fan to circulate the air inside the enclosure, to prevent hot spots in the drive controller and to distribute the heat uniformly to surfaces used for convection cooling.

Altivar® 31 Adjustable Speed AC Drives Functions

FUNCTIONS

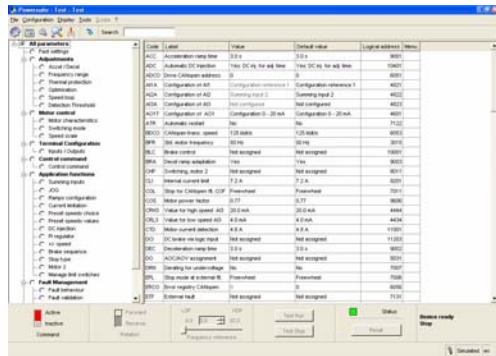

PowerSuite software screen—Parameters List



PowerSuite software screen—Monitoring screen

Summary of functions

Page number

Drive factory settings	33
Functions of the drive local keypad display	33
Remote keypad display option	34
Menu access levels	34
Access locking code	34
Operating speed range	34
Acceleration and deceleration ramp times	34
Acceleration and deceleration ramp profile	35
Ramp switching	35
Automatic adaptation of the deceleration ramp	36
Voltage/frequency ratio	36
Auto-tuning	36
Switching frequency, noise reduction	37
Skip frequencies	37
Speed reference	37
Analog inputs	37
Preset speeds	38
+/- Speed	38
Save reference	39
Jog operation	39
Control and reference channels	40
Reference switching	40
Summing inputs	40
PI regulator	41
Spooling	41
Current limit switching	42
Limiting low speed operating time	42
Motor switching	42
Control channel switching	43
Two-wire control	43
Three-wire control	43
Forced local mode	43
Freewheel stop	43
Fast stop	44
DC injection stop	44
Brake control	44
Limit switch management	45
Monitoring	45
Fault management	46
Fault reset	46
General reset (reset all faults)	46
Controlled stop on loss of line supply	46
Stop mode in the event of a fault	47
Automatic catch a spinning load with speed detection (catch on the fly)	47
Automatic restart	47
Derated operation in the event of an overvoltage	48
Resetting the fault relay	48
Operating time reset to zero	48
Motor thermal protection	48
Drive thermal protection	49
R1/R2 relay configuration	49
AOC/AOV analog output	49
Saving and retrieving the configuration	49
Function compatibility table	50

Altivar® 31 Adjustable Speed AC Drives Functions

Drive factory settings

The drive comes from the factory ready for use in most applications, with the following functions and settings:

- Nominal motor frequency: 50 Hz
- Motor voltage:
 - 230 V (ATV31H•••M2 and M3X)
 - 400 V (ATV31H•••N4)
 - 600 V (ATV31H•••S6X)
- Linear ramp times: 3 seconds
- Low speed (LSP): 0 Hz
- High speed (HSP): 50 Hz
- Normal stop mode on deceleration ramp
- Stop mode in the event of a fault: Freewheel
- Motor thermal current = nominal drive current
- DC injection braking current = 0.7 x nominal drive current, for 0.5 seconds
- Constant torque operation with sensorless flux vector control
- Logic inputs:
 - Two rotation directions (LI1, LI2), two-wire control
 - Four preset speeds (LI3, LI4): LSP (low speed), 10 Hz, 15 Hz, 20 Hz
- Analog inputs:
 - AI1 speed reference (0 to 10 V)
 - AI2 (0 ± 10 V) summing of AI1
 - AI3 (4–20 mA) not assigned
- Relay R1: fault relay
- Relay R2: not assigned
- Analog output AOC: 0–20 mA, representation of the motor frequency
- Automatic adaptation of the deceleration ramp in the event of excessive braking
- Switching frequency 4 kHz, random frequency

Functions of the drive local keypad display

1. Four 7-segment displays showing information in the form of codes or values
2. Up/down buttons for scrolling through the menus or modifying values
3. ENT button for entering a menu or saving the new value selected
4. ESC button for exiting the menus without saving
5. Two diagnostic LEDs for the CANopen bus

For ATV31H•••M2A, ATV31H•••M3XA and ATV31H•••N4A drives only:

6. Speed reference potentiometer
7. RUN: Local control of motor operation
8. STOP/RESET: Local control of motor stopping and fault reset

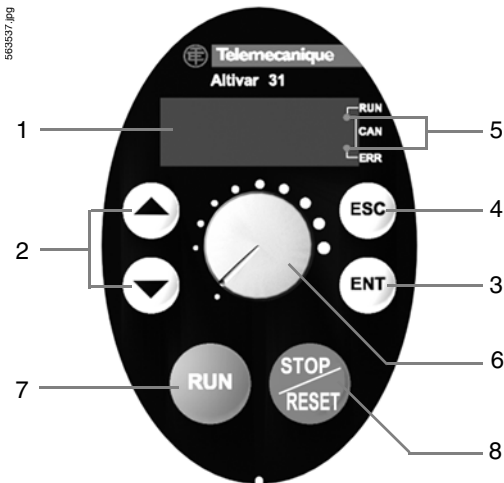

Altivar® 31 Adjustable Speed AC Drives Functions



Remote keypad display

Remote keypad display option

The remote keypad display—for mounting on the door of a wall-mounted or floor-standing enclosure—contains (a) an LCD display with programming and control keys, and (b) a switch for locking access to the menus.

NOTE: Protection using the access locking code has priority over the switch.

The drive control keys function as follows:

- FWD/REV: reverses the rotation direction
- RUN: commands the motor to run
- STOP/RESET: commands the motor to stop; resets a fault
- Up and down arrow keys: adjust the speed reference

When the drive is configured to use the remote keypad display, only the freewheel stop, fast stop, and DC injection stop commands remain active on the terminal block. If the link is broken between the drive and the remote keypad display, the drive faults. Its subsequent action depends on the control and reference channel programming.

Menu access levels

There are three access levels:

- Level 1:** Access to standard functions.
(This level is comparable to the ATV28 drive.)
- Level 2:** Access to Level 1 functions, plus advanced application functions.
- Level 3:** Access to Level 2 functions, plus management of mixed control and reference modes.

Access locking code

This function protects the drive configuration using an access code. When access is protected, only the adjustment and monitoring parameters are accessible.

Operating speed range

This function sets the two frequency limits—high speed and low speed—that define the speed range permitted by the machine under actual operating conditions for all applications, with or without overspeed.

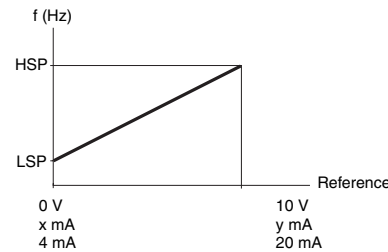

Operating speed range

LSP: low speed, from 0 to HSP, factory setting 0
HSP: high speed, from LSP to f max., factory setting 50 Hz
x: configurable between 0 and 20 mA, factory setting 4 mA
y: configurable between 4 and 20 mA, factory setting 20 mA

Acceleration and deceleration ramp times

This function defines the acceleration and deceleration ramp times according to the application and the machine dynamics.

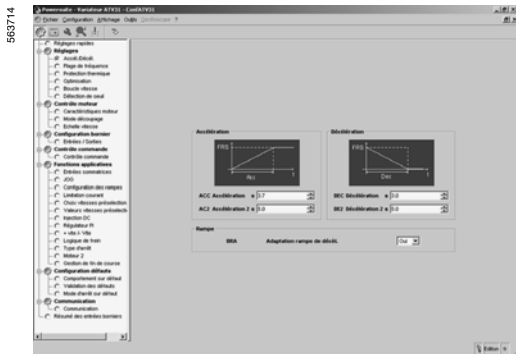

Ramp adjustment with PowerSuite software

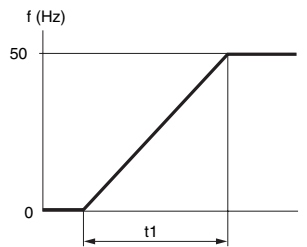

Linear acceleration ramp
t1: acceleration time

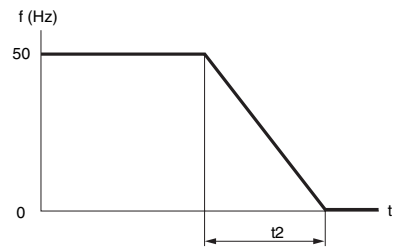

Linear deceleration ramp
t1 and t2 can be set independently between 0.1 and 999.9 s. Factory setting: 3 s.

Acceleration and deceleration ramp profile

This function gradually increases the output frequency, starting from a speed reference and following either a linear ratio or a preset ratio.

- For applications such as material handling, packaging, and transporting people: Using **S ramps** takes up mechanical play, eliminates jolts, and limits non-following of speed during rapid transient operation of high inertia machines.
- For pumping applications (installation with centrifugal pump and non-return valve): Using **U ramps** controls valve closing more accurately.

Selecting linear, S, U, or customized profiles affects both the acceleration and deceleration ramps.

S ramps

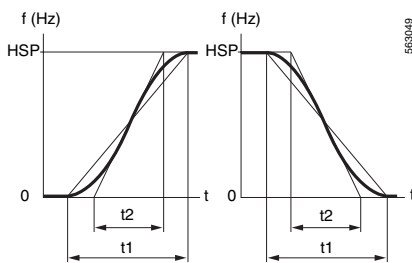

HSP: high speed
t1: ramp time set
t2: $0.6 \times t1$
 The curve coefficient is fixed.

U ramps

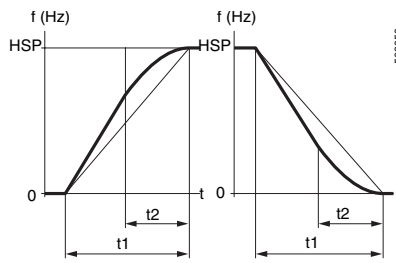

HSP: high speed
t1: ramp time set
t2: $0.5 \times t1$
 The curve coefficient is fixed.

Customized ramps

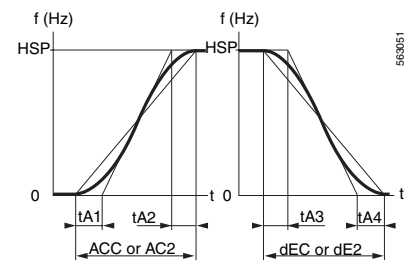

HSP: high speed
ACC: acceleration ramp 1 time
AC2: acceleration ramp 2 time
dEC: deceleration ramp 1 time
dE2: deceleration ramp 2 time
tA1: adjustable between 0 and 100% (of ACC or AC2)
tA2: adjustable between 0 and $(100\% - tA1)$ (of ACC or AC2)
tA3: adjustable between 0 and 100% (of dEC or dE2)
tA4: adjustable between 0 and $(100\% - tA3)$ (of dEC or dE2)

Ramp switching

This function switches two acceleration or deceleration ramp times, which are separately adjustable. It is enabled by a logic input, a frequency threshold, or a combination of the two.

Ramp switching is suited to material handling with smooth starting and approach, and to machines with fast steady-state speed correction.

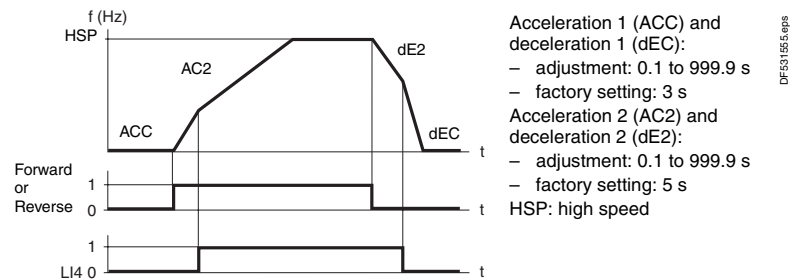

Example of switching using logic input LI4

Acceleration 1 (ACC) and deceleration 1 (dEC):
 – adjustment: 0.1 to 999.9 s
 – factory setting: 3 s
 Acceleration 2 (AC2) and deceleration 2 (dE2):
 – adjustment: 0.1 to 999.9 s
 – factory setting: 5 s
HSP: high speed

Altivar® 31 Adjustable Speed AC Drives Functions

Automatic adaptation of the deceleration ramp

If the initial deceleration ramp setting is too low for the load inertia, this function automatically modifies the ramp, preventing the drive from faulting due to excessive braking.

This function is suited to all applications not requiring precise stopping and not using braking resistors.

Automatic adaptation must be cancelled if the machine has position control with stopping on a ramp and a braking resistor installed. This function is automatically disabled if the brake sequence is configured.

Voltage/frequency ratio

Motor and power supply characteristics

These characteristics determine the limit values for the voltage/frequency ratio according to the line supply, the motor, and the application.

The following values should be set for variable or constant torque applications, with or without overspeed:

- the base frequency, which corresponds to the supply
- the nominal motor frequency (in Hz) given on the motor nameplate
- the nominal motor voltage (in V) given on the motor nameplate
- the maximum output frequency of the drive (in Hz)

Type of voltage/frequency ratio

This designation adapts the voltage/frequency ratio to the application, to optimize performance for the following:

- **Ratio L**—Constant torque applications (machines with average loads operating at low speed) with motors connected in parallel or with special motors (e.g., resistive cage motor)
- **Ratio P**—Variable torque applications (pumps, fans)
- **Ratio n**—Machines with heavy loads operating at low speed, with fast cycles, or with sensorless flux vector control
- **Ratio nLd**—Energy saving, for machines with slow speed and torque variations. Voltage is automatically reduced to a minimum according to the necessary torque.

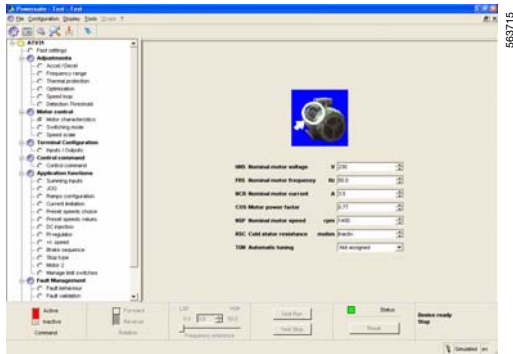

Adjusting the voltage/frequency ratio in PowerSuite software

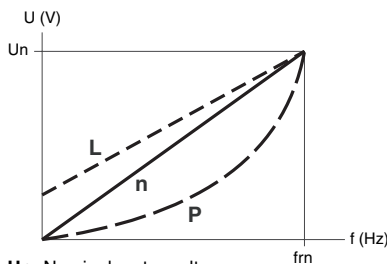

Un: Nominal motor voltage
frn: Nominal motor frequency

Auto-tuning

Auto-tuning optimizes application performance. It can be executed:

- when the operator sends a command via the local or remote keypad display or the serial link
- each time the drive is powered up
- each time a run command is sent
- when the logic input assigned to this function transitions from 0 to 1

Switching frequency, noise reduction

The setting of the switching frequency permits a reduction in the noise generated by the motor.

The switching frequency is modulated randomly to avoid resonance. This function can be disabled if it causes instability.

Switching the intermediate DC voltage at high frequency is useful for supplying the motor with a current wave having little harmonic distortion. The switching frequency is adjustable during operation to reduce the noise generated by the motor.

The value ranges from 2 to 16 kHz, with a factory setting of 4 kHz.

This function is suited to all applications requiring low motor noise.

Skip frequencies

This function suppresses one or two critical speeds that may cause mechanical resonance. It prohibits the prolonged operation of the motor on one or two frequency bands (with a bandwidth of ± 1 Hz), adjustable within the operating range.

This function is suited to lightweight machines, bulk product conveyors with an unbalanced motor, fans, and centrifugal pumps.

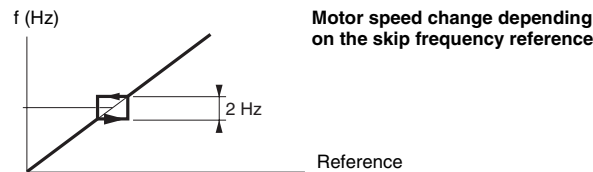

Speed reference

The speed reference can come from the following sources, depending on the drive configuration:

- the three analog inputs
- the potentiometer (for ATV31•••••A drives only)
- the logic inputs, using the +/- Speed function
- the drive local keypad display or remote keypad display
- the communication networks

These different sources are managed by programming the reference functions and channels.

Analog inputs

There are three analog inputs:

- Two voltage inputs
 - 0 to 10 V (AI1)
 - ± 10 V (AI2)
- One current input
 - X-Y mA (AI3) where X is configurable between 0 and 20 mA, and Y is configurable between 4 and 20 mA.

Altivar® 31 Adjustable Speed AC Drives Functions

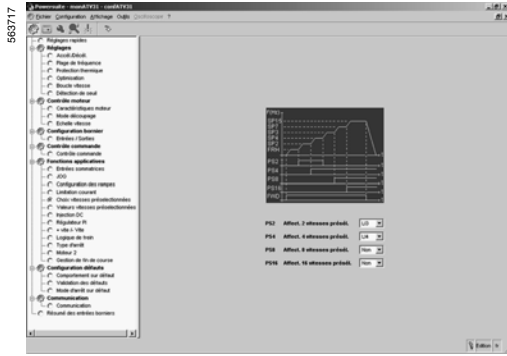

Adjusting the preset speeds in PowerSuite software

Preset speeds

This function permits the switching of preset speed references. Choose between two, four, eight, or sixteen preset speeds, enabled via one, two, three, or four logic inputs respectively. Preset speeds are adjustable in increments of 0.1 Hz, from 0 Hz to 500 Hz.

Preset speeds are suited to material handling and to machines with several operating speeds.

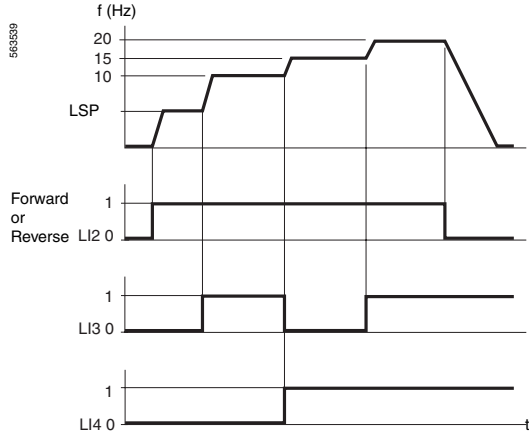

The speed obtained with inputs LI3 and LI4 at state 0 is LSP or the speed reference, depending on the level of analog inputs AI1, AI2, and AI3.

Factory settings:

- 1st speed: LSP (low speed or speed reference)
- 2nd speed: 10 Hz
- 3rd speed: 15 Hz
- 4th speed: 20 Hz (high speed)

Example of operation with four preset speeds and two logic inputs

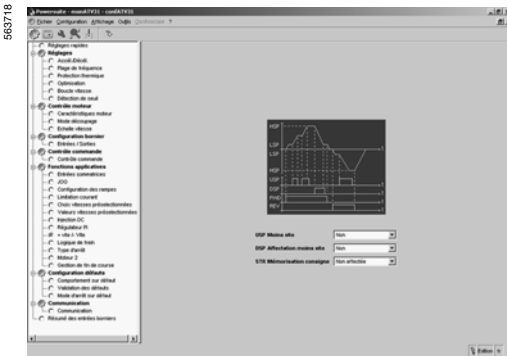

Adjusting the +/- Speed function in PowerSuite software

+/- Speed

This function increases or decreases a speed reference using single action buttons or double action buttons (such as on a pendant station).

Single action buttons

Single action buttons require two logic inputs and two directions of rotation. The input assigned to the +speed command increases the speed; the input assigned to the -speed command decreases the speed. The maximum speed is set by HSP.

Direction	-Speed	Speed maintained	+Speed
Forward	a and d	a	a and b
Reverse	c and d	c	c and b

Motor frequency

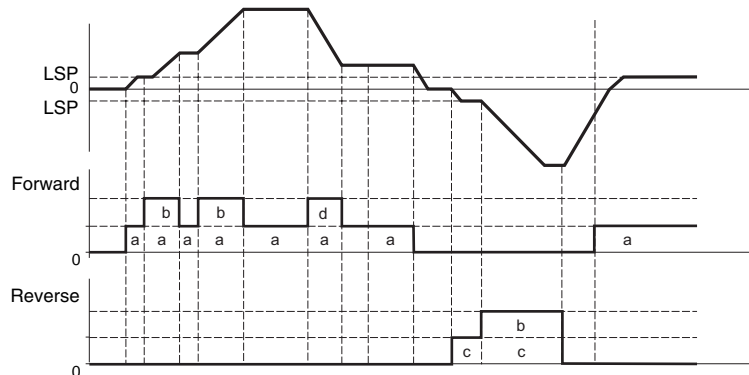

8800CT0401_PlusSpeed_MinusSpeed_2.eps

Example of wiring:

- LI1: forward
- LIx: reverse
- LIy: +speed (USP)
- LIz: -speed (DSP)

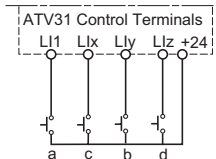

8800CT0401_Single Action Button

Altivar® 31 Adjustable Speed AC Drives Functions

Double action buttons

Only one logic input, assigned to +speed, is required for double action buttons. Double action buttons typically have two detents. Press the button to the first detent to maintain speed; press it to the second detent to increase speed. Each action closes a contact. Refer to the following table.

Example of wiring:

Ll1: forward
Llx: reverse
Lly: +speed (USP)

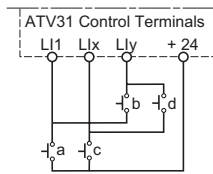

8800CT0401_Double Action Button

Button	Released (-speed)	Press to 1 st detent (speed maintained)	Press to 2 nd detent (+speed)
Forward	—	a	a and b
Reverse	—	c	c and d

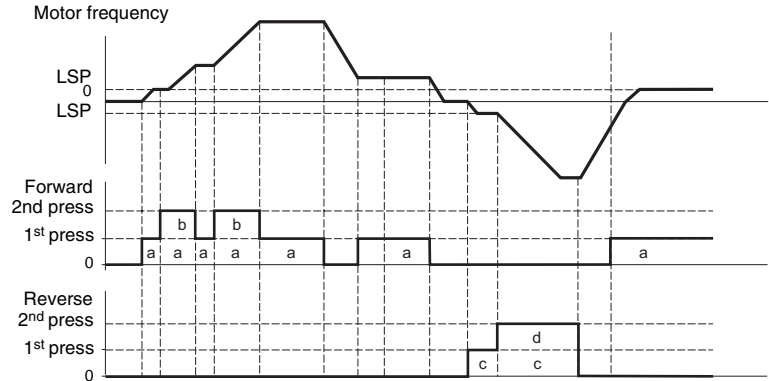

8800CT0401_Plus Speed_Minus Speed.eps

This type of +/- Speed is incompatible with three-wire control.

The maximum speed is set by HSP.

Save reference

This function, associated with +/- Speed control, enables the drive to save and read the last speed reference. If the run signal or mains supply is lost, the drive applies the saved reference at the next run signal.

Jog operation

The jog function permits pulse operation with minimum ramp times (0.1 s), limited speed reference, and minimum time between two pulses. It is enabled using a logic input, with pulses given by the rotation direction command.

This function is suited to machines with product insertion in manual mode (for example, gradual movement of the mechanism during maintenance operations).

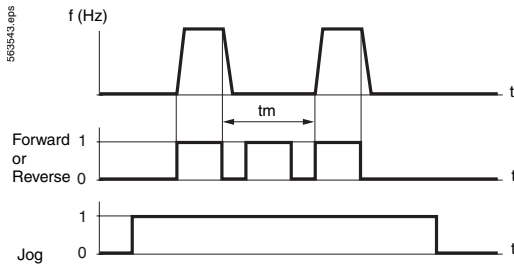

Speed reference:
adjustable from 0 to 10 Hz
factory setting = 10 Hz

tm: fixed time of 0.5 s,
minimum time between
two pulses

Example of jog operation

Altivar® 31 Adjustable Speed AC Drives Functions

Control and reference channels

The drive receives control commands—such as forward and reverse—and speed reference commands from the following sources:

- the logic and analog inputs
- the drive local keypad display (on ATV31•••••A drives only)
- the remote keypad display
- the serial link
 - Modbus control word
 - CANopen control word

You can assign control and reference sources to separate control channels and switch between them—for example, by giving the speed reference via the CANopen serial link but the control commands via the remote keypad display.

NOTE: The STOP keys on the local keypad display and the remote keypad display may retain priority. The Summing inputs and PI regulator functions only apply to one reference channel.

Reference switching

Switching between two speed references is enabled using a logic input or a bit in a Modbus or CANopen control word.

Reference 1 is active if the logic input (or control word bit) is at 0; reference 2 is active if the logic input (or control word bit) is at 1.

The reference can be switched with the motor running.

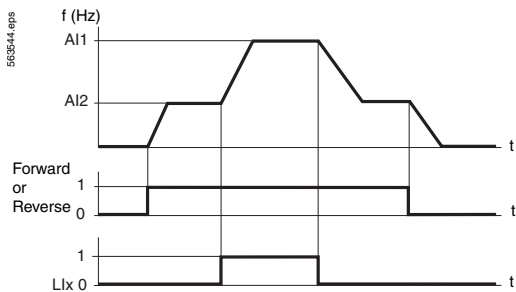

Example of reference switching

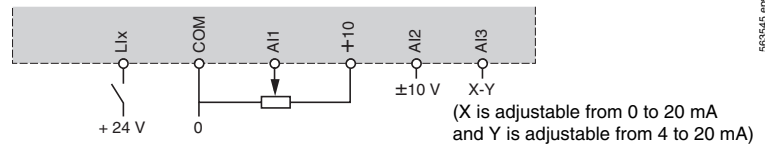

Connection diagram for reference switching

Summing inputs

This function sums two or three speed references from different sources. The references can come from any of the various speed reference sources.

Example:

Reference 1 sent by AI1

Reference 2 sent by the potentiometer

Reference 3 sent by the CANopen serial link

Drive speed reference = reference 1 + reference 2 + reference 3

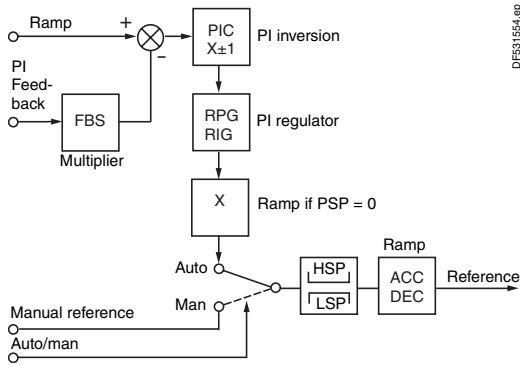

DFE31554-09

- ACC:** Acceleration
- DEC:** Deceleration
- FBS:** PI feedback multiplication coefficient
- HSP:** High speed
- PIC:** Reversal of the direction of correction of the PI regulator
- LSP:** Low speed
- RIG:** PI regulator integral gain
- RPG:** PI regulator proportional gain

PI regulator function

PI regulator

This function, suited to pumping and ventilation applications, provides simple process control using a sensor that sends the drive a feedback signal (such as flow rate or pressure) for regulating proportional and integral gain.

PI reference

- Internal regulator reference, adjustable from 0 to 100
- Manual reference, selected from any of the possible reference sources
- Two or four preset PI references, adjustable from 0 to 100, requiring the use of one or two logic inputs respectively

NOTE: The PI reference can also be transmitted via the Modbus RS-485 serial link or the CANopen bus.

PI feedback

PI feedback is assigned using analog input AI1, AI2, or AI3.

Auto/manual

Logic input LI switches the operation to speed reference (Manual) or PI regulation (Auto).

During operation in automatic mode, the process feedback can be adapted to correct inverse PI, adjust the proportional and integral gain, or apply a ramp ($time = ACC - DEC$) for establishing the PI action on starting and stopping.

Motor speed is limited to the range from LSP to HSP.

NOTE: The PI function is incompatible with the Preset Speeds and Jog Operation functions.

Spooling

This function, for winding reels of thread in textile applications, is available with ATV31•••T drives only.¹

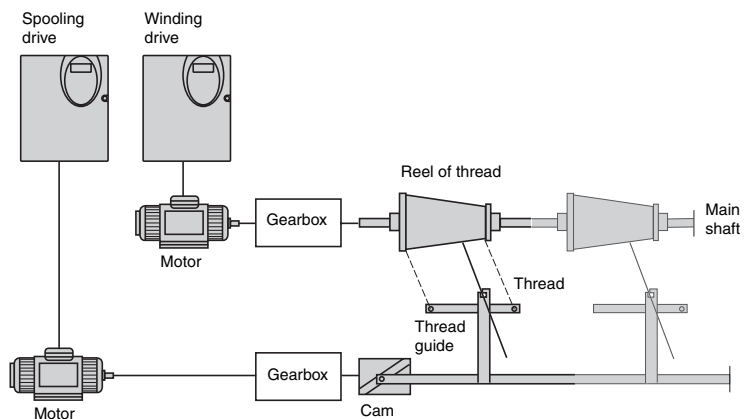

650064-09ps

The cam's rotation speed must follow a precise profile to ensure steady winding.

continued

1) These drives are available by special order only.

Altivar® 31 Adjustable Speed AC Drives Functions

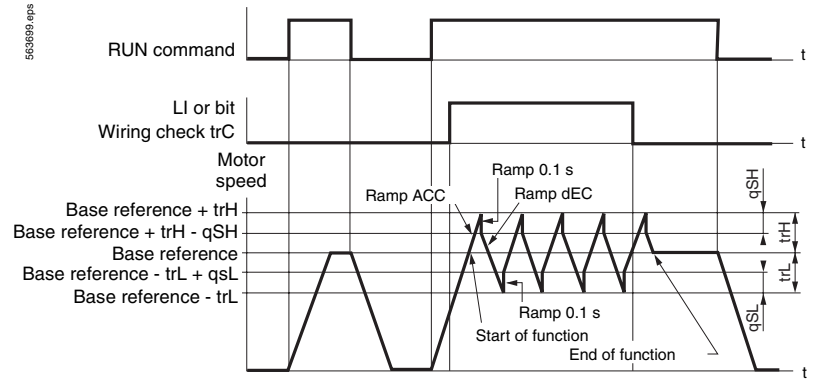

When the spooling function is configured, the ramp type is forced to linear ramp.

Current limit switching

To limit the torque and the temperature rise of the motor, a second current limit can be configured between 0.25 and 1.5 times the nominal drive current.

Switching between two current limits is enabled using a logic input or a bit in a Modbus or CANopen control word.

Limiting low speed operating time

This function, suited for automatically stopping or starting pressure-regulated pumps, stops the motor after operating for a specified period at low speed (LSP) with zero reference and a run command present. The motor restarts automatically on the ramp when the reference reappears or when the run command is broken, then re-established.

The time is adjustable between 0.1 and 999.9 seconds. The factory setting is 0, corresponding to an unlimited time.

Motor switching

Motor switching allows two motors with different ratings or characteristics to be supplied alternately by the same drive. Switching must occur with the drive stopped and locked, using an appropriate sequence at the drive output.

Motor switching is enabled by a logic input or a bit in a Modbus or CANopen control word. In hoisting applications, motor switching enables the use of a single drive for vertical and horizontal movements. The function adapts the motor parameters, switching the following parameters automatically:

- nominal motor voltage
- nominal motor frequency
- nominal motor current
- nominal motor speed
- motor cosine Phi (power factor)
- selection of the type of voltage/frequency ratio for motor 2
- IR compensation, motor 2
- motor frequency loop gain
- motor stability
- motor slip compensation

NOTE: This function disables motor thermal protection.

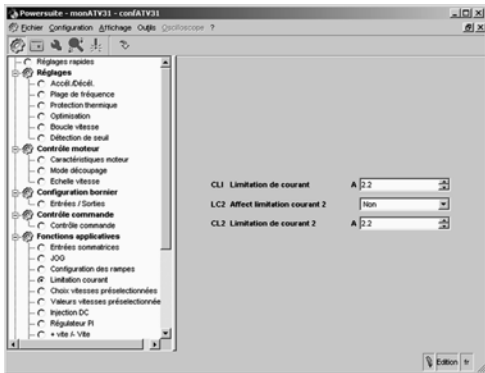

Configuration of current switching with PowerSuite software

Control channel switching

Control channel switching provides a choice of two control channels. Switching is enabled using a logic input or a bit in a Modbus or CANopen control word.

Two-wire control

This function uses a maintained contact to control the rotation direction. It is enabled using one or two logic inputs (one or two directions).

Two-wire control is suited to all non-reversing and reversing applications. Three operating modes are possible:

- detection of the logic input state
- detection of a change in the logic input state
- detection of the logic input state, with forward rotation always having priority over reverse

Wiring diagram for two-wire control

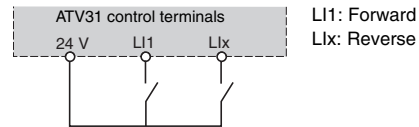

563547.eps

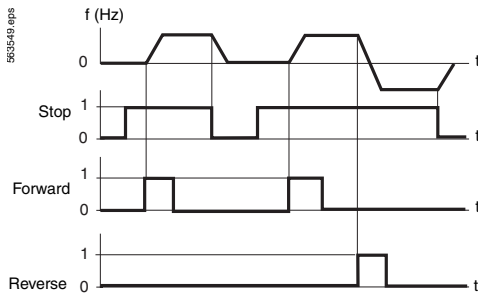

Example of operation with three-wire control

Three-wire control

This function controls the rotation direction and the stop operation using pulsed contacts. It is enabled using two or three logic inputs (one or two directions). Three-wire control is suited to all non-reversing and reversing applications.

Wiring diagram for three-wire control

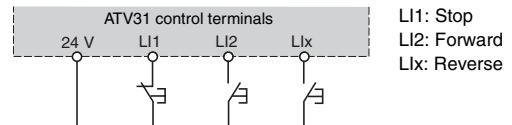

563548.eps

Forced local mode

Forced local mode imposes control through the terminals or through the local or remote keypad display. It prohibits all other control modes.

This mode allows selection of the following reference and command channels:

- reference via AI1, AI2, or AI3 with control via the logic inputs
- reference and control via the RUN and STOP keys and potentiometer on the local keypad display (ATV31•••••A drives only)
- reference and control via the remote keypad display

A logic input enables the changeover to forced local mode.

Freewheel stop

This function stops the motor by resistive torque if the motor power supply is cut. A freewheel stop is achieved by enabling a logic input or by configuring a normal stop command as a freewheel stop (on the removal of a run command or the initiation of a stop command).

Altivar® 31 Adjustable Speed AC Drives Functions

Fast stop

This function allows a braked stop with a deceleration ramp time (divided by 2 to 10) acceptable for the drive to avoid an excessive braking fault.

Fast stop is used for conveyors with emergency stop electrical braking. It is achieved by enabling a logic input or by configuring a normal stop as a fast stop (on the removal of a run command or the initiation of a stop command).

DC injection stop

This function is for low-speed braking of high inertia fans or for maintaining torque when stopping fans located in an airflow.

A DC injection stop is achieved by enabling a logic input or by configuring a normal stop as a DC injection stop (on the removal of a run command or the initiation of a stop command).

The DC value and the injection braking time are adjustable.

Brake control

With this function active, the drive manages the brake control sequence to synchronize the control of an electromagnetic brake with the starting and stopping of the motor, to avoid jolts and load veering.

- Adjustable values for **releasing** the brake: current threshold and time delay
- Adjustable values for **engaging** the brake: frequency threshold and time delay

This function is enabled by assigning brake control to relay logic output R2 or logic output AOC.

Brake control is suited to material handling applications with movements equipped with electromagnetic brakes (hoisting) and machines requiring a parking brake (unbalanced machines).

Principle

- **Vertical lifting movement**
Maintain the motor torque in an upward direction when the brake is released and engaged, to hold the load and start smoothly as soon as the brake is released.
- **Horizontal lifting movement**
Synchronize the brake release with the build-up of torque on starting, and the brake engagement with zero speed on stopping, to prevent jerking.

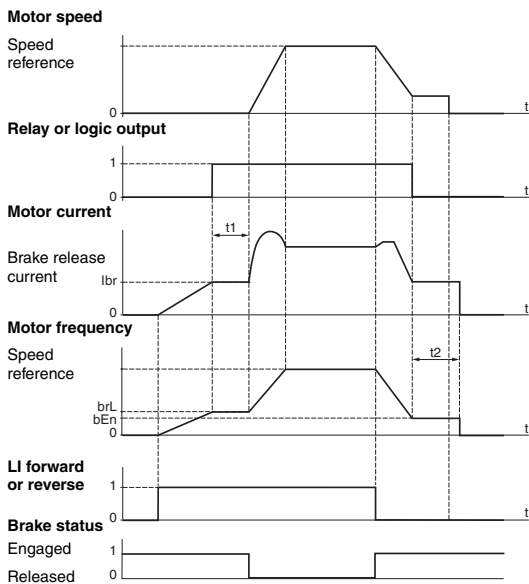

I_{br}: Brake release current
brL: Brake release frequency
bEn: Brake engage frequency

Accessible settings:
t1: Brake release time delay (brt)
t2: Brake engage time delay (bEt)

8800CT0401 brake control.eps

Brake control

Altivar® 31 Adjustable Speed AC Drives Functions

Below are the recommended brake control settings for vertical lifting applications (for a horizontal lifting application, set the current threshold to 0).

- **Brake release current:** Set the brake release current to the nominal current indicated on the motor. If torque is insufficient during testing, increase the brake release current (the drive imposes the maximum value).
- **Acceleration time:** For lifting applications, set the acceleration ramps to more than 0.5 s. Ensure that the drive does not change to current limiting. The same recommendation applies for deceleration.
NOTE: For a lifting movement, a braking resistor must be used. Ensure that the settings and configurations selected cannot cause a drop or a loss of control of the lifted load.
- **Brake release time delay:** This is the time required for the mechanical brake to release. Adjust according to the type of brake.
- **Brake engage frequency:** Set to twice the nominal slip, then adjust based on the result.
- **Brake engage time delay:** This is the time required for the mechanical brake to engage. Adjust according to the type of brake.

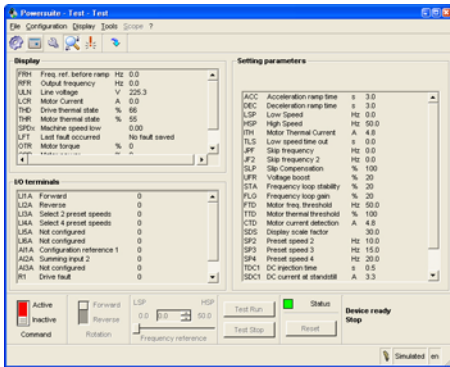

Monitoring parameters with PowerSuite software

Limit switch management

This function manages the operation of one or two limit switches (with one or two rotation directions).

Each limit (forward or reverse) is associated with a logic input. The type of stop occurring on detection of a limit is configurable as normal, freewheel or fast.

Following a stop, the motor can restart only in the opposite direction.

Monitoring

The following data can be displayed:

- frequency reference
- internal PI reference
- frequency reference (absolute value)
- output frequency applied to the motor (value signed in two's complement)
- output value in customer units
- current in the motor
- motor power: 100% = nominal power
- line voltage
- motor thermal state:
100%: nominal thermal state; 118%: motor overload threshold
- drive thermal state:
100%: nominal thermal state; 118%: drive overload threshold
- motor torque: 100% = nominal torque
- last fault
- operating time
- auto-tuning status
- configuration and state of logic inputs
- configuration of analog inputs

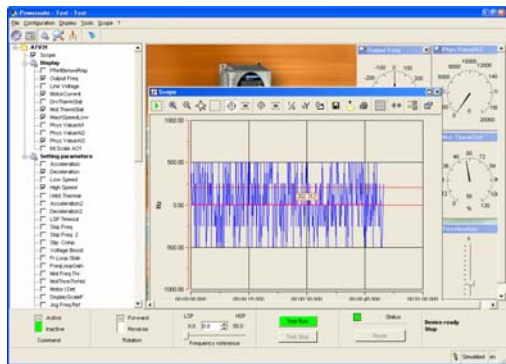

Monitoring parameters with the oscilloscope function in PowerSuite software

Altivar® 31 Adjustable Speed AC Drives Functions

569723



Fault management with PowerSuite software

Fault management

The different modes of operation on a resettable fault are:

- freewheel stop
- switch to the fallback speed
- maintain the speed at which the drive was operating when the fault occurred, until the cause of the fault is removed
- stop on a ramp
- fast stop

The resettable faults detected are:

- drive overheating
- motor overheating
- CANopen bus fault
- Modbus serial link failure
- external faults
- loss of 4–20 mA signal

Fault reset

This function clears the last fault using a logic input. The restart conditions after a reset are the same as those of a normal power-up. This function resets the following faults:

- overvoltage
- overspeed
- external fault
- drive overheating
- motor phase loss
- DC bus overvoltage
- loss of 4–20 mA reference
- overvoltage during deceleration
- serial link
- motor overload, if the thermal state is less than 100%

Line supply undervoltage and line supply phase loss faults are reset automatically when the line supply is restored.

This function is suited to applications where the drives are difficult to access, for example on moving parts in material handling systems.

General reset (reset all faults)

This function inhibits all faults, including thermal protection (forced operation), which can **destroy** the drive.

This function is suited to applications where a restart is vital—such as a conveyor in a furnace, a smoke extraction station, or a machine with hardening products that must be removed.

The function is enabled by a logic input. Fault monitoring is active if the logic input is at state 1. All faults are reset on a change of state \downarrow of the logic input.

Controlled stop on loss of line supply

This function controls the stopping of the motor on a loss of line supply. It is suited to material handling, machines with high inertia, or continuous product processing machines. The types of stop possible are:

- a freewheel stop
- a stop using the mechanical inertia to maintain the drive power supply for as long as possible
- a stop on a ramp
- a fast stop (depends on the inertia and braking ability of the drive)

Stop mode in the event of a fault

The type of stop occurring on fault detection is configurable as normal, freewheel, or fast for the following faults:

- external fault (detection enabled by a logic input or a bit in a Modbus or CANopen control word)
- motor phase loss fault

If using a downstream contactor between the drive and the motor, inhibit the motor phase loss fault.

Automatic catch a spinning load with speed detection (catch on the fly)

This function restarts the motor smoothly after one of the following events, provided that the run command is still present:

- a loss of line supply (or a simple switch off)
- a fault reset or automatic restart
- a freewheel stop

When the drive restarts, it detects the effective speed of the motor. It then restarts on a ramp at this speed and returns to the reference speed. The speed detection time can be up to 1 s depending on the initial deviation. This function is automatically disabled if the brake sequence is configured.

This function is suited to machines where speed loss is negligible during the loss of mains supply (such as machines with high inertia, and fans or pumps driven by residual flow).

Automatic restart

This function enables an automatic drive restart following a fault if operating conditions permit and the cause of the fault has been removed. A series of automatic restart attempts are performed, separated by increasingly longer wait periods: 1 s, 5 s, and 10 s, then 1 minute for the rest.

The relay configured as a fault relay remains activated until the automatic restart is abandoned. The speed reference and the rotation direction must be maintained during the restart process.

If the restart has not occurred once the maximum duration of restart time has elapsed (adjustable from 5 minutes to an unlimited time), the procedure is abandoned, and the drive controller remains locked until power is cycled.

The faults permitting this restart are:

- line supply overvoltage
- motor thermal overload
- drive thermal overload
- DC bus overvoltage
- failure of a line supply phase
- external fault
- loss of 4–20 mA reference
- CANopen bus fault
- Modbus serial link fault
- line supply voltage too low (automatic restart is always active for this fault, even if not configured)

Altivar® 31 Adjustable Speed AC Drives Functions

This function is suited to machines or installations in continuous operation or without monitoring, and where a restart will not endanger equipment or personnel in any way.

Derated operation in the event of an overvoltage

The line voltage monitoring threshold is lowered to 50% of the motor voltage. A line reactor must be used, and drive performance is not guaranteed.

Resetting the fault relay

The fault relay is energized when the drive is powered up and no faults are present.

It contains a C/O common point contact.

The fault is resettable in one of the following ways:

- by powering down until the On LED extinguishes, then switching the power back on
- by assigning a logic input to the Reset Faults function
- by the Automatic Restart function, if configured

Operating time reset to zero

The drive operating time can be reset to zero.

Motor thermal protection

The theoretical temperature rise of the motor is continuously calculated to provide indirect thermal protection.

Motor thermal protection is adjustable from 0.2 to 1.5 times the nominal drive current. This function is suited to applications with self-cooled motors.

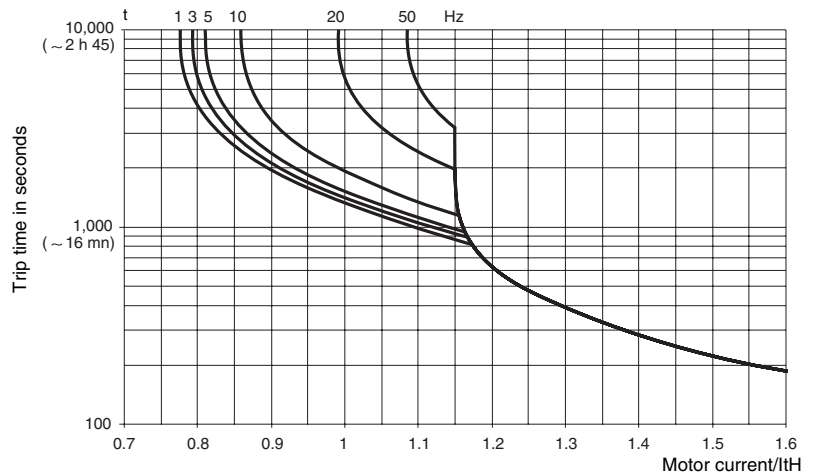

Motor thermal protection curves

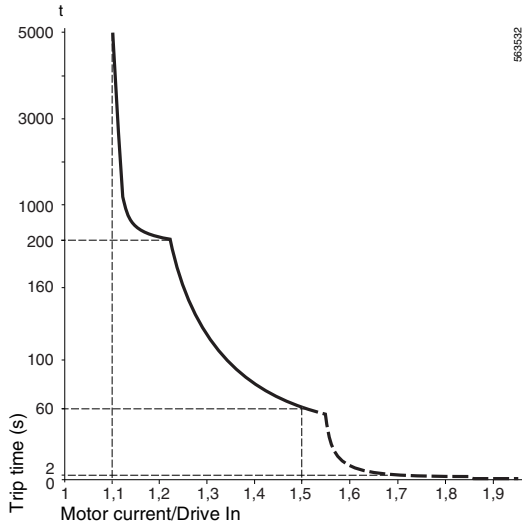

Drive thermal protection

Drive thermal protection

Thermal protection, by a PTC probe fitted on the heatsink or integrated into the power module, ensures that the drive is protected in the event of poor ventilation or excessive ambient temperatures.

The drive stops in the event of a fault.

R1/R2 relay configuration

The following states are signaled by powering up the relay:

- drive faulted
- drive running
- frequency threshold reached
- high speed reached
- current threshold reached
- frequency reference reached
- motor thermal threshold reached
- brake sequence activated (R2 only)

AOC/AOV analog output

The setting of this function modifies the characteristics of the current analog output (AOC) or the voltage analog output (AOV).

AOC: adjustable as 0–20 mA or 4–20 mA

AOV: adjustable as 0–10 V

The same data is available on analog outputs AOC and AOV.

The following assignments are possible:

- motor current
- motor frequency
- motor torque
- power supplied by the drive
- drive fault
- frequency threshold reached
- high speed reached
- current threshold reached
- frequency reference reached
- motor thermal threshold reached
- brake sequence activated

Saving and retrieving the configuration

Saving a configuration to EEPROM allows you to keep a stored configuration in addition to the current one.

Retrieving this configuration clears the current configuration.



Configuring the AOC/AOV outputs in PowerSuite software

Altivar® 31 Adjustable Speed AC Drives

Drives Product Support

Function compatibility table

Configurable I/O

The selection of functions is limited by the number of drive I/O and by the incompatibility of certain functions with one another.

Functions not listed in this table are fully compatible.

Stop functions have priority over run commands.

Functions	Summing Inputs	+/- speed	Limit switch mgmt	Preset speeds	PI regulator	Jog operation	Brake sequence	DC injection stop	Fast stop	Free-wheel stop
Summing inputs		X		↑	X	↑				
+/- Speed	X			X	X	X				
Limit switch management					X					
Preset speeds	←	X			X	↑				
PI regulator	X	X	X	X		X	X			
Jog operation	←	X		←	X		X			
Brake sequence					X	X		X		
DC injection stop							X			↑
Fast stop										↑
Freewheel stop								←	←	

X	Incompatible functions
	Compatible functions
	Not applicable

Priority functions (functions that cannot be active at the same time)

←	The arrow indicates which function has priority Example: the Freewheel stop function has priority over the Fast stop function
↑	

DRIVES PRODUCT SUPPORT

The Product Support Group is staffed from 8 am to 6 pm Eastern time for product selection, start-up assistance, or diagnosis of product problems and advice for the correct course of action. **Emergency phone support** is available 24 hours a day, 365 days a year.

Toll-free: 888-Square D (888-778-2733)

Telephone: 919-266-8600

E-mail: drive.products.support@us.schneider-electric.com

Fax: 919-217-6508

Altivar® 31 Adjustable Speed AC Drives

Schneider Electric
8001 Highway 64 East
Knightdale, NC 27545
1-888-SquareD
(1-888-778-2733)
www.SquareD.com

Schneider Canada Inc.
19 Waterman Avenue,
M4B 1 Y2
Toronto, Ontario
1-800-565-6699
www.schneider-electric.ca

Catalog No. 8800CT0401R10/04 April 2005 © 2004–2005 Schneider Electric All Rights Reserved
Replaces 8800CT0401 dated 3/2004