

Frame Size 42mm/60mm/85mm Hollow Shaft Type Motor

■ Features

- Removable coupling connecting Ball-screw, TM-screw directly
- Remove resonance (vibration, noise) without coupling
- Compact design and light weight with high accuracy, speed and torque
- Suitable for small-sized equipment applications
- Cost-effective



Frame size
42mm

60mm

85mm

⚠ Please read "Safety Considerations" in the instruction manual before using.



■ Dimensions

※ Depending on processing of shaft to be assembled, hollow shaft type can be used both single and dual shaft.

◎ Frame size 42mm

(unit: mm)

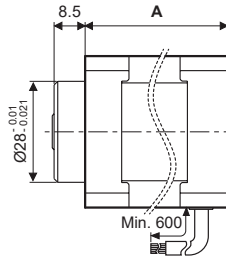
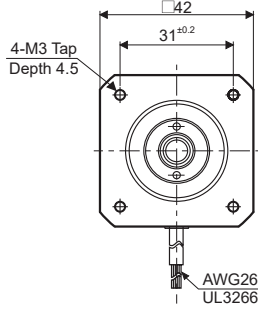

● Hole dimensions

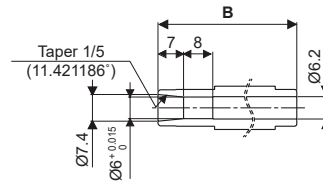

| Model | A | B |
|-------------|----|----|
| AH1K-S543-□ | 33 | 38 |
| AH2K-S544-□ | 39 | 44 |
| AH3K-S545-□ | 47 | 52 |

◎ Frame size 60mm

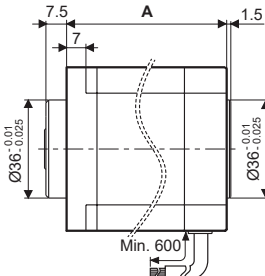
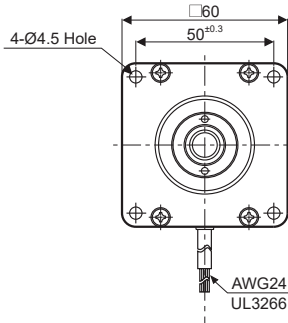

● Hole dimensions

(unit: mm)

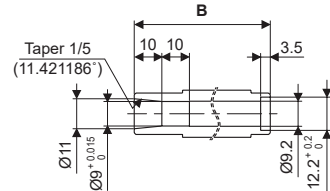

| Model | A | B |
|-----------------|------|------|
| AH4K-□564(W)-□ | 48.5 | 49.3 |
| AH8K-□566(W)-□ | 59.5 | 60.3 |
| AH16K-□569(W)-□ | 89 | 89.8 |

◎ Frame size 85mm

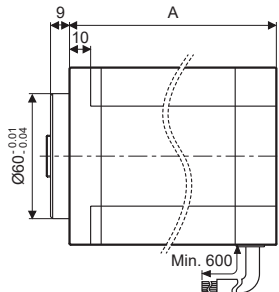
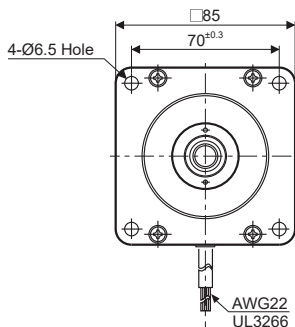

● Hole dimensions

(unit: mm)

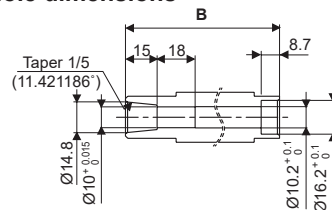

| Model | A | B |
|------------------|-----|-------|
| AH21K-□596(W)-□ | 68 | 73 |
| AH41K-□599(W)-□ | 98 | 102.5 |
| AH63K-□5913(W)-□ | 128 | 133 |

| |
|-----------------------|
| SENSORS |
| CONTROLLERS |
| MOTION DEVICES |
| SOFTWARE |

| |
|--------------------------------|
| (Y) Closed Loop Stepper System |
| (Z) Stepper Motors |
| (AA) Drivers |
| (AB) Motion Controllers |

AHK Series

Characteristic

● AH1K-S543-□

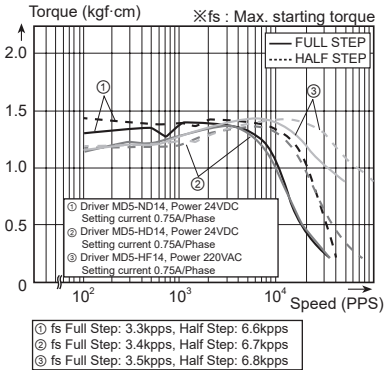

● AH2K-S544-□

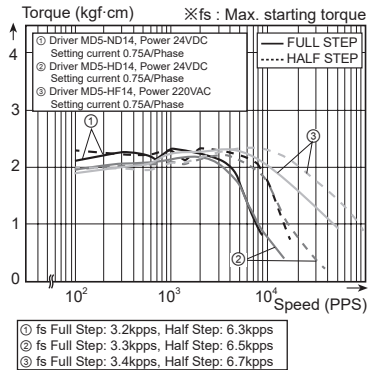

● AH3K-S545-□

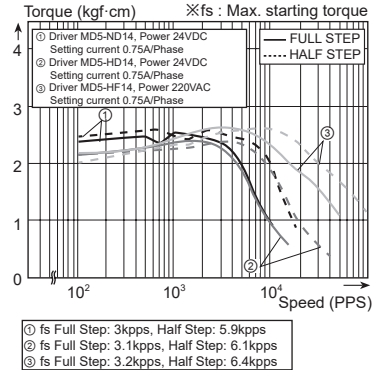

● AH4K-S(M)□564(W)-□

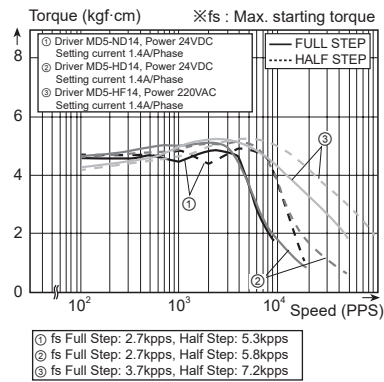

● AH8K-S(M)□566(W)-□

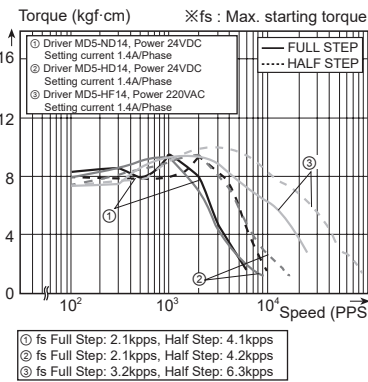

● AH16K-M(G)□569(W)-□

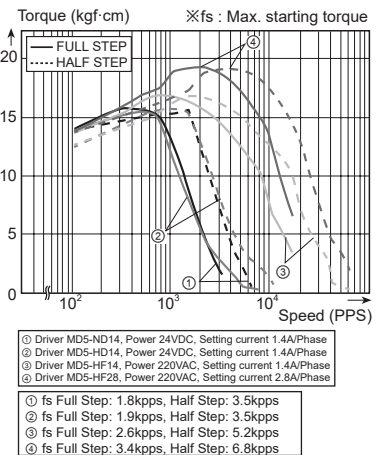

● AH21K-M(G)□596(W)-□

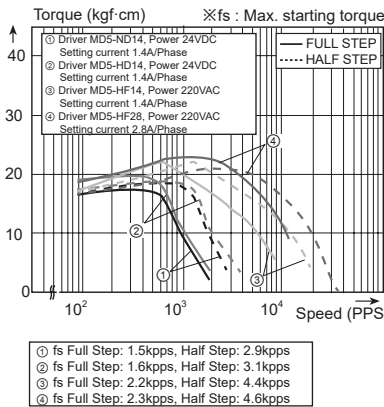

● AH41K-M(G)□599(W)-□

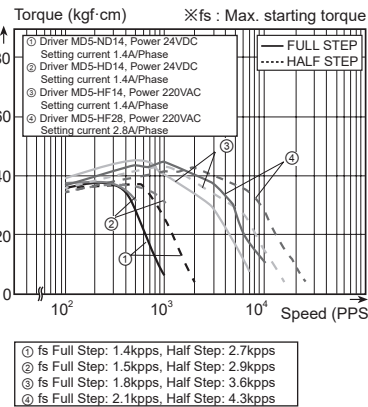

● AH63K-M(G)5913(W)-□

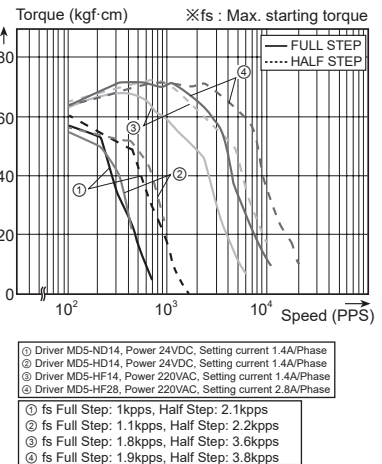

5-Phase Stepper Motor

■ Processing Example for Shaft Assembly

In order to assemble external shafts into Autonics motors, the shafts must be processed as shown in the figures below.

● Single shaft type of frame size 42mm

(unit: mm)

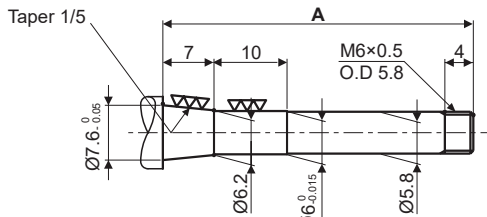

| Model | A |
|-------------|------|
| AH1K-□543-□ | 42.5 |
| AH2K-□544-□ | 48.5 |
| AH3K-□545-□ | 56.5 |

※Lock nut is included.

● Dual shaft type of frame size 42mm

(unit: mm)

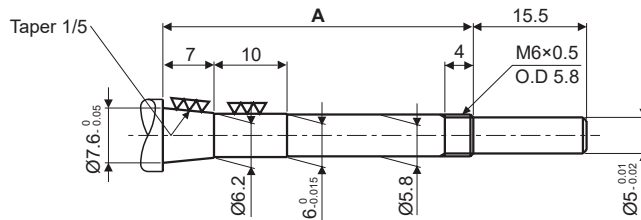

| Model | A |
|--------------|------|
| AH1K-□543W-□ | 42.5 |
| AH2K-□544W-□ | 48.5 |
| AH3K-□545W-□ | 56.5 |

※Lock nut is included.

● Single shaft type of frame size 60mm

(unit: mm)

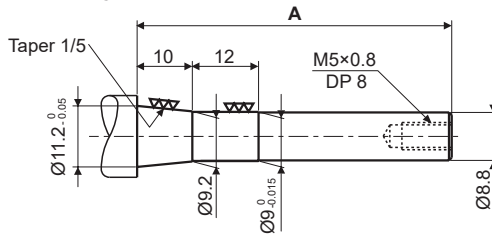

| Model | A |
|--------------|------|
| AH4K-□564-□ | 46 |
| AH8K-□566-□ | 57 |
| AH16K-□569-□ | 86.5 |

※Hexagon wrench bolt, flat washer, spring washer and lock washer are included.

● Dual shaft type of frame size 60mm

(unit: mm)

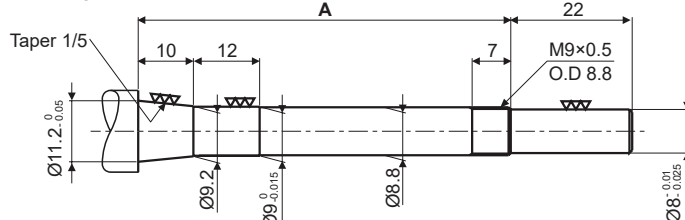

| Model | A |
|---------------|------|
| AH4K-□564W-□ | 56.5 |
| AH8K-□566W-□ | 67.5 |
| AH16K-□569W-□ | 97 |

※Lock nut is included.

● Single shaft type of frame size 85mm

(unit: mm)

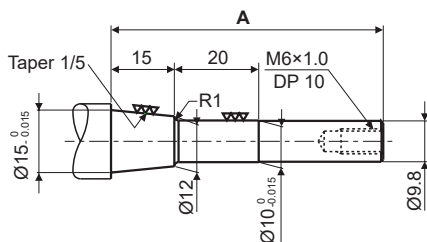

| Model | A |
|---------------|-------|
| AH21K-□596-□ | 64.5 |
| AH41K-□599-□ | 94 |
| AH63K-□5913-□ | 124.5 |

※Hexagon wrench bolt, flat washer, spring washer and lock washer are included.

● Dual shaft type of frame size 85mm

(unit: mm)

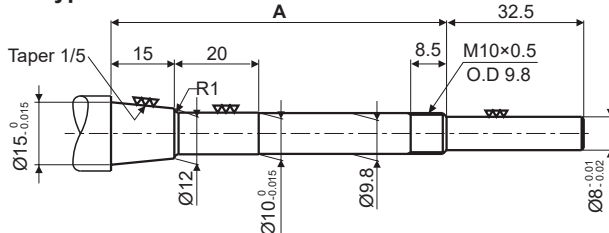

| Model | A |
|----------------|-------|
| AH21K-□596W-□ | 79.5 |
| AH41K-□599W-□ | 109.5 |
| AH63K-□5913W-□ | 139.5 |

※Lock nut is included.

SENSORS

CONTROLLERS

MOTION DEVICES

SOFTWARE

(Y) Closed Loop Stepper System

(Z) Stepper Motors

(AA) Drivers

(AB) Motion Controllers