

ø16 Switches & Pilot Lights

A6 Series

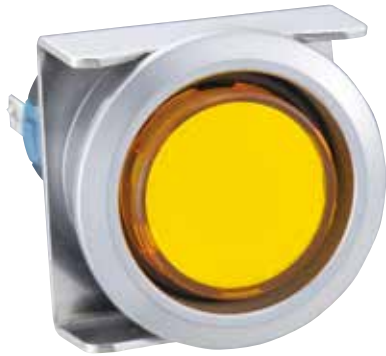

Light duty in short 22 mm body length. Flush bezel accessories can be used to change A6 series to Flush Silhouette switches.



• See website for details on approvals and standards.

Suitable for a wide variety of office and factory applications.

Features IDEC's original mechanism for snap-action switching.

The LED lamp contains a current-limiting resistor and a diode for protection against reverse connection.

Degree of protection: IP40 and IP65 (IEC 60529)

Standard Bezel

A6 SERIES

[Bezel size] [From panel front] [Shape] [Contact rating] [Action] [Operating stroke]

ø18 □18 18×24
 9 mm
 Unibody
 3A
 Light
 3 mm



Flush Bezel

A6 SERIES

[Bezel size] [From panel front] [Shape] [Contact rating] [Action] [Operating stroke]

ø24 □24 18×24
 2 mm
 Unibody
 3A
 Light
 3 mm

Flush bezel accessories provide a sleek updated look. Enables downsizing of equipment.

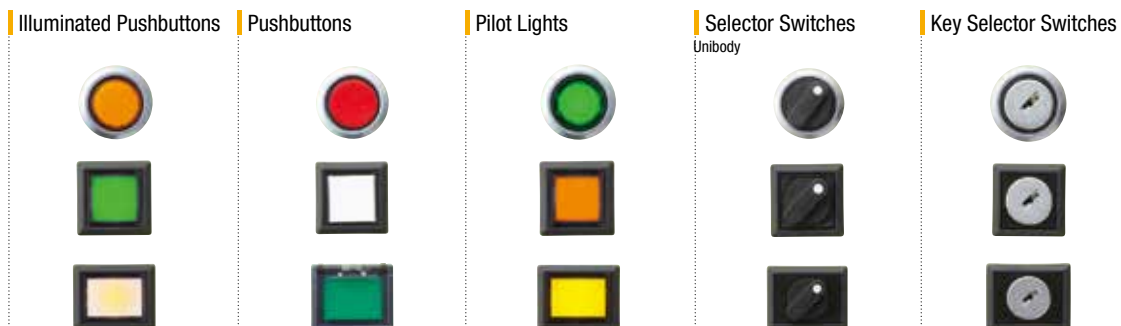

ø16 A6 Series Miniature Switches & Pilot Lights

Light duty in short 22mm body length.



- APEM
- Switches & Pilot Lights
- Control Boxes
- Emergency Stop Switches
- Enabling Switches
- Safety Products
- Explosion Proof
- Terminal Blocks
- Relays & Sockets
- Circuit Protectors
- Power Supplies
- LED Illumination
- Controllers
- Operator Interfaces
- Sensors
- AUTO-ID
- Flush Silhouette
- ø16
- ø22
- ø30
- Miniature
- Pilot Lights
- LB
- A6

Specifications and Ratings

Contact Ratings (Contact Block)

Rated Insulation Voltage		250V			
Rated Thermal Current		3A			
Operating Voltage (AC/DC)		12V	24V	110V	220V
AC 50/60 Hz	Resistive Load	—	—	1.0A	0.5A
	Inductive Load	—	—	0.7A	0.5A
DC	Resistive Load	1.0A	1.0A	0.2A	—
	Inductive Load	0.7A	0.7A	0.1A	—
Contact Material		Gold plated silver			

- Minimum applicable load: 5V AC/DC, 1 mA (applicable range may vary with operating conditions and load types)

Weight (example)

Weight (approx.)	AL6M-M24:	8g
	AL6M-M221:	46g
	AL6M-P4:	6g
	AL6M-P21:	45g
	AB6M-M2:	7g
	AS6M-2Y2:	9g
	AS6M-2KT2A:	21g

Specifications

Operating Temperature		-25 to +55°C (no freezing)
Storage Temperature		-30 to +80°C (no freezing)
Operating Humidity		45 to 85% RH (no condensation)
Contact Resistance		50 mΩ maximum (initial value)
Insulation Resistance		100 MΩ minimum (500V DC megger)
Dielectric Strength	Switch Unit	Between live and dead metal parts: 2,000V AC, 1 minute Between terminals of different poles: 2,000V AC, 1 minute Between terminals of the same pole: 1,000V AC, 1 minute Between contact and lamp terminals: 1,500V AC, 1 minute
	Illumination Unit	Between live part and ground: 2,000V AC, 1 minute
Vibration Resistance		Operating extremes: 5 to 55 Hz, amplitude 0.75 mm
Shock Resistance		Damage limits: 500 m/s ² (50G) Operating extremes: 200 m/s ² (20G)
Mechanical Durability (minimum operations)		Momentary: 1,000,000 operations Maintained: 100,000 operations Pushlock Turn Reset: 100,000 operations Selector Switch: 250,000 operations Key Selector Switch: 250,000 operations
Electrical Durability (minimum operations)		Other than Maintained: 100,000 operations Maintained: 50,000 operations (Switching frequency 1200 operations/h)
Degree of Protection		IP40, IP65 (IEC 60529)
Terminal Style		Solder terminal

LED Lamp Ratings (LATD)

Part No.	LATD-5 ②	LATD-1 ②	LATD-2 ②
Lamp Base	Exclusive for A series control units		
Voltage Range	5V DC ±5%	12V AC/DC ±10%	24V AC/DC ±10%
Rated Voltage	5V DC	12V AC/DC	24V AC/DC
Current Draw	AC	—	9 mA (A, GC, R), 8 mA (JW, SC)
	DC	8 mA (A, G, R), 7 mA (JW, S)	8 mA (A, G, R), 7 mA (JW, S)
Color Code ②	A (amber), G (green), JW (pure white), R (red), S (blue)		
Lamp Base Color	Same as illumination color (except JW - gray base)		
Voltage Marking	Die stamped on the base		
Life (reference value)	Approx. 50,000 hours (The luminance is reduced to 50% of the initial intensity when used on complete DC.)		
Internal Circuit			

- Specify a color code in place of ② in the Part No.
A (amber), G (green), JW (pure white), R (red), S (blue)
- Use a pure white (JW) LED lamp for yellow illumination.

Illuminated Pushbuttons

Package Quantity: 1

Shape	Operation	Operating Voltage	Contact	Part No.		② Illumination Color Code
				IP40	IP65	
Round AL6M 	Momentary	5V DC	SPDT	AL6M-M11②	AL6M-M11P②	
			DPDT	AL6M-M21②	AL6M-M21P②	
		12V AC/DC	SPDT	AL6M-M13②	AL6M-M13P②	
			DPDT	AL6M-M23②	AL6M-M23P②	
		24V AC/DC	SPDT	AL6M-M14②C	AL6M-M14P②C	
			DPDT	AL6M-M24②C	AL6M-M24P②C	
	Maintained	5V DC	SPDT	AL6M-A11②	AL6M-A11P②	
			DPDT	AL6M-A21②	AL6M-A21P②	
		12V AC/DC	SPDT	AL6M-A13②	AL6M-A13P②	
			DPDT	AL6M-A23②	AL6M-A23P②	
		24V AC/DC	SPDT	AL6M-A14②C	AL6M-A14P②C	
			DPDT	AL6M-A24②C	AL6M-A24P②C	
Square AL6Q 	Momentary	5V DC	SPDT	AL6Q-M11②	AL6Q-M11P②	
			DPDT	AL6Q-M21②	AL6Q-M21P②	
		12V AC/DC	SPDT	AL6Q-M13②	AL6Q-M13P②	
			DPDT	AL6Q-M23②	AL6Q-M23P②	
		24V AC/DC	SPDT	AL6Q-M14②C	AL6Q-M14P②C	
			DPDT	AL6Q-M24②C	AL6Q-M24P②C	
	Maintained	5V DC	SPDT	AL6Q-A11②	AL6Q-A11P②	
			DPDT	AL6Q-A21②	AL6Q-A21P②	
		12V AC/DC	SPDT	AL6Q-A13②	AL6Q-A13P②	
			DPDT	AL6Q-A23②	AL6Q-A23P②	
		24V AC/DC	SPDT	AL6Q-A14②C	AL6Q-A14P②C	
			DPDT	AL6Q-A24②C	AL6Q-A24P②C	
Rectangular AL6H 	Momentary	5V DC	SPDT	AL6H-M11②	AL6H-M11P②	
			DPDT	AL6H-M21②	AL6H-M21P②	
		12V AC/DC	SPDT	AL6H-M13②	AL6H-M13P②	
			DPDT	AL6H-M23②	AL6H-M23P②	
		24V AC/DC	SPDT	AL6H-M14②C	AL6H-M14P②C	
			DPDT	AL6H-M24②C	AL6H-M24P②C	
	Maintained	5V DC	SPDT	AL6H-A11②	AL6H-A11P②	
			DPDT	AL6H-A21②	AL6H-A21P②	
		12V AC/DC	SPDT	AL6H-A13②	AL6H-A13P②	
			DPDT	AL6H-A23②	AL6H-A23P②	
		24V AC/DC	SPDT	AL6H-A14②C	AL6H-A14P②C	
			DPDT	AL6H-A24②C	AL6H-A24P②C	
Rectangular w/three-sided barrier AL6G 	Momentary	5V DC	SPDT	AL6G-M11②	AL6G-M11P②	
			DPDT	AL6G-M21②	AL6G-M21P②	
		12V AC/DC	SPDT	AL6G-M13②	AL6G-M13P②	
			DPDT	AL6G-M23②	AL6G-M23P②	
		24V AC/DC	SPDT	AL6G-M14②	AL6G-M14P②	
			DPDT	AL6G-M24②	AL6G-M24P②	
	Maintained	5V DC	SPDT	AL6G-A11②	AL6G-A11P②	
			DPDT	AL6G-A21②	AL6G-A21P②	
		12V AC/DC	SPDT	AL6G-A13②	AL6G-A13P②	
			DPDT	AL6G-A23②	AL6G-A23P②	
		24V AC/DC	SPDT	AL6G-A14②	AL6G-A14P②	
			DPDT	AL6G-A24②	AL6G-A24P②	

Specify a color code in place of ② in the Part No.

A: amber
G: green
JW: pure white
R: red
S: blue
Y: yellow

- See B-151 for dimensions.
- See B-166 for marking plate size and engraving area.
- A pure white (JW) LED lamp is used for yellow illumination.
- Part No. with "C" after the color code uses polycarbonate lens.

Pilot Lights

Package Quantity: 1

Shape	Operating Voltage	Part No.		② Illumination Color Code
		IP40	IP65	
Round AL6M-P 	5V DC	AL6M-P1②	AL6M-P1P②	Specify a color code in place of ② in the Part No. A: amber G: green JW: pure white R: red S: blue Y: yellow
	12V AC/DC	AL6M-P3②	AL6M-P3P②	
	24V AC/DC	AL6M-P4②C	AL6M-P4P②C	
Square AL6Q-P 	5V DC	AL6Q-P1②	AL6Q-P1P②	
	12V AC/DC	AL6Q-P3②	AL6Q-P3P②	
	24V AC/DC	AL6Q-P4②C	AL6Q-P4P②C	
Rectangular AL6H-P 	5V DC	AL6H-P1②	AL6H-P1P②	
	12V AC/DC	AL6H-P3②	AL6H-P3P②	
	24V AC/DC	AL6H-P4②C	AL6H-P4P②C	
Rectangular w/three-sided barrier AL6G-P 	5V DC	AL6G-P1②	AL6G-P1P②	
	12V AC/DC	AL6G-P3②	AL6G-P3P②	
	24V AC/DC	AL6G-P4②	AL6G-P4P②	

- See **B-151** for dimensions.
- See **B-166** for marking plate size and engraving area.
- A pure white (JW) LED lamp is used for yellow illumination.
- Part No. with "C" after the color code uses polycarbonate lens.

APEM

Switches & Pilot Lights

Control Boxes

Emergency Stop Switches

Enabling Switches

Safety Products

Explosion Proof

Terminal Blocks

Relays & Sockets

Circuit Protectors

Power Supplies

LED Illumination

Controllers

Operator Interfaces

Sensors

AUTO-ID

Flush Silhouette

ø16

ø22

ø30

Miniature

Pilot Lights

LB

A6

ø16 A6 Series Miniature Switches & Pilot Lights

Dimensions (Illuminated Pushbuttons & Pilot Lights)

All dimensions in mm.

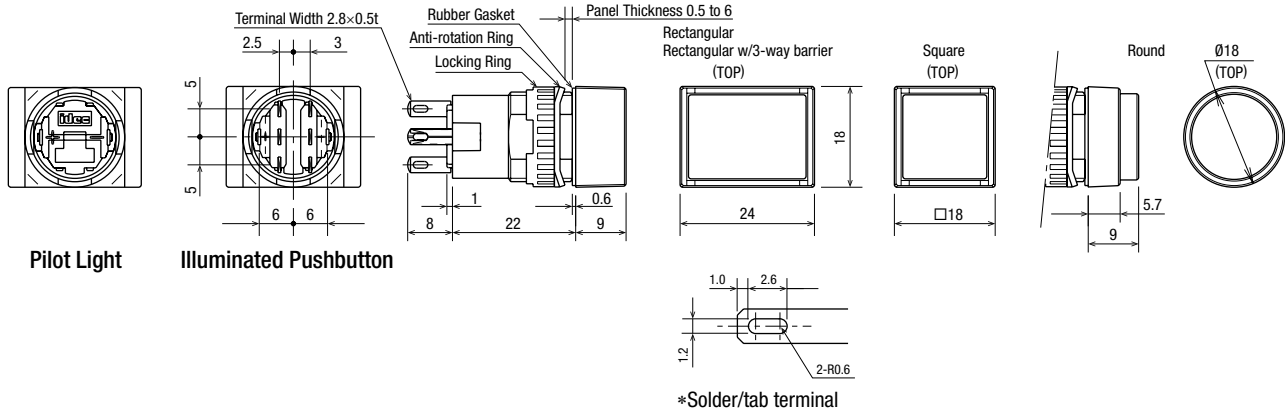

Terminal Arrangement (bottom view)

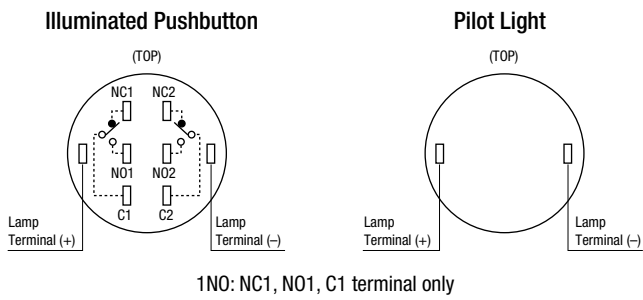



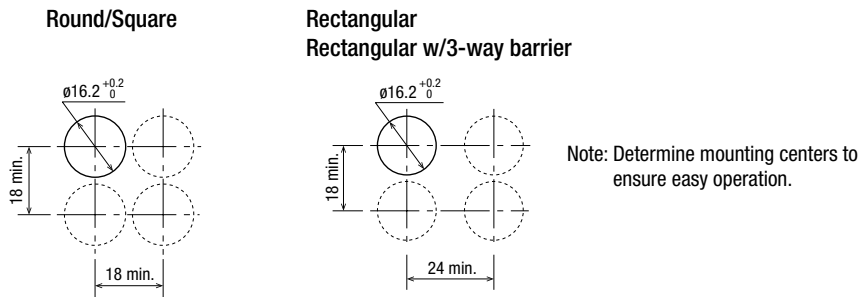

Mounting Hole Layout



- APEM
- Switches & Pilot Lights
- Control Boxes
- Emergency Stop Switches
- Enabling Switches
- Safety Products
- Explosion Proof
- Terminal Blocks
- Relays & Sockets
- Circuit Protectors
- Power Supplies
- LED Illumination
- Controllers
- Operator Interfaces
- Sensors
- AUTO-ID
- Flush Silhouette
- ø16
- ø22
- ø30
- Miniature
- Pilot Lights
- LB
- A6

Pushbuttons

Package Quantity: 1

Shape	Button Style	Operation	Contact	Part No.		Color Code ①②
				IP40	IP65	
Round AB6M 	Button	Momentary	SPDT	AB6M-M1①C	AB6M-M1P①C	B black G: green R: red S: blue W: white Y: yellow
			DPDT	AB6M-M2①C	AB6M-M2P①C	
		Maintained	SPDT	AB6M-A1①C	AB6M-A1P①C	
			DPDT	AB6M-A2①C	AB6M-A2P①C	
	Lens	Momentary	SPDT	AB6M-M1L②	AB6M-M1PL②	A: amber G: green R: red S: blue W: white Y: yellow
			DPDT	AB6M-M2L②	AB6M-M2PL②	
		Maintained	SPDT	AB6M-A1L②	AB6M-A1PL②	
			DPDT	AB6M-A2L②	AB6M-A2PL②	
Square AB6Q 	Button	Momentary	SPDT	AB6Q-M1①C	AB6Q-M1P①C	B black G: green R: red S: blue W: white Y: yellow
			DPDT	AB6Q-M2①C	AB6Q-M2P①C	
		Maintained	SPDT	AB6Q-A1①C	AB6Q-A1P①C	
			DPDT	AB6Q-A2①C	AB6Q-A2P①C	
	Lens	Momentary	SPDT	AB6Q-M1L②	AB6Q-M1PL②	A: amber G: green R: red S: blue W: white Y: yellow
			DPDT	AB6Q-M2L②	AB6Q-M2PL②	
		Maintained	SPDT	AB6Q-A1L②	AB6Q-A1PL②	
			DPDT	AB6Q-A2L②	AB6Q-A2PL②	
Rectangular AB6H 	Button	Momentary	SPDT	AB6H-M1①C	AB6H-M1P①C	B black G: green R: red S: blue W: white Y: yellow
			DPDT	AB6H-M2①C	AB6H-M2P①C	
		Maintained	SPDT	AB6H-A1①C	AB6H-A1P①C	
			DPDT	AB6H-A2①C	AB6H-A2P①C	
	Lens	Momentary	SPDT	AB6H-M1L②	AB6H-M1PL②	A: amber G: green R: red S: blue W: white Y: yellow
			DPDT	AB6H-M2L②	AB6H-M2PL②	
		Maintained	SPDT	AB6H-A1L②	AB6H-A1PL②	
			DPDT	AB6H-A2L②	AB6H-A2PL②	
Rectangular w/three-sided barrier AB6G 	Button	Momentary	SPDT	AB6G-M1①	AB6G-M1P①	B black G: green R: red S: blue W: white Y: yellow
			DPDT	AB6G-M2①	AB6G-M2P①	
		Maintained	SPDT	AB6G-A1①	AB6G-A1P①	
			DPDT	AB6G-A2①	AB6G-A2P①	
	Lens	Momentary	SPDT	AB6G-M1L②	AB6G-M1PL②	A: amber G: green R: red S: blue W: white Y: yellow
			DPDT	AB6G-M2L②	AB6G-M2PL②	
		Maintained	SPDT	AB6G-A1L②	AB6G-A1PL②	
			DPDT	AB6G-A2L②	AB6G-A2PL②	

- Specify a color code in place of ① or ② in the Part No.
- See **B-151** for dimensions.
- See **B-166** for marking plate size and engraving area.
- Black is available for button style buttons. Black lens consists of a clear lens and a black marking plate. Specify "B" in place of ② in the Part No. Example: **AB6H-M2LB**
- Part No. with "C" after the color code uses polycarbonate lens.

APEM

Switches & Pilot Lights

Control Boxes

Emergency Stop Switches

Enabling Switches

Safety Products

Explosion Proof

Terminal Blocks

Relays & Sockets

Circuit Protectors

Power Supplies

LED Illumination

Controllers

Operator Interfaces

Sensors

AUTO-ID

Flush Silhouette

ø16

ø22

ø30

Miniature

Pilot Lights

LB

A6



Dimensions (Pushbuttons)

All dimensions in mm.

Pushbutton

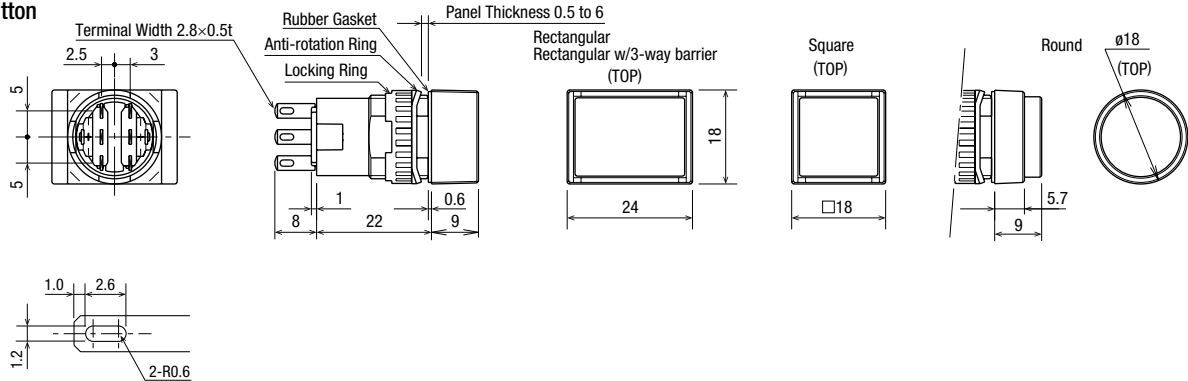

* Solder/Tab Terminal

• See B-164 for lens and button maintenance parts.

Mounting Hole Layout

Round/Square

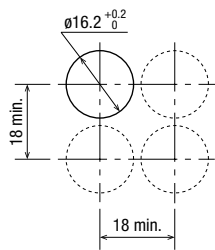

Rectangular w/3-way barrier

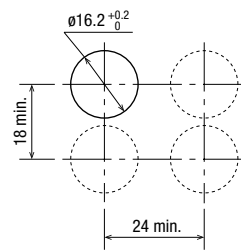

Note: Determine mounting centers to ensure easy operation.

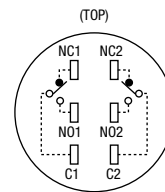
Terminal Arrangement (bottom view)
Pushbutton

Note: SPDT has only NC1, NO1, and C1 terminals.

APEM

Switches &
Pilot Lights

Control Boxes

Emergency
Stop SwitchesEnabling
Switches

Safety Products

Explosion Proof

Terminal Blocks

Relays & Sockets

Circuit
Protectors

Power Supplies

LED Illumination

Controllers

Operator
Interfaces

Sensors

AUTO-ID

Flush Silhouette

ø16

ø22

ø30

Miniature

Pilot Lights

LB

A6

Selector Switches

Operator position can be changed by IDEC's original bezel rotating and locking system. The bezel can be locked at every 45° and bezel rotation is prevented while mounting on a panel.

Example: 3-position

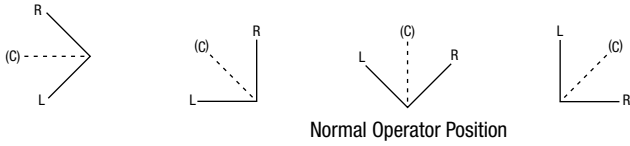

How to change the operator position

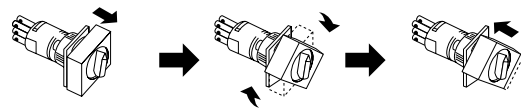

Pull out the bezel to release the lock. Rotate the bezel, and push it in at 45° intervals to lock the bezel.

Package Quantity: 1

Package Quantity: 1

Shape	Position	Contact	Part No.	
			IP40	IP65
 Round AS6M-□Y	90° 2-position	Maintained	SPDT AS6M-2Y1C	AS6M-2Y1PC
		Spring return from right to left	DPDT AS6M-2Y2C	AS6M-2Y2PC
	45° 3-position	Maintained	SPDT AS6M-2Y1C	AS6M-2Y1PC
		Spring return from right to center	DPDT AS6M-2Y2C	AS6M-2Y2PC
		Spring return from left to center	DPDT AS6M-3Y2C	AS6M-3Y2PC
	 Square AS6Q-□Y	90° 2-position	Maintained	SPDT AS6Q-2Y1C
Spring return from right to left			DPDT AS6Q-2Y2C	AS6Q-2Y2PC
45° 3-position		Maintained	SPDT AS6Q-2Y1C	AS6Q-2Y1PC
		Spring return from right to center	DPDT AS6Q-2Y2C	AS6Q-2Y2PC
		Spring return from left to center	DPDT AS6Q-3Y2C	AS6Q-3Y2PC
 Rectangular AS6H-□Y		90° 2-position	Maintained	SPDT AS6H-2Y1C
	Spring return from right to left		DPDT AS6H-2Y2C	AS6H-2Y2PC
	45° 3-position	Maintained	SPDT AS6H-2Y1C	AS6H-2Y1PC
		Spring return from right to center	DPDT AS6H-2Y2C	AS6H-2Y2PC
		Spring return from left to center	DPDT AS6H-3Y2C	AS6H-3Y2PC

- Bezel: black
- Knob: black

Position	Operation	Contact Operation		
		← Left	↑ Center	→ Right
90° 2-position	Maintained	SPDT		
	Spring return from right	DPDT		
45° 3-position	Maintained	DPDT		
	Spring return from right	DPDT		
	Spring return from left	DPDT		
	Two-way return	DPDT		

APEM

Switches & Pilot Lights

Control Boxes

Emergency Stop Switches

Enabling Switches

Safety Products

Explosion Proof

Terminal Blocks

Relays & Sockets

Circuit Protectors

Power Supplies

LED Illumination

Controllers

Operator Interfaces

Sensors

AUTO-ID

Flush Silhouette

ø16

ø22

ø30

Miniature

Pilot Lights

LB

A6

ø16 A6 Series Miniature Switches & Pilot Lights

Dimensions (Selector Switches)

All dimensions in mm.

Dimensions

All dimensions in mm.

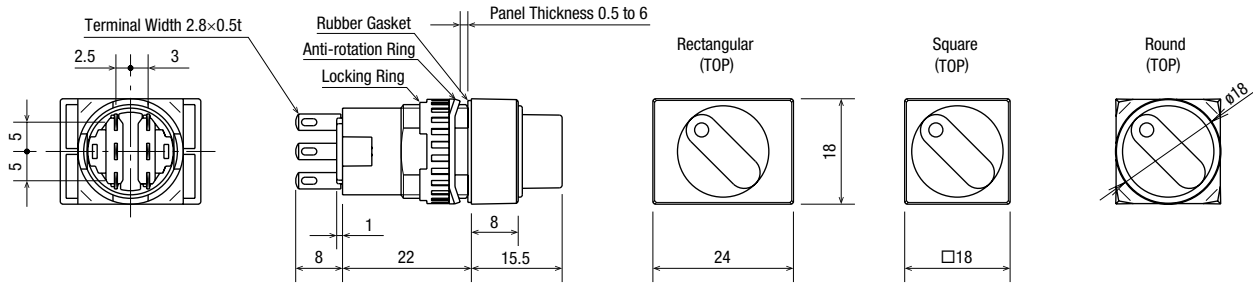

Terminal Arrangement (bottom view) (Selector Switch)

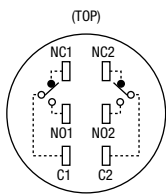

SPDT has NC1, NO1, and C1 only.

Mounting Hole Layout

Round/Square

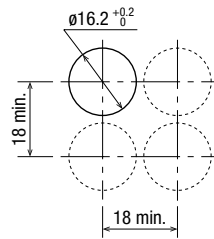

Rectangular

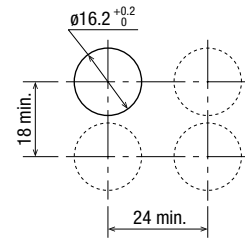

Note: Determine mounting centers to ensure easy operation.



















- APEM
- Switches & Pilot Lights**
- Control Boxes
- Emergency Stop Switches
- Enabling Switches
- Safety Products
- Explosion Proof
- Terminal Blocks
- Relays & Sockets
- Circuit Protectors
- Power Supplies
- LED Illumination
- Controllers
- Operator Interfaces
- Sensors
- AUTO-ID

- Flush Silhouette
- ø16**
- ø22
- ø30
- Miniature
- Pilot Lights

- LB
- A6**









Key Selector Switches

Package Quantity: 1

Shape	Position	Operation	Key Retained at ●	Contact	Part No.				
					IP40	IP65			
Round AS6M 	90° 2-position	Maintained	A		SPDT	AS6M-2KT1AC	AS6M-2KT1PAC		
					DPDT	AS6M-2KT2AC	AS6M-2KT2PAC		
			B		SPDT	AS6M-2KT1BC	AS6M-2KT1PBC		
					DPDT	AS6M-2KT2BC	AS6M-2KT2PBC		
			C		SPDT	AS6M-2KT1CC	AS6M-2KT1PCC		
					DPDT	AS6M-2KT2CC	AS6M-2KT2PCC		
		Spring return from right		B		SPDT	AS6M-21KT1BC	AS6M-21KT1PBC	
				DPDT	AS6M-21KT2BC	AS6M-21KT2PBC			
	45° 3-position		Maintained	A		DPDT	AS6M-3KT2AC	AS6M-3KT2PAC	
				B		DPDT	AS6M-3KT2BC	AS6M-3KT2PBC	
				C		DPDT	AS6M-3KT2CC	AS6M-3KT2PCC	
				D		DPDT	AS6M-3KT2DC	AS6M-3KT2PDC	
		E			DPDT	AS6M-3KT2EC	AS6M-3KT2PEC		
		G			DPDT	AS6M-3KT2GC	AS6M-3KT2PGC		
			Spring return from right		B		DPDT	AS6M-31KT2BC	AS6M-31KT2PBC
					D		DPDT	AS6M-31KT2DC	AS6M-31KT2PDC
					G		DPDT	AS6M-31KT2GC	AS6M-31KT2PGC
			Spring return from left		C		DPDT	AS6M-32KT2CC	AS6M-32KT2PCC
					D		DPDT	AS6M-32KT2DC	AS6M-32KT2PDC
					H		DPDT	AS6M-32KT2HC	AS6M-32KT2PHC
		Spring return two-way		D		DPDT	AS6M-33KT2DC	AS6M-33KT2PDC	

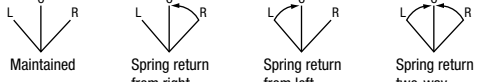
- Key is retained at ● positions and removable at ○ positions.
- Two keys are supplied.
- The front of key cylinder is made of metal.
- Only one type of key is available

Contact Operation

Operator Position & Contact Operation (Top View)				
Positions	Contact	Left	Center	Right
90° 2-position 	SPDT		—	
	DPDT		—	
45° 3-position 	DPDT			

APEM

Switches & Pilot Lights

Control Boxes

Emergency Stop Switches

Enabling Switches

Safety Products

Explosion Proof

Terminal Blocks

Relays & Sockets

Circuit Protectors

Power Supplies

LED Illumination

Controllers

Operator Interfaces

Sensors

AUTO-ID

Flush Silhouette

ø16

ø22

ø30

Miniature

Pilot Lights

Key Selector Switches

Package Quantity: 1

Shape	Position	Operation	Key Retained at ●	Contact	Part No.				
					IP40	IP65			
	90° 2-position	Maintained	A		SPDT	AS6Q-2KT1AC	AS6Q-2KT1PAC		
					DPDT	AS6Q-2KT2AC	AS6Q-2KT2PAC		
			B		SPDT	AS6Q-2KT1BC	AS6Q-2KT1PBC		
					DPDT	AS6Q-2KT2BC	AS6Q-2KT2PBC		
			C		SPDT	AS6Q-2KT1CC	AS6Q-2KT1PCC		
					DPDT	AS6Q-2KT2CC	AS6Q-2KT2PCC		
			Spring return from right	B		SPDT	AS6Q-21KT1BC	AS6Q-21KT1PBC	
					DPDT	AS6Q-21KT2BC	AS6Q-21KT2PBC		
		45° 3-position		Maintained	A		DPDT	AS6Q-3KT2AC	AS6Q-3KT2PAC
					B		DPDT	AS6Q-3KT2BC	AS6Q-3KT2PBC
					C		DPDT	AS6Q-3KT2CC	AS6Q-3KT2PCC
					D		DPDT	AS6Q-3KT2DC	AS6Q-3KT2PDC
	E				DPDT	AS6Q-3KT2EC	AS6Q-3KT2PEC		
	G				DPDT	AS6Q-3KT2GC	AS6Q-3KT2PGC		
	H				DPDT	AS6Q-3KT2HC	AS6Q-3KT2PHC		
			Spring return from right		B		DPDT	AS6Q-31KT2BC	AS6Q-31KT2PBC
					D		DPDT	AS6Q-31KT2DC	AS6Q-31KT2PDC
					G		DPDT	AS6Q-31KT2GC	AS6Q-31KT2PGC
			Spring return from left		C		DPDT	AS6Q-32KT2CC	AS6Q-32KT2PCC
					D		DPDT	AS6Q-32KT2DC	AS6Q-32KT2PDC
		H			DPDT	AS6Q-32KT2HC	AS6Q-32KT2PHC		
		Spring return two-way	D		DPDT	AS6Q-33KT2DC	AS6Q-33KT2PDC		

- Key is retained at ● positions and removable at ○ positions.
- Two keys are supplied.
- The front of key cylinder is made of metal.
- Only one type of key is available.

LB



















A6

Contact Operation

Operator Position & Contact Operation (Top View)					
Positions		Contact	Left	Center	Right
90° 2-position		SPDT		—	
		DPDT		—	
45° 3-position		DPDT			









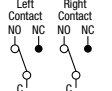

Key Selector Switches

Package Quantity: 1

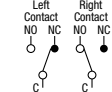
Shape	Position	Operation	Key Retained at ●	Contact	Part No.					
					IP40	IP65				
	90° 2-position	Maintained	A		SPDT	AS6H-2KT1AC	AS6H-2KT1PAC			
					DPDT	AS6H-2KT2AC	AS6H-2KT2PAC			
			B		SPDT	AS6H-2KT1BC	AS6H-2KT1PBC			
					DPDT	AS6H-2KT2BC	AS6H-2KT2PBC			
			C		SPDT	AS6H-2KT1CC	AS6H-2KT1PCC			
					DPDT	AS6H-2KT2CC	AS6H-2KT2PCC			
		Spring return from right		B		SPDT	AS6H-21KT1BC	AS6H-21KT1PBC		
					DPDT	AS6H-21KT2BC	AS6H-21KT2PBC			
	45° 3-position			Maintained	A		DPDT	AS6H-3KT2AC	AS6H-3KT2PAC	
					B		DPDT	AS6H-3KT2BC	AS6H-3KT2PBC	
					C		DPDT	AS6H-3KT2CC	AS6H-3KT2PCC	
					D		DPDT	AS6H-3KT2DC	AS6H-3KT2PDC	
		E			DPDT	AS6H-3KT2EC	AS6H-3KT2PEC			
		G			DPDT	AS6H-3KT2GC	AS6H-3KT2PGC			
			Spring return from right		B		DPDT	AS6H-31KT2BC	AS6H-31KT2PBC	
						D		DPDT	AS6H-31KT2DC	AS6H-31KT2PDC
						G		DPDT	AS6H-31KT2GC	AS6H-31KT2PGC
			Spring return from left		C		DPDT	AS6H-32KT2CC	AS6H-32KT2PCC	
						D		DPDT	AS6H-32KT2DC	AS6H-32KT2PDC
						H		DPDT	AS6H-32KT2HC	AS6H-32KT2PHC
	Spring return two-way		D		DPDT	AS6H-33KT2DC	AS6H-33KT2PDC			

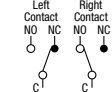
- Key is retained at ● positions and removable at ○ positions.
- Two keys are supplied.
- The front of key cylinder is made of metal.
- Only one type of key is available.

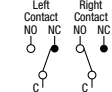
Contact Operation

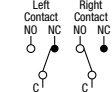
Operator Position & Contact Operation (Top View)				
Positions	Contact	Left	Center	Right
90° 2-position	SPDT		—	
	DPDT		—	
45° 3-position	DPDT			
				
				
				

- APEM
- Switches & Pilot Lights
- Control Boxes
- Emergency Stop Switches
- Enabling Switches
- Safety Products
- Explosion Proof
- Terminal Blocks
- Relays & Sockets
- Circuit Protectors
- Power Supplies
- LED Illumination
- Controllers
- Operator Interfaces
- Sensors
- AUTO-ID
- Flush Silhouette
- ø16
- ø22
- ø30
- Miniature
- Pilot Lights

ø16 A6 Series Miniature Switches & Pilot Lights

Dimensions

All dimensions in mm.

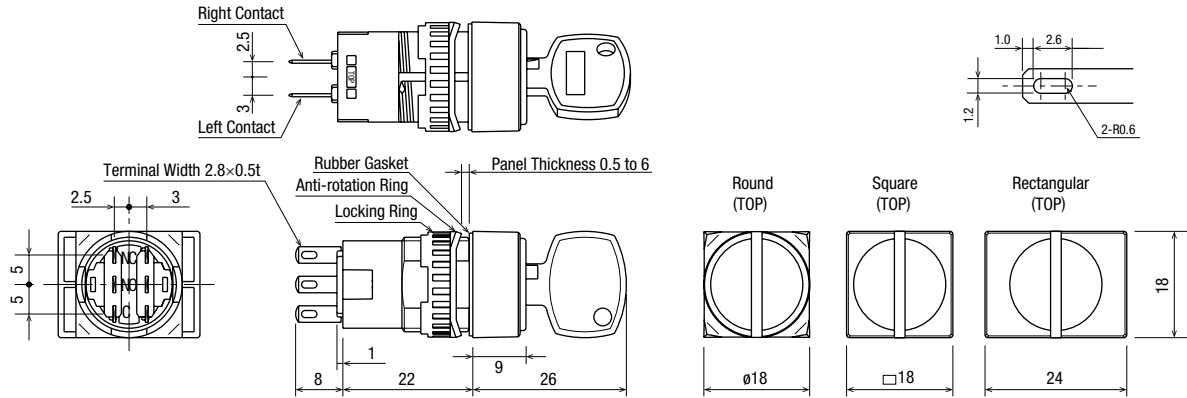

Mounting Hole Layout

Round/Square

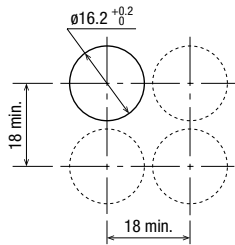

Rectangular

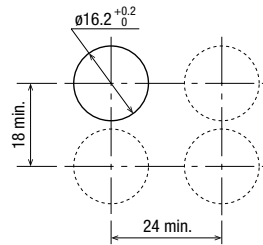

Terminal Arrangement (bottom view)

(Key Selector Switch)

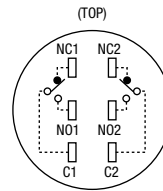

SPDT has NC1, NO1, and C1 only.

Note: Determine mounting centers to ensure easy operation.

Spare Key

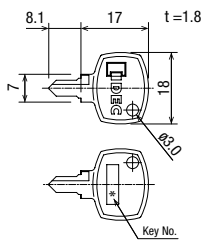

- APEM
- Switches & Pilot Lights
- Control Boxes
- Emergency Stop Switches
- Enabling Switches
- Safety Products
- Explosion Proof
- Terminal Blocks
- Relays & Sockets
- Circuit Protectors
- Power Supplies
- LED Illumination
- Controllers
- Operator Interfaces
- Sensors
- AUTO-ID

- LB
- A6

APEM

Switches & Pilot Lights

Control Boxes

Emergency Stop Switches

Enabling Switches

Safety Products

Explosion Proof

Terminal Blocks

Relays & Sockets

Circuit Protectors

Power Supplies

LED Illumination

Controllers

Operator Interfaces

Sensors

AUTO-ID

Flush Silhouette

ø16

ø22

ø30

Miniature

Pilot Lights

LB

A6

Accessories

All dimensions in mm.

Shape		Material	Part No.	Ordering No.	Package Quantity	Remarks	
		Metal (nickel-plated brass)	MT-001	MT-001	1	• Used to tighten the locking ring when installing A6 control units into a panel.	
		Rubber	OR-77	OR-77	1	• Used to install and remove the LED lamps.	
		Stainless Steel	MT-101	MT-101	1	• Used to install and remove lenses and buttons.	
Switch Guard	[Remains open] For pushbuttons, illuminated pushbuttons 	For round/square units (110°, 180°) 	LB9Z-K2	LB9Z-K2	1	• Degree of protection: IP40 • Used to protect pushbuttons from inadvertent operation.	
	For rectangular units (remains 110°, 180°) 		LB9Z-K3P	LB9Z-K3P	1	• Degree of protection: IP65 • Used to protect pushbuttons from inadvertent operation.	
	[Spring return] For pushbuttons, illuminated pushbuttons 	For round/square units (180°) 	AL-K6S	AL-K6S	1	• Degree of protection: IP40 • Used to protect pushbuttons from inadvertent operation.	
			AL-K6SP	AL-K6SP	1	• Degree of protection: IP65 (when used with IP65 control units) • Used to protect pushbuttons from inadvertent operation.	
			AL-KH6S	AL-KH6S	1	• Degree of protection: IP40 • Used to protect pushbuttons from inadvertent operation.	
	For rectangular units (180°) 	AL-KH6SP	AL-KH6SP	1	• Degree of protection: IP65 (when used with IP65 control units) • Used to protect pushbuttons from inadvertent operation.		
Dust Cover 	① For round units	Translucent cover: elastomer Black part: polypropylene	AL-D6	AL-D6	1	• When mounting the control units with the dust covers installed, refer to mounting hole layout on B-162. • Operating temperature: -10 to +55°C	
	② For square units		AL-DQ6	AL-DQ6	1		
	③ For rectangular units		AL-DH6	AL-DH6	1		
Terminal Cover 		Polyamide (white) See B-162 for dimensions.	AL-V6	AL-V6PN10	10	• When wiring the terminals, insert the lead wires into the terminal cover holes before soldering. • Terminal cover is not attached and must be ordered separately.	
Socket 	① Solder Terminal	See B-162 for dimensions.	AL-C6	AL-C6	1	• Plugs on the rear of the A series control units.	
	② PC Board Terminal		AL-C6V	AL-C6V	1		
Mounting Hole Plug 		Rubber	Nitril rubber (black)	AL-B6	AL-B6PN05	5	• Degree of protection: IP65 
Mounting Hole Plug 		Metal	Plug: metal (diecast) Locking ring: polyacetal Gasket: nitrile	AL-BM6	AL-BM6	1	• Degree of protection: IP65 • Tightening torque: 0.1 to 0.29 N-m. 



ø16 A6 Series Miniature Switches & Pilot Lights

Dimensions

All dimensions in mm.

Switch Guard

[Remains open]

For round/square units (Degree of protection: IP40)
LB9Z-K2

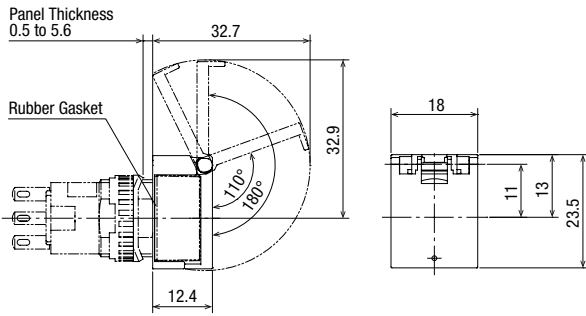

For rectangular units (Degree of protection: IP65)
LB9Z-K3P

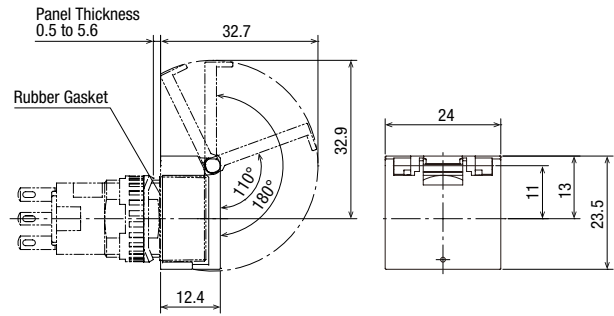

[Spring return]

For round/square units (Degree of protection: IP40)
AL-K6S

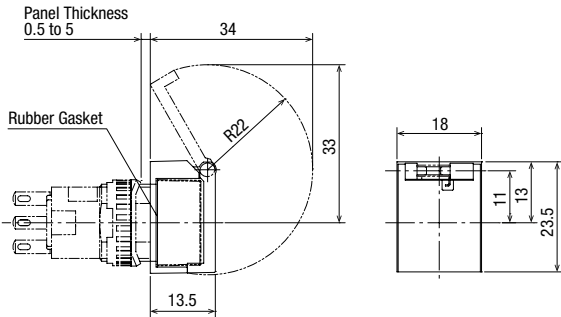

For rectangular units (Degree of protection: IP40)
AL-KH6S

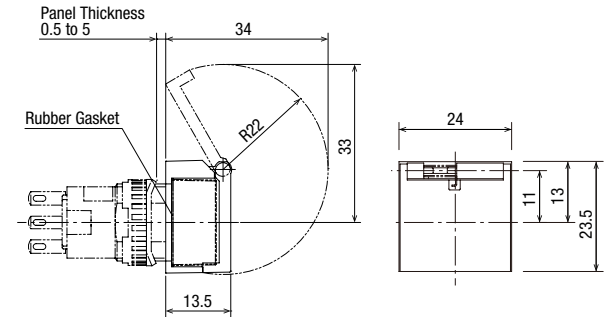

For round/square units (Degree of protection: IP65)
AL-K6SP

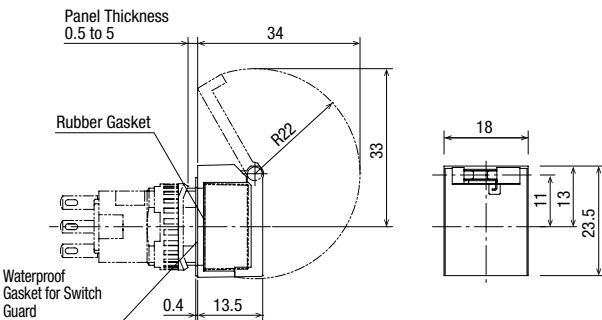

For rectangular units (Degree of protection: IP65)
AL-KH6SP

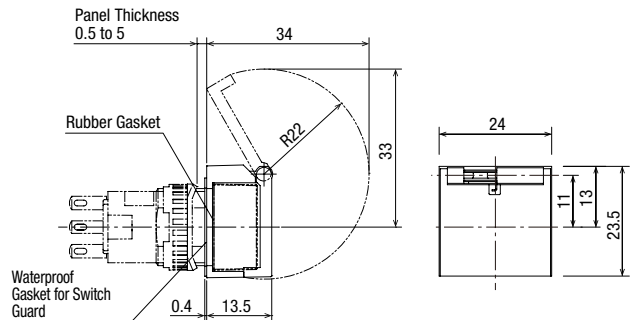

- APEM
- Switches & Pilot Lights
- Control Boxes
- Emergency Stop Switches
- Enabling Switches
- Safety Products
- Explosion Proof
- Terminal Blocks
- Relays & Sockets
- Circuit Protectors
- Power Supplies
- LED Illumination
- Controllers
- Operator Interfaces
- Sensors
- AUTO-ID

- Flush Silhouette
- ø16
- ø22
- ø30
- Miniature
- Pilot Lights
- LB
- A6

- APEM
- Switches & Pilot Lights
- Control Boxes
- Emergency Stop Switches
- Enabling Switches
- Safety Products
- Explosion Proof
- Terminal Blocks
- Relays & Sockets
- Circuit Protectors
- Power Supplies
- LED Illumination
- Controllers
- Operator Interfaces
- Sensors
- AUTO-ID
- Flush Silhouette
- ø16
- ø22
- ø30
- Miniature
- Pilot Lights

- LB
- A6

Dimensions

All dimensions in mm.

Socket

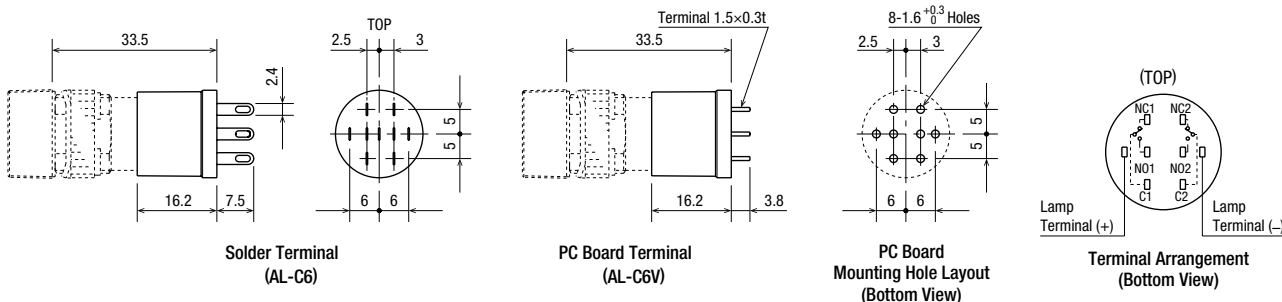

Terminal Cover

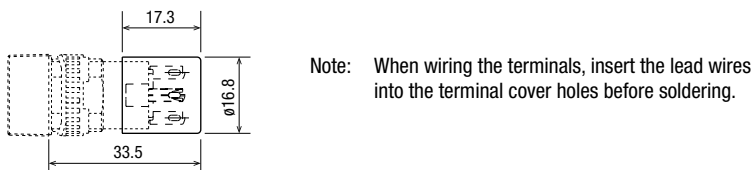

Dust Cover

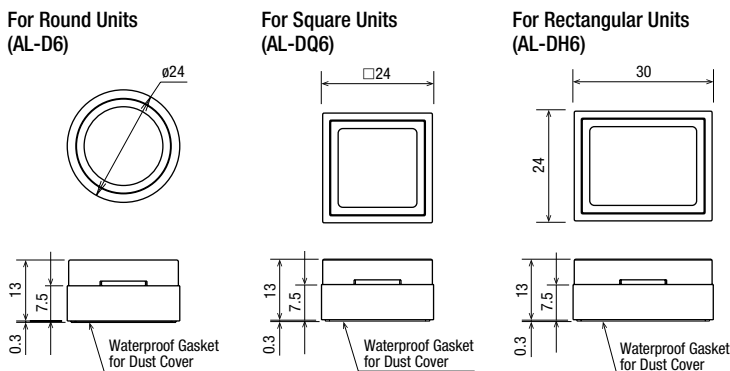

Mounting Hole Centers

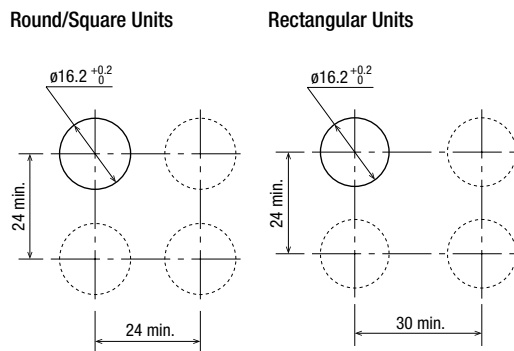

Large Lens and Large Button

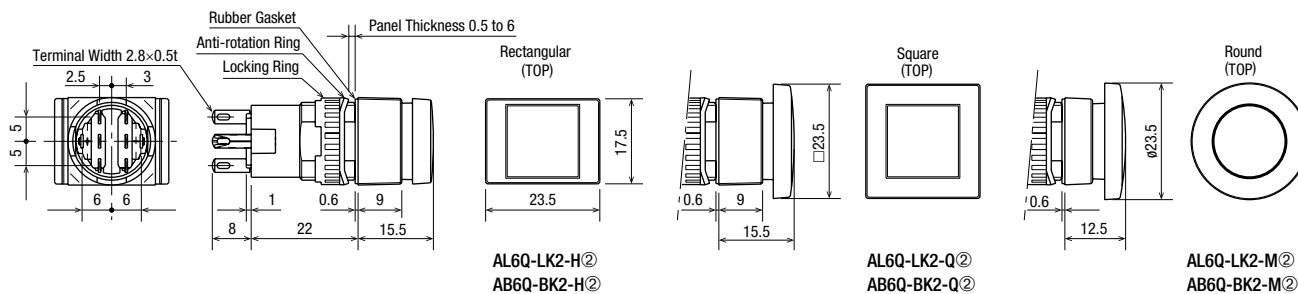

Grip Switch Housing

Grip Style Enabling Switch Housing

The following switches can be installed on the grip style enabling switch housing to be used as hand-held switches.

- AB6M pushbuttons (IP65, except for AB6M-V)
- AS6M selector switches (IP65)
- AS6M key selector switches (IP65)

Note: Illuminated pushbuttons and pilot lights cannot be used. When using HE9Z-GSH51, be sure to use IP65 switches.

Part No.	Ordering No.	Package Quantity
HE9Z-GSH51	HE9Z-GSH51	1

Specifications

Applicable Standards	IEC/EN 60529
Operating Temperature	-25 to 60°C (no freezing)
Relative Humidity	45 to 85% RH (no condensation)
Storage Temperature	-40 to 80°C (no freezing)
Pollution Degree	3
Shock Resistance	Damage limits: 500 m/s ²
Vibration Resistance	Damage limits: 5 to 55 Hz, amplitude 0.5 mm
Electric Shock Protection Class	Class II (when using HE5B-M2P*)
Applicable Cable	Outside diameter ø4.5 to 10 mm
Conduit Port Size	M16 (cable gland is supplied with the grip style enabling switch housing)
Degree of Protection	IP65 (with HE5B-M2P*) NEMA type 4X indoor use only (with HE5B-M2P*)
Weight (approx.)	65g (grip style enabling switch housing only)

- The above specifications are for the grip style enabling switch housing only.



Notes:

- The HE9Z-GSH51 grip style enabling switch housing does not include the HE5B enabling switch. The enabling switch must be ordered separately.
- The HE5B enabling switch must be installed and wired to the HE9Z-GSH51 grip style enabling switch housing by the user. For information on wiring, see the instruction sheet supplied with the HE9Z-GSH51.

Dimensions

HE9Z-GSH51

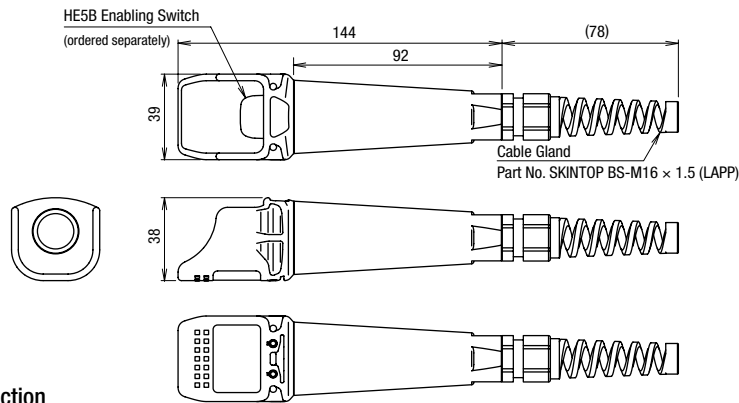

HE9Z-GSH51 + HE5B Construction

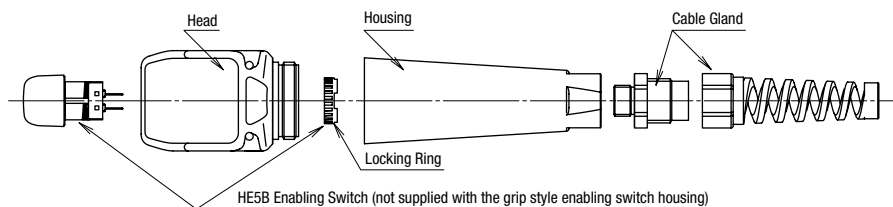

- Anti-rotation ring is not required when installing the HE5B enabling switch on the HE9Z-GSH51 grip style enabling switch housing. Use the locking ring only.

Mounting Bracket

Part No: HE9Z-GH1

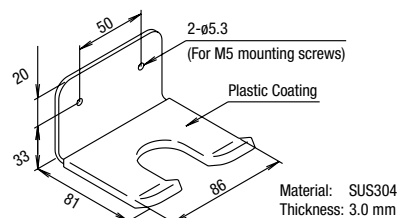

All dimensions in mm.

APEM

Switches & Pilot Lights

Control Boxes

Emergency Stop Switches

Enabling Switches

Safety Products

Explosion Proof

Terminal Blocks

Relays & Sockets

Circuit Protectors

Power Supplies

LED Illumination

Controllers

Operator Interfaces

Sensors

AUTO-ID

Flush Silhouette

ø16

ø22

ø30











Miniature

Pilot Lights

LB

A6

Maintenance Parts

Shape		Specification		Part No.	Ordering No.	Package Quantity	Remarks																	
	Round	Polyarylate		AL6M-L②	AL6M-L②PN05	5	Specify a color code in place of ② in the Part No. A (amber), C (clear), G (green) R (red), S (blue), Y (yellow) • Use a C (clear) lens for JW (pure white) illumination.																	
	Square			AL6Q-L②	AL6Q-L②PN05																			
	Rectangular			AL6H-L②	AL6H-L②PN05																			
	Round	Polyarylate		AB6M-B①	AB6M-B①PN05			1	Specify a color code in place of ① in the Part No. B (black), G (green), R (red) S (blue), W (white), Y (yellow)															
	Square			AB6Q-B①	AB6Q-B①PN05																			
	Rectangular			AB6H-B①	AB6H-B①PN05																			
	Round	Acrylic	White	AL6M-W	AL6M-WPN05					• Specify a color code in place of ② in the Part No. • Degree of protection: IP65 ② Color Code <table border="1" data-bbox="1106 1052 1433 1216"> <thead> <tr> <th>Translucent Color Lens</th> <th>Opaque Button</th> </tr> </thead> <tbody> <tr> <td>A (amber)</td> <td>B (black)</td> </tr> <tr> <td>G (green)</td> <td>G (green)</td> </tr> <tr> <td>R (red)</td> <td>R (red)</td> </tr> <tr> <td>S (blue)</td> <td>S (blue)</td> </tr> <tr> <td>W (white)</td> <td>W (white)</td> </tr> <tr> <td>Y (yellow)</td> <td>Y (yellow)</td> </tr> </tbody> </table> Note: Use a white (W) translucent color lens for pure white (JW) illumination. • See B-162 for dimensions.	Translucent Color Lens	Opaque Button	A (amber)	B (black)	G (green)	G (green)	R (red)	R (red)	S (blue)	S (blue)	W (white)	W (white)	Y (yellow)	Y (yellow)
			Translucent Color Lens	Opaque Button																				
	A (amber)		B (black)																					
	G (green)		G (green)																					
	R (red)		R (red)																					
	S (blue)		S (blue)																					
W (white)	W (white)																							
Y (yellow)	Y (yellow)																							
Black	AL6M-B	AL6M-BPN05																						
Square	White	AL6Q-W	AL6Q-WPN05																					
	Black	AL6Q-B	AL6Q-BPN05																					
Rectangular	White	AL6H-W	AL6H-WPN05																					
	Black	AL6H-B	AL6H-BPN05																					
	Round (installed on round units)	Translucent color lens		AL6M-LK2-M②	AL6M-LK2-M②	1	• Specify a color code in place of ② in the Part No. • Degree of protection: IP65 ② Color Code <table border="1" data-bbox="1106 1052 1433 1216"> <thead> <tr> <th>Translucent Color Lens</th> <th>Opaque Button</th> </tr> </thead> <tbody> <tr> <td>A (amber)</td> <td>B (black)</td> </tr> <tr> <td>G (green)</td> <td>G (green)</td> </tr> <tr> <td>R (red)</td> <td>R (red)</td> </tr> <tr> <td>S (blue)</td> <td>S (blue)</td> </tr> <tr> <td>W (white)</td> <td>W (white)</td> </tr> <tr> <td>Y (yellow)</td> <td>Y (yellow)</td> </tr> </tbody> </table> Note: Use a white (W) translucent color lens for pure white (JW) illumination. • See B-162 for dimensions.	Translucent Color Lens	Opaque Button	A (amber)	B (black)	G (green)	G (green)	R (red)	R (red)	S (blue)	S (blue)	W (white)	W (white)	Y (yellow)	Y (yellow)			
		Translucent Color Lens	Opaque Button																					
	A (amber)	B (black)																						
	G (green)	G (green)																						
	R (red)	R (red)																						
	S (blue)	S (blue)																						
W (white)	W (white)																							
Y (yellow)	Y (yellow)																							
Opaque button		AB6M-BK2-M②	AB6M-BK2-M②																					
Square (installed on square units)	Translucent color lens		AL6Q-LK2-Q②	AL6Q-LK2-Q②																				
	Opaque button		AB6Q-BK2-Q②	AB6Q-BK2-Q②																				
Rectangular (installed on square units)	Translucent color lens		AL6Q-LK2-H②	AL6Q-LK2-H②																				
	Opaque button		AB6Q-BK2-H②	AB6Q-BK2-H②																				
		Polyacetal		HA9Z-LN	HA9Z-LNPN10	10	• Black																	
		Stainless Steel		LB9Z-LP1	LB9Z-LP1PN10																			
	Key selector (disc tumbler key)	Brass with nickel plating		AS6-SK-132	AS6-SK-132PN02	2	• Thickness 1.8 mm																	
	Key selector (wave key)	Diecast zinc alloy (nickel-plated)		LA9Z-SK-□	LA9Z-SK-□PN02	2	• Specify a key number in place of □ in the Part No. 0H: Standard key (reversible) 1H to 2H: Reversible key 3H to 6H: Non-reversible key																	
																								
		Rubber		AP6M-WM	AP6M-WMPN10	10																		

ø16 A6 Series Miniature Switches & Pilot Lights

LED Lamps

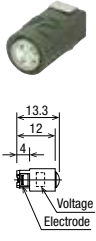
Dimensions	Operating Voltage	Current Draw		Part No.	Ordering No.	② Illumination Color Code	Package Quantity	Base
		AC	DC					
	5V DC ±5%	—	8 mA (A, G, R, W) 7 mA (JW, S)	LATD-5②	LATD-5② LATD-5②PN10	Specify a color code in place of ② in the Ordering No. A: amber G: green JW: pure white R: red S: blue	1	Exclusive for A6 series
	6V DC ±5%	8 mA (A, R, W) 7 mA (G) 6 mA (JW, S)	6 mA (A, R, W) 5 mA (G) 4 mA (JW, S)	LATD-6②	LATD-6② LATD-6②PN10		10	
	12V AC/DC ±10%	9 mA (A, G, R, W) 8 mA (JW, S)	8 mA (A, G, R, W) 7 mA (JW, S)	LATD-1②	LATD-1② LATD-1②PN10		1	
	24V AC/DC ±10%	9 mA (A, G, R, W) 8 mA (JW, S)	8 mA (A, G, R, W) 7 mA (JW, S)	LATD-2②	LATD-2② LATD-2②PN10		10	
							1	

- Use a pure white (JW) LED lamp for yellow illumination

Transformer

Package Quantity: 1

Transformer	Primary Voltage	Secondary Voltage	Part No. (Ordering No.)	Applicable LED
	100/110V AC	±10%	TWR512	LATD-2②
	200/220V AC	±10%	TWR522	
	400/440V AC	±10%	TWR542	

- Terminal cover is supplied as standard.
- Connect only one LATD to a transformer.

Specifications

Operating Voltage	100/110V AC, 200/220V AC, 400/440V AC (50/60Hz)
Current Draw	2.4VA
Rated Insulation Voltage	600V
Insulation Resistance	100 MΩ minimum (500V DC megger)
Operating Temperature	-30 to +60°C (no freezing)
Storage Temperature	-40 to +80°C (no freezing)
Operating Humidity	35 to 85% RH (no condensation)
Vibration Resistance	Damage limits: 30Hz, amplitude 1.5 mm Operating extremes: 5 to 55Hz, amplitude 0.5 mm
Shock Resistance	Damage limits: 1,000 m/s ² Operating extremes: 100 m/s ²
Dielectric Strength	2,500V AC, 1 minute
Terminal Screw	M3.5
Applicable Wire	2 mm ² maximum, 2 wires maximum
Weight (approx.)	87g

Dimensions

All dimensions in mm.

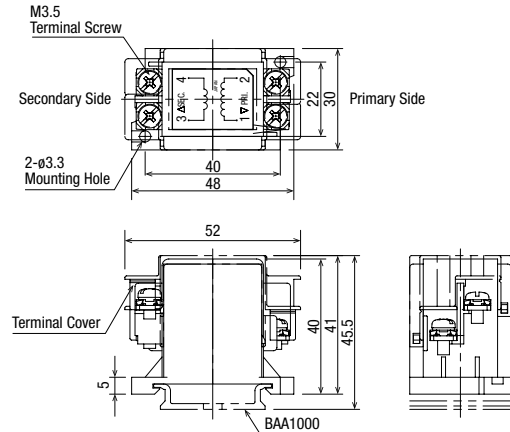

Accessories

When ordering, specify the Ordering No.

Shape	Material	Part No.	Ordering No.	Package Quantity
DIN 35 mm Rail Weight: 200g approx	Aluminum Length: 1000 mm	BAA1000	BAA1000PN10	10
End Clip  Weight: 15g approx	Metal (zinc-plated steel) Applicable rail: BAA1000, BAP1000	BNL6	BNL6PN10	10

- See H-071 for DIN rail products.

Safety Precautions

- Turn off the power to A series control units before starting installation, removal, wiring, maintenance, and inspection of the control units. Failure to turn power off may cause electrical shocks or fire hazard.
- To avoid a burn on your hand, use the lamp holder tool when replacing lamps.

- For wiring, use wires of a proper size to meet the voltage and current requirements. Failure to tighten terminal screws may cause overheating and create a fire hazard.

Operating Instructions

All dimensions in mm.

Replacement of Lens and Marking Plate

Removal

Remove the lens assembly (color lens, marking plate, lens holder, and spring) by holding the color lens recesses with the Lens Removal Tool (MT-101) and pulling it out. Remove the marking plate by disengaging the latches between the color lens and lens holder.

The marking plate must be engraved on the front side as shown at right.

When using a color film, insert it between the color lens and marking plate.

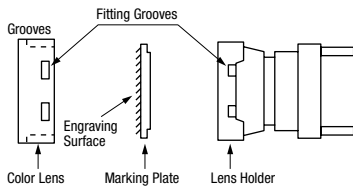

Installation

Place the marking plate on the lens holder in the correct direction, and press the color lens onto the lens holder to engage the latches. Put the spring on the lens holder and insert the lens holder into the housing in the correct direction.

Marking

For A series illuminated pushbuttons, legends and symbols can be engraved on the built-in marking plates, or printed film can be inserted under the lens for labelling purposes.

Marking Plate & Engraving Area

	Round	Square	Rectangular
Built-in Marking Plate and Engraving Area			
	<ul style="list-style-type: none"> • Engraving must be made on the engraving area within 0.5mm deep. • The marking plate is made of white acrylic resin. 		
Applicable Marking Film (not supplied)			
	<ul style="list-style-type: none"> • Thickness = 0.1 mm × 1 film • Recommended film material: polyester 		

Replacing the LED Lamp

Removal

Use the lamp holder tool (OR-77) to remove lamps. Do not use pliers.

Installation

Use the lamp holder tool (OR-77) to install lamps. Note the correct side of the tool for removal or installation.

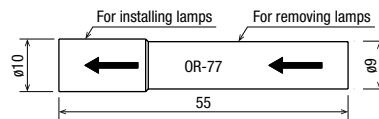

Panel Mounting

When mounting the control units into a panel, use the optional locking ring wrench (MT-001) to tighten the locking ring. Do not use pliers. Tightening torque must not exceed 0.88 N·m. Excessive tightening will damage the locking ring.

Wiring

Solder the terminal at 350°C within 3 seconds using a 60W soldering iron. Sn-Ag-Cu is recommended when using lead-free solder. When soldering, do not touch the control unit with the soldering iron. Also ensure that no tensile force is applied to the terminal. Do not bend the terminal or apply excessive force to the terminal. Use a non-corrosive rosin flux.

Installing the Socket

Install the socket on the control unit with the TOP markings on the control unit and the socket placed in the same direction.

Switch Guard

IP65 (IEC 60529) switch guards must be used with IP65 (IEC 60529) control units only. Even if IP65 type switch guards are installed, enclosed type (IP40) control units are not made waterproof.

Item	Switch Guard		
	IP65 (IEC 60529)	IP65 (IEC 60529)	IP40 (IEC 60529)
Control Unit	IP65	IP65	IP40
	IP40	IP40	IP40



Operating Instructions

All dimensions in mm.

**Opening/closing the Switch Guard
(LB9Z-K2, LB9Z-K3P)**

When opening/closing the switch guard while the switch guard is not installed on a panel, make sure to hold the hinge. Holding the base might result in damage. Also do not apply force on the guard in other than open/close directions, otherwise the hinge may be damaged.

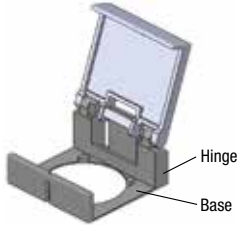
**Selector Switches with Key**

Observe the following instructions to prevent malfunction or damage.

- Insert the key to the bottom of the key hole.
- Do not remove the key from any key retained position.
- Besides the standard key (key number OH), six other key numbers are available. Use a key of the matching number with the key cylinder. The standard key does not have a key number indication.

Operating Voltage of LED Lamps

The operating voltage of 5V DC is measured at complete DC.

Other Notes**Close Proximity Mounting**

When mounting pilot lights or illuminated pushbuttons collectively or lighting them continuously, heat may cause the ambient temperature to rise above the rated operating temperature. When the mounting panel is not made of metal or when the control units are mounted in an enclosed panel, provide for ventilation or lower the operating voltage.

Replacement of Buttons (Illuminated/Non-illuminated)

Do not replace buttons of maintained action units while the button is in the locked position. Replacing the button in the locked position may damage the internal mechanism. Be sure to release the button before replacing.

Operating and Storage Environment

1. Make sure that the operating/storage temperature and humidity are within the ratings.
2. Do not use enclosed type units in an environment subject to oil, water or dust accumulation. In such an area, use the waterproof/oiltight units (IP65).

Microswitch Contacts

Do not connect NO and NC contacts of a microswitch to different voltages or different power sources to prevent a dead short-circuit.

IP65 Units

IP65 units are evaluated by conventional cutting and cooling oils, and can not be used with some special oils. Contact IDEC for resistance against specific oils.

APEM

Switches &
Pilot Lights

Control Boxes

Emergency
Stop SwitchesEnabling
Switches

Safety Products

Explosion Proof

Terminal Blocks

Relays & Sockets

Circuit
Protectors

Power Supplies

LED Illumination

Controllers

Operator
Interfaces

Sensors

AUTO-ID

Flush Silhouette

ø16

ø22

ø30

Miniature

Pilot Lights

LB

A6

Ordering Terms and Conditions

Thank you for using IDEC Products.

By purchasing products listed in our catalogs, datasheets, and the like (hereinafter referred to as "Catalogs") you agree to be bound by these terms and conditions. Please read and agree to the terms and conditions before placing your order.

1. Notes on contents of Catalogs

- (1) Rated values, performance values, and specification values of IDEC products listed in this Catalog are values acquired under respective conditions in independent testing, and do not guarantee values gained in combined conditions.
Also, durability varies depending on the usage environment and usage conditions.
- (2) Reference data and reference values listed in Catalogs are for reference purposes only, and do not guarantee that the product will always operate appropriately in that range.
- (3) The specifications / appearance and accessories of IDEC products listed in Catalogs are subject to change or termination of sales without notice, for improvement or other reasons.
- (4) The content of Catalogs is subject to change without notice.

2. Note on applications

- (1) If using IDEC products in combination with other products, confirm the applicable laws / regulations and standards.
Also, confirm that IDEC products are compatible with your systems, machines, devices, and the like by using under the actual conditions. IDEC shall bear no liability whatsoever regarding the compatibility with IDEC products.
- (2) The usage examples and application examples listed in Catalogs are for reference purposes only. Therefore, when introducing a product, confirm the performance and safety of the instruments, devices, and the like before use. Furthermore, regarding these examples, IDEC does not grant license to use IDEC products to you, and IDEC offers no warranties regarding the ownership of intellectual property rights or non-infringement upon the intellectual property rights of third parties.
- (3) When using IDEC products, be cautious when implementing the following.
 - i. Use of IDEC products with sufficient allowance for rating and performance
 - ii. Safety design, including redundant design and malfunction prevention design that prevents other danger and damage even in the event that an IDEC product fails
 - iii. Wiring and installation that ensures the IDEC product used in your system, machine, device, or the like can perform and function according to its specifications
- (4) Continuing to use an IDEC product even after the performance has deteriorated can result in abnormal heat, smoke, fires, and the like due to insulation deterioration or the like. Perform periodic maintenance for IDEC products and the systems, machines, devices, and the like in which they are used.
- (5) IDEC products are developed and manufactured as general-purpose products for general industrial products. They are not intended for use in the following applications, and in the event that you use an IDEC product for these applications, unless otherwise agreed upon between you and IDEC, IDEC shall provide no guarantees whatsoever regarding IDEC products.
 - i. Use in applications that require a high degree of safety, including nuclear power control equipment, transportation equipment (railroads / airplanes / ships / vehicles / vehicle instruments, etc.), equipment for use in outer space, elevating equipment, medical instruments, safety devices, or any other equipment, instruments, or the like that could endanger life or human health
 - ii. Use in applications that require a high degree of reliability, such as provision systems for gas / waterworks / electricity, etc., systems that operate continuously for 24 hours, and settlement systems
 - iii. Use in applications where the product may be handled or used deviating from the specifications or conditions / environment listed in the Catalogs, such as equipment used outdoors or applications in environments subject to chemical pollution or electromagnetic interference
If you would like to use IDEC products in the above applications, be sure to consult with an IDEC sales representative.

3. Inspections

We ask that you implement inspections for IDEC products you purchase without delay, as well as thoroughly keep in mind management/maintenance regarding handling of the product before and during the inspection.

4. Warranty

- (1) Warranty period
The warranty period for IDEC products shall be one (1) year after purchase or delivery to the specified location. However, this shall not apply in cases where there is a different specification in the Catalogs or there is another agreement in place between you and IDEC.
- (2) Warranty scope
Should a failure occur in an IDEC product during the above warranty period for reasons attributable to IDEC, then IDEC shall replace or repair that product, free of charge, at the purchase location / delivery location of the product, or an IDEC service base. However, failures caused by the following reasons shall be deemed outside the scope of this warranty.
 - i. The product was handled or used deviating from the conditions / environment listed in the Catalogs
 - ii. The failure was caused by reasons other than an IDEC product
 - iii. Modification or repair was performed by a party other than IDEC
 - iv. The failure was caused by a software program of a party other than IDEC
 - v. The product was used outside of its original purpose
 - vi. Replacement of maintenance parts, installation of accessories, or the like was not performed properly in accordance with the user's manual and Catalogs
 - vii. The failure could not have been predicted with the scientific and technical standards at the time when the product was shipped from IDEC
 - viii. The failure was due to other causes not attributable to IDEC (including cases of force majeure such as natural disasters and other disasters)Furthermore, the warranty described here refers to a warranty on the IDEC product as a unit, and damages induced by the failure of an IDEC product are excluded from this warranty.

5. Limitation of liability

The warranty listed in this Agreement is the full and complete warranty for IDEC products, and IDEC shall bear no liability whatsoever regarding special damages, indirect damages, incidental damages, or passive damages that occurred due to an IDEC product.

6. Service scope

The prices of IDEC products do not include the cost of services, such as dispatching technicians. Therefore, separate fees are required in the following cases.

- (1) Instructions for installation / adjustment and accompaniment at test operation (including creating application software and testing operation, etc.)
- (2) Maintenance inspections, adjustments, and repairs
- (3) Technical instructions and technical training
- (4) Product tests or inspections specified by you

The above content assumes transactions and usage within your region. Please consult with an IDEC sales representative regarding transactions and usage outside of your region. Also, IDEC provides no guarantees whatsoever regarding IDEC products sold outside your region.

IDEC CORPORATION

Head Office

6-64, Nishi-Miyahara-2-Chome, Yodogawa-ku, Osaka 532-0004, Japan

USA	IDEC Corporation	Tel: +1-408-747-0550	opencontact@idec.com
Germany	APEM GmbH	Tel: +49-40-25 30 54-0	service@eu.idec.com
Singapore	IDEC Izumi Asia Pte. Ltd.	Tel: +65-6746-1155	info@sg.idec.com
Thailand	IDEC Asia (Thailand) Co., Ltd	Tel: +66-2-392-9765	sales@th.idec.com
India	IDEC Controls India Private Limited	Tel: +91-80679-35328	info_india@idec.com
Taiwan	IDEC Taiwan Corporation	Tel: +886-2-2577-6938	service@tw.idec.com

Hong Kong	IDEC Izumi (H.K.) Co., Ltd.	Tel: +852-2803-8989	info@hk.idec.com
China	IDEC (Shanghai) Corporation	Tel: +86-21-6135-1515	idec@cn.idec.com
	Beijing Branch	Tel: +86-10-6581-6131	idec@cn.idec.com
	Guangzhou Branch	Tel: +86-20-8362-2394	idec@cn.idec.com
Japan	IDEC Corporation	Tel: +81-6-6398-2527	jp_marketing@idec.com

 www.idec.com

Specifications and other descriptions in this brochure are subject to change without notice.

