

## Space-saving Design Ideal for Control Panel Downsizing. Easy Maintenance.

- Compact: 49.4 × 38 × 84 mm (H×W×D).
- Easy identification of operating status with LED operation indicator.
- Independent DPDT contacts on 11-Pin Models.
- CE marking and UL/CSA compliance.



 Refer to *Safety Precautions for Floatless Level Controllers.*

## Model Number Legend

61F-GP-□□  
1 2

### 1. No. of Pins

N: 11 pins  
N8: 8 pins

### 2. Type

Blank: General-purpose  
L 2KM: Long-distance (for 2 km)  
L 4KM: Long-distance (for 4 km)  
H: High-sensitivity  
D: Low-sensitivity  
R: Two-wire  
T: High-temperature

Position of LED indicator

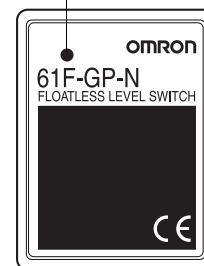

## Ordering Information

Type	General-purpose	Long-distance (for 2 km)	Long-distance (for 4 km)
	Model	Model	Model
11-pin	61F-GP-N	61F-GP-NL 2KM	61F-GP-NL 4KM

Type	High-sensitivity	Low-sensitivity	Two-wire
	Model	Model	Model
11-pin	61F-GP-NH	61F-GP-ND	61F-GP-NR

Type	Tropical environments	High-temperature
	Model	Model
11-pin	61F-GP-N-TDL	61F-GP-NT

Type	General-purpose	Long-distance (for 2 km)	Long-distance (for 4 km)
	Model	Model	Model
8-pin	61F-GP-N8	61F-GP-N8L 2KM	61F-GP-N8L 4KM

Type	High-sensitivity	Low-sensitivity	Two-wire
	Model	Model	Model
8-pin	61F-GP-N8H	61F-GP-N8D	61F-GP-N8R
	61F-GP-N8HY		

**Note:** When ordering, specify the desired operating voltage at the end of the model number.

Example: 61F-GP-N [220 VAC]

\_\_\_\_\_ Desired supply voltage

## ■ Compact Plug-in Models (11-pin Type)

### Specifications

Item	General-purpose Controller 61F-GP-N	High-temperature Controller 61F-GP-NT	Long-distance Controllers 61F-GP-NL 2KM (for 2 km) 61F-GP-NL 4KM (for 4 km)	High-sensitivity Controller 61F-GP-NH (see note 4)	Low-sensitivity Controller 61F-GP-ND	Two-wire Controller 61F-GP-NR
<b>Controlling materials and operating conditions</b>	For control of ordinary purified water or sewage water	For control of ordinary purified water or sewage where operating ambient temperature is high.	For control of ordinary purified water in cases where the distance between sewage pumps and water tanks or between receiver tanks and supply tanks is long or where remote control is required.	For control of liquids with high specific resistance such as distilled water	For control of liquids with low specific resistance such as salt water, sewage water, acid chemicals, alkali chemicals	For control of ordinary purified water or sewage water used in combination with Two-wire Electrode Holder (incorporating a resistor of 6.8 kΩ)
<b>Supply voltage</b>	24, 100, 110, 120, 200, 220, 230 or 240 VAC; 50/60 Hz					
<b>Operating voltage range</b>	85% to 110% of rated voltage					
<b>Interelectrode voltage</b>	8 VAC					
<b>Interelectrode current</b>	Approx. 1 mA AC max.			Approx. 0.12 mA AC max.	Approx. 1 mA AC max.	
<b>Power consumption</b>	Approx. 3.5 VA max.					
<b>Interelectrode operate resistance</b>	0 to approx. 4 kΩ	0 to approx. 4 kΩ	0 to approx. 1.3 kΩ (for 2 km) 0 to approx. 0.5 kΩ (for 4 km)	Approx. 10 kΩ to approx. 40 kΩ (see note 3)	0 to approx. 1.3 kΩ	0 to approx. 2 kΩ
<b>Interelectrode release resistance</b>	Approx. 15 k to ∞ Ω	Approx. 15 k to ∞ Ω	4 k to ∞ Ω (for 2 km) 2.5 k to ∞ Ω (for 4 km)	Approx. 100 k to ∞ Ω	Approx. 4 k to ∞ Ω	Approx. 15 k to ∞ Ω
<b>Response time</b>	Operate:80 ms max. Release:160 ms max.					
<b>Cable length (see note 1)</b>	1 km max.	600 m max.	2 km max. 4 km max.	50 m max.	1 km max.	800 m max.
<b>Control output</b>	1 A, 250 VAC (Inductive load: $\cos\phi = 0.4$ ) 3 A, 250 VAC (Resistive load)					
<b>Ambient temperature</b>	Operating: -10 to 55°C (-10 to 70°C for high-temperature controller)					
<b>Ambient humidity</b>	Operating:45% to 85% RH					
<b>Insulation resistance (see note 2)</b>	100 MΩ min. (at 500 VDC)					
<b>Dielectric strength (see note 2)</b>	2000 VAC, 50/60 Hz for 1 min.					
<b>Life expectancy</b>	Electrical: 100,000 operations min. Mechanical: 5,000,000 operations min.					
<b>Weight</b>	Approx. 155 g					
<b>Accessories</b>	Hold-down clip PFC-N8					
<b>Approved standards</b>	UL508, CSA C22.2 No.14, EN61010-1, EN61326-1 Industrial electromagnetic environment					

**Note: 1.** The length when using completely insulated, 600-V, 3-conductor (0.75 mm<sup>2</sup>) cable cables. Usable cable lengths will become shorter as the cable diameter or number of conductors becomes larger. For details, refer to *Safety Precautions for Floatless Level Controllers*.

**2.** The insulation resistance and dielectric strength indicate values between power terminals and Electrode terminals, between power terminals and contact terminals, and between Electrode terminals and contact terminals. For details, refer to *Safety Precautions for Floatless Level Controllers*.

**3.** Possible to use with 15 kΩ or less, however, this may cause reset failure.

**4.** 61F-GP-NH High-sensitivity Controller uses advanced operation.

When the power supply voltage is applied, if there are some liquids between the electrodes (ground and operation electrodes), the internal relay will not operate.

When the power supply voltage is applied, if there are no liquids between the electrodes (ground and operation electrodes), the internal relay will operate.

If the advanced operation does not satisfy applications, consider using 61F-N8HY controller which uses sequential operation.

## Internal Circuit Diagrams

### 61F-GP-N/-NT/-NL/-ND

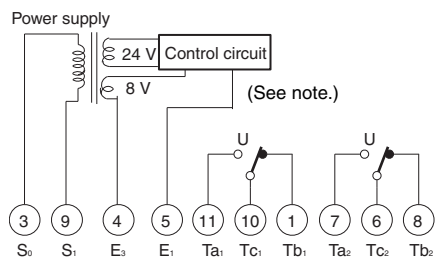

### 61F-GP-NH

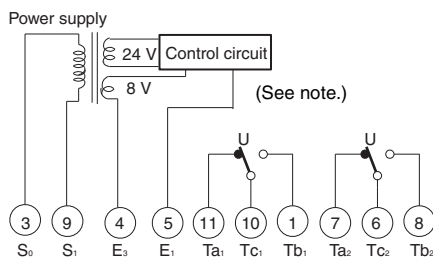

### 61F-GP-NR

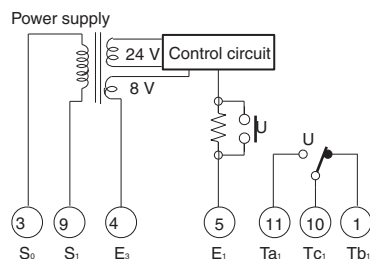

**Note:** When applying a self-holding circuit, short between terminals 5 and 6 and use terminal 7 as E<sub>2</sub>.

# Connections

## Automatic Water Supply and Drainage Control

## Compact, Plug-in Type 61F-GP-N

Dimensions:  
page 14



Automatic Water Supply Control	Automatic Drainage Control
<p><b>Connections</b></p> <p><b>Note:</b> Be sure to ground the common Electrode E<sub>3</sub> (the longest Electrode).</p> <p><b>Connection Sockets</b> PF113A (Front-connecting) PL11 (Rear-connecting)</p> <p>Connect terminal 1 to the contactor's coil terminal.</p> <p><b>Note:</b> The power supply depends on the specifications of the model.</p>	<p><b>Connections</b></p> <p><b>Note:</b> Be sure to ground the common Electrode E<sub>3</sub> (the longest Electrode).</p> <p><b>Connection Sockets</b> PF113A (Front-connecting) PL11 (Rear-connecting)</p> <p>Connect terminal 1 to the contactor's coil terminal.</p> <p><b>Note:</b> The power supply depends on the specifications of the model.</p>
<p><b>Principles of Operation</b></p> <p>The pump stops when the water level reaches E<sub>1</sub> (indicator ON) and starts when the water level drops below E<sub>2</sub> (indicator OFF).</p>	<p><b>Principles of Operation</b></p> <p>The pump starts when the water level reaches E<sub>1</sub> (indicator ON) and stops when the water level drops below E<sub>2</sub> (indicator OFF).</p>

## Liquid Level Indication (Connection Example)

## Compact, Plug-in Type 61F-GP-N

Dimensions:  
page 14



### Liquid Level Indication

#### Connections

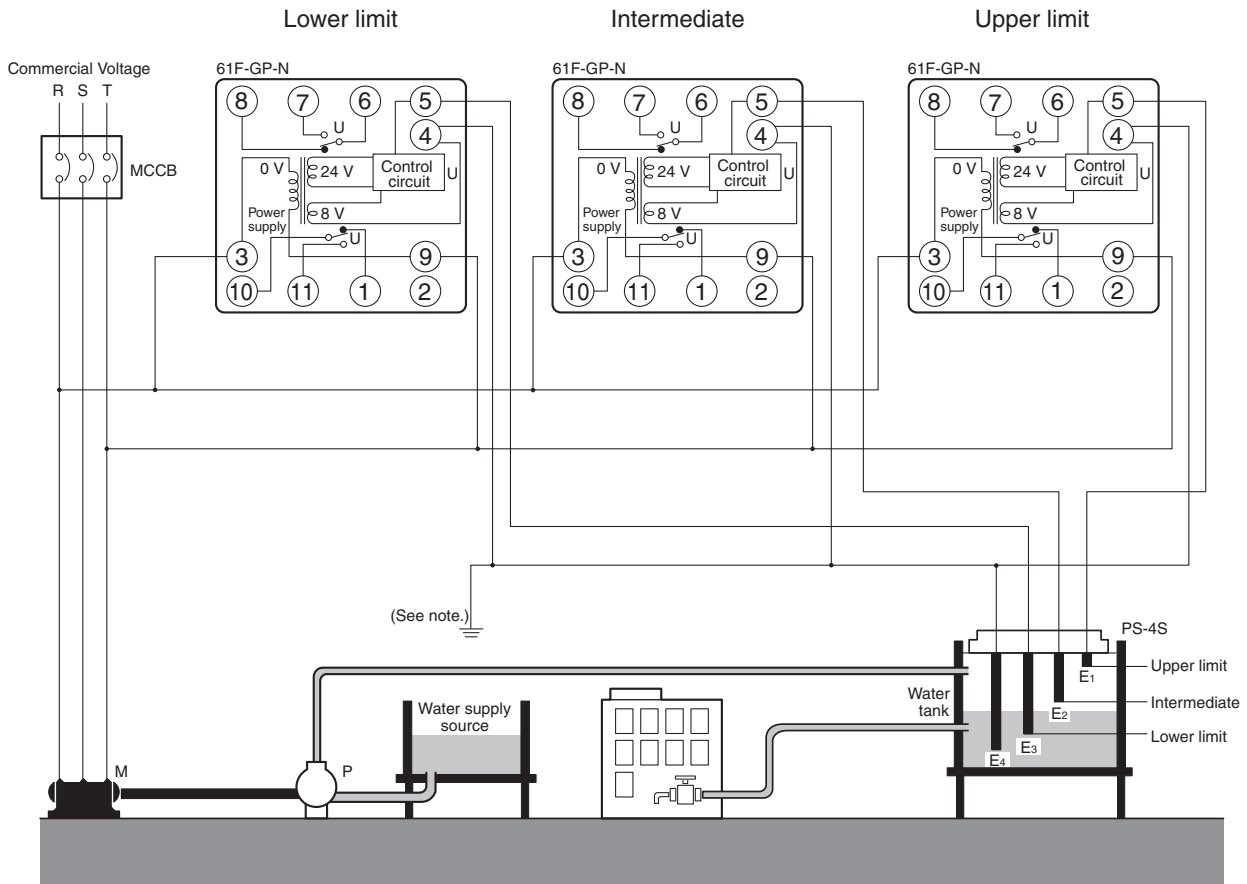

**Note:** The power supply phases (terminals 3 to 9) can be matched to use the same ground for the common Electrode (the longest Electrode, terminal 4).

#### Principles of Operation

- Terminals 6 and 7, and terminals 10 and 11 on the lower -limit 61F-GP-N are shorted when the water level reaches E<sub>3</sub> (indicator ON).
- Terminals 6 and 7, and terminals 10 and 11 on the intermediate 61F-GP-N are shorted when the water level reaches E<sub>2</sub> (indicator ON).
- Terminals 6 and 7, and terminals 10 and 11 on the upper-limit 61F-GP-N are shorted when the water level reaches E<sub>1</sub> (indicator ON).

## Replacing 61F-G3N Functions (Automatic Water Supply Control with Abnormal Water Increase and Water Shortage Alarms)

Compact, Plug-in Type  
61F-GP-N

Dimensions:  
page 14



### Replacing 61F-G3N Functions

#### Connections

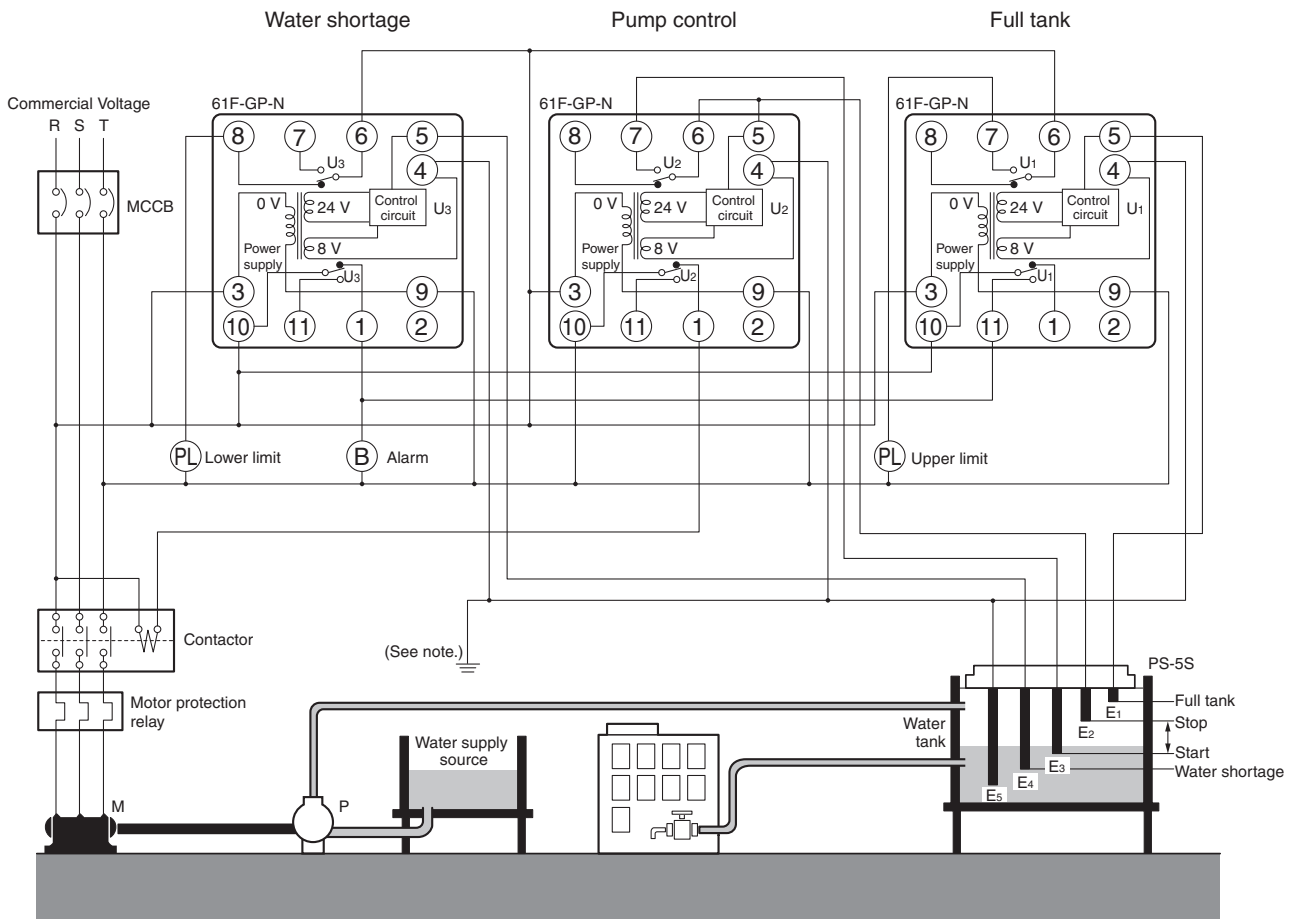

**Note:** The power supply phases (terminals 3 to 9) can be matched to use the same ground for the common Electrode (the longest Electrode, terminal 4).

#### Principles of Operation

- The pump stops when the water level reaches E<sub>2</sub> (U<sub>2</sub> indicator ON) and starts when the water level drops below E<sub>3</sub> (U<sub>2</sub> indicator OFF).
- If the water level rises to E<sub>1</sub> for any reason, the upper-limit indicator turns ON and the alarm sounds (U<sub>1</sub> indicator ON). If the water level drops below E<sub>4</sub> for any reason, the lower-limit indicator turns ON and the alarm sounds (U<sub>3</sub> indicator OFF).

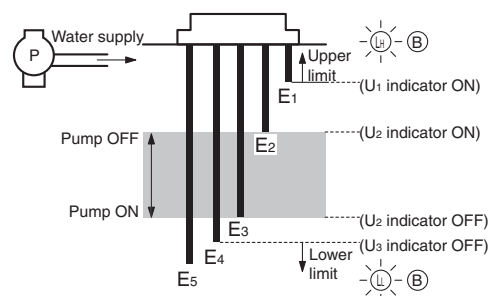

**Two-Wire Connections  
Automatic Water Supply and Drainage Control**

**Compact, Plug-in Type  
61F-GP-NR**

**Dimensions:  
page 14**



Automatic Water Supply Control	Automatic Drainage Control
<p><b>Connections</b></p> <p><b>Note:</b> Be sure to ground the common Electrode E<sub>3</sub> (the longest Electrode).</p> <p><b>Connection Sockets</b> PF113 (Front-connecting) PL11 (Rear-connecting)</p> <ul style="list-style-type: none"> <li>• Connect terminal 1 to the contactor's coil terminal.</li> </ul> <p><b>Note:</b> The power supply depends on the specifications of the model.</p> <ul style="list-style-type: none"> <li>• With 2-wire connections, only two wires are required between the 61F-GP-NR and Electrode Holder, but three wires are required for the Electrodes.</li> <li>• The Electrode Holder must be specified for 2-wire connections. (Resistance R is built into Electrode Holders for 2-Wire Connections.)</li> </ul>	<p><b>Connections</b></p> <p><b>Note:</b> Be sure to ground the common Electrode E<sub>3</sub> (the longest Electrode).</p> <p><b>Connection Sockets</b> PF113 (Front-connecting) PL11 (Rear-connecting)</p> <ul style="list-style-type: none"> <li>• Connect terminal 11 to the contactor's coil terminal.</li> </ul> <p><b>Note:</b> The power supply depends on the specifications of the model.</p> <ul style="list-style-type: none"> <li>• With 2-wire connections, only two wires are required between the 61F-GP-NR and Electrode Holder, but three wires are required for the Electrodes.</li> <li>• The Electrode Holder must be specified for 2-wire connections. (Resistance R is built into Electrode Holders for 2-Wire Connections.)</li> </ul>
<p><b>Principles of Operation</b></p> <p>The pump stops when the water level reaches E<sub>1</sub> (indicator ON) and starts when the water level drops below E<sub>2</sub> (indicator OFF).</p>	<p><b>Principles of Operation</b></p> <p>The pump starts when the water level reaches E<sub>1</sub> (indicator ON) and stops when the water level drops below E<sub>2</sub> (indicator OFF).</p>

## ■ Connection with Three-phase Four-line Circuit

When supplying power from N-phase to the Controller in three-phase four-line circuit, refer to the following diagrams.

Line voltage (R-S, S-T, or R-T): 380 or 415 VAC

Phase voltage (N-R, N-S, or N-T): 220 or 240 VAC

### 61F-GP-N□ 220 or 240 VAC

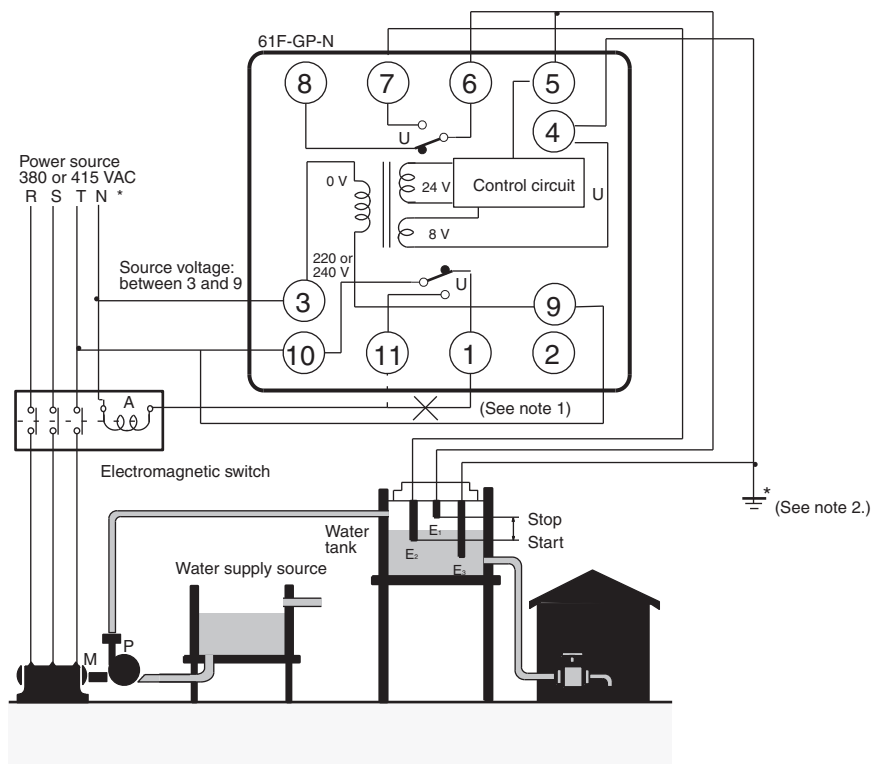

- Note: 1.** The diagram shows the connections for the water supply. When draining, change the connection from terminal 1 to terminal 11.  
**Note: 2.** Be sure to ground terminal 4.



## ■ Compact Plug-in Models (8-pin Type)

### Specifications

Item	General-purpose Controller 61F-GP-N8 61F-GP-N8Y (see note 4)	Long-distance Controllers 61F-GP-N8L 2KM (for 2 km) 61F-GP-N8L 4KM (for 4 km)	High-sensitivity Controllers 61F-GP-N8H 61F-GP-N8HY (see note 4)	Low-sensitivity Controller 61F-GP-N8D	Two-wire Controller 61F-GP-N8R	Variable Sensitivity Controller 61F-GP-N8-V50
<b>Controlling materials and operating conditions</b>	For control of ordinary purified water or sewage water	For control of ordinary purified water in cases where the distance between sewage pumps and water tanks or between receiver tanks and supply tanks is long or where remote control is required.	For control of liquids with high specific resistance such as distilled water	For control of liquids with low specific resistance such as salt water, sewage water, acid chemicals, alkali chemicals	For control of ordinary purified water or sewage water used in combination with Two-wire Electrode Holder (incorporating a resistor of 6.8 kΩ)	For control of cases where variable sensitivity control is required such as detection of froth on the surface of a liquid, control of soil moisture content, or detection of degree of water pollution
<b>Supply voltage</b>	24, 100, 110, 120, 200, 220, 230 or 240 VAC; 50/60 Hz					24, 110, 220 or 240 VAC; 50/60 Hz
<b>Operating voltage range</b>	85% to 110% of rated voltage					
<b>Interelectrode voltage</b>	8 VAC		24 VAC	8 VAC		24 VAC
<b>Interelectrode current</b>	Approx. 1 mA AC max.		Approx. 0.4 mA AC max.	Approx. 1 mA AC max.		Approx. 3 mA AC max.
<b>Power consumption</b>	Approx. 3.5 VA max.					
<b>Interelectrode operate resistance</b>	0 to approx. 4 kΩ	0 to 1.3 kΩ (for 2 km) 0 to 0.5 kΩ (for 4 km)	Approx. 15 kΩ to approx. 70 kΩ (see note 3)	0 to approx. 1.3 kΩ	0 to approx. 2 kΩ	0 to 50 kΩ (Variable)
<b>Interelectrode release resistance</b>	Approx. 15 k to ∞ Ω	4 k to ∞ Ω (for 2 km) 2.5 k to ∞ Ω (for 4 km)	Approx. 300 k to ∞ Ω	Approx. 4 k to ∞ Ω	Approx. 15 k to ∞ Ω	Operating resistance +50 kΩ max.
<b>Response time</b>	Operate: 80 ms max. Release: 160 ms max.					
<b>Cable length (see note 1)</b>	1 km max.	2 km max. 4 km max.	50 m max.	1 km max.	800 m max.	50 m max.
<b>Control output</b>	1 A, 250 VAC (Inductive load: $\cos\phi = 0.4$ ) 3 A, 250 VAC (Resistive load)					
<b>Ambient temperature</b>	Operating: -10 to 55°C					
<b>Ambient humidity</b>	Operating: 45% to 85% RH					
<b>Insulation resistance (see note 2)</b>	100 MΩ min. (at 500 VDC)					
<b>Dielectric strength (see note 2)</b>	2000 VAC, 50/60 Hz for 1 min.					
<b>Life expectancy</b>	Electrical: 100,000 operations min. Mechanical: 5,000,000 operations min.					
<b>Weight</b>	Approx. 155 g					
<b>Accessories</b>	Hold-down clip PFC-N8					
<b>Approved standards</b>	UL508, CSA C22.2 No.14, EN61010-1, EN61326-1 Industrial electromagnetic environment					

**Note: 1.** The length when using completely-insulated, 600-V, 3-conductor (0.75 mm<sup>2</sup>) cable cables. Usable cable lengths will become shorter as the cable diameter or number of conductors becomes larger.

**2.** The insulation resistance and dielectric strength indicate values between power terminals and Electrode terminals, between power terminals and contact terminals, and between Electrode terminals and contact terminals.

**3.** Possible to use with 15 kΩ or less, however, this may cause reset failure.

**4.** 61F-GP-N8H/-N8Y High-sensitivity Controllers use advanced operation.

When the power supply voltage is applied, if there are some liquids between the electrodes (ground and operation electrodes), the internal relay will not operate.

When the power supply voltage is applied, if there are no liquids between the electrodes (ground and operation electrodes), the internal relay will operate.

If the advanced operation does not satisfy applications, consider using 61F-N8HY controller which uses sequential operation.

## Internal Circuit Diagrams

**61F-GP-N8/-N8L/-N8D/-N8HY**

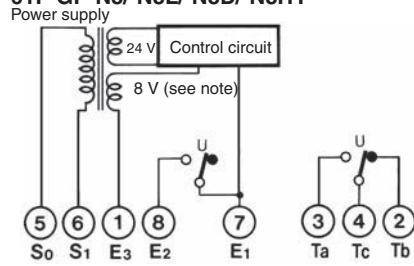

**61F-GP-N8H**

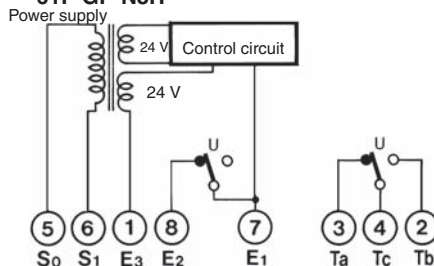

**61F-GP-N8R**

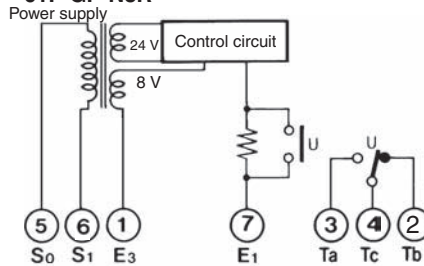

**Note:** 24 V for the 61F-GP-N8HY.

**61F-GP-N8Y**

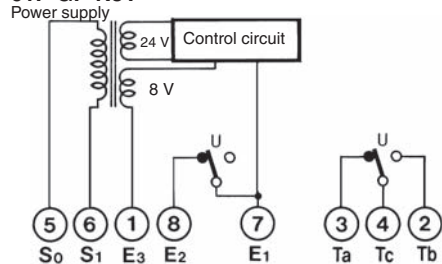

**61F-GP-N8-V50**

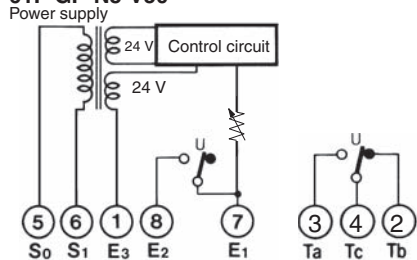

Automatic Water Supply and Drainage Control

Compact, Plug-in Type  
61F-GP-N8

Dimensions:  
page 14



Automatic Water Supply Control	Automatic Drainage Control
<p><b>Connections</b></p> <p><b>Note:</b> Be sure to ground the common Electrode E<sub>3</sub> (the longest Electrode).</p> <p><b>Connection Sockets</b> PF083A (Front-connecting) PL08 (Rear-connecting)</p> <ul style="list-style-type: none"> <li>Connect terminal 2 to the contactor's coil terminal.</li> </ul> <p><b>Note:</b> The power supply depends on the specifications of the model.</p>	<p><b>Connections</b></p> <p><b>Note:</b> Be sure to ground the common Electrode E<sub>3</sub> (the longest Electrode).</p> <p><b>Connection Sockets</b> PF083A (Front-connecting) PL08 (Rear-connecting)</p> <ul style="list-style-type: none"> <li>Connect terminal 3 to the contactor's coil terminal.</li> </ul> <p><b>Note:</b> The power supply depends on the specifications of the model.</p>
<p><b>Principles of Operation</b></p> <p>The pump stops when the water level reaches E<sub>1</sub> (indicator ON) and starts when the water level drops below E<sub>2</sub> (indicator OFF).</p>	<p><b>Principles of Operation</b></p> <p>The pump starts when the water level reaches E<sub>1</sub> (indicator ON) and stops when the water level drops below E<sub>2</sub> (indicator OFF).</p>

**Two-Wire Connections  
Automatic Water Supply and Drainage Control**

**Compact, Plug-in Type  
61F-GP-N8R**

**Dimensions:  
page 14**



Water Supply	Automatic Drainage
<p><b>Connections</b></p> <p><b>Note: Be sure to ground the common Electrode E<sub>3</sub> (the longest Electrode).</b></p> <ul style="list-style-type: none"> <li>• Connect terminal 2 to the contactor's coil terminal.</li> </ul> <p><b>Note:</b> The power supply depends on the specifications of the model.</p> <ul style="list-style-type: none"> <li>• With 2-wire connections, only two wires are required between the 61F-GP-N8R and Electrode Holder, but three wires are required for the Electrodes.</li> <li>• The Electrode Holder must be specified for 2-wire connections. (Resistance R is built into Electrode Holders for 2-Wire Connections.)</li> </ul>	<p><b>Connections</b></p> <p><b>Note: Be sure to ground the common Electrode E<sub>3</sub> (the longest Electrode).</b></p> <ul style="list-style-type: none"> <li>• Connect terminal 3 to the contactor's coil terminal.</li> </ul> <p><b>Note:</b> The power supply depends on the specifications of the model.</p> <ul style="list-style-type: none"> <li>• With 2-wire connections, only two wires are required between the 61F-GP-N8R and Electrode Holder, but three wires are required for the Electrodes.</li> <li>• The Electrode Holder must be specified for 2-wire connections. (Resistance R is built into Electrode Holders for 2-Wire Connections.)</li> </ul>
<p><b>Principles of Operation</b></p> <p>The pump stops when the water level reaches E<sub>1</sub> (indicator ON) and starts when the water level drops below E<sub>2</sub> (indicator OFF).</p>	<p><b>Principles of Operation</b></p> <p>The pump starts when the water level reaches E<sub>1</sub> (indicator ON) and stops when the water level drops below E<sub>2</sub> (indicator OFF).</p>

## ■ Connection with Three-phase Four-line Circuit

When supplying power from N-phase to the Controller in three-phase four-line circuit, refer to the following diagrams.

Line voltage (R-S, S-T, or R-T): 380 or 415 VAC

Phase voltage (N-R, N-S, or N-T): 220 or 240 VAC

### 61F-GP-N8□, 220 or 240 VAC

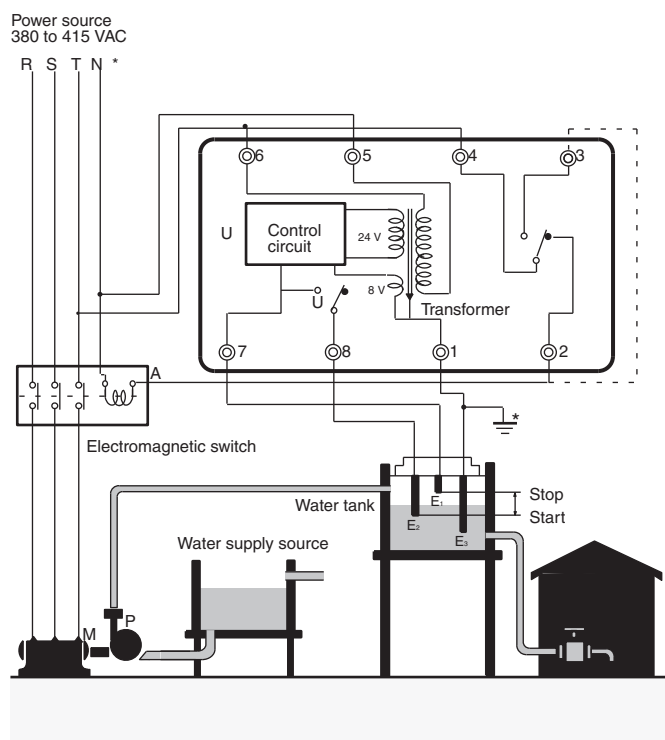

**Note:** Be sure to ground terminal 1.

## Dimensions

**Note:** All units are in millimeters unless otherwise indicated.

### 61F-GP-N, -NT, -NL, -NH, -ND, -NR, -N -TDL, -N14, -N15, -NH3

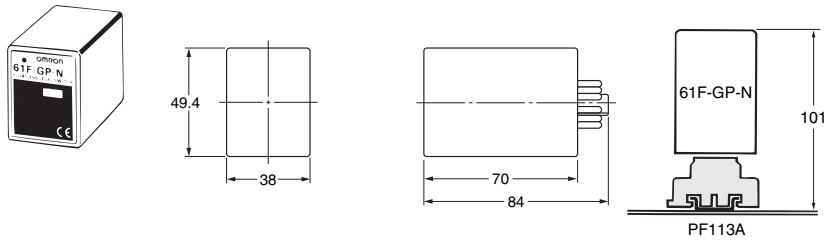

When mounting a Display Unit to a PF113A Surface-mounting Socket, secure the PF113A with the groove facing toward the bottom and then connect the 61F-GP-N the PFC-N8 accessory.

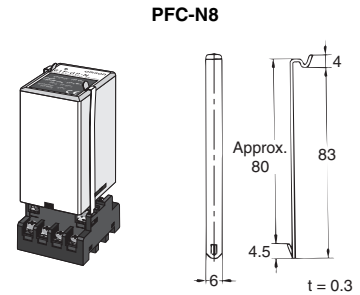

**Note:** PFC-N8 Mounting Bracket (provided with the Level Controller)

### 61F-GP-N8, -N8L, -N8H, -N8HY, -N8D, -N8R

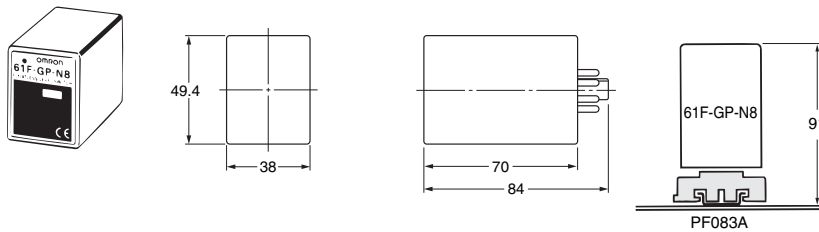

Use a PFC-N8 Mounting Bracket to mount the Level Controller to a PF083A Rail-mounted Socket.

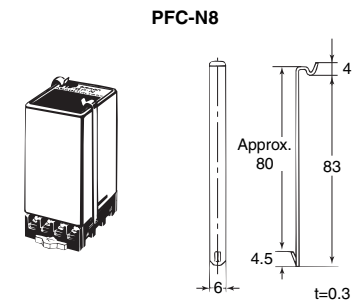

**Note:** PFC-N8 Mounting Bracket (provided with the Level Controller)

## ■ Safety Precautions

Refer to *Safety Precautions for All Level Controllers*.

ALL DIMENSIONS SHOWN ARE IN MILLIMETERS.

To convert millimeters into inches, multiply by 0.03937. To convert grams into ounces, multiply by 0.03527.

In the interest of product improvement, specifications are subject to change without notice.

## Terms and Conditions Agreement

### Read and understand this catalog.

Please read and understand this catalog before purchasing the products. Please consult your OMRON representative if you have any questions or comments.

### Warranties.

(a) Exclusive Warranty. Omron's exclusive warranty is that the Products will be free from defects in materials and workmanship for a period of twelve months from the date of sale by Omron (or such other period expressed in writing by Omron). Omron disclaims all other warranties, express or implied.

(b) Limitations. OMRON MAKES NO WARRANTY OR REPRESENTATION, EXPRESS OR IMPLIED, ABOUT NON-INFRINGEMENT, MERCHANTABILITY OR FITNESS FOR A PARTICULAR PURPOSE OF THE PRODUCTS. BUYER ACKNOWLEDGES THAT IT ALONE HAS DETERMINED THAT THE PRODUCTS WILL SUITABLY MEET THE REQUIREMENTS OF THEIR INTENDED USE.

Omron further disclaims all warranties and responsibility of any type for claims or expenses based on infringement by the Products or otherwise of any intellectual property right. (c) Buyer Remedy. Omron's sole obligation hereunder shall be, at Omron's election, to (i) replace (in the form originally shipped with Buyer responsible for labor charges for removal or replacement thereof) the non-complying Product, (ii) repair the non-complying Product, or (iii) repay or credit Buyer an amount equal to the purchase price of the non-complying Product; provided that in no event shall Omron be responsible for warranty, repair, indemnity or any other claims or expenses regarding the Products unless Omron's analysis confirms that the Products were properly handled, stored, installed and maintained and not subject to contamination, abuse, misuse or inappropriate modification. Return of any Products by Buyer must be approved in writing by Omron before shipment. Omron Companies shall not be liable for the suitability or unsuitability or the results from the use of Products in combination with any electrical or electronic components, circuits, system assemblies or any other materials or substances or environments. Any advice, recommendations or information given orally or in writing, are not to be construed as an amendment or addition to the above warranty.

See <http://www.omron.com/global/> or contact your Omron representative for published information.

### Limitation on Liability: Etc.

OMRON COMPANIES SHALL NOT BE LIABLE FOR SPECIAL, INDIRECT, INCIDENTAL, OR CONSEQUENTIAL DAMAGES, LOSS OF PROFITS OR PRODUCTION OR COMMERCIAL LOSS IN ANY WAY CONNECTED WITH THE PRODUCTS, WHETHER SUCH CLAIM IS BASED IN CONTRACT, WARRANTY, NEGLIGENCE OR STRICT LIABILITY.

Further, in no event shall liability of Omron Companies exceed the individual price of the Product on which liability is asserted.

### Suitability of Use.

Omron Companies shall not be responsible for conformity with any standards, codes or regulations which apply to the combination of the Product in the Buyer's application or use of the Product. At Buyer's request, Omron will provide applicable third party certification documents identifying ratings and limitations of use which apply to the Product. This information by itself is not sufficient for a complete determination of the suitability of the Product in combination with the end product, machine, system, or other application or use. Buyer shall be solely responsible for determining appropriateness of the particular Product with respect to Buyer's application, product or system. Buyer shall take application responsibility in all cases.

NEVER USE THE PRODUCT FOR AN APPLICATION INVOLVING SERIOUS RISK TO LIFE OR PROPERTY OR IN LARGE QUANTITIES WITHOUT ENSURING THAT THE SYSTEM AS A WHOLE HAS BEEN DESIGNED TO ADDRESS THE RISKS, AND THAT THE OMRON PRODUCT(S) IS PROPERLY RATED AND INSTALLED FOR THE INTENDED USE WITHIN THE OVERALL EQUIPMENT OR SYSTEM.

### Programmable Products.

Omron Companies shall not be responsible for the user's programming of a programmable Product, or any consequence thereof.

### Performance Data.

Data presented in Omron Company websites, catalogs and other materials is provided as a guide for the user in determining suitability and does not constitute a warranty. It may represent the result of Omron's test conditions, and the user must correlate it to actual application requirements. Actual performance is subject to the Omron's Warranty and Limitations of Liability.

### Change in Specifications.

Product specifications and accessories may be changed at any time based on improvements and other reasons. It is our practice to change part numbers when published ratings or features are changed, or when significant construction changes are made. However, some specifications of the Product may be changed without any notice. When in doubt, special part numbers may be assigned to fix or establish key specifications for your application. Please consult with your Omron's representative at any time to confirm actual specifications of purchased Product.

### Errors and Omissions.

Information presented by Omron Companies has been checked and is believed to be accurate; however, no responsibility is assumed for clerical, typographical or proofreading errors or omissions.

2018.12

In the interest of product improvement, specifications are subject to change without notice.

**OMRON Corporation**  
Industrial Automation Company

<http://www.ia.omron.com/>

(c)Copyright OMRON Corporation 2018 All Right Reserved.