

CATALOGUE 2020

INDUSTRIAL PLUGS AND SOCKETS

UK

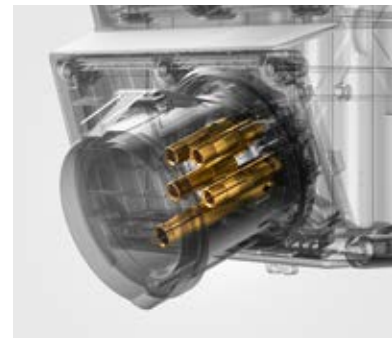



„In international markets we gain the confidence of customers with close proximity, excellent service and flexibility coupled with solution based advise.“

Andrea Garte, Director International Sales



„Internationalisation is vital for MENNEKES. We offer worldwide solutions to our partners and customers on a day to day basis. Gaining new customers is just as important as retaining our existing ones.“

Miriam Richard, Area Sales Manager Latin America & Iberian Peninsula



„As a reliable partner to our customers, we promote openness, honesty and trust based on mutual respect. Our aim is that customers are more than satisfied with our brand. Innovative products and individual service are the basis of long term partnerships.“

Arda Tünay, Area Sales Manager Middle East & Africa



„High quality combined with global presence and local competence are the pillars and foundation of the MENNEKES brand.“

Jörg Schneider, Sales Manager Asia-Pacific

 **MENNEKES**
MY POWER CONNECTION

We like to communicate with you. Do you have special requests and requirements? Talk to us, we like to give you advice and will provide individual solutions for you.

Content

	Page
1 About us	
The company	4 - 7
Contact persons at MENNEKES in UK	8 - 9
2 Sockets	
Wall mounted sockets	13 - 15
Wall mounted sockets switched and interlocked or fused	16 - 21
Sockets Cepex	22
Panel mounted sockets	23 - 26
Panel mounted sockets, switched and interlocked	27
3 Plugs and connectors	
Plugs	31 - 32
Wall mounted inlets	33
Panel mounted inlets	34
Phase sequence test plugs	35
Phase inverter plugs	36
Wall and panel mounted phase inverter inlets	37
Connectors	38 - 39
4 Combination units	
AMAXX®, wall mounted, IP 44	45 - 47
AMAXX®, wall mounted, IP 67	48 - 49
Accessories for AMAXX®	50
High resistance to chemicals, made of AMELAN	51
AMAXX®, suspended, IP 44	52 - 53
3KRAFT and AirKRAFT, DELTA-BOXES, Socket strips	55 - 57
EverGUM, Mobile distributors	59 - 61
Steel and stainless steel	63 - 65
5 Special plugs and sockets	
SCHUKO® and grounding-type	67 - 69
7 pole	71 - 72
For low voltage	73 - 75
200 A up to 400 A	77 - 78
Energy and data	79 - 83
For reefer containers	85 - 87
TM for military purpose	88 - 89
Camping	90
Switch disconnectors	91
6 Service	
References	92 - 93
Regulations and standards	94 - 101
Drawings and Dimensions	102 - 115
Index of part numbers	116 - 119

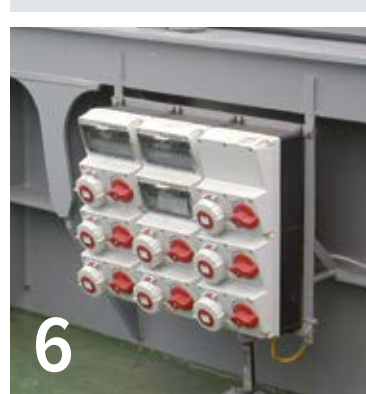

1

2

3

4

5

6



„I am proud to be able to continue this tradition in the third generation.“

Christopher Menekes, General Management Director

MENNEKES – The company.

When my grandfather, Aloys Mennekes, received his Master Electrician's certificate in 1935, he surely was not aware of what would develop from his commitment to electrical engineering. At that time, he knew only one thing: he wanted to put his ideas into practice and manufacture his own products.

As you leaf through the pages of this catalogue, you get a feeling of how strongly this initial entrepreneurial desire continues to design us today. The variety of the products on display clearly shows that we still have great pleasure in converting our ideas into new products. But marketable ideas are rarely generated behind closed doors. As specialists, we therefore develop individual solutions together with our customers. Hence our product portfolio today consists of more than 10,000 customised products, far more than we can show in this catalogue.

Since it was founded over 80 years ago, MENNEKES has been a wholly owned family business, responsibly managed by members of the owner family throughout. Responsibility for the Company also means responsibility for the people who are at the heart of our thinking and actions at MENNEKES. Through their awareness of the values of diligence, reliability and loyalty, they constitute an important cornerstone of the Company.

I am proud to be able to continue this tradition in the third generation.

These are fascinating times for the preservation of tradition because, due to the digital revolution, many things are going to change in the next decade. In this world flooded with information, MENNEKES wants to be a point of reference on which our customers can rely for quality, safety and functionality. We say with confidence: Our brand is a promise.

Thank you for believing this promise and thus supporting our business philosophy.

Christopher Mennekes
General Management Director



Aloys Mennekes (center) with apprentice and journeyman on their way to work



Plugs and sockets for toughest conditions



Family Mennekes (from left): Petra and Walter, Daniela and Christopher and Michael and Steffen

1 Quality – Tested under extreme conditions.



When a MENNEKES product leaves our factory, it has already survived the harshest testing. In our test lab it is exposed to cold, heat, dust and water over and over again. Only the products that withstand these tests are worthy of the name MENNEKES. Our products are of course certified to national and international standards by recognised institutions. Like the MENNEKES company itself. Our international quality management system is certified to DIN EN ISO 9001.

Independent test organizations certify that our products offer the highest levels of safety, quality and trouble free use.

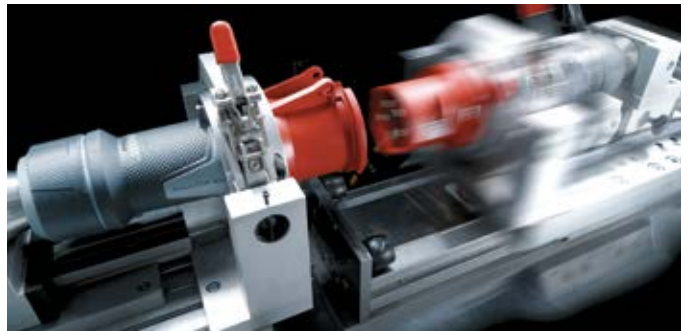
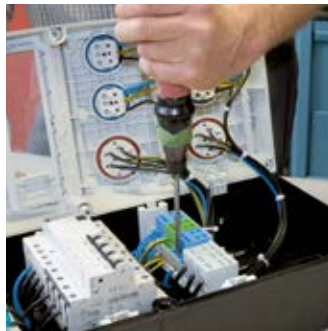

ZERTIFIKAT  **MENNEKES**
MY POWER CONNECTION

CERTIFICATE

für stückgeprüfte Qualität nach DIN EN 61439.

for individually tested quality according to IEC 61439.

Hiermit bestätigen wir, dass diese Steckdosen-Kombination einer Stückprüfung unterzogen wurde.
Hereby we confirm that this receptacle combination has passed a random test.

Der MENNEKES-Sicherheitsstempel berücksichtigt nicht nur die elektrischen Prüfbedingungen nach DIN EN 61439, sondern beinhaltet darüber hinaus auch eine allgöige Hochspannungsprüfung.
The MENNEKES safety test not just include the requirements for electrical tests acc. to IEC 61439 but also a high voltage test for all poles.

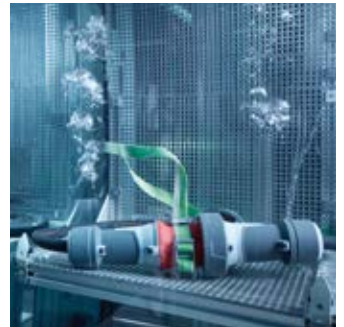

Only the combination of first-class raw materials and advanced manufacturing processes guarantee a premium product. This is why we use only first-grade plastics which are processed by a highly skilled workforce in state-of-the-art production facilities to create certified MENNEKES products.

We guarantee the high quality standard of our products by our own test laboratory. This laboratory is approved and will be used for product tests of our products to get test marks acc. to DIN EN 60309 by approval authorities like the VDE etc.

Regionally rooted – At home around the world.

Everywhere, close to the customer: Our domestic market, Germany, is supported from our corporate headquarters in Kirchhundem, as well as by sales agencies and our own field service team. With our subsidiaries and sales offices, we are represented by our own employees in the most important international growth markets.

You must be able to rely on MENNEKES. This is and remains the motivation of our 1,200 employees worldwide. It is they who, through their efforts on a daily basis, demonstrate the commitment to the MENNEKES brand.

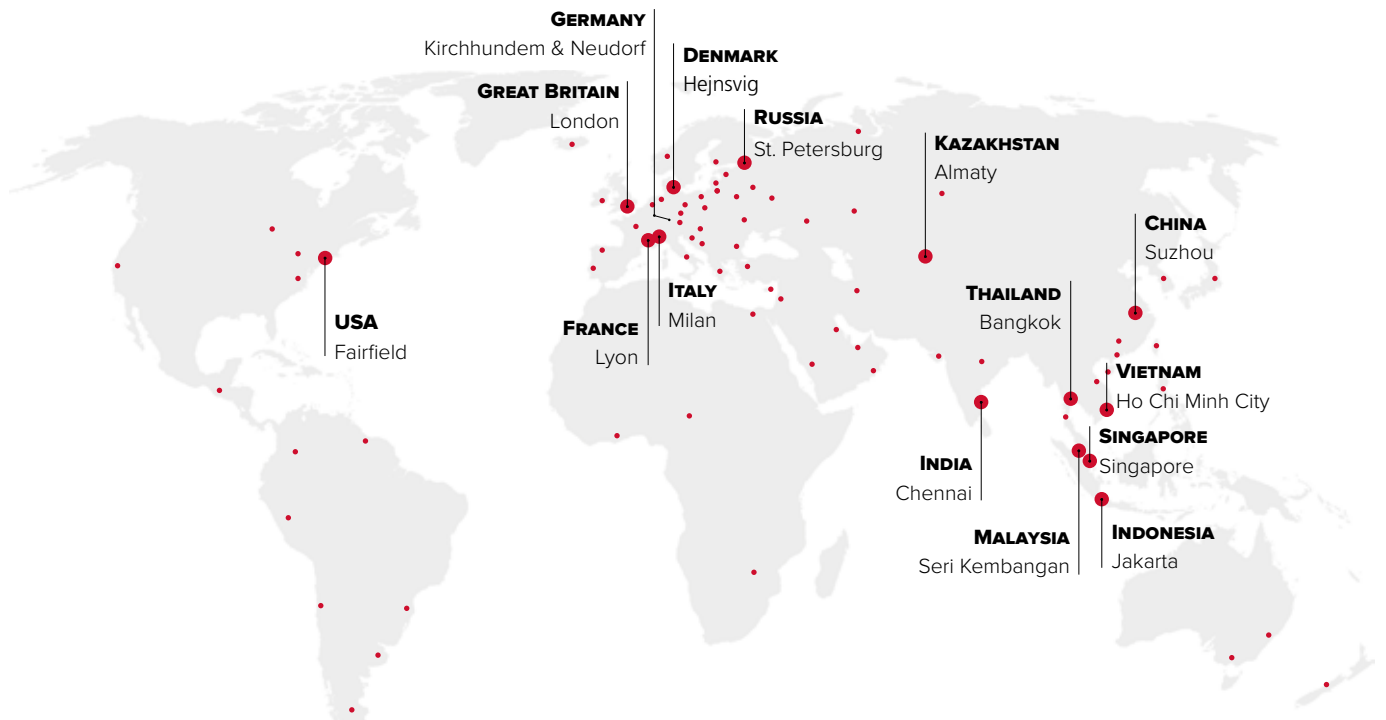

Subsidiaries:

- Great Britain
- USA
- China
- Singapore
- Italy
- France
- Russia
- India

Representative Offices:

- Thailand
- Indonesia
- Malaysia
- Kazakhstan
- Denmark
- Vietnam

Commercial agencies:

- 15 in Germany
- 29 in Europe
- 46 outside of Europe

1 About us – Contact persons at MENNEKES in UK.

MENNEKES Electric Ltd.



Unit 4, Crayfields Industrial Park
Main Road, St. Pauls Cray
Orpington, KENT BR5 3HP, UK
Phone 0 16 89 83 35 22
Fax 0 16 89 83 33 78
sales@MENNEKES.co.uk

Management Team



Chris Stockdale
Managing Director
Phone 01689 881600
Fax 01689 833378
christopher.stockdale@
MENNEKES.co.uk



Alan Beardsley
Works Manager
Phone 01689 833522
Fax 01689 833378
alan.beardsley@MENNEKES.co.uk

Sales Office Team



Wendy Sargent
Accounts Department
Phone 01689 881607
Fax 01689 881601
wendy.sargent@MENNEKES.co.uk



Roy Choules
Internal Sales
Phone 01689 833522
Fax 01689 833378
roy.choules@MENNEKES.co.uk



Russell Massey
Internal Sales
Phone 01689 833522
Fax 01689 833378
russell.massey@MENNEKES.co.uk

Regional Sales Engineers

01 - North & Scotland

Gordon Brownlie
Phone +44 1689 83 35 22
Mobile +44 7950 39 40 15
Fax +44 1689 83 33 78
gordon.brownlie@mennekes.co.uk

02 - Central

Paul O'Brien
Phone +44 1689 83 35 22
Mobile +44 7793 220931
Fax +44 1689 833 378
paul.obrien@mennekes.co.uk

03 - Midlands

Ian Whitby-Smith
Phone +44 1689 833522
Mobile +44 7711 054819
Fax +44 1689 833378
ian.whitby-smith@mennekes.co.uk

04 - South East

Andy Duddy
Phone +44 1689 833 522
Mobile +44 7704 156581
Fax +44 1689 833 378
andy.duddy@mennekes.co.uk

05 - South West

Paul Brocklebank
Phone +44 1689 83 35 22
Mobile +44 7985 260180
Fax +44 1689 83 33 78
paul.brocklebank@mennekes.co.uk

About us – Regional Sales Areas.

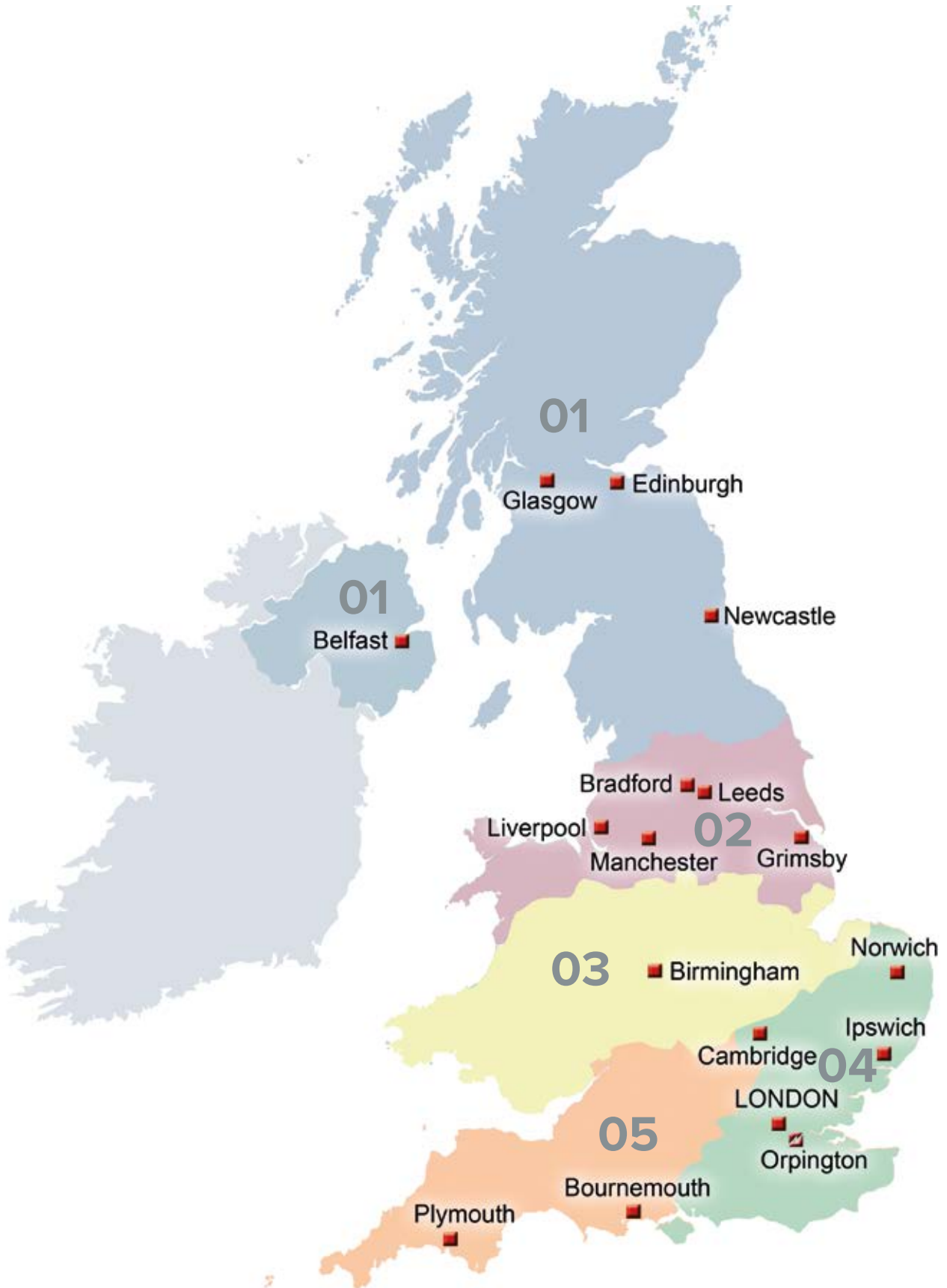

X-CONTACT

The future is now.

The new generation of contact sleeves.

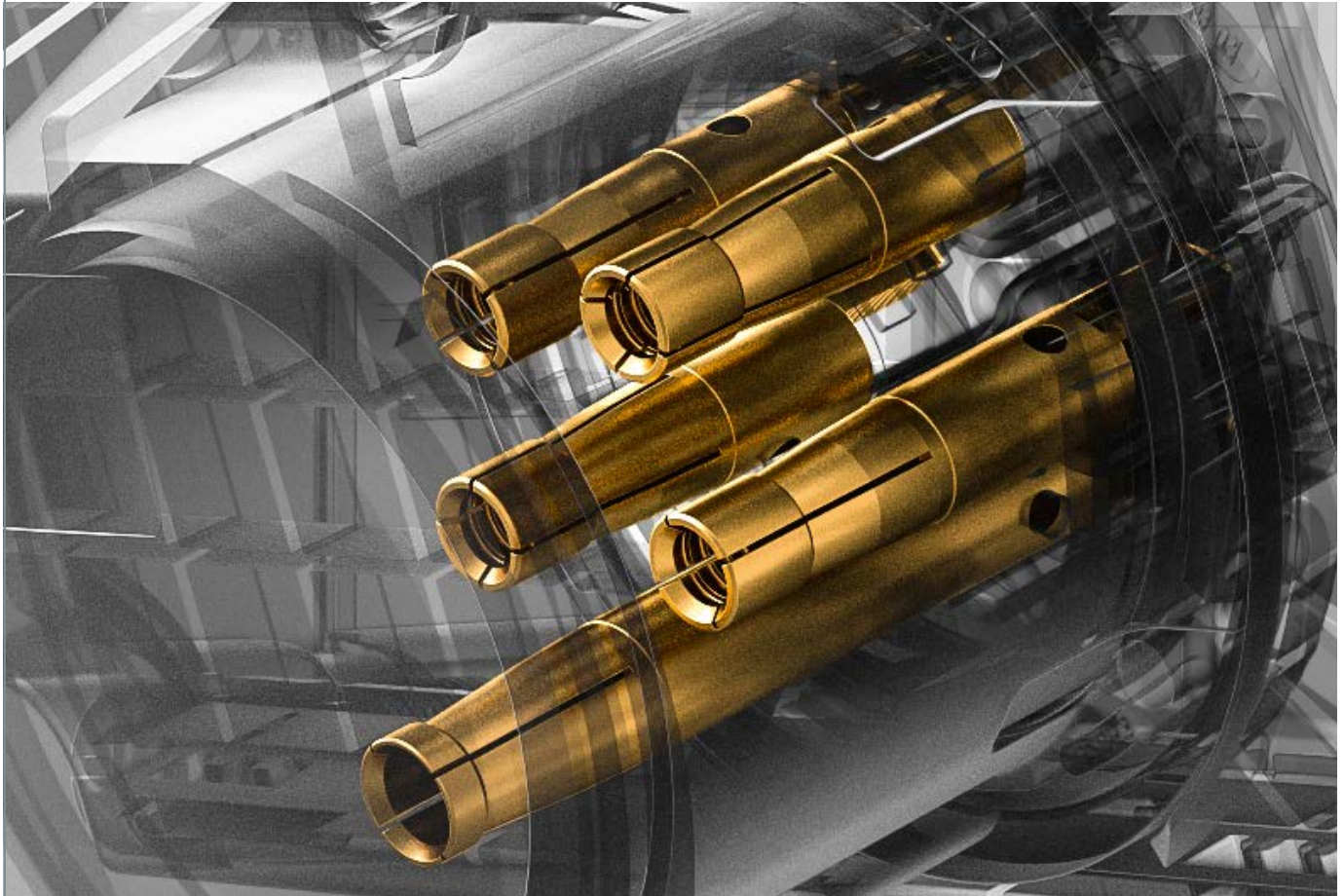

As a specialist for plugs and sockets MENNEKES is known worldwide for setting standards. In the past few years, we dealt intensively with current requirements of the electric mobility and automotive sectors. We used the know-how gained to develop a completely new contact sleeve solution for industrial connectors and sockets: X-CONTACT

More contact

It is important to achieve the best possible balance between a safe contact closure and ease of insertion. We have successfully implemented this with X-CONTACT in an entirely new way

Due to a completely new manufacturing process, the X-CONTACT sleeve has resilient properties based solely on its material characteristics, without the need to use any additional spring elements. Thanks to the shape of the X-CONTACT sleeve, a particularly safe contact closure can be achieved.

Less effort

The special design of the X-CONTACT reduces the effort of insertion and withdrawal by up to 50 %. An advantage that simplifies work processes and improves safety especially with high electrical currents. With X-CONTACT, MENNEKES creates a safe contact closure and easy handling at a new, equally high level.

But how does X-CONTACT achieve these benefits even with currents of 63 A or 125 A? A glance into the opening of an X-CONTACT sleeve reveals the intelligent functional principle: the X-shaped slot and groove in the inner wall provides four advantages of the new design: innovative, simple, durable and safe. We call it the X principle.

In all 63 A and 125 A wall mounted and panel mounted sockets.



Innovative

Due to the slotted sleeves with their resilient material properties, X-CONTACT is the simplest possible mechanical solution: the plug pin simply expands the opening of the resilient contact sleeve, which reduces the force needed to connect and disconnect the plug by up to 50 %.

X-CONTACT – intelligently innovative!

Durable

Even in cases when the plug is connected and disconnected frequently, there are no signs of wear and the sleeve material remains fatigue-proof in the long term even after rough handling. Due to the quality of the new sleeves, contamination and surface corrosion is automatically removed by connecting and disconnecting.

X-CONTACT – lasting solution!

Simple

In practice, X-CONTACT simplifies work processes. The connection is easier to handle when compared to conventional contact sleeves.

X-CONTACT – simply brilliant!

Safe

A higher degree of safety of handling is provided by the easier connection and disconnection. The groove within the inner wall in connection with the resilient material of the contact sleeves provides for a safe contact closure.

X-CONTACT – double safety!



Get more information on the new generation of contact sleeves at:
www.mennekes.org/x-contact



TwinCONTACT

The swift connection.

Looking for quick and easy connection?

You can't miss the MENNEKES TwinCONTACT – a spring terminal in a newly designed socket. Remove the insulation, insert the conductors, and you're done. The contact is safely in place and it is even approved as a connection terminal – undo the conductor, that's all it takes. Press the red button and remove the conductor – this is our concept of convenient and time-saving handling.

2

Colour-coded terminals for unmistakable connections.



Suitable for solid conductors and flexible conductors (with end sleeve for strands, crimped so as to be gas-tight or ultrasonically welded).

Cond. cross section:
at 16 A: 1.5 - 4.0 mm²
at 32 A: 2.5 - 10.0 mm²



Video:
mounting
instructions

Sockets with screw terminals.





Removable cover for easy access to wiring space.



All contact screws face the same way. Open terminals. Terminals visible through slits.

Sockets – Wall mounted, with screw terminals

to DIN VDE 0623, EN 60309-2.  Highly resistant to chemicals. Other voltages and frequencies available on request. For drawings and dimensions see page 102 - 110. Products with pilot contact available on request.



Wall mounted socket
external fixing

IP 44
Std. Pack. Qty: 10
Drawing: 1 MB 463

A	P	110 V 50 a. 60 Hz	230 V 50 a. 60 Hz	400 V 50 a. 60 Hz	500 V 50 a. 60 Hz	>50 - 500 V 100-300 Hz 300-500 Hz	
16	3		27001				
16	4			27002	27003		
16	5			27004			
32	3		27005				
32	4			27006	27007		
32	5			27008			



Wall mounted socket
internal fixing, 4 p and 5 p sockets
the enclosure can be turned 180°

IP 44
Std. Pack. Qty: 10
Drawing: 1 MB 209

A	P	110 V 50 a. 60 Hz	230 V 50 a. 60 Hz	400 V 50 a. 60 Hz	500 V 50 a. 60 Hz	>50 - 500 V 100-300 Hz 300-500 Hz	
16	3	100	101	102		2169	2241
16	4	103	104	105	106	107	108
16	5	109	110	111	2000	2188	2199



Wall mounted socket
internal fixing, enclosure base can be
turned 180°, sockets are designed for
adding an auxiliary contact switch

IP 44
Std. Pack. Qty: 10
Drawing: 1 MB 43

A	P	110 V 50 a. 60 Hz	230 V 50 a. 60 Hz	400 V 50 a. 60 Hz	500 V 50 a. 60 Hz	>50 - 500 V 100-300 Hz 300-500 Hz	
16	4	3030	3034	1418	3032	3035	3028
16	5	3141	3045	1419	3043	3046	3039
32	3	1420	1421	1422		3139	3134
32	4	1423	1424	1425	1426	1427	1428
32	5	1555	1556	1557	3152	3154	3149



Wall mounted socket
X-CONTACT®, suitable for through
wiring, internal fixing, enclosure
base can be turned 180°

IP 44
Std. Pack. Qty: 5
Drawing: 1 MB 213

A	P	110 V 50 a. 60 Hz	230 V 50 a. 60 Hz	400 V 50 a. 60 Hz	500 V 50 a. 60 Hz	>50 - 500 V 100-300 Hz 300-500 Hz	
63	3	1136A	1137A				
63	4		1140A	1141A	1142A		
63	5		1144A	1145A			



Wall mounted socket
highly resistant to chemicals, with
2 external fixing points, enclosure
base can be turned 180°, sockets
are designed for adding an auxiliary
contact switch

IP 67
Std. Pack. Qty: 10
Drawing: 1 MB 622

A	P	110 V 50 a. 60 Hz	230 V 50 a. 60 Hz	400 V 50 a. 60 Hz	500 V 50 a. 60 Hz	>50 - 500 V 100-300 Hz 300-500 Hz	
16	3	9300	9301	9302			
16	4	9320	9321	9322	9323	9325	
16	5	9340	9341	9342			
32	3	9350	9351	9352			
32	4	9370	9371	9372	9373	9374	
32	5	9380	9381	9382			



Wall mounted socket
X-CONTACT, internal fixing,
enclosure base can be turned 180°,
with 6 fixing points to accommodate
special terminals

IP 67
Std. Pack. Qty: 5
Drawing: 1 MB 112

A	P	110 V 50 a. 60 Hz	230 V 50 a. 60 Hz	400 V 50 a. 60 Hz	500 V 50 a. 60 Hz	>50 - 500 V 100-300 Hz 300-500 Hz	
63	3	856	128A	129A			
63	4	130A	131A	132A	133A		
63	5	134A	135A	136A	2007A		

Sockets – Wall mounted, with screw terminals

Selon DIN VDE 0623, EN 60309-2. Autres tensions et fréquences sur demande. Consulter les schémas et les dimensions pages 108-115.



Wall mounted socket
X-CONTACT, highly resistant to chemicals, highly heat resistant contact carrier, nickel plated contacts

IP 67
Std. Pack. Qty: 5
Drawing: 1 MB 112

A	P	110 V 50 a. 60 Hz	230 V 50 a. 60 Hz	400 V 50 a. 60 Hz	500 V 50 a. 60 Hz	>50 - 500 V	
		100-300 Hz	300-500 Hz				
63	4			3773			
63	5			3774			

2



Wall mounted socket
X-CONTACT

IP 67
Std. Pack. Qty: 3
Drawing: 1 MB 162

A	P	110 V 50 a. 60 Hz	230 V 50 a. 60 Hz	400 V 50 a. 60 Hz	500 V 50 a. 60 Hz	>50 - 500 V	
		100-300 Hz	300-500 Hz				
125	4	137	138	139	140		
125	5	141	142	143	2139		

High resistance to chemicals High quality plastics.

For use in industrial premises or place of work where the use of chemicals or other aggressive substances makes it necessary to use other plastic materials, MENNEKES offers products with increased stability against fuel, oil and grease, diluted acids and alkali, cleaner and the most aqueous salt solutions. These products are marked in the catalogue with . Products made of AMELAN (grey RAL 7000 or electric grey RAL 7035) combine high mechanical, thermal and electrical properties with excellent dimensional stability and resistance to chemicals and are fit for action in chemical plants, in refineries, in the food processing industry, in washdown areas and so on





High resistance to:

- sea water
- detergents
- edible fat
- aqueous soap solution
- natronloog
- motor oils
- milk
- caustic potash
- fruit juices
- diesel oil
- gasoline
- aqueous ammonia solution



Sockets – Wall mounted, screwless, with TwinCONTACT

to DIN VDE 0623, EN 60309-2.  Highly resistant to chemicals. Other voltages and frequencies available on request. For drawings and dimensions see page 102 - 110. Products with pilot contact available on request.



Wall mounted socket
screwless, with TwinCONTACT,
external fixing

IP 44
Std. Pack. Qty: 10
Drawing: 1 MB 463

A	P	110 V	230 V	400 V	500 V	>50 - 500 V	
		50 a. 60 Hz	50 a. 60 Hz	50 a. 60 Hz	50 a. 60 Hz	100-300 Hz	300-500 Hz
16	3	1340	1341				
16	4		1342	1343	1344		
16	5			31			
32	3	1345	1346				
32	4		1347	1348	1349		
32	5			32			



Wall mounted socket
screwless, with TwinCONTACT,
suitable for through wiring, internal
fixing, 4 p and 5 p sockets the
enclosure base can be turned 180°

IP 44
Std. Pack. Qty: 10
Drawing: 1 MB 209

A	P	110 V	230 V	400 V	500 V	>50 - 500 V	
		50 a. 60 Hz	50 a. 60 Hz	50 a. 60 Hz	50 a. 60 Hz	100-300 Hz	300-500 Hz
16	3	1719	1720	1721			
16	4		1723	1724	1725	1726	1727
16	5		1730	3331			



Wall mounted socket
screwless, with TwinCONTACT,
suitable for through wiring,
internal fixing, enclosure base can
be turned 180°

IP 44
Std. Pack. Qty: 10
Drawing: 1 MB 43

A	P	110 V	230 V	400 V	500 V	>50 - 500 V	
		50 a. 60 Hz	50 a. 60 Hz	50 a. 60 Hz	50 a. 60 Hz	100-300 Hz	300-500 Hz
16	4	1750	1751	418	1752	1753	1754
16	5	1755	1756	419	1757		
32	3	1851	420	1852			
32	4	1855	1856	421	1857	1858	1859
32	5	1860	1861	422	1862		1864



Wall mounted socket
screwless, with TwinCONTACT, highly
resistant to chemicals, suitable for
through wiring, with 2 external fixing
points, sockets are designed for
adding an auxiliary contact switch,
enclosure base can be turned 180°

IP 67
Std. Pack. Qty: 10
Drawing: 1 MB 622

A	P	110 V	230 V	400 V	500 V	>50 - 500 V	
		50 a. 60 Hz	50 a. 60 Hz	50 a. 60 Hz	50 a. 60 Hz	100-300 Hz	300-500 Hz
16	3	9104	9105	9106			
16	4	9120	9121	9122	9123	9124	9125
16	5	9140	9141	9142			
32	3	9150	9151	9152			
32	4	9170	9171	9172	9173	9174	9175
32	5	9180	9181	9182			



Double Box
screwless, with TwinCONTACT,
CEE and socket SCHUKO®
in one enclosure

IP 67
Std. Pack. Qty: 10
Drawing: 1 MB 622

A	P	110 V	230 V	400 V	500 V	>50 - 500 V	
		50 a. 60 Hz	50 a. 60 Hz	50 a. 60 Hz	50 a. 60 Hz	100-300 Hz	300-500 Hz
16	4		1647	1648			
16	5			1649			



Double Box
screwless, with TwinCONTACT,
CEE and socket SCHUKO®
in one enclosure, with fuse holder,
max. 10 A H, also available with
French/Belgian, Danish and Swiss
standards

IP 44
Std. Pack. Qty: 5
Drawing: 1 MB 354

A	P	110 V	230 V	400 V	500 V	>50 - 500 V	
		50 a. 60 Hz	50 a. 60 Hz	50 a. 60 Hz	50 a. 60 Hz	100-300 Hz	300-500 Hz
16	5			1650			
32	5			1651			

Sockets – Wall mounted, switched and interlocked or fused

to DIN VDE 0623, EN 60309-2.  Highly resistant to chemicals. Other voltages and frequencies available on request.
For drawings and dimensions see page 102 - 110. Products with pilot contact available on request.



Wall mounted socket
switched, with mechanical
DUO-interlock

IP 44
Std. Pack. Qty: 1
Drawing: 1 MB 174

A	P	110 V	230 V	400 V	500 V	>50 - 500 V	
		50 a. 60 Hz	50 a. 60 Hz	50 a. 60 Hz	50 a. 60 Hz	100-300 Hz	300-500 Hz
16	3	7010A	7002A				
16	4	5457A	5099A	5100A	5101A		
16	5	5459A	5102A	5103A			
32	3	5743A	5696A				
32	4	5460A	5104A	5105A	5106A		
32	5	5462A	5107A	5108A			



Wall mounted socket
X-CONTACT,
switched, with mechanical
DUO-interlock

IP 44
Std. Pack. Qty: 1
Drawing: 1 MB 234

A	P	110 V	230 V	400 V	500 V	>50 - 500 V	
		50 a. 60 Hz	50 a. 60 Hz	50 a. 60 Hz	50 a. 60 Hz	100-300 Hz	300-500 Hz
63	3		6571				
63	4		5955A	5956A	5957A		
63	5			5959A			



Wall mounted socket
switched, with mechanical
DUO-interlock

IP 44
Std. Pack. Qty: 1
Drawing: 1 MB 550

A	P	110 V	230 V	400 V	500 V	>50 - 500 V	
		50 a. 60 Hz	50 a. 60 Hz	50 a. 60 Hz	50 a. 60 Hz	100-300 Hz	300-500 Hz
16	3	7602	7603				
16	4		7604	7605	7606		
16	5			7607			
32	3	7611	7612				
32	4		7613	7614	7615		
32	5			7616			



Wall mounted socket
switched, with mechanical
DUO-interlock

IP 67
Std. Pack. Qty: 1
Drawing: 1 MB 207

A	P	110 V	230 V	400 V	500 V	>50 - 500 V	
		50 a. 60 Hz	50 a. 60 Hz	50 a. 60 Hz	50 a. 60 Hz	100-300 Hz	300-500 Hz
16	3	7011A	7012A				
16	4		5599A	5600A	5601A		
16	5		5602A	5603A			
32	3	5924A	5793A				
32	4		5604A	5605A	5606A		
32	5		5607A	5608A			



Wall mounted socket
highly resistant to chemicals, highly
heat resistant contact carrier, nickel
plated contacts, with mechanical
DUO-interlock

IP 67
Std. Pack. Qty: 1
Drawing: 1 MB 207

A	P	110 V	230 V	400 V	500 V	>50 - 500 V	
		50 a. 60 Hz	50 a. 60 Hz	50 a. 60 Hz	50 a. 60 Hz	100-300 Hz	300-500 Hz
16	3	7388	7283				
16	4			7284			
16	5			7285			
32	3		7286				
32	4			7287			
32	5			7288			





Wall mounted socket
X-CONTACT,
switched, with mechanical
DUO-interlock

IP 67
Std. Pack. Qty: 1
Drawing: 1 MB 180

A	P	110 V	230 V	400 V	500 V	>50 - 500 V	
		50 a. 60 Hz	50 a. 60 Hz	50 a. 60 Hz	50 a. 60 Hz	100-300 Hz	300-500 Hz
63	3	5925A	5911A				
63	4		5109A	5110A	5111A		
63	5		5112A	5113A	5759A		

Sockets – Wall mounted, switched and interlocked or fused

to DIN VDE 0623, EN 60309-2.  Highly resistant to chemicals. Other voltages and frequencies available on request. For drawings and dimensions see page 102 - 110.



Wall mounted socket
X-CONTACT,
highly resistant to chemicals, highly heat resistant contact carrier, nickel plated contacts, with mechanical DUO-interlock

IP 67
Std. Pack. Qty: 1
Drawing: 1 MB 180

A	P	110 V 50 a. 60 Hz	230 V 50 a. 60 Hz	400 V 50 a. 60 Hz	500 V 50 a. 60 Hz	>50 - 500 V 100-300 Hz 300-500 Hz	
63	4			7289			
63	5			7290			



Wall mounted socket
X-CONTACT,
switched, with mechanical DUO-interlock

IP 67
Std. Pack. Qty: 1
Drawing: 1 MB 177

A	P	110 V 50 a. 60 Hz	230 V 50 a. 60 Hz	400 V 50 a. 60 Hz	500 V 50 a. 60 Hz	>50 - 500 V 100-300 Hz 300-500 Hz	
125	3	7060	7000				
125	4		5887A	5691A	5690A		
125	5		5888A	5692A			



Wall mounted socket
interruptible, avec verrouillage mécanique DUO

IP 67
Std. Pack. Qty: 1
Drawing: 1 MB 551

A	P	110 V 50 a. 60 Hz	230 V 50 a. 60 Hz	400 V 50 a. 60 Hz	500 V 50 a. 60 Hz	>50 - 500 V 100-300 Hz 300-500 Hz	
16	3	7620	7621				
16	4		7623	7624	7625		
16	5			7626			
32	3	7628	7629				
32	4		7633	7634	7635		
32	5			7636			

DUO mechanical.

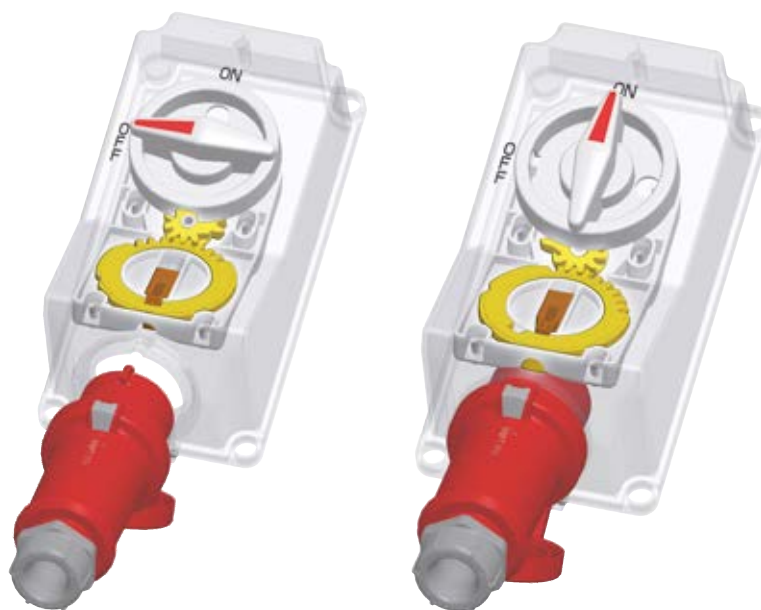

After insertion and switching on, the plug is locked in the ON position.
After switching OFF and withdrawing the plug, the switch is locked.

Sockets – Wall mounted, switched and interlocked or fused

to DIN VDE 0623, EN 60309-2.  Highly resistant to chemicals. Other voltages and frequencies available on request.
For drawings and dimensions see page 102 - 110. Products with pilot contact available on request.



Wall mounted socket

highly resistant to chemicals, highly heat resistant contact carrier, nickel plated contacts, switched, with mechanical DUO-interlock, DIN-rail

IP 67

Std. Pack. Qty: 1
Drawing: 1 MB 181/620



A	P	110 V 50 a. 60 Hz	230 V 50 a. 60 Hz	400 V 50 a. 60 Hz	500 V 50 a. 60 Hz	>50 - 500 V 100-300 Hz 300-500 Hz	
16	3	7051ZC	7394				
16	4			7291ZA			
16	5			7292			
32	3		7356				
32	4			7293ZA			
32	5			7294			



Wall mounted socket

X-CONTACT,
highly resistant to chemicals, highly heat resistant contact carrier, nickel plated contacts, switched, with mechanical DUO-interlock, DIN-rail

IP 67

Std. Pack. Qty: 1
Drawing: 1 MB 181/620



A	P	110 V 50 a. 60 Hz	230 V 50 a. 60 Hz	400 V 50 a. 60 Hz	500 V 50 a. 60 Hz	>50 - 500 V 100-300 Hz 300-500 Hz	
63	4			7295			
63	5			7296			



Wall mounted socket

protected by 1 RCD 30 mA

IP 44

Std. Pack. Qty: 1
Drawing: 1 MB 168

A	P	110 V 50 a. 60 Hz	230 V 50 a. 60 Hz	400 V 50 a. 60 Hz	500 V 50 a. 60 Hz	>50 - 500 V 100-300 Hz 300-500 Hz	
16	3	7123	7125				
16	4			7126			
16	5			7312			
32	3	7124	7469				
32	4			7127			
32	5			7313			



Wall mounted socket

protected by 1 RCD 30 mA

IP 67

Std. Pack. Qty: 1
Drawing: 1 MB 378

A	P	110 V 50 a. 60 Hz	230 V 50 a. 60 Hz	400 V 50 a. 60 Hz	500 V 50 a. 60 Hz	>50 - 500 V 100-300 Hz 300-500 Hz	
16	3		7148				
16	4			7149			
16	5			7150			
32	4			7151			
32	5			7152			



Wall mounted socket

protected by 1 "C"-type MCB

IP 44

Std. Pack. Qty: 1
Drawing: 1 MB 531

A	P	110 V 50 a. 60 Hz	230 V 50 a. 60 Hz	400 V 50 a. 60 Hz	500 V 50 a. 60 Hz	>50 - 500 V 100-300 Hz 300-500 Hz	
16	3		910253				



Wall mounted socket

protected by 1 RCD 30 mA
and 1 "C"-type MCB

IP 44

Std. Pack. Qty: 1
Drawing: 1 MB 521

A	P	110 V 50 a. 60 Hz	230 V 50 a. 60 Hz	400 V 50 a. 60 Hz	500 V 50 a. 60 Hz	>50 - 500 V 100-300 Hz 300-500 Hz	
16	5			920958			
32	4			920961			
32	5			920962			

Sockets – Wall mounted, switched and interlocked or fused

to DIN VDE 0623, EN 60309-2.  Highly resistant to chemicals. Other voltages and frequencies available on request. For drawings and dimensions see page 111 - 112. Products with pilot contact available on request.



Wall mounted socket
protected by 1 RCD 30 mA

IP 44
Std. Pack. Qty: 1
Drawing: 1 MB 531/ 1 MB 521

A	P	110 V 50 a. 60 Hz	230 V 50 a. 60 Hz	400 V 50 a. 60 Hz	500 V 50 a. 60 Hz	>50 - 500 V 100-300 Hz 300-500 Hz	
16	3		910244				
16	4			920836			
16	5			920838			
32	3	920845	920839				
32	4			920840			
32	5			920841			



Wall mounted socket
protected by 1 RCD 30 mA
and 1 "C"-type MCB

IP 44
Std. Pack. Qty: 1
Drawing: 1 MB 531/ 1 MB 521

A	P	110 V 50 a. 60 Hz	230 V 50 a. 60 Hz	400 V 50 a. 60 Hz	500 V 50 a. 60 Hz	>50 - 500 V 100-300 Hz 300-500 Hz	
16	3	910245	910246				
16	4			920859			
16	5			920860			
32	3	920861	920862				
32	4			920863			
32	5			920864			



Wall mounted socket
switched, with mechanical
DUO-interlock,
protected by 1 RCD 30 mA

IP 67
Std. Pack. Qty: 1
Drawing: 1 MB 521

A	P	110 V 50 a. 60 Hz	230 V 50 a. 60 Hz	400 V 50 a. 60 Hz	500 V 50 a. 60 Hz	>50 - 500 V 100-300 Hz 300-500 Hz	
16	3	921380	922452				
16	4			922517			
16	5			922453			
32	3	922519	921442				
32	4			922518			
32	5			922218			



Wall mounted socket
switched, with mechanical
DUO-interlock,
protected by 2 RCD's 30 mA

IP 67
Std. Pack. Qty: 1
Drawing: 1 MB 522

A	P	110 V 50 a. 60 Hz	230 V 50 a. 60 Hz	400 V 50 a. 60 Hz	500 V 50 a. 60 Hz	>50 - 500 V 100-300 Hz 300-500 Hz	
16	3		931539				
16	5			932459			
32	3		934285				
32	4			931975			
32	5			932285			



Wall mounted socket
protected by 1 RCD 30 mA

IP 67
Std. Pack. Qty: 1
Drawing: 1 MB 521

A	P	110 V 50 a. 60 Hz	230 V 50 a. 60 Hz	400 V 50 a. 60 Hz	500 V 50 a. 60 Hz	>50 - 500 V 100-300 Hz 300-500 Hz	
16	3	920700	920649				
16	4			920791			
16	5			920278			
32	3		921160				
32	4			923296			
32	5			921953			





Wall mounted socket
highly resistant to chemicals,
protected by 1 RCD 30 mA

IP 67
Std. Pack. Qty: 1
Drawing: 1 MB 521

A	P	110 V 50 a. 60 Hz	230 V 50 a. 60 Hz	400 V 50 a. 60 Hz	500 V 50 a. 60 Hz	>50 - 500 V 100-300 Hz 300-500 Hz	
16	3	933273	920821				
16	4			923274			
16	5			923275			
32	3		923276				
32	4			923297			
32	5			923277			

Sockets – Wall mounted, switched and interlocked or fused

to DIN VDE 0623, EN 60309-2.  Highly resistant to chemicals. Other voltages and frequencies available on request.
For drawings and dimensions see page 102 - 110. Products with pilot contact available on request.



Wall mounted socket
X-CONTACT,
protected by 1 RCD 30 mA

IP 67
Std. Pack. Qty: 1
Drawing: 1 MB 521

A	P	110 V 50 a. 60 Hz	230 V 50 a. 60 Hz	400 V 50 a. 60 Hz	500 V 50 a. 60 Hz	>50 - 500 V 100-300 Hz 300-500 Hz	
63	3		920666				
63	4			920668			
63	5			920670			



Wall mounted socket
X-CONTACT,
highly resistant to chemicals,
protected by 1 RCD 30 mA

IP 67
Std. Pack. Qty: 1
Drawing: 1 MB 521

A	P	110 V 50 a. 60 Hz	230 V 50 a. 60 Hz	400 V 50 a. 60 Hz	500 V 50 a. 60 Hz	>50 - 500 V 100-300 Hz 300-500 Hz	
63	3		922520				
63	4			922521			
63	5			922522			



Wall mounted socket
switched, with mechanical
DUO-interlock, protected by
1 RCD 30 mA

IP 67
Std. Pack. Qty: 1
Drawing: 1 MB 181/620

A	P	110 V 50 a. 60 Hz	230 V 50 a. 60 Hz	400 V 50 a. 60 Hz	500 V 50 a. 60 Hz	>50 - 500 V 100-300 Hz 300-500 Hz	
16	3	7393UK	7245UK				
16	4			7246UK			
16	5			7247UK			
32	3	7434	7470UK				
32	4			7248UK			
32	5			7249UK			



Wall mounted socket
switched, with mechanical
DUO-interlock, protected by
1 RCD 30 mA and
1 "K"-type MCB

IP 67
Std. Pack. Qty: 1
Drawing: 1 MB 181/620

A	P	110 V 50 a. 60 Hz	230 V 50 a. 60 Hz	400 V 50 a. 60 Hz	500 V 50 a. 60 Hz	>50 - 500 V 100-300 Hz 300-500 Hz	
16	3		7252				
16	4			7253			
16	5			7254UK			
32	3	7392	7386				
32	4			7255			
32	5			7256UK			



Wall mounted socket
X-CONTACT,
switched, with mechanical
DUO-interlock, protected by
1 RCD 30 mA

IP 67
Std. Pack. Qty: 1
Drawing: 1 MB 181/620

A	P	110 V 50 a. 60 Hz	230 V 50 a. 60 Hz	400 V 50 a. 60 Hz	500 V 50 a. 60 Hz	>50 - 500 V 100-300 Hz 300-500 Hz	
63	3		7260				
63	4			7250			
63	5			7251			



Wall mounted socket
X-CONTACT,
switched, with mechanical
DUO-interlock, protected by
1 RCD 30 mA and
1 "K"-type MCB

IP 67
Std. Pack. Qty: 1
Drawing: 1 MB 181/620

A	P	110 V 50 a. 60 Hz	230 V 50 a. 60 Hz	400 V 50 a. 60 Hz	500 V 50 a. 60 Hz	>50 - 500 V 100-300 Hz 300-500 Hz	
63	4			7257			
63	5			7258			

Sockets – Wall mounted, switched and interlocked or fused

to DIN VDE 0623, EN 60309-2. Other voltages and frequencies available on request.
For drawings and dimensions see page 102 - 110. Products with pilot contact available on request.



Wall mounted socket
X-CONTACT,
switched, with mechanical
DUO-interlock, protected by
1 RCD 30 mA, add-on equipment is
required to install a padlock

IP 67
Std. Pack. Qty: 1
Drawing: 1 MB 177

A	P	110 V 50 a. 60 Hz	230 V 50 a. 60 Hz	400 V 50 a. 60 Hz	500 V 50 a. 60 Hz	>50 - 500 V 100-300 Hz 300-500 Hz	
125	3		7000AM				
125	4			5691AM			
125	5			5692AM			



Wall mounted socket
X-CONTACT,
switched, with mechanical
DUO-interlock, protected by
1 RCD 100 mA, add-on equipment
is required to install a padlock

IP 67
Std. Pack. Qty: 1
Drawing: 1 MB 177

A	P	110 V 50 a. 60 Hz	230 V 50 a. 60 Hz	400 V 50 a. 60 Hz	500 V 50 a. 60 Hz	>50 - 500 V 100-300 Hz 300-500 Hz	
125	3		52033				
125	4			52034			
125	5			52035			

2



Video:
X-CONTACT



Get more information on the new
generation of contact sleeves:
on pages 10/11 or at
www.mennekes.org/x-contact



Sockets – Cepex

to DIN VDE 0623, EN 60309-2. Other voltages and frequencies available on request. For drawings and dimensions see page 102 - 110.



Wall mounted socket Cepex
grey, amend index YA to part number for version without rubber gland

IP 44
Std. Pack. Qty: 5
Drawing: 1 MB 312

A	P	110 V	230 V	400 V	500 V	>50 - 500 V	
		50 a. 60 Hz	50 a. 60 Hz	50 a. 60 Hz	50 a. 60 Hz	100-300 Hz	300-500 Hz
16	3	4101	4102				
16	4		4254	4103	4104		
16	5			4105			
32	3	4106	4107				
32	4			4108			
32	5			4110			



Wall mounted socket Cepex
grey, with labelling field

IP 44
Std. Pack. Qty: 5
Drawing: 1 MB 317

A	P	110 V	230 V	400 V	500 V	>50 - 500 V	
		50 a. 60 Hz	50 a. 60 Hz	50 a. 60 Hz	50 a. 60 Hz	100-300 Hz	300-500 Hz
16	3		4132				
16	4			4133			
16	5			4135			
32	3		4137				
32	4			4138			
32	5			4140			



Panel mounted socket Cepex
pearl white

IP 44
Std. Pack. Qty: 5
Drawing: 1 MB 315

A	P	110 V	230 V	400 V	500 V	>50 - 500 V	
		50 a. 60 Hz	50 a. 60 Hz	50 a. 60 Hz	50 a. 60 Hz	100-300 Hz	300-500 Hz
16	3	4111	4112				
16	4		4233	4113	4114		
16	5			4115			
32	3	4116	4117				
32	4			4118	4119		
32	5			4120			



Flush mounted socket Cepex
pearl white, with flush mounted installation box

IP 44
Std. Pack. Qty: 5
Drawing: 1 MB 336

A	P	110 V	230 V	400 V	500 V	>50 - 500 V	
		50 a. 60 Hz	50 a. 60 Hz	50 a. 60 Hz	50 a. 60 Hz	100-300 Hz	300-500 Hz
16	3	4121	4122				
16	4		4205	4123	4124		
16	5			4125			
32	3	4126	4127				
32	4			4128			
32	5			4130			



Cepex double socket
grey, amend index YA to part number for version without rubber gland

IP 44
Std. Pack. Qty: 5/4
Drawing: 1 MB 350

A	P	110 V	230 V	400 V	500 V	>50 - 500 V	
		50 a. 60 Hz	50 a. 60 Hz	50 a. 60 Hz	50 a. 60 Hz	100-300 Hz	300-500 Hz
16	3	4218	4219				
16	4		4258	4220			
16	5			4204			
32	3		4224				
32	4		4259				
32	5			4226			



N.B.: All above mentioned types are available in three designs and with SCHUKO® insert:

- with smooth cover
- with labelling field
- with labelling field and lockable cover

Also available with data port inserts. For products see page 80.
Distance frame on request.
Cepex range panel sockets rated 16 A and 32 A have the same dimensions.
It is, therefore, possible to interchange single or 3 phase sockets on a 2-gang enclosure to suit your own requirements.

Sockets – Panel mounted, with screw terminals

to DIN VDE 0623, EN 60309-2. Other voltages and frequencies available on request. For drawings and dimensions see page 102 - 110. Products with pilot contact available on request.



Panel mounted socket
flange 75 x 75 mm, straight

IP 44
Std. Pack. Qty: 10
Drawing: 1 MB 464

A	P	110 V 50 a. 60 Hz	230 V 50 a. 60 Hz	400 V 50 a. 60 Hz	500 V 50 a. 60 Hz	>50 - 500 V 100-300 Hz 300-500 Hz
16	3	1365	1366	1367		3054 3055
16	4	1388	1389	1390	1391	1392 1393
16	5	1384	1386	1385	3057	3059 3060
32	3	1394	1395	1396		
32	4	1397	1398	1399	1400	1401 1402
32	5	3449	3454	3451	3452	3455 3447



Panel mounted socket
X-CONTACT,
flange 107 x 110 mm, straight

IP 44
Std. Pack. Qty: 5
Drawing: 1 MB 211

A	P	110 V 50 a. 60 Hz	230 V 50 a. 60 Hz	400 V 50 a. 60 Hz	500 V 50 a. 60 Hz	>50 - 500 V 100-300 Hz 300-500 Hz
63	3	1260A	1261A			
63	4		1247A	1248A	1249A	
63	5			1252A		



Panel mounted socket
flange 16 A, 3 p: 73.5 x 64 mm,
16 A, 4 + 5 p, 32 A: 100 x 92 mm,
inclination 20°, 32 A: sockets
optional fitted with auxiliary contact

IP 44
Std. Pack. Qty: 10
Drawing: 1 MB 260

A	P	110 V 50 a. 60 Hz	230 V 50 a. 60 Hz	400 V 50 a. 60 Hz	500 V 50 a. 60 Hz	>50 - 500 V 100-300 Hz 300-500 Hz
16	3	1462	1463	1464		3186 3187
16	4	1465	1466	1467	1468	1469 1470
16	5	1471	1472	1473	3188	3189 3190
32	3	1491	1492	1493		3201 3202
32	4	1494	1495	1496	1497	1486 1487
32	5	1498	1499	1500	3191	3192 3193



Panel mounted socket
X-CONTACT,
flange 110 x 106 mm,
inclination 20°

IP 44
Std. Pack. Qty: 5
Drawing: 1 MB 297

A	P	110 V 50 a. 60 Hz	230 V 50 a. 60 Hz	400 V 50 a. 60 Hz	500 V 50 a. 60 Hz	>50 - 500 V 100-300 Hz 300-500 Hz
63	3	1146A	1147A	1148A		
63	4	1149A	1150A	1151A	1152A	
63	5	1153A	1154A	1155A		



Panel mounted socket
standard flange,
dimensions 85 x 85 mm,
20° inclination

IP 44
Std. Pack. Qty: 10
Drawing: 1 MB 453

A	P	110 V 50 a. 60 Hz	230 V 50 a. 60 Hz	400 V 50 a. 60 Hz	500 V 50 a. 60 Hz	>50 - 500 V 100-300 Hz 300-500 Hz
16	3	3031	3036			
16	4			3072	3074	
16	5			3093		
32	3	3110	3112		3137	
32	4		3140	3136	3114	
32	5			3153		



Panel mounted socket
miniflange: 68 x 62 mm,
inclination 20°

IP 44
Std. Pack. Qty: 10
Drawing: 1 MB 472

A	P	110 V 50 a. 60 Hz	230 V 50 a. 60 Hz	400 V 50 a. 60 Hz	500 V 50 a. 60 Hz	>50 - 500 V 100-300 Hz 300-500 Hz
16	3	858	857			

Sockets – Panel mounted, with screw terminals

to DIN VDE 0623, EN 60309-2. Other voltages and frequencies available on request. For drawings and dimensions see page 102 - 110.
Products with pilot contact available on request.



Panel mounted socket
flange 16 A: 75 x 75 mm,
32 A: 85 x 75 mm, straight

IP 67
Std. Pack. Qty: 10
Drawing: 1 MB 141

A	P	110 V	230 V	400 V	500 V	>50 - 500 V	
		50 a. 60 Hz	50 a. 60 Hz	50 a. 60 Hz	50 a. 60 Hz	100-300 Hz	300-500 Hz
16	3	217A	218A	219A			
16	4	220A	221A	222A	223A	224A	225A
16	5	226A	227A	228A			
32	3	229A	230A	231A			
32	4	232A	233A	234A	235A	236A	237A
32	5	238A	239A	240A			



Panel mounted socket
X-CONTACT,
flange 63 A: 107 x 100 mm,
125 A: 130 x 130 mm, straight

IP 67
Std. Pack. Qty: 5
Drawing: 1 MB 212/258

A	P	110 V	230 V	400 V	500 V	>50 - 500 V	
		50 a. 60 Hz	50 a. 60 Hz	50 a. 60 Hz	50 a. 60 Hz	100-300 Hz	300-500 Hz
63	3	1263A	1264A	1265A			
63	4	1122A	1123A	1124A	1125A		
63	5	1126A	1127A	1128A			
125	3		3380				
125	4	1455	1456	1457	1458		
125	5	1459	1460	1461	3283		



Panel mounted socket
flange 16 A, 3 p: 73.5 x 64 mm,
16 A, 4 + 5 p, 32 A: 100 x 92 mm,
inclination 20°, 32 A sockets
optional fitted with auxiliary contact

IP 67
Std. Pack. Qty: 10
Drawing: 1 MB 251

A	P	110 V	230 V	400 V	500 V	>50 - 500 V	
		50 a. 60 Hz	50 a. 60 Hz	50 a. 60 Hz	50 a. 60 Hz	100-300 Hz	300-500 Hz
16	3	1474	1475	1476			
16	4	1477	1478	1479	1480	1481	1482
16	5	1483	1484	1485			
32	3	1501	1502	1503			
32	4	1504	1505	1506	1507	1567	1568
32	5	1489	1490	1551			



Panel mounted socket
X-CONTACT,
flange 63 A: 110 x 106 mm,
inclination 20°,
125 A: 114 x 110 mm,
inclination 15°

IP 67
Std. Pack. Qty: 5
Drawing: 1 MB 298/601

A	P	110 V	230 V	400 V	500 V	>50 - 500 V	
		50 a. 60 Hz	50 a. 60 Hz	50 a. 60 Hz	50 a. 60 Hz	100-300 Hz	300-500 Hz
63	3	2179A	2180A	2181A			
63	4	203A	204A	205A	206A		
63	5	207A	208A	209A	3507		
125	3		3575				
125	4	210A	211A	212A	213A		
125	5	214A	215A	216A			



Panel mounted socket
standard flange dimensions
85 x 85 mm, inclination 20°,
optional fitted with auxiliary contact

IP 67
Std. Pack. Qty: 10
Drawing: 1 MB 452

A	P	110 V	230 V	400 V	500 V	>50 - 500 V	
		50 a. 60 Hz	50 a. 60 Hz	50 a. 60 Hz	50 a. 60 Hz	100-300 Hz	300-500 Hz
16	3	903	905				
16	4			1081	1082		
16	5			1103			
32	3	3197	3200				
32	4			3254	3256		
32	5			3524			



Auxiliary contact
for standard sockets
and panel mounted
sockets 16 A and 32 A

Std. Pack. Qty: 10

Part no.	
41000	

Sockets – Panel mounted, screwless, with TwinCONTACT

to DIN VDE 0623, EN 60309-2. Other voltages and frequencies available on request. For drawings and dimensions see page 102 - 110.



Panel mounted socket
screwless, with TwinCONTACT,
flange 75 x 75 mm, straight

IP 44
Std. Pack. Qty: 10
Drawing: 1 MB 464

A	P	110 V 50 a. 60 Hz	230 V 50 a. 60 Hz	400 V 50 a. 60 Hz	500 V 50 a. 60 Hz	>50 - 500 V 100-300 Hz 300-500 Hz
16	3	1667	1668	1669		1671
16	4	1672	1673	1674	1675	1676 1677
16	5	1678	1679	3385	1680	
32	3	1786	1787	1788		1682
32	4	1789	1790	1791	1792	1793 1794
32	5	1795	1796	1797	1798	



Panel mounted socket
screwless, with TwinCONTACT,
flange 16 A, 3 p: 73.5 x 64 mm,
16 A, 4 + 5 p, 32 A: 100 x 92 mm,
inclination 20°, 32 A: optional fitted
with auxiliary contact

IP 44
Std. Pack. Qty: 10
Drawing: 1 MB 465

A	P	110 V 50 a. 60 Hz	230 V 50 a. 60 Hz	400 V 50 a. 60 Hz	500 V 50 a. 60 Hz	>50 - 500 V 100-300 Hz 300-500 Hz
16	3	1631	1632	1633		1635
16	4	1636	1637	1638	1639	1640 1641
16	5	1642	1643	3473	1644	
32	3	1733	1734	1735		1737
32	4	1738	1739	1740	1741	1742 1743
32	5	1744	1745	1746	1747	



Panel mounted socket
screwless, with TwinCONTACT,
standard flange dimensions
85 x 85 mm, 20° inclination,
optional fitted with auxiliary contact

IP 44
Std. Pack. Qty: 10
Drawing: 1 MB 519

A	P	110 V 50 a. 60 Hz	230 V 50 a. 60 Hz	400 V 50 a. 60 Hz	500 V 50 a. 60 Hz	>50 - 500 V 100-300 Hz 300-500 Hz
16	3	3004	3008			
16	4			3048	3049	
16	5			3070		
32	3	3124	3126			
32	4			3155	3157	
32	5			3171		



Panel mounted socket
screwless, with TwinCONTACT,
miniflange: 55 x 55 mm, straight

IP 44
Std. Pack. Qty: 10
Drawing: 1 MB 426

A	P	110 V 50 a. 60 Hz	230 V 50 a. 60 Hz	400 V 50 a. 60 Hz	500 V 50 a. 60 Hz	>50 - 500 V 100-300 Hz 300-500 Hz
16	3	1618	1619			



Panel mounted socket RAPIDO
screwless, with TwinCONTACT,
with central locking system,
round flange for central fixing,
diam. 61 mm

IP 44
Std. Pack. Qty: 10
Drawing: 1 MB 468

A	P	110 V 50 a. 60 Hz	230 V 50 a. 60 Hz	400 V 50 a. 60 Hz	500 V 50 a. 60 Hz	>50 - 500 V 100-300 Hz 300-500 Hz
16	3	1132	997			



Panel mounted socket RAPIDO
screwless, with TwinCONTACT,
with central locking system,
round flange for central fixing,
diam. 70 mm

IP 44
Std. Pack. Qty: 10
Drawing: 1 MB 468

A	P	110 V 50 a. 60 Hz	230 V 50 a. 60 Hz	400 V 50 a. 60 Hz	500 V 50 a. 60 Hz	>50 - 500 V 100-300 Hz 300-500 Hz
16	4		1133	998	1134	
16	5			907		
32	3	1135	987			
32	4		1166	988	1167	
32	5			989		

Sockets – Panel mounted sockets, screwless, with TwinCONTACT

to DIN VDE 0623, EN 60309-2. Other voltages and frequencies available on request. For drawings and dimensions see page 102 - 110.



Panel mounted socket
screwless, with TwinCONTACT,
flange: 16 A: 75 x 75 mm,
32 A: 85 x 75 mm, straight

IP 67
Std. Pack. Qty: 10
Drawing: 1 MB 467

A	P	110 V	230 V	400 V	500 V	>50 - 500 V	
		50 a. 60 Hz	50 a. 60 Hz	50 a. 60 Hz	50 a. 60 Hz	100-300 Hz	300-500 Hz
16	3	1707	1708	1709			
16	4	1710	1711	1712	1713	1714	1715
16	5	1716	1717	1131			
32	3	1809	1810	1811			
32	4	1812	1813	1814	1815	1816	1817
32	5	1818	1819	1820			



Panel mounted socket
screwless, with TwinCONTACT,
flange: 16 A, 3 p: 73.5 x 64 mm,
16 A, 4 + 5 p, 32 A: 100 x 92 mm,
inclination 20°. 32 A: optionally fitted
with auxiliary contact

IP 67
Std. Pack. Qty: 10
Drawing: 1 MB 466

A	P	110 V	230 V	400 V	500 V	>50 - 500 V	
		50 a. 60 Hz	50 a. 60 Hz	50 a. 60 Hz	50 a. 60 Hz	100-300 Hz	300-500 Hz
16	3	1700	1701	1702			
16	4		1703	1704	1705	1706	
16	5			3485			
32	3	1801	1802	1803			
32	4		1804	1805	1806	1807	
32	5			1808			



Panel mounted socket
screwless, with TwinCONTACT,
standard flange dimensions
85 x 85 mm, inclination 20°,
optionally fitted with auxiliary contact

IP 67
Std. Pack. Qty: 10
Drawing: 1 MB 520

A	P	110 V	230 V	400 V	500 V	>50 - 500 V	
		50 a. 60 Hz	50 a. 60 Hz	50 a. 60 Hz	50 a. 60 Hz	100-300 Hz	300-500 Hz
16	3		1168				
16	4			1169	1171		
16	5			1173			
32	3	3566	3573				
32	4			3581	3587		
32	5			3590			



Auxiliary contact
for standard sockets
and panel mounted
sockets 16 A and 32 A

Std. Pack. Qty: 10

Part no.	
41000	

Auxiliary contact.



Function: Change-over contact = NC/NO

Connected load: 16 A (4 A)* / ~ 250 V
10 A (3 A)* / ~ 400 V

* for inductive or motor load

Sockets – Panel mounted sockets, switched and interlocked

to DIN VDE 0623, EN 60309-2. Other voltages and frequencies available on request. For drawings and dimensions see page 102 - 110.



Panel mounted socket
switched, with mechanical
DUO-interlock

IP 44
Std. Pack. Qty: 1
Drawing: 5 MB 59

A	P	110 V	230 V	400 V	500 V	>50 - 500 V	
		50 a. 60 Hz	50 a. 60 Hz	50 a. 60 Hz	50 a. 60 Hz	100-300 Hz	300-500 Hz
16	3	7502	7503				
16	4		7504	7505	7506		
16	5			7507			
32	3	7511	7512				
32	4		7513	7514	7515		
32	5			7516			



Panel mounted socket
switched, with mechanical
DUO-interlock

IP 67
Std. Pack. Qty: 1
Drawing: 5 MB 57

A	P	110 V	230 V	400 V	500 V	>50 - 500 V	
		50 a. 60 Hz	50 a. 60 Hz	50 a. 60 Hz	50 a. 60 Hz	100-300 Hz	300-500 Hz
16	3	7520	7521				
16	4		7523	7524	7525		
16	5			7526			
32	3	7530	7531				
32	4		7533	7534	7535		
32	5			7536			

2

X-CONTACT

The new generation of contact sleeves.



More contact

Due to a completely new manufacturing process, the X-CONTACT sleeve obtains resilient properties based solely on its material characteristics, without the need to use any additional spring elements. Thanks to the design of the X-CONTACT sleeve, a particularly safe contact closure can be achieved.



Less effort

The special design of the X-CONTACT reduces the effort of insertion and withdrawal by up to 50 %. An advantage that simplifies work processes and improves safety especially with high electrical currents. With X-CONTACT, MENNEKES creates a safe contact closure and easy handling at a new, equally high level.

Get more information on the new generation of contact sleeves at:
www.mennekes.org/x-contact

3

The X principle

Easy handling meets safe connections.

Innovative

Slotted sleeves with their resilient material properties reduces the force needed to connect and disconnect the plug by up to 50 %.

X-CONTACT – intelligently innovative!

Simple

The connection is easier to handle when compared to conventional contact sleeves.

X-CONTACT – simply brilliant!

Durable

No signs of wear, permanently fatigue-proof and self-cleaning by connecting and disconnecting.

X-CONTACT – lasting solution!

Safe

A higher degree of safety of handling – for a safe contact closure.

X-CONTACT – double safety!



PowerTOP® Xtra

Extra slip-proof. Extra shock-resistant. Extra protected.

Plugs and connectors for toughest conditions – that's PowerTOP® Xtra. The unique rubber coating of the contact surfaces and the ergonomic design guarantees best grip – even with working gloves.

Tough

The plugs provide better corrosion protection thanks to nickel plated contacts. More safety through highly heat resistant contact carrier.

Easy and fast installation

- Substantially reduced installation times through largely tool-free installation.
- Locking slides instead of screws and especially smooth cable gland with integrated strain relief, seal and protection against kinking.

Always clean, always safe

- As the cable glands are in contact with the body of the plug and connector, the areas for the ingress of dirt are reduced and allow for easy cleaning in areas where hygiene is of prime importance.
- Moulded seals in the connector lid and the front part of the plug.
- Integrated opening aid on the connector lid.



3



- Connectors with highly heat resistant contact carrier; nickel plated contact sleeves also available on request. Pilot contact standard with plugs; optionally available for connectors.



- Comfortable self-locating thread lock between front and back part.



- Stable and fast locking without screws. Unlocking only with just a tool according to the regulations.



- Safe contact: Simply insert and pull by X-CONTACT: At 63 A and 125 A.

AM-TOP and PowerTOP® for use in corrosive environments.

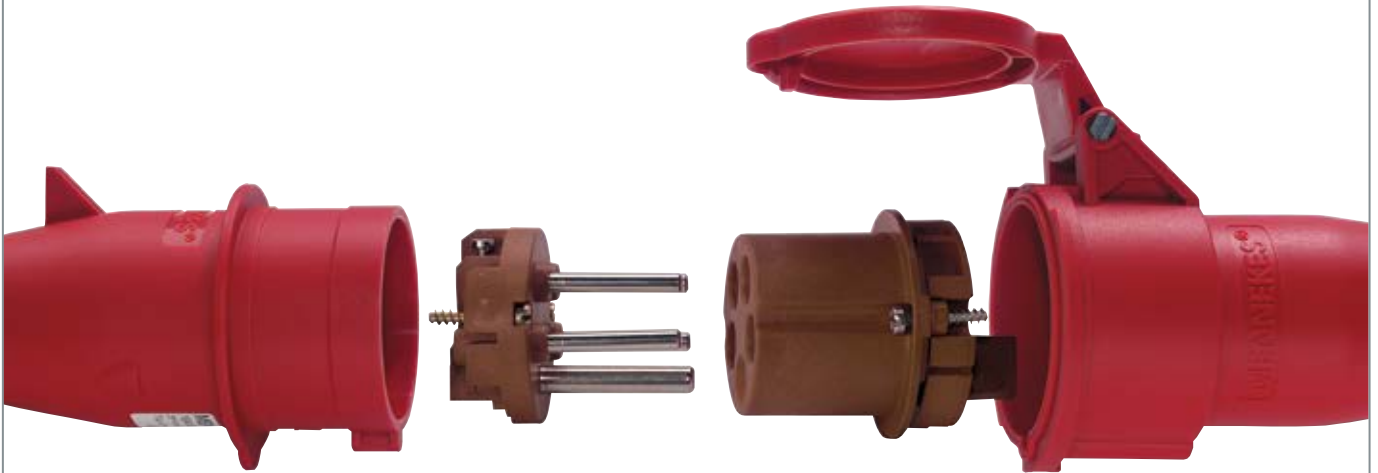

Highly heat resistant contact carrier and nickel plated contacts.

These appliances are guaranteed to be resistant to corrosive environments: High humidity, salt or acidic air, corrosive gases and vapours. Accordingly, they are mainly used **in the food processing industry, in breweries, dairies, farms and market gardens, wineries.**

3

ProTOP Convenient and reliable.

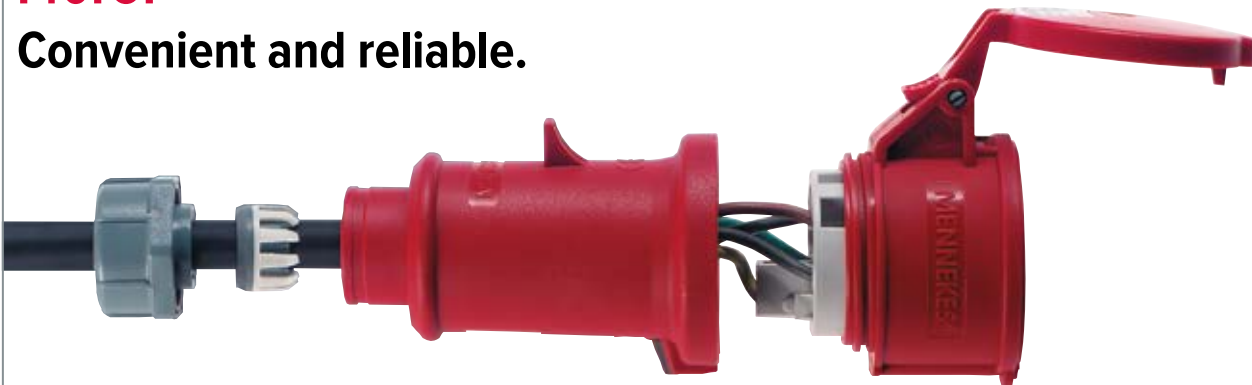

Many handy features, e.g., the self-locating thread for tight and stable connection of cover and front part.
Cable gland with internal strain relief.

Angled plug VarioTOP Ergonomic. Practical. Safe.



The first CEE angled plug with cable entry rotating up to 60° to the left or to the right.

Plugs and connectors – Plugs

to DIN VDE 0623, EN 60309-2. Other voltages and frequencies available on request.



Plug AM-TOP
single part body

IP 44
Std. Pack. Qty: 10

A	P	110 V 50 a. 60 Hz	230 V 50 a. 60 Hz	400 V 50 a. 60 Hz	500 V 50 a. 60 Hz	>50 - 500 V	
						100-300 Hz	300-500 Hz
16	3	247	248	249		2168	2271
16	4	250	251	252	253	254	255
16	5	256	257	3	2014	2189	2243
32	3	259	260	261		2195	2341
32	4	262	263	264	265	266	267
32	5	268	269	4	2015	2244	2178



Plug ProTOP
enclosure with thread lock and safety slide

IP 44
Std. Pack. Qty: 10

A	P	110 V 50 a. 60 Hz	230 V 50 a. 60 Hz	400 V 50 a. 60 Hz	500 V 50 a. 60 Hz	>50 - 500 V	
						100-300 Hz	300-500 Hz
16	3	147A	148A				
16	4		151A	152A	153A		
16	5			13A			
32	3	159	160				
32	4		163	164	165		
32	5			14A			



Plug StarTOP
screwless, with SafeCONTACT with insulation displacement technique, enclosure with thread lock and safety slide

IP 44
Std. Pack. Qty: 10

A	P	110 V 50 a. 60 Hz	230 V 50 a. 60 Hz	400 V 50 a. 60 Hz	500 V 50 a. 60 Hz	>50 - 500 V	
						100-300 Hz	300-500 Hz
16	3	947	948				
16	4		951	952	953	954	
16	5			33			
32	3	711	712				
32	4		717	719	723		
32	5			34			



Plug PowerTOP® Xtra
rubberised grip area, highly heat resistant contact carrier, frame terminals, nickel plated contacts, cable gland and sealing, strain relief and protection against kinking

IP 44
Std. Pack. Qty: 5

A	P	110 V 50 a. 60 Hz	230 V 50 a. 60 Hz	400 V 50 a. 60 Hz	500 V 50 a. 60 Hz	>50 - 500 V	
						100-300 Hz	300-500 Hz
63	3	13101	13102				
63	4		13105	13106	13107		
63	5		13111	13112			



Angled plug VariotOP
cable entry hood rotating up to 60° to the left or the right, 3981 and 3980: in colour code 3983 and 3982: in electric grey

IP 44
Std. Pack. Qty: 10

A	P	110 V 50 a. 60 Hz	230 V 50 a. 60 Hz	400 V 50 a. 60 Hz	500 V 50 a. 60 Hz	>50 - 500 V	
						100-300 Hz	300-500 Hz
16	5		3981	3980			
16	5		3983	3982			



Angled plug
with grommet

IP 44
Std. Pack. Qty: 10

A	P	110 V 50 a. 60 Hz	230 V 50 a. 60 Hz	400 V 50 a. 60 Hz	500 V 50 a. 60 Hz	>50 - 500 V	
						100-300 Hz	300-500 Hz
16	3	1410	1411	1412			
16	4	890	891	315			
32	3	3312	3306				
32	4		3646	3987			
32	5		3424	3266			

Plugs and connectors – Plugs

to DIN VDE 0623, EN 60309-2. Other voltages and frequencies available on request.



Plug AM-TOP
single part body, cable gland and sealing, strain relief and protection against kinking

IP 67
Std. Pack. Qty: 10

A	P	110 V 50 a. 60 Hz	230 V 50 a. 60 Hz	400 V 50 a. 60 Hz	500 V 50 a. 60 Hz	>50 - 500 V	
		100-300 Hz	300-500 Hz				
16	3	277	278	279			
16	4	280	281	282	283	284	285
16	5	286	287	288			
32	3	289	290	291			
32	4	292	293	294	295	296	297
32	5	298	299	300			



Plug PowerTOP®
with external grip, highly heat resistant contact carrier and nickel plated contacts

IP 67
Std. Pack. Qty: 10

A	P	110 V 50 a. 60 Hz	230 V 50 a. 60 Hz	400 V 50 a. 60 Hz	500 V 50 a. 60 Hz	>50 - 500 V	
		100-300 Hz	300-500 Hz				
16	3	3794	3796	3799			
16	4	3807	3811	3809	3810		
16	5	3819	3823	3821			
32	3	3829	3830	3832			
32	4	3839	3844	3841	3842		
32	5	3851	3855	3853			

3



Plug PowerTOP® Xtra
rubberised grip area, highly heat resistant contact carrier, frame terminals, nickel plated contacts, cable gland and sealing, strain relief and protection against kinking

IP 67
Std. Pack. Qty: 5

A	P	110 V 50 a. 60 Hz	230 V 50 a. 60 Hz	400 V 50 a. 60 Hz	500 V 50 a. 60 Hz	>50 - 500 V	
		100-300 Hz	300-500 Hz				
63	3	13201	13202	13203			
63	4	13204	13205	13206	13207	13208	13209
63	5	13210	13211	13212	13213		13214
125	3	13215	13216				
125	4	13217	13218	13219	13220		
125	5	13223	13224	13225	13226		13227



Protective cover
for IP 67 inlets and plugs

Std. Pack. Qty: 50

Description	Part no.
16 A, 3 p	40784
16 A, 4 p	40778
16 A, 5 + 7 p	40785
32 A, 3 + 4 p	40841
32 A, 5 + 7 p	40786
63 A, 3, 4 + 5 p	40787
125 A, 3, 4 + 5 p	40788



Plug guard
prevents insertion of the plug that unauthorised persons cannot use appliances or installations

Std. Pack. Qty: 1

Part no.
60757M



Plug guard.
Fits all CEE-plugs, panel mounted and wall mounted inlets from 16 A, 3 p up to 125 A, 5 p (not suitable for low voltage).

Plugs and connectors – Wall mounted inlets

to DIN VDE 0623, EN 60309-2. Other voltages and frequencies available on request. For drawings and dimensions see page 102 - 110.



Wall mounted inlet
for internal and external fixing,
for hinged lids for retrofit see
part no. 41482 and 41489

IP 44
Std. Pack. Qty: 10
Drawing: 2 MB 213

A	P	110 V	230 V	400 V	500 V	>50 - 500 V	
		50 a. 60 Hz	50 a. 60 Hz	50 a. 60 Hz	50 a. 60 Hz	100-300 Hz	300-500 Hz
16	3	843	844				



Wall mounted inlet
with hinged lid, for internal
and external fixing

IP 44
Std. Pack. Qty: 10
Drawing: 2 MB 212

A	P	110 V	230 V	400 V	500 V	>50 - 500 V	
		50 a. 60 Hz	50 a. 60 Hz	50 a. 60 Hz	50 a. 60 Hz	100-300 Hz	300-500 Hz
16	3	846	847				



Wall mounted inlet
for external fixing,
for hinged lids for retrofit see
part no. 41482 and 41489

IP 44
Std. Pack. Qty: 10
Drawing: 2 MB 221

A	P	110 V	230 V	400 V	500 V	>50 - 500 V	
		50 a. 60 Hz	50 a. 60 Hz	50 a. 60 Hz	50 a. 60 Hz	100-300 Hz	300-500 Hz
16	4			800			
16	5			801			
32	3		802				
32	4			803			
32	5			804			



Wall mounted inlet
enclosure base with stamped recess
for quick cutting out

IP 44
Std. Pack. Qty: 10
Drawing: 2 MB 32

A	P	110 V	230 V	400 V	500 V	>50 - 500 V	
		50 a. 60 Hz	50 a. 60 Hz	50 a. 60 Hz	50 a. 60 Hz	100-300 Hz	300-500 Hz
16	3	331	332	333			
16	4	334	335	336	337	921	922
16	5	340	341	342	2359	2668	2400
32	3	343	344	345			
32	4	346	347	348	349		
32	5	352	353	354	2386		



Wall mounted inlet
for a suitable watertight protective
cover for 63 A see part no. 40434

IP 67
Std. Pack. Qty: 5/3
Drawing: 2 MB 36

A	P	110 V	230 V	400 V	500 V	>50 - 500 V	
		50 a. 60 Hz	50 a. 60 Hz	50 a. 60 Hz	50 a. 60 Hz	100-300 Hz	300-500 Hz
63	3	1216	1107	1217			
63	4	355	356	357	358		
63	5	359	360	361			
125	4	362	363	364	365		
125	5	366	367	368			



Hinged lid
for retrofitting for wall mounted inlets

Std. Pack. Qty: 10

Description	Part no.
for part no. 843 and 844	41482
for part no. 800, 801 and 3517	41489

Plugs and connectors – Panel mounted inlets

to DIN VDE 0623, EN 60309-2. Other voltages and frequencies available on request. For drawings and dimensions see page 102 - 110.



Panel mounted inlet

16 A: flange 66 x 66 mm, fixing distance 52 x 52 mm, 32 A: flange 72 x 72 mm, fixing distance 60 x 60 mm, a retaining nose to hold the hinged lid of the connector must be provided by the customer in order to ensure satisfactory locking
IP 44
Std. Pack. Qty: 10
Drawing: 2 MB 68

A	P	110 V	230 V	400 V	500 V	>50 - 500 V	
		50 a. 60 Hz	50 a. 60 Hz	50 a. 60 Hz	50 a. 60 Hz	100-300 Hz	300-500 Hz
16	5			1408			
32	5			1409			



Panel mounted inlet

flange 75 x 75 mm, fixing distance: 60 x 60 mm, a retaining nose to hold the hinged lid of the connector must be provided by the customer in order to ensure satisfactory locking
IP 44
Std. Pack. Qty: 10
Drawing: 2 MB 68/853

A	P	110 V	230 V	400 V	500 V	>50 - 500 V	
		50 a. 60 Hz	50 a. 60 Hz	50 a. 60 Hz	50 a. 60 Hz	100-300 Hz	300-500 Hz
16	5			853			



Panel mounted inlet

nickel plated contacts, a retaining nose to hold the hinged lid of the connector must be provided by the customer in order to ensure satisfactory locking
IP 44
Std. Pack. Qty: 10
Drawing: 2 MB 173/2

A	P	110 V	230 V	400 V	500 V	>50 - 500 V	
		50 a. 60 Hz	50 a. 60 Hz	50 a. 60 Hz	50 a. 60 Hz	100-300 Hz	300-500 Hz
16	3		812				
16	4		837	813	814		
16	5			815			
32	3		817				
32	4		838	819	820		
32	5			821			



Panel mounted inlet

highly heat resistant contact carrier, nickel plated contacts, a retaining nose to hold the hinged lid of the connector must be provided by the customer in order to ensure satisfactory locking
IP 44
Std. Pack. Qty: 5
Drawing: 2 MB 155

A	P	110 V	230 V	400 V	500 V	>50 - 500 V	
		50 a. 60 Hz	50 a. 60 Hz	50 a. 60 Hz	50 a. 60 Hz	100-300 Hz	300-500 Hz
63	3		1981				
63	4		1984	1982	824		
63	5			1688			



Panel mounted inlet

nickel plated contacts, a retaining nose to hold the hinged lid of the connector must be provided by the customer in order to ensure satisfactory locking
IP 67
Std. Pack. Qty: 10
Drawing: 2 MB 187/2

A	P	110 V	230 V	400 V	500 V	>50 - 500 V	
		50 a. 60 Hz	50 a. 60 Hz	50 a. 60 Hz	50 a. 60 Hz	100-300 Hz	300-500 Hz
16	3	825	826				
16	4		839	827	828		
16	5			829			
32	3	830	831				
32	4		840	832	833		
32	5			834			



Panel mounted inlet

highly heat resistant contact carrier, nickel plated contacts, 63 A: a retaining nose to hold the hinged lid of the connector must be provided by the customer in order to ensure satisfactory locking
IP 67
Std. Pack. Qty: 5
Drawing: 2 MB 166

A	P	110 V	230 V	400 V	500 V	>50 - 500 V	
		50 a. 60 Hz	50 a. 60 Hz	50 a. 60 Hz	50 a. 60 Hz	100-300 Hz	300-500 Hz
63	3	835	836				
63	4		3704	3656	3657		
63	5			3658			
125	3		3665				
125	4		3413	3583	3600		
125	5			1983			

Plugs and connectors – Panel mounted inlets, phase sequence test plugs

to DIN VDE 0623, EN 60309-2. Other voltages and frequencies available on request. For drawings and dimensions see page 102 - 110.



Panel mounted inlet

IP 44
Std. Pack. Qty: 10
Drawing: 2 MB 73

A	P	110 V	230 V	400 V	500 V	>50 - 500 V	
		50 a. 60 Hz	50 a. 60 Hz	50 a. 60 Hz	50 a. 60 Hz	100-300 Hz	300-500 Hz
16	4	371	372	373	374		
16	5	377	378	379			
32	3	380	381	382			
32	4	383	384	385	386		
32	5	389	390	391			



Panel mounted inlet with hinged lid

IP 44
Std. Pack. Qty: 10
Drawing: 2 MB 43

A	P	110 V	230 V	400 V	500 V	>50 - 500 V	
		50 a. 60 Hz	50 a. 60 Hz	50 a. 60 Hz	50 a. 60 Hz	100-300 Hz	300-500 Hz
16	4	392	393	394	395		
16	5	398	399	400			
32	3	401	402	403			
32	4	404	405	406	407		
32	5	410	411	412			



Phase sequence test plug
to VDE 0413, part 7,
DIN-EN 61557-7

IP 44
Std. Pack. Qty: 5

A	P	110 V	230 V	400 V	500 V	>50 - 500 V	
		50 a. 60 Hz	50 a. 60 Hz	50 a. 60 Hz	50 a. 60 Hz	100-300 Hz	300-500 Hz
16	4		3527	3458	3459		
16	5		3231	1414			
32	4		3528	3460	3461		
32	5		3232	1415			
63	4		3420	1436	3917		
63	5			1437			

3

Phase sequence test plug

Enables safe control of the direction of the rotating field for CEE sockets.

According to VDE 0100-550 part 4.7 rotary current sockets must be connected such that a right-hand rotating field is achieved - the sockets seen from front in clockwise direction.

The test plug differs from a standard plug by its transparent enclosure indicating a right-hand or left-hand rotating field or a missing phase by means of two control lamps.

Correct rotating field: Green lamp lights up.

Incorrect rotating field: Red lamp lights up.

Phase missing: Both lamps light up.

The control lamps inside the transparent enclosure are arranged so as to be perfectly visible from all sides.



Plugs and connectors – Phase inverter plugs

to DIN VDE 0623, EN 60309-2. Other voltages and frequencies available on request.



Phase inverter plug AM-TOP
single part body, cable gland and sealing, strain relief and protection against kinking

IP 44
Std. Pack. Qty: 10

A	P	110 V 50 a. 60 Hz	230 V 50 a. 60 Hz	400 V 50 a. 60 Hz	500 V 50 a. 60 Hz	>50 - 500 V	
		100-300 Hz		300-500 Hz			
16	4		338	339			
16	5		318	319			
32	4		396	397			
32	5		321	322			



Phase inverter plug ProTOP
cable gland and sealing

IP 44
Std. Pack. Qty: 10

A	P	110 V 50 a. 60 Hz	230 V 50 a. 60 Hz	400 V 50 a. 60 Hz	500 V 50 a. 60 Hz	>50 - 500 V	
		100-300 Hz		300-500 Hz			
16	5			3319A			
32	5			3322			

3



Phase inverter plug AM-TOP
single part body

IP 67
Std. Pack. Qty: 10

A	P	110 V 50 a. 60 Hz	230 V 50 a. 60 Hz	400 V 50 a. 60 Hz	500 V 50 a. 60 Hz	>50 - 500 V	
		100-300 Hz		300-500 Hz			
16	4		3338	3339			
16	5			325			
32	4		3340	3341			
32	5		327	328			



Phase inverter plug VarioTOP
cable entry hood rotating up to 60° to the left or the right

IP 44
Std. Pack. Qty: 5

A	P	110 V 50 a. 60 Hz	230 V 50 a. 60 Hz	400 V 50 a. 60 Hz	500 V 50 a. 60 Hz	>50 - 500 V	
		100-300 Hz		300-500 Hz			
16	5			859			

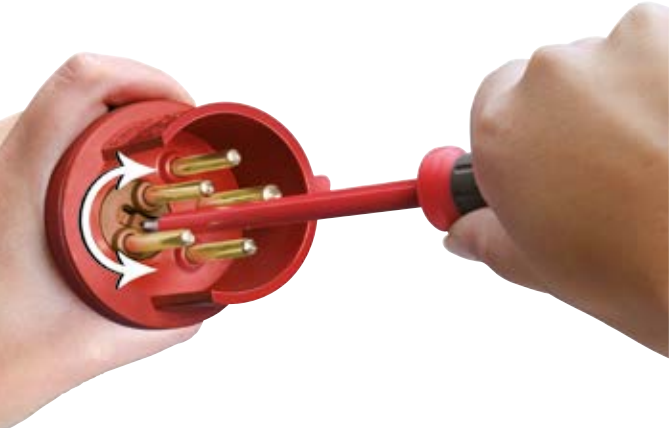

Phase inverter plug

4- and 5-pole phase inverters – making life easier.





If three phase equipment rotates in the wrong direction the MENNEKES phase inverter plug solves the problem rapidly and safely.

Simply depress the latch with a screw-driver and turn the insulating element in which the two phase pins are fitted and the motor will rotate in the correct direction. Anybody can do this – no specialised knowledge of the workings of electrical equipment is required.

Using a phase inverter to change over the two phase conductors is a recognised technique of “operating electrical equipment”. Two outer conductors rotatable through 180°.

Plugs and connectors – Phase inverter inlets

to DIN VDE 0623, EN 60309-2. Other voltages and frequencies available on request. For drawings and dimensions see page 102 - 110.

	Wall mounted phase inverter inlet		A	P	110 V 50 a. 60 Hz	230 V 50 a. 60 Hz	400 V 50 a. 60 Hz	500 V 50 a. 60 Hz	>50 - 500 V 100-300 Hz 300-500 Hz		
	16	5					3517				
	32	5					3523				
IP 44 Std. Pack. Qty: 10 Drawing: 2 MB 221											
	Wall mounted phase inverter inlet		A	P	110 V 50 a. 60 Hz	230 V 50 a. 60 Hz	400 V 50 a. 60 Hz	500 V 50 a. 60 Hz	>50 - 500 V 100-300 Hz 300-500 Hz		
	16	4				3342	3343				
	16	5					2511				
	32	4				3345	3346				
IP 44 Std. Pack. Qty: 10 Drawing: 2 MB 32											
	Panel mounted phase inverter inlet		A	P	110 V 50 a. 60 Hz	230 V 50 a. 60 Hz	400 V 50 a. 60 Hz	500 V 50 a. 60 Hz	>50 - 500 V 100-300 Hz 300-500 Hz		
	16	4				3357	855				
	16	5					329				
	32	4				3367	3368				
IP 44 Std. Pack. Qty: 10 Drawing: 2 MB 73											
	Panel mounted phase inverter inlet with hinged lid		A	P	110 V 50 a. 60 Hz	230 V 50 a. 60 Hz	400 V 50 a. 60 Hz	500 V 50 a. 60 Hz	>50 - 500 V 100-300 Hz 300-500 Hz		
	16	4				3348	3350				
	16	5					20970				
	32	4				3355	3356				
IP 44 Std. Pack. Qty: 10 Drawing: 2 MB 43											
	Panel mounted phase inverter inlet		A	P	110 V 50 a. 60 Hz	230 V 50 a. 60 Hz	400 V 50 a. 60 Hz	500 V 50 a. 60 Hz	>50 - 500 V 100-300 Hz 300-500 Hz		
	16	5					854				
flange 75 x 75 mm, fixing distance 60 x 60 mm, a retaining nose to hold the hinged lid of the connector must be provided by the customer in order to ensure satisfactory locking IP 44 Std. Pack. Qty: 10 Drawing: 2 MB 68/853											

Plugs and connectors – Connectors

to DIN VDE 0623, EN 60309-2. Other voltages and frequencies available on request. Products with pilot contact available on request.



Connector AM-TOP
single part body

* For use on camping sites, please select type 180AC

IP 44
Std. Pack. Qty: 10

A	P	110 V	230 V	400 V	500 V	>50 - 500 V	
		50 a. 60 Hz	50 a. 60 Hz	50 a. 60 Hz	50 a. 60 Hz	100-300 Hz	300-500 Hz
16	3	509	510 *	511		2441	2517
16	4	512	513	514	515	516	517
16	5	518	519	5	2026	2193	2495
32	3	521	522	523		2196	2674
32	4	524	525	526	527	528	529
32	5	530	531	6	2027	2245	2493



Connector ProTOP
cable gland and sealing

* For use on camping sites, please select type 180AC

IP 44
Std. Pack. Qty: 10

A	P	110 V	230 V	400 V	500 V	>50 - 500 V	
		50 a. 60 Hz	50 a. 60 Hz	50 a. 60 Hz	50 a. 60 Hz	100-300 Hz	300-500 Hz
16	3	179A	180A *	181A			
16	4		193A	194A	195A		
16	5			15A			
32	3	121	122				
32	4		125	126	127		
32	5			16A			

3



Connector StarTOP
screwless, with insulation displacing technique, SafeCONTACT, cable gland and sealing

* For use on camping sites, please select type 180AC

IP 44
Std. Pack. Qty: 10

A	P	110 V	230 V	400 V	500 V	>50 - 500 V	
		50 a. 60 Hz	50 a. 60 Hz	50 a. 60 Hz	50 a. 60 Hz	100-300 Hz	300-500 Hz
16	3	979	980 *				
16	4		993	994	965	996	
16	5			35			
32	3	725	731				
32	4		761	763	765		
32	5			36			



Connector PowerTOP® Xtra
X-CONTACT, rubberised grip area, frame terminals, cable gland and sealing

IP 44
Std. Pack. Qty: 5

A	P	110 V	230 V	400 V	500 V	>50 - 500 V	
		50 a. 60 Hz	50 a. 60 Hz	50 a. 60 Hz	50 a. 60 Hz	100-300 Hz	300-500 Hz
63	3	14101	14102				
63	4		14105	14106	14107		
63	5		14111	14112			



Angled Connector
with grommet

IP 44
Std. Pack. Qty: 10

A	P	110 V	230 V	400 V	500 V	>50 - 500 V	
		50 a. 60 Hz	50 a. 60 Hz	50 a. 60 Hz	50 a. 60 Hz	100-300 Hz	300-500 Hz
16	3		1438				



Hanging clip
for PowerTOP® plugs and connectors

Std. Pack. Qty: 100

Description	Part no.
for 16 A, 3 to 5 p and 32 A, 3 + 4 p	15453000
for 32 A, 5 p	15452000

Plugs and connectors – Connectors

to DIN VDE 0623, EN 60309-2. Other voltages and frequencies available on request. Products with pilot contact available on request.



Hanging connector PowerTOP
with highly heat resistant contact carrier, cable gland and external cable grip, hanging clip

IP 44
Std. Pack. Qty: 10

A	P	110 V	230 V	400 V	500 V	>50 - 500 V	
		50 a. 60 Hz	50 a. 60 Hz	50 a. 60 Hz	50 a. 60 Hz	100-300 Hz	300-500 Hz
16	5			3778			
32	5			3999			



Connector PowerTOP
with external cable grip and highly heat resistant contact carrier

IP 67
Std. Pack. Qty: 10

A	P	110 V	230 V	400 V	500 V	>50 - 500 V	
		50 a. 60 Hz	50 a. 60 Hz	50 a. 60 Hz	50 a. 60 Hz	100-300 Hz	300-500 Hz
16	3	3859	3860	3862			
16	4	3869	3873	3871	3872		
16	5	3879	3883	3881			
32	3	3887	3888	3891			
32	4	3896	3899	3897	3898		
32	5	3905	3909	3907			



Connector AM-TOP
single part body, cable gland and sealing, strain relief and protection against kinking

IP 67
Std. Pack. Qty: 10

A	P	110 V	230 V	400 V	500 V	>50 - 500 V	
		50 a. 60 Hz	50 a. 60 Hz	50 a. 60 Hz	50 a. 60 Hz	100-300 Hz	300-500 Hz
16	3	539	540	541			
16	4	542	543	544	545	546	547
16	5	548	549	550			
32	3	551	552	553			
32	4	554	555	556	557	558	559
32	5	560	561	562			



Connector PowerTOP® Xtra
X-CONTACT, rubberised grip area, highly heat resistant contact carrier, frame terminals, cable gland and sealing, strain relief and protection against kinking

IP 67
Std. Pack. Qty: 5

A	P	110 V	230 V	400 V	500 V	>50 - 500 V	
		50 a. 60 Hz	50 a. 60 Hz	50 a. 60 Hz	50 a. 60 Hz	100-300 Hz	300-500 Hz
63	3	14201	14202	14203			
63	4	14204	14205	14206	14207	14208	14209
63	5	14210	14211	14212	14213		14214
125	3	14215	14216				
125	4	14217	14218	14219	14220		
125	5	14223	14224	14225	14226		14227



Vidéo :
X-CONTACT

X-CONTACT
INSIDE



Get more information on the new generation of contact sleeves:
on page 28 or at
www.x-contact.info



Success in series.

A new approach to combination units. Extensively configurable combination units in six different sizes – the AMAXX® range by MENNEKES. With an appealing and unique design in many variations for almost all applications.

The AMAXX® combination with five segments completes the program. We also feature largescale combinations with all known AMAXX® advantages.

With the suspendable combination units, MENNEKES rounds out the unique versatility of the AMAXX® family. The enclosures are fitted with electrical outlets and protective devices from two sides. A chain set is included with each combination. The suspension eyes are integrated in the enclosure and the shape of recesses allows water to run off through the bore of the suspension. A convenient handle at the bottom allows for easy insertion and removal of the plugs. The combinations are available in various designs and can also be equipped with an additional compressed air connection.



4

AMAXX® s is the combination unit for restricted installation in widths and depths. It can be optionally attached on the side or swivel-mounted.

The smallest AMAXX® combination with one segment rounds off the program. It is available in protection type IP 44 and IP 67 as well as from 16 A, 3-pole up to 32 A, 5-pole and as AMAXX® DUO switched and interlocked.



The space-saver AMAXX® s

AMAXX® s is the optimum solution for restricted spaces. Besides mounting on the rear, you can also mount it on the right or the left thanks to the optionally available attachment set. Or you opt for the variant that can be swivelled by 90 degrees on the left or the right for even more comfortable application.



AMAXX® combination units by MENNEKES combine energy and data in one product family and have been highly successful for many years.

MENNEKES offers the right combination for each requirement: from the smallest AMAXX® combination unit with one segment, through the largest with five segments to the suspended combination unit. Fully configurable in six different enclosure dimensions and as always in an attractive design. AMAXX® by MENNEKES provides the electrician with almost infinite combination possibilities.

Variety of versions.

- Protection type: IP 44 and IP 67.
- Enclosure made of high-quality plastic or AMELAN in aggressive atmospheres with high resistance to chemicals as well as highly heat resistant contact carrier and nickel plated contacts.
- Colours: bottom part black, top part grey (silver (IP 44) or yellow available on request).
- Equipped with: CEE sockets from 16 A, 3 p up to 63 A, 5 p, grounding-type sockets in acc. with many national standards, DUO sockets switched and interlocked from 16 A, 3 p up to 32 A, 5 p as well as fuse elements.



4

You can rely on it.

MENNEKES quality: tested and certified.

Like all other MENNEKES combinations, the AMAXX® products are also subject to the extensive MENNEKES quality control. Each AMAXX® combination is thoroughly tested and certified prior to delivery.

<h1>ZERTIFIKAT</h1> <p>CERTIFICATE</p> <p>für stückgeprüfte Qualität nach DIN EN 61439.</p> <p>for individually tested quality according to IEC 61439.</p>	 <p>MENNEKES MY POWER CONNECTION</p>
<p>Hiermit bestätigen wir, dass diese Steckdosen-Kombination einer Stückprüfung unterzogen wurde. Herewith we confirm that this receptacle combination has passed a routine test.</p> <p>Der MENNEKES-Sicherheitstest berücksichtigt nicht nur die elektrischen Prüfanforderungen nach DIN EN 61439, sondern beinhaltet darüber hinaus auch eine allpolige Hochspannungsprüfung. The MENNEKES safety test not just include the requirements for electrical tests acc. to IEC 61439 but also a high voltage test for all poles.</p>	
 Dietmar Löcker Bereichsleiter Qualität / Division Manager Quality	
<p>MENNEKES Elektrotechnik GmbH & Co. KG Alloys-Mennekes-Straße 1 57399 KIRCHHUNDEIM / GERMANY</p>	<p>Phone: +49 2723 41-1 Fax: +49 2723 41-214 www.MENNEKES.de</p>



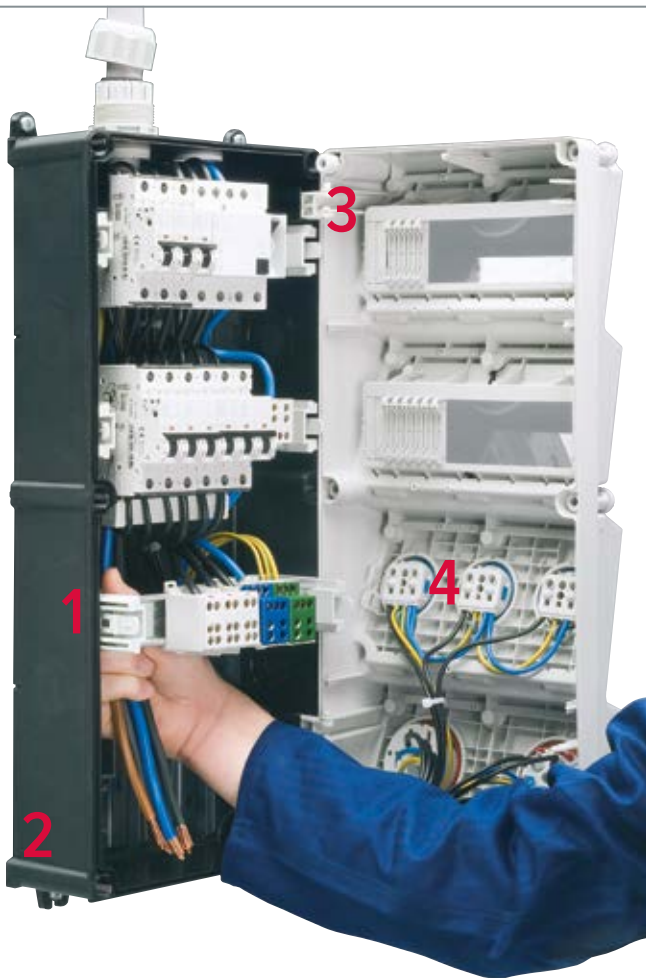

Sophisticated details.

- 1 **Liftable DIN rails.**
Liftable DIN rails and a large, smooth wiring space significantly ease the insertion as well as connection of large cables.
- 2 **One-man installation.**
Shorter installation times with the new, user-friendly external fixing.
- 3 **Hinged cover.**
The hinged cover, which opens to one side, eases connection work.
- 4 **Ready for application.**
All combinations are pre-wired for installation and tested for electric safety and quality.



- Generally angled insertion direction, also with sockets SCHUKO®



- Both hands free because inspection windows fold downwards



- Especially fast opening and closing of the enclosure due to captive double-threaded cover screws



- Window can be locked with a padlock, enclosure can be sealed

Standard for low voltage switchgear and control gear assemblies - IEC 61439.

The standard IEC 61439 replaces IEC 60439 and describes the design and test specifications for low voltage switchgear and control gear assemblies. The new standard has implications for the distribution of electrical energy in industry, domestic electrical installations and on construction sites.

In the future two main standards will be required for each design of a low voltage switchgear and control gear assembly:

- the basic standard that is referenced as „Part 1“ in the specific standards;
- the applicable parts 2 to 7 of the switchgear and control gear assembly standard that deals with the particularities of the application.

The demands imposed on combination units that must be classified as a switchgear and control gear assembly have changed. Structure and manner of verification have been redefined.

In the Service tab on pages 98 to 101 you will find additional information, excerpts from the standard for low voltage switchgear and control gear assemblies - IEC 61439, and a listing of the agreements between manufacturers of the switchgear and control gear assemblies and users.

What has changed with the switchgear standard – IEC 61439 and what are the benefits for the MENNEKES customer?

• Product safety

In the future, all low voltage switchgear and control gear assemblies must be tested in accordance with IEC 61439. The requirement of design verification is new. Design verification replaces the type test. MENNEKES combination units are subjected to additional standard-compliant routine tests. The outgoing circuits are individually loaded with the respective rated current.

Your advantage: This guarantees an even higher standard of safety.

• Clear documentation

Significant rating plate – clearly defined mandatory information, such as rated diversity factor RDF (previously: simultaneity factor).

Your advantage: The main technical product information is visible on the rating plate at a glance.

• Clear specifications

Requests for a custom solution require clearly defined specifications by the user (such as installation site, ambient temperatures, etc.). Your advantage: You get a need-based solution by MENNEKES tailored to the specific application.

• Distinction:

Original manufacturer manufacturer If a product is modified on site, the company in question is considered to be the manufacturer. In this case a new verification and documentation are required from this company.

Your advantage: For combination units that are prewired for installation, MENNEKES is the original manufacturer and manufacturer and therefore bears the complete product responsibility.

Example – rating plate

I_{nA} Rated current of the switchgear and control gear assembly

U_n Rated voltage

f_n Rated frequency



RDF Rated diversity factor

I_{cc} Conditional rated short-circuit current

Protection class

IP Ingress protection

Combination units – Wall mounted, AMAXX®

Pre-wired for installation (except part no. 910214 and 910394), IP 44, enclosure front cover electric grey RAL 7035, hinged to the side (except enclosure size 130 x 225 mm and 650 x 112.5 mm). Fusing behind a transparent cover. For drawings and dimensions see page 111 - 112.

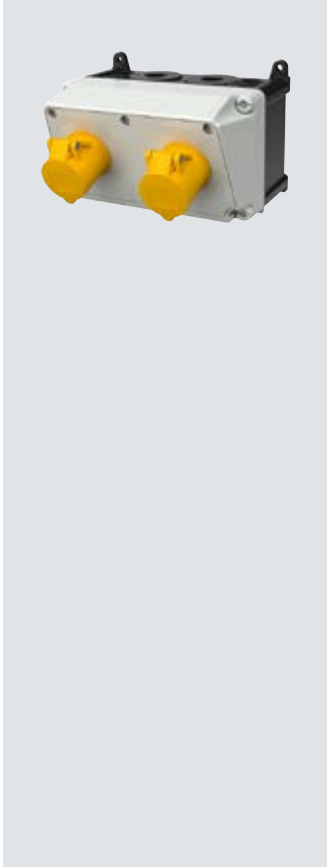
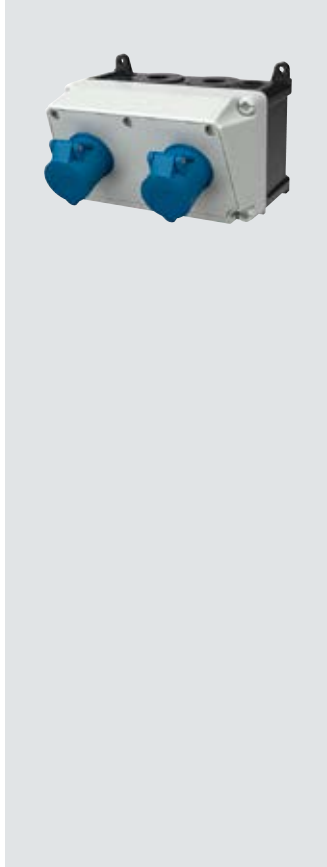
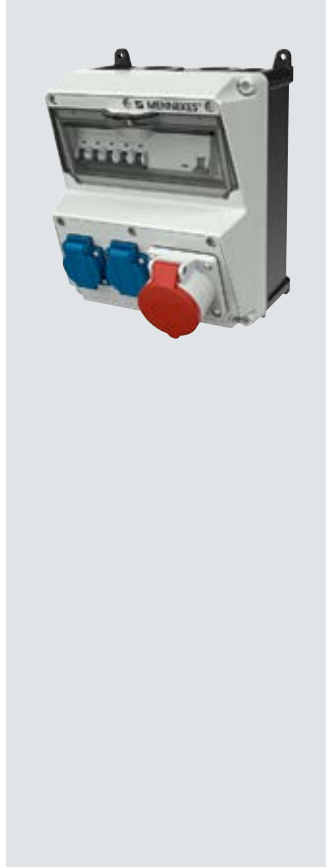
			
CEE sockets	CEE sockets	CEE sockets	CEE sockets
	2 CEE 16 A, 3 p, 110 V		1 CEE 16 A, 5 p, 400 V
CEE sockets	CEE sockets	CEE sockets	CEE sockets
		2 CEE 16 A, 3 p, 230 V	
Sockets British standard	Sockets British standard	Sockets British standard	Sockets British standard
3 x 13 A, 2 p+E, 230 V			2 x 13 A, 2 p+E, 230 V
Fusing	Fusing	Fusing	Fusing
1 RCD 40 A, 4 p, 0.03 A 3 MCB's 13 A, 1 p, C			1 RCD 40 A, 4 p, 0.03 A 1 MCB 16 A, 3 p, C 2 MCB's 13 A, 1 p, C
Connection	Connection	Connection	Connection
For 1 cable up to 5 x 10 mm ²	For 2 cables up to 3 x 4 mm ²	For 2 cables up to 3 x 4 mm ²	For 1 cable up to 5 x 10 mm ²
Connection and load values	Connection and load values	Connection and load values	Connection and load values
Pre-fuse max. 63 A InA 39 A RDF 1			Pre-fuse max. 63 A InA 28 A RDF 0.95
Enclosure size	Enclosure size	Enclosure size	Enclosure size
260 x 225 mm (H x W)	130 x 225 mm (H x W)	130 x 225 mm (H x W)	260 x 225 mm (H x W)
Part no.	Part no.	Part no.	Part no.
921015	910214	910394	920286

Combination units – Wall mounted, AMAXX®

Pre-wired for installation, IP 44, enclosure front cover electric grey RAL 7035, hinged to the side (except enclosure size 130 x 225 mm and 650 x 112.5 mm). Fusing behind a transparent cover. For drawings and dimensions see page 111 - 112.

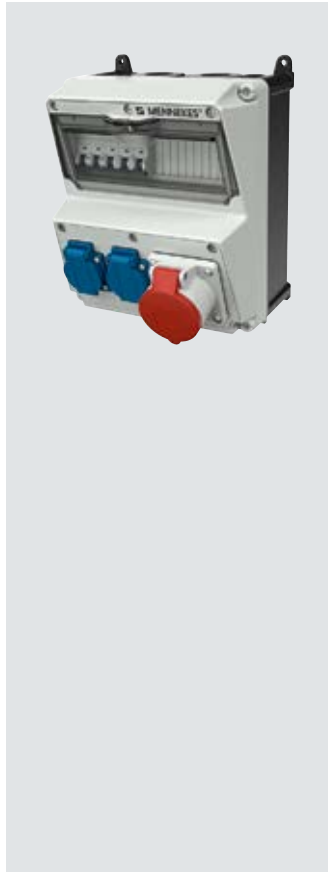

CEE sockets

1 CEE 16 A, 5 p, 400 V

CEE sockets

Sockets British standard

2 x 13 A, 2 p+E, 230 V

Fusing

1 MCB 16 A, 3 p, C
2 MCB's 13 A, 1 p, C

Connection

For 1 cable up to 5 x 10 mm²

Connection and load values

Pre-fuse max. 63 A
InA 29 A
RDF 1

Enclosure size

260 x 225 mm (H x W)

Part no.

920464



CEE sockets

2 CEE 16 A, 5 p, 400 V
Sockets, switched, with
mechanical DUO-interlock

CEE sockets

Sockets British standard

Fusing

2 MCB's 16 A, 3 p, C

Connection

For 1 cable up to 5 x 10 mm²

Connection and load values

Pre-fuse max. 100 A
InA 32 A
RDF 1

Enclosure size

390 x 225 mm (H x W)

Part no.

931227



CEE sockets

1 CEE 16 A, 5 p, 400 V

CEE sockets

Sockets British standard

2 x 13 A, 2 p+E, 230 V

Fusing

1 RCD 40 A, 4 p, 0.03 A
1 MCB 16 A, 3 p, C
1 MCB 13 A, 1 p, C

Connection

For 1 cable up to 5 x 10 mm²

Connection and load values

Pre-fuse max. 63 A
InA 29 A
RDF 1

Enclosure size

650 x 112.5 mm (H x W)

Part no.

960043



CEE sockets

2 CEE 16 A, 5 p, 400 V

CEE sockets

Sockets British standard

Fusing

1 RCD 40 A, 4 p, 0.03 A
1 MCB 16 A, 3 p, C

Connection

For 1 cable up to 5 x 10 mm²

Connection and load values

Pre-fuse max. 63 A
InA 16 A
RDF 1

Enclosure size



260 x 225 mm (H x W)

Part no.

920860

Combination units – Wall mounted, AMAXX®



Pre-wired for installation, IP 44, enclosure front cover electric grey RAL 7035, hinged to the side (except enclosure size 130 x 225 mm and 650 x 112.5 mm). Fusing behind a transparent cover. For drawings and dimensions see page 111 - 112.

		
<p>CEE sockets 2 CEE 16 A, 5 p, 400 V</p>	<p>CEE sockets 1 CEE 32 A, 5 p, 400 V 1 CEE 16 A, 5 p, 400 V</p>	<p>CEE sockets 1 CEE 63 A, 5 p, 400 V 1 CEE 32 A, 5 p, 400 V 1 CEE 16 A, 5 p, 400 V</p>
<p>CEE sockets</p>	<p>CEE sockets</p>	<p>CEE sockets</p>
<p>Sockets British standard</p>	<p>Sockets British standard 2 x 13 A, 2 p+E, 230 V</p>	<p>Sockets British standard 2 x 13 A, 2 p+E, 230 V</p>
<p>Fusing 2 RCD's 40 A, 4 p, 0.03 A</p>	<p>Fusing 1 RCD 40 A, 4 p, 0.03 A 1 MCB 32 A, 3 p, C 1 MCB 16 A, 3 p, C 2 MCB's 13 A, 1 p, C</p>	<p>Fusing 1 RCD 63 A, 4 p, 0.03 A 1 MCB 32 A, 3 p, C 1 MCB 16 A, 3 p, C 2 MCB's 13 A, 1 p, C</p>
<p>Connection For 1 cable up to 5 x 10 mm²</p>	<p>Connection For 1 cable up to 5 x 16 mm²</p>	<p>Connection For 1 cable up to 5 x 16 mm²</p>
<p>Connection and load values Pre-fuse max. 16 A InA 16 A RDF 1</p>	<p>Connection and load values Pre-fuse max. 40 A InA 40 A RDF 0.85</p>	<p>Connection and load values Pre-fuse max. 63 A InA 63 A RDF 0.65</p>
<p>Enclosure size 260 x 225 mm (H x W)</p>	<p>Enclosure size 390 x 225 mm (H x W)</p>	<p>Enclosure size 520 x 225 mm (H x W)</p>
<p>Part no. 920851</p>	<p>Part no. 931234</p>	<p>Part no. 941137</p>

Combination units – Wall mounted, AMAXX®

Pre-wired for installation, IP 67, enclosure front cover electric grey RAL 7035, hinged to the side (except enclosure size 130 x 225 mm and 650 x 112.5 mm). Fusing behind a transparent cover. For drawings and dimensions see page 111 - 112.

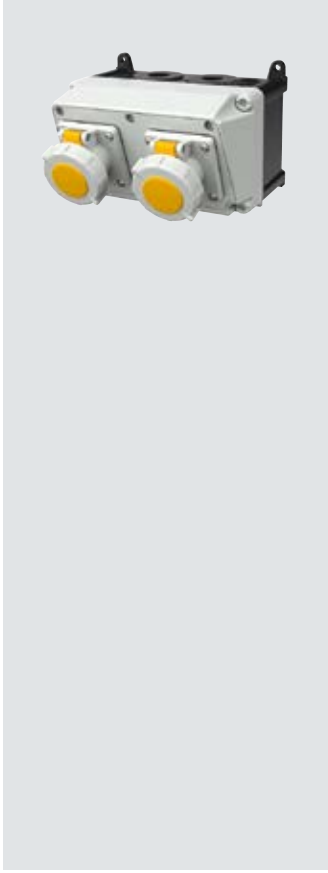
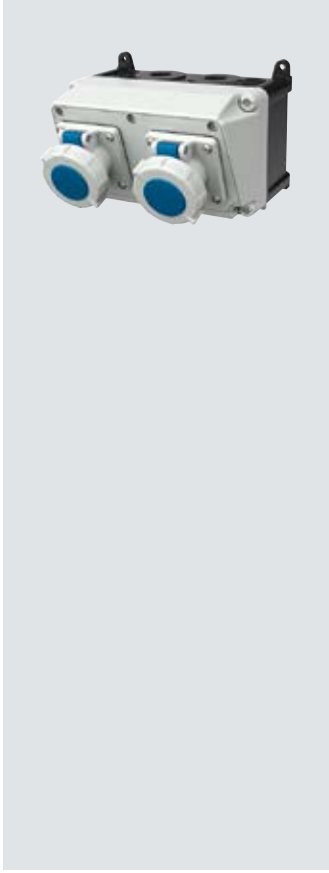
4

			
CEE sockets 2 CEE 16 A, 3 p, 110 V	CEE sockets	CEE sockets 2 CEE 16 A, 3 p, 110 V	CEE sockets
CEE sockets	CEE sockets 2 CEE 16 A, 3 p, 230 V	CEE sockets	CEE sockets 2 CEE 16 A, 3 p, 230 V
Sockets British standard	Sockets British standard	Sockets British standard	Sockets British standard
Fusing	Fusing	Fusing 1 RCD 25 A, 2 p, 0.03 A	Fusing 1 RCD 25 A, 2 p, 0.03 A 1 MCB 16 A, 1 p, C
Connection For 2 cables up to 3 x 6 mm ²	Connection For 1 cable up to 3 x 10 mm ²	Connection For 1 cable up to 3 x 10 mm ²	Connection For 1 cable up to 3 x 10 mm ²
Connection and load values	Connection and load values	Connection and load values Pre-fuse max. 16 A InA 25 A RDF 1	Connection and load values Pre-fuse max. 63 A InA 16 A RDF 1
Enclosure size 130 x 225 mm (H x W)	Enclosure size 130 x 225 mm (H x W)	Enclosure size 260 x 225 mm (H x W)	Enclosure size 260 x 225 mm (H x W)
Part no. 910393	Part no. 910355	Part no. 920700	Part no. 920714

Combination units – Wall mounted, AMAXX®

Pre-wired for installation, IP 67, enclosure front cover electric grey RAL 7035, hinged to the side (except enclosure size 130 x 225 mm and 650 x 112.5 mm). Fusing behind a transparent cover. For drawings and dimensions see page 111 - 112.



CEE sockets

CEE sockets

2 CEE 16 A, 3 p, 230 V

Sockets British standard

Fusing

1 RCD 25 A, 2 p, 0.03 A

Connection

For 1 cable up to 3 x 10 mm²

Connection and load values

Pre-fuse max. 16 A
InA 25 A
RDF 1

Enclosure size

260 x 225 mm (H x W)

Part no.

920649



CEE sockets

2 CEE 32 A, 5 p, 400 V
Sockets, switched, with
mechanical DUO-interlock
2 CEE 16 A, 5 p, 400 V

CEE sockets

Sockets British standard

Fusing

1 RCD 63 A, 4 p, 0.03 A
2 MCB's 32 A, 3 p, C
1 MCB 16 A, 3 p, C

Connection

For 1 cable up to 5 x 16 mm²

Connection and load values

Pre-fuse max. 63 A
InA 58 A
RDF 0.6

Enclosure size

260 x 225 mm (H x W)

Part no.

900946

Combination units – Accessories, wall mounted

Accessories for AMAXX® combination units.



AMAXX® standard cable glands

black RAL 9005

M 20 - for cable from 6-13 mm
IP 44: **Part no. 990607**
IP 67: **Part no. 990611**

M 25 - for cable from 9-17 mm
IP 44: **Part no. 990610**

M 32 - for cable from 13-21 mm
IP 44: **Part no. 990608**
IP 67: **Part no. 990612**

M 40 - for cable from 14-28 mm
IP 67: **Part no. 990609**



AMAXX® screw set

consisting of
4 screws 6 x 70 mm
Pozidrive size 3, steel
galvanized and
4 dowels 8 x 50 mm, for
concrete, porous concrete, solid
brick, perforated brick

Part no. 990606



AMAXX® attachment set

for lateral installation
of AMAXX® s combinations, for
mounting either on the left or
right hand side
(set of 2 for 1 combination)

Part no. 990620



AMAXX® support/carrier frame

yellow RAL 1003,
suitable for AMAXX®
combination units
with the sizes:
260 x 225 mm,
390 x 225 mm and
520 x 225 mm
for wall mounting in
protection type IP 67 or as
mobile combinations with
carrying handle and with
feeder cable in protection
type IP 44 and IP 67

Part no. 15696

4



AMAXX® membrane cable glands

black RAL 9005,
incl. blanking plug

M 25 - for cable from 9-17 mm
Part no. 990623

M 32 - for cable from 13-21 mm
Part no. 990625

M 40 - for cable from 16-28 mm
Part no. 990627

Selection chart for membrane cable glands

AMAXX® combination units	Standard cable entries	Recommndation of usage membrane cable gland*	
with 1 segment Enclosure: 130 x 225 mm (H x W)	top: 2 x M 25 2 x M 20 bottom: 2 x M 25 2 x M 20	1 x M 25	alternative: 1 x M 20
with 2 segments Enclosure: 230 x 225 mm (H x W)	top: 2 x M 32 2 x M 20 bottom: 2 x M 32 2 x M 20	1 x M 32	alternative: 2 x M 20
with 3 segments Enclosure: 390 x 225 mm (H x W)	top: 2 x M 40 2 x M 20 bottom: 2 x M 40 2 x M 20	1 x M 40	alternative: 2 x M 20
with 4 segments Enclosure: 520 x 225 mm (H x W)	top: 2 x M 40 2 x M 20 bottom: 2 x M 40 2 x M 20	1 x M 40 und 1 x M 20	alternative: 3 x M 20
with 5 segments Enclosure: 650 x 225 mm (H x W)	top: 2 x M 40 2 x M 20 bottom: 2 x M 40 2 x M 20	1 x M 40 und 2 x M 20	alternative: 4 x M 20

* At least required for the following ambient conditions:

Reduction of the ambient temperature by 45 °C through 10-minutes of heavy rain (enclosure, e.g heated to 60 °C through sunlight, subsequent cloudburst with water temperature of 15 °C).

If temperature differentials are greater/less, accordingly more or fewer membrane cable glands must be used.

Combination units – Wall mounted, AMAXX®

Highly resistant to chemicals made of AMELAN, pre-wired for installation, IP 44 and IP 67, enclosure front cover grey RAL 7000, hinged to the side (except enclosure size 130 x 225 mm and 650 x 112.5 mm). Fusing behind a transparent cover. For drawings and dimensions see page 111 -112.



CEE sockets 1 CEE 32 A, 5 p, 400 V 1 CEE 16 A, 5 p, 400 V	CEE sockets	CEE sockets	CEE sockets 1 CEE 32 A, 5 p, 400 V
CEE sockets	CEE sockets 2 CEE 16 A, 3 p, 230 V	CEE sockets 1 CEE 32 A, 3 p, 230 V	CEE sockets
Sockets British standard 3 x 13 A, 2 p+E, 230 V	Sockets British standard	Sockets British standard	Sockets British standard
Fusing 1 RCD 63 A, 4 p, 0.03 A 1 MCB 32 A, 3 p, C 1 MCB 16 A, 3 p, C 3 MCB's 13 A, 1 p, C	Fusing 1 RCD 25 A, 2 p, 0.03 A	Fusing 1 RCD 40 A, 2 p, 0.03 A	Fusing 1 RCD 40 A, 4 p, 0.03 A
Connection For 1 cable up to 5 x 16 mm ²	Connection For 1 cable up to 3 x 10 mm ²	Connection For 1 cable up to 3 x 10 mm ²	Connection For 1 cable up to 5 x 10 mm ²
Connection and load values Pre-fuse max. 63 A InA 63 A RDF 0.75	Connection and load values Pre-fuse max. 63 A InA 63 A RDF 0.75	Connection and load values	Connection and load values Pre-fuse max. 32 A InA 63 A RDF 0.75
Enclosure size 520 x 225 mm (H x W)	Enclosure size 260 x 225 mm (H x W)	Enclosure size 260 x 225 mm (H x W)	Enclosure size 260 x 225 mm (H x W)
Part no. 941142	Part no. 920821	Part no. 921022	Part no. 921024

Combination units – Suspended, AMAXX®

Pre-wired for installation, IP 44, enclosure front cover electric grey, yellow or silver, hinged to the side. Fusing behind a transparent cover. With suspension eyes on top, grip hooks on the bottom and chain set provided.

* The combination units can be ordered in electric grey RAL 7035, yellow RAL 1021 or silver RAL 9006. To order in yellow or silver, please add the appropriate colour code to the order number (yellow = GE, silver = SI).
For drawings and dimensions see page 111.



4

Set of chains

are provided with each suspendable AMAXX® combination unit.



CEE sockets

2 CEE 16 A, 5 p, 400 V

CEE sockets

Sockets SCHUKO®

4 SCHUKO® 16 A, 230 V

Fusing

1 RCD 40 A, 4 p, 0.03 A
2 MCB's 16 A, 3 p, C
4 MCB's 16 A, 1 p, C

Connection

For 1 cable up to 5 x 10 mm²

Connection and load values

Pre-fuse max. 40 A
InA 40 A
RDF 0.7

Enclosure size

260 x 225 mm (H x W)

Part no.

970004*



CEE sockets

1 CEE 32 A, 5 p, 400 V
1 CEE 16 A, 5 p, 400 V

CEE sockets

Sockets SCHUKO®

3 SCHUKO® 16 A, 230 V

Fusing

1 RCD 40 A, 4 p, 0.03 A
1 MCB 16 A, 3 p, C
3 MCB's 16 A, 1 p, C

Connection

For 1 cable up to 5 x 10 mm²

Connection and load values

Pre-fuse max. 32 A
InA 32 A
RDF 1

Enclosure size

260 x 225 mm (H x W)

Part no.

970002*

Combination units – Suspended, AMAXX®

Pre-wired for installation, IP 44, enclosure front cover electric grey, yellow or silver, hinged to the side. Fusing behind a transparent cover. With suspension eyes on top, grip hooks on the bottom and chain set provided.

* The combination units can be ordered in electric grey RAL 7035, yellow RAL 1021 or silver RAL 9006. To order in yellow or silver, please add the appropriate colour code to the order number (yellow = GE, silver = SI).
For drawings and dimensions see page 111.



Pneumatic connection

for suspendable AMAXX®

for tube NW 9 mm,
Part no. 997001

for tube NW 13 mm,
Part no. 997000

CEE sockets

1 CEE 32 A, 5 p, 400 V
1 CEE 16 A, 5 p, 400 V

Data port sockets

1 Cepex RJ45, 2 fold Cat.6

Sockets SCHUKO®

3 SCHUKO® 16 A, 230 V

Fusing

1 RCD 40 A, 4 p, 0.03 A
1 MCB 16 A, 3 p, C
3 MCB's 16 A, 1 p, C

Connection

For 1 cable up to 5 x 10 mm²

Connection and load values

Pre-fuse max. 32 A
InA 32 A
RDF 1

Enclosure size

260 x 225 mm (H x W)

Part no.

970005*

CEE sockets

1 CEE 32 A, 5 p, 400 V
1 CEE 16 A, 5 p, 400 V

CEE sockets

Sockets SCHUKO®

4 SCHUKO® 16 A, 230 V

Fusing

1 RCD 40 A, 4 p, 0.03 A
1 MCB 32 A, 3 p, C
1 MCB 16 A, 3 p, C
4 MCB's 16 A, 1 p, C

Connection

For 1 cable up to 5 x 10 mm²

Connection and load values

Pre-fuse max. 40 A
InA 40 A
RDF 0.7

Enclosure size

260 x 225 mm (H x W)

Part no.

970001*

CEE sockets

1 CEE 32 A, 5 p, 400 V
1 CEE 16 A, 5 p, 400 V

CEE sockets

Sockets SCHUKO®

4 SCHUKO® 16 A, 230 V

Fusing

1 MCB 32 A, 3 p, C
1 MCB 16 A, 3 p, C
4 MCB's 16 A, 1 p, C

Connection

For 1 cable up to 5 x 10 mm²

Connection and load values

Pre-fuse max. 63 A
InA 63 A
RDF 0.85

Enclosure size

260 x 225 mm (H x W)

Part no.

970003*

AirKRAFT and 3KRAFT

The Team for electrical power. Data. Compressed air.

For ceiling and floor.

You need electrical power, compressed air, data? Safe and flexible?

Go for AirKRAFT or 3KRAFT. Characteristic for both: Suspended from the ceiling, attached to the wall, or portable with a supply cable, also available in signal yellow, red or silver. The choice is yours!



Up to four sockets plus compressed air. Pre-wired for installation or operation, with a supply cable and plug.



Awards

AirKRAFT and 3KRAFT have been awarded with many design prizes among the famous reddot award.



DESIGNPREIS 2006
DESIGNPREIS DER
BUNDESREPUBLIK
DEUTSCHLAND
NOMINIERT

DESIGN PLUS
Award 2004



reddot award
product design

Bronzemedaille 2004

Deutscher Designer Club



4

DELTA-BOX the classic unit.

With cable grip. Each DELTA-BOX comes with a suspension bracket. Available in IP 44, IP 67 and IP 68.





Socket strips the versatile units.

Suspendable, portable or for wall mounting. Pre-wired for installation. With cable gland. Available in IP 44.



Combination units – AirKRAFT and 3KRAFT

Pre-wired for installation, IP 20 or IP 44¹⁾ ¹⁾ Regarding portable combination units in IP 44 please see page 106 for further information.
 Fusing behind a transparent cover. Colours: Back box in black, cover available in red (RO), yellow (GE) or silver (SI). Other variations on request.
 Dimensions page 113

			
Fitted with 1 CEE 16 A, 5 p, 400 V 3 SCHUKO® 16 A, 230 V	Fitted with 2 CEE 16 A, 5 p, 400 V 2 SCHUKO® 16 A, 230 V	Fitted with 2 CEE 16 A, 5 p, 400 V 2 SCHUKO® 16 A, 230 V	Fitted with 1 CEE 16 A, 5 p, 400 V 3 SCHUKO® 16 A, 230 V
Fusing	Fusing	Fusing 1 RCD 40 A, 4 p, 0.03 A	Fusing 1 MCB 16 A, 3 p, C 1 MCB 16 A, 1 p, C
Connection For 1 cable up to 5 x 10 mm ²	Connection For 1 cable up to 5 x 10 mm ²	Connection For 1 cable up to 5 x 10 mm ²	Connection 3 m H07RN-F5G4 with CEE plug 32 A, 5 p, 400 V
Connection and load values	Connection and load values	Connection and load values	Connection and load values
Protection type IP 44	Protection type IP 44	Protection type IP 44	Protection type IP 44
Part no. 94550	Part no. 94552	Part no. 94553	Part no. 94559
			
Fitted with 3 SCHUKO® 16 A, 230 V	Fitted with 2 SCHUKO® 16 A, 230 V 1 RJ45 double data port cat.6, 8/8	Fitted with 1 CEE 16 A, 5 p, 400 V 1 SCHUKO® 16 A, 230 V 1 RJ45 double data port cat.6, 8/8	Fitted with 3 SCHUKO® 16 A, 230 V
Fusing	Fusing	Fusing	Fusing
Connection For 1 cable up to 3 x 6 mm ²	Connection For 1 cable up to 3 x 6 mm ²	Connection For 1 cable up to 5 x 10 mm ²	Connection 3 m H07RN-F3G1.5 with plug SCHUKO® 16 A, 230 V
Connection and load values	Connection and load values	Connection and load values	Connection and load values
Protection type IP 44	Protection type IP 20	Protection type IP 20	Protection type IP 44
Part no. 94351	Part no. 94354	Part no. 94355	Part no. 94357

Combination units – DELTA-BOX

Pre-wired for installation, IP 44¹⁾ / 67 ¹⁾ Regarding portable combination units in IP 44 please see page 106 for further information.
With cable grip and installed hanging hook. Other combinations on request. Dimensions page 113.



Fitted with
3 CEE 16 A, 5 p, 400 V

Fusing

Connection
For 1 cable up to 5 x 10 mm²

Connection and load values

Protection type
IP 44

Part no.
92917



Fitted with
3 CEE 32 A, 5 p, 400 V

Fusing

Connection
For 1 cable up to 5 x 10 mm²

Caractéristiques électriques

Protection type
IP 44

Part no.
90839

4



Fitted with
1 CEE 16 A, 5 p, 400 V
3 SCHUKO® 16 A, 230 V

Fusing
1 Inter. différentiel
25 A, 2 p, 0,03 A

Connection
For 1 cable up to 5 x 10 mm²

Connection and load values

Protection type
IP 44

Part no.
92658



Fitted with
2 CEE 16 A, 5 p, 400 V
1 CEE 16 A, 5 p, 400 V

Fusing

Connection
For 1 cable up to 5 x 10 mm²









Connection and load values

Protection type
IP 44

Part no.
92893

Combination units – Socket strips

Pre-wired for installation, IP 44¹⁾ / 67 ¹⁾Regarding portable combination units in IP 44 please see page 97 for further information.
Other combinations on request. For drawings and dimensions see page 113.

			
Fitted with 3 Grounding type sockets British standard 13 A, 2 p+E, 230 V	Fitted with 3 CEE 16 A, 3 p, 110 V	Fitted with 3 CEE 16 A, 3 p, 230 V	Fitted with 3 CEE 16 A, 5 p, 400 V
Fusing 1 RCD 0.03 A	Fusing 1 RCD 0.03 A	Fusing 1 RCD 0.03 A	Fusing 1 RCD 0.03 A
Connection For 1 cable up to 3 x 10 mm ²	Connection For 1 cable up to 3 x 10 mm ²	Connection For 1 cable up to 3 x 10 mm ²	Connection For 1 cable up to 5 x 10 mm ²
Connection and load values	Connection and load values	Connection and load values	Connection and load values
Protection type IP 44	Protection type IP 44	Protection type IP 44	Protection type IP 44
Part no. 52005	Part no. 52001	Part no. 52003	Part no. 95472
			
Fitted with 2 CEE 16 A, 5 p, 400 V 1 SCHUKO® 16 A, 230 V	Fitted with 3 CEE 16 A, 3 p, 110 V	Fitted with 3 CEE 16 A, 3 p, 230 V	Fitted with 3 CEE 16 A, 5 p, 400 V
Fusing	Fusing	Fusing	Fusing
Connection For 1 cable up to 5 x 10 mm ²	Connection For 1 cable up to 3 x 10 mm ²	Connection For 1 cable up to 3 x 10 mm ²	Connection For 1 cable up to 5 x 10 mm ²
Connection and load values	Connection and load values	Connection and load values	Connection and load values
Protection type IP 44	Protection type IP 44	Protection type IP 44	Protection type IP 44
Part no. 96703	Part no. 96227	Part no. 96489	Part no. 96705

EverGUM

Flexible safety.



With the EverGUM range MENNEKES provide a solid rubber alternative to enclosures in plastics and sheet steel. This is an alternative which is suitable for the most diverse environments, especially when there is likely to be exposure to rough handling or aggressive cleaning agents. These products can also be supplied to conform to the standards of other European countries.

The outstanding advantages:

- Resistant to weather and ageing
- High dimensional stability and precision
- Good resistance to acids and alkalis
- High dielectric strength and creep resistance

The allround power-packages for mobile use in industry, craft and trade. They can accept quite a knock – neither their design nor their function will be impaired. Additional benefit: they are stackable which allows space-saving storage.

Tested safety, EverGUM details.

The closed lower side of the enclosure with a ground clearance of 77 mm prevents ingress of water. The panel mounted sockets can be replaced from outside. Hinged cover provided with stainless steel quick release clips. MCB's and in RCD's are immediately accessible after opening the lid. All energised parts even with the lid open are covered so that they are contact safe – in accordance with BGV A3. Screw or padlock offers additional safety.







Socket strip EverGUM.

Window size for six or eight modules for vertical installation.



Combination units – EverGUM

Pre-wired for installation, IP 44¹⁾ ¹⁾ Regarding portable combination units in IP 44 please see page 104 for further information.
 Fusing behind a transparent cover. Colour: signal yellow. Other variations with CEE sockets 3, 4 or 5 pole and with grounding-type sockets of French/Belgian, British, Swiss and US-standards on request. Dimensions page 113 - 114.

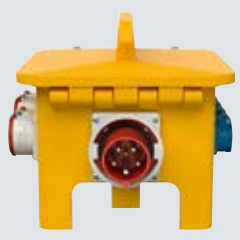
			
Fitted with 1 CEE 32 A, 5 p, 400 V 1 CEE 16 A, 5 p, 400 V 3 SCHUKO® 16 A, 230 V	Fitted with 1 CEE 63 A, 5 p, 400 V 1 CEE 32 A, 5 p, 400 V 1 CEE 16 A, 5 p, 400 V 4 SCHUKO® 16 A, 230 V	Fitted with 3 CEE 16 A, 5 p, 400 V	Fitted with 1 CEE 16 A, 5 p, 400 V 2 SCHUKO® 16 A, 230 V
Fusing 1 MCB 32 A, 3 p, C 2 MCB's 16 A, 3 p, C 3 MCB's 16 A, 1 p, B	Fusing 1 MCB 63 A, 3 p, C 1 MCB 32 A, 3 p, C 1 MCB 16 A, 3 p, C 2 MCB's 16 A, 1 p, B	Fusing	Fusing 1 RCD 40 A, 4 p, 0.03 A 2 MCB's 16 A, 1 p, B
Connection for 2 cables up to 5 x 25 mm ²	Connection for 2 cables up to 5 x 25 mm ²	Connection 2 m H07RN-F5G2.5 with CEE-plug 16 A, 5 p, 400 V	Connection 2 m H07RN-F5G2.5 with CEE-plug 16 A, 5 p, 400 V
Connection and load values Pre-fuse max. 100 A InA 48 A RDF 0.75	Connection and load values Pre-fuse max. 63 A InA 63 A RDF 0.85	Connection and load values	Connection and load values InA 16 A RDF 0.95
Protection type IP 44	Protection type IP 44	Protection type IP 44	Protection type IP 44
Part no. 70007	Part no. 71062	Part no. 70029	Part no. 70033
			
Fitted with 2 CEE 16 A, 5 p, 400 V 4 SCHUKO® 16 A, 230 V	Fitted with 1 CEE 32 A, 5 p, 400 V 1 CEE 16 A, 5 p, 400 V 4 SCHUKO® 16 A, 230 V	Fitted with 1 CEE 63 A, 5 p, 400 V 1 CEE 32 A, 5 p, 400 V 1 CEE 16 A, 5 p, 400 V 4 SCHUKO® 16 A, 230 V	Fitted with 1 CEE 63 A, 5 p, 400 V 1 CEE 32 A, 5 p, 400 V 1 CEE 16 A, 5 p, 400 V 4 SCHUKO® 16 A, 230 V
Fusing 1 RCD 40 A, 4 p, 0.03 A	Fusing 1 RCD 40 A, 4 p, 0.03 A 1 MCB 16 A, 3 p, C 2 MCB's 16 A, 1 p, B	Fusing 1 RCD 63 A, 4 p, 0.03 A 1 MCB 32 A, 3 p, C 1 MCB 16 A, 3 p, C 2 MCB's 16 A, 1 p, B	Fusing 1 RCD 63 A, 4 p, 0.03 A 1 MCB 32 A, 3 p, C 1 MCB 16 A, 3 p, C 2 MCB's 16 A, 1 p, B
Connection with inlet 16 A, 5 p, 400 V	Connection 2 m H07RN-F5G4 with CEE-plug 32 A, 5 p, 400 V	Connection 3 m H07RN-F5G10 with CEE-plug 63 A, 5 p, 400 V	Connection with inlet 63 A, 5 p, 400 V
Connection and load values InA 16 A RDF 1	Connection and load values InA 32 A RDF 0.65	Connection and load values InA 63 A RDF 0.6	Connection and load values InA 57 A RDF 0.4
Protection type IP 44	Protection type IP 44	Protection type IP 44	Protection type IP 44
Part no. 70350	Part no. 70351	Part no. 70025	Part no. 70049

Combination units – Mobile, EverBOX

Pre-wired for installation, IP 44 or IP 67.

Insulating enclosure IP 67, black (RAL 9005), fusing behind a transparent cover. Other combinations on request.

EverBOX

Mobile distributor for events, fairs, emergency services, heavy industries, markets and funfairs.



The new mobile combination units are available in a variety of assembly fittings. The robust, stackable insulating enclosure are ideally suited for indoor and outdoor use.



Product details

- Robust, watertight insulating enclosure IP 67, black (RAL 9005)
- Acc. to IEC 61439
- Heat resistant -25 °C up to +40 °C
- Resistant to ageing and weather
- Stackable
- Protection of sockets and built-in appliances by stable enclosure frame
- Easy handling with integrated handles
- Flexible fitting options up to 125 A
- Protection against condensation in IP 67
- Fitted with sockets of protection type IP 44 or IP 67
- Fusing behind a transparent cover
- Pre-wired for installation

For customized solutions which are especially made for your applicaton, please contact us!



CEE sockets

- 1 CEE 32 A, 5 p, 400 V
- 2 CEE 16 A, 5 p, 400 V

CEE sockets

Sockets SCHUKO®

- 6 SCHUKO® 16 A, 230 V

Fusing

- 1 RCD 63 A, 4 p, 0.03 A
- 1 MCB 32 A, 3 p, C
- 2 MCB's 16 A, 3 p, C
- 6 MCB's 16 A, 1 p, C

Connection

- 2 m H07RN-F5G10 with CEE-plug 63 A, 5 p, 400 V

Connection and load values

- InA 63 A
- RDF 0.75

Enclosure size

- 560 x 350 x 340 mm (H x W x D)

Protection type

- IP 67

Part no.

- 9500719**

Combination units – Mobile, EverBOX

Pre-wired for installation, IP 44 or IP 67.

Insulating enclosure IP 67, black (RAL 9005), fusing behind a transparent cover. Other combinations on request.

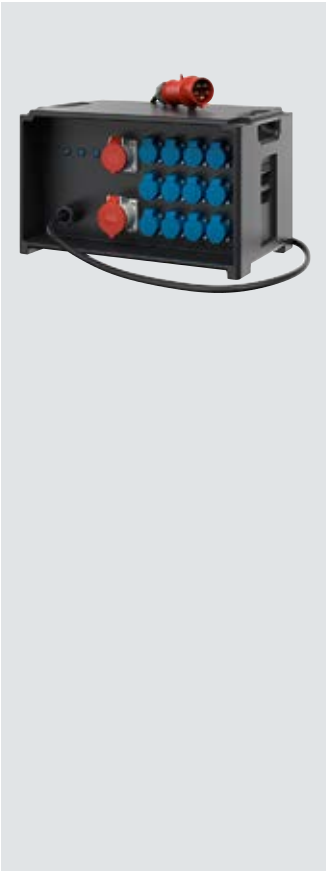
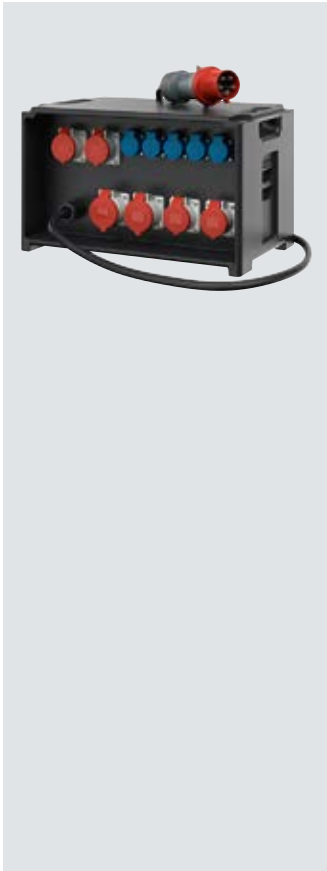
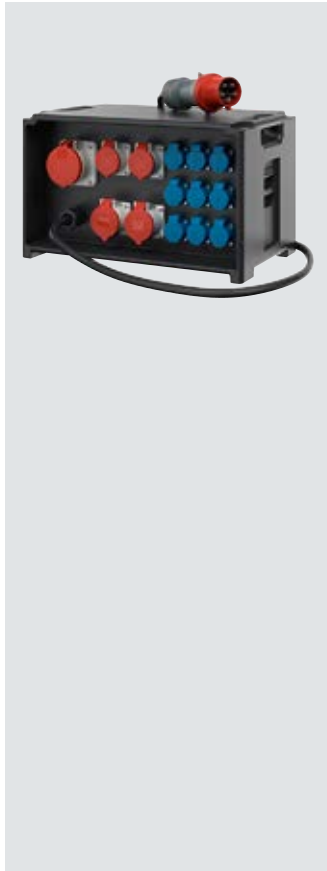
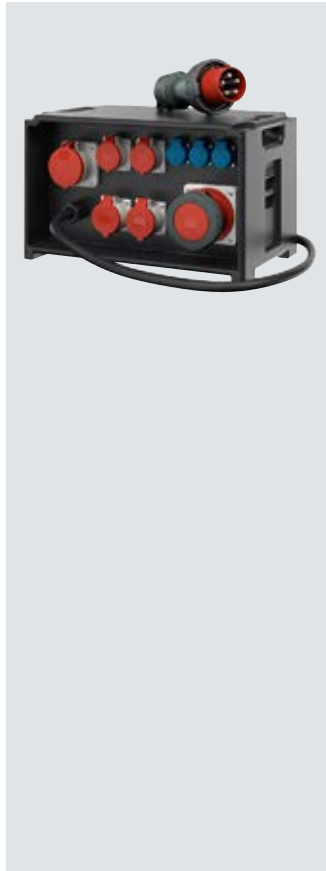
			
CEE sockets	CEE sockets	CEE sockets	CEE sockets
1 CEE 32 A, 5 p, 400 V 1 CEE 16 A, 5 p, 400 V	2 CEE 32 A, 5 p, 400 V 4 CEE 16 A, 5 p, 400 V	1 CEE 63 A, 5 p, 400 V 2 CEE 32 A, 5 p, 400 V 2 CEE 16 A, 5 p, 400 V	1 CEE 125 A, 5 p, 400 V 1 CEE 63 A, 5 p, 400 V 2 CEE 32 A, 5 p, 400 V 2 CEE 16 A, 5 p, 400 V
CEE sockets	CEE sockets	CEE sockets	CEE sockets
Sockets SCHUKO®	Sockets SCHUKO®	Sockets SCHUKO®	Sockets SCHUKO®
12 SCHUKO® 16 A, 230 V	5 SCHUKO® 16 A, 230 V	9 SCHUKO® 16 A, 230 V	3 SCHUKO® 16 A, 230 V
Fusing	Fusing	Fusing	Fusing
1 RCD 40 A, 4 p, 0.03 A 1 MCB 16 A, 3 p, C, 10 kA 12 MCB's 16 A, 1 p, C, 10 kA 3 Phase control lights green	2 RCD's 63 A, 4 p, 0.03 A 2 MCB's 32 A, 3 p, C 4 MCB's 16 A, 3 p, C 5 MCB's 16 A, 1 p, C	1 RCD 63 A, 4 p, 0.03 A 2 MCB's 32 A, 3 p, C 2 MCB's 16 A, 3 p, C 9 MCB's 16 A, 1 p, C	2 RCD's 63 A, 4 p, 0.03 A 2 MCB's 63 A, 3 p, C 2 MCB's 32 A, 3 p, C 2 MCB's 16 A, 3 p, C 3 MCB's 16 A, 1 p, C
Connection	Connection	Connection	Connection
2 m H07RN-F5G6 with CEE-plug 32 A, 5 p, 400 V	2 m H07RN-F5G10 with CEE-plug 63 A, 5 p, 400 V	2 m H07RN-F5G10 with CEE-plug 63 A, 5 p, 400 V	2 m H07RN-F5G25 with CEE-plug 125 A, 5 p, 400 V
Connection and load values	Connection and load values	Connection and load values	Connection and load values
InA 32 A RDF 1	InA 63 A RDF 0.75	InA 63 A RDF 0.6	InA 125 A RDF 0.35
Enclosure size	Enclosure size	Enclosure size	Enclosure size
560 x 350 x 340 mm (H x W x D)	560 x 350 x 340 mm (H x W x D)	560 x 350 x 340 mm (H x W x D)	560 x 350 x 340 mm (H x W x D)
Protection type	Protection type	Protection type	Protection type
IP 44	IP 44	IP 44	IP 44
Part no.	Part no.	Part no.	Part no.
9500722	9500706	9500748	9500417



Stainless steel surface mounted and flush mounted combination units.

Safe. Practical. Timelessly elegant.

- Protection type IP 43 or IP 44 with closed door, even when plugs are inserted
- The cable guard aperture is sufficiently dimensioned for leading through cables
- Safety lock protects against unauthorised access



CombiTOWER Outdoors and indoors.

Short routes to your energy source for industry, workshops, assembly shops, loading platforms, etc.

4



Power posts Rugged. Vandalism-proof.

Steel power posts provide a safe means of energy supply, protection against car-crossing. Hot-dip galvanised and powder coated. Available in various sizes.

Combination units – Stainless steel

Stainless steel enclosure (material 1.4301). Surface with a flat finish (K240), material 1.4571 on request.
Protection type IP 44 (combination unit for wall fixing) or IP 43 (flush mounted combination unit) with closed door.
For drawings and dimensions see page 114.



Title
Combination unit, wall fixing
Fitted with
1 CEE socket 16 A, 5 p, 400 V 4 sockets British standard 13 A, 2 p+E, 230 V
Fusing:
1 RCD 40 A, 4 p, 0.03 A 1 MCB 16 A, 3 p, C 4 MCB's 16 A, 1 p, B
Enclosure:
standard door with stop on right, front door with swing handle and cylinder lock – lockable even when plugs are connected. Cable entry / connection options: 2 x entry nipples M 32 on bottom, 2 x brass screw plugs M 16 on bottom, terminal shock hazard protected to BGV A3
Connection:
for 2 cables up to 5 x 25 mm ²
Enclosure size
530 x 400 x 220 mm (H x W x D)
Part no.
6212980

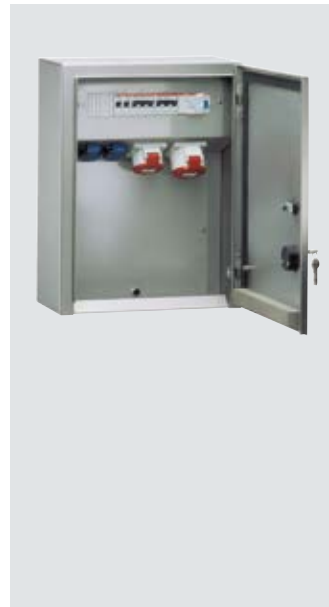

Title
Combination unit, wall fixing
Fitted with
1 CEE socket 32 A, 5 p, 400 V 1 CEE socket 16 A, 5 p, 400 V 2 sockets British standard 13 A, 2 p+E, 230 V
Fusing:
1 RCD 63 A, 4 p, 0.03 A 1 MCB 32 A, 3 p, C 1 MCB 16 A, 3 p, C 2 MCB's 16 A, 1 p, B
Enclosure:
standard door with stop on right, front door with swing handle and cylinder lock – lockable even when plugs are connected. Cable entry / connection options: 2 x entry nipples M 32 on bottom, 2 x brass screw plugs M 16 on bottom, terminal shock hazard protected to BGV A3
Connection:
for 2 cables up to 5 x 25 mm ²
Connection and load values:
Pre-fuse max. 63 A I _{nA} 46 A RDF 0.75
Enclosure size
530 x 400 x 220 mm (H x W x D)
Part no.
6212993



Title
Combination unit, flush mounted
Fitted with
1 CEE socket 16 A, 5 p, 400 V 4 sockets British standard 13 A, 2 p+E, 230 V
Fusing:
1 RCD 40 A, 4 p, 0.03 A 1 MCB 16 A, 3 p, C 4 MCB's 16 A, 1 p, B
Enclosure:
front door and trim frame (from flat finished stainless steel): lockable with cylinder, lockable even when plugs are connected, door stop on the right flush mounted enclosure (from stainless steel): cable entry bush 3 x top, 2 x bottom, suitable for cable diameters 13 to 49 mm
Connection:
for 2 cables up to 5 x 25 mm ²
Front door and trim frame:
580 x 420 mm (H x W)
Enclosure size
520 x 360 x 200 mm (H x W x D)
Part no.
6103180



Title
Combination unit, flush mounted
Fitted with
1 CEE socket 32 A, 5 p, 400 V 1 CEE socket 16 A, 5 p, 400 V 2 sockets British standard 13 A, 2 p+E, 230 V
Fusing:
1 RCD 63 A, 4 p, 0.03 A 2 MCB's 16 A, 1 p, B
Enclosure:
front door and trim frame (from flat finished stainless steel): lockable with cylinder, lockable even when plugs are connected, door stop on the right flush mounted enclosure (from stainless steel): cable entry bush 3 x top, 2 x bottom, suitable for cable diameters 13 to 49 mm
Connection:
for 2 cables up to 5 x 25 mm ²
Front door and trim frame:
580 x 420 mm (H x W)
Enclosure size
520 x 360 x 200 mm (H x W x D)
Part no.
6103196

Combination units – Steel

Power posts from steel tube. Sockets IP 44 or IP 67 can be fitted.
For drawings and dimensions see page 114 -115.



Title
Power post
Fitted with
1 CEE socket 16 A, 5 p, 400 V 2 sockets British standard 13 A, 2 p+E, 230 V
Fusing: 1 MCB 16 A, 3 p, C 1 MCB 16 A, 1 p, B
Enclosure: Wall thickness 4.0 mm, hot-dip galvanised, powder coated, colour: red, hinged supply aperture with safety lock, weight: approx. 45 kg Aperture at bottom: (H x W) 50 x 40 mm. Fixing flange: Ø 360 mm with 4 fixing holes 15.0 mm. For fixing to an existing fundament.
Cable entry: 2 x M 25 open at the top
Connection: for 1 cable up to 5 x 6 mm ²
Connection and load values: Pre-fuse max. 63 A InA 22 A RDF 0.7
Enclosure size
1050 x 220 mm (H x Ø, inside)
Part no.
6308078



Title
Power post
Fitted with
1 CEE socket 32 A, 5 p, 400 V 1 CEE socket 16 A, 5 p, 400 V 2 sockets British standard 13 A, 2 p+E, 230 V
Fusing: 1 RCD 40 A, 4 p, 0.03 A 1 MCB 32 A, 3 p, C 1 MCB 16 A, 3 p, C 2 MCB's 16 A, 1 p, B
Enclosure: Wall thickness 4.5 mm, electro galvanised, yellow chromated and powder coated, colour: anthracite (RAL 7016), hinged supply aperture with safety lock, weight: approx. 60 kg Aperture at bottom: (H x W) 60 x 70 mm. Fixing flange: Ø 390 mm with 4 fixing holes 15.5 mm. For fixing to an existing fundament.
Cable entry: 2 x M 32 open at the top, 1 x M 32 plugged at the top
Connection: for 1 cable up to 5 x 10 mm ²
Connection and load values: Pre-fuse max. 40 A InA 40 A RDF 0.75
Enclosure size
1050 x 273 mm (H x Ø, inside)
Part no.
6308081

Combination units – Stainless steel

CombiTOWER from stainless steel (material 1.4301), material 1.4571 on request.
For drawings and dimensions see page 114 -115.



Title
CombiTOWER
Fitted with
with removable cover, painted signal yellow (RAL 1003) or bright finish.
Part no. for AMAXX® enclosures 260 x 225 mm, 390 x 225 mm and 520 x 225 mm
* Part no. for AMAXX® enclosures 650 x 225 mm
Enclosure size
1043 x 254.5 x 250 mm (H x W x D)
Part no.
15679 / * 15739 yellow 15678 / * 15738 bright finish



Title
CombiTOWER
Fitted with
with lockable door and removable cover, painted signal yellow (RAL 1003) or bright finish
Part no. for AMAXX® enclosures 260 x 225 mm, 390 x 225 mm and 520 x 225 mm
* Part no. for AMAXX® enclosures 650 x 225 mm
Enclosure size
1043 x 254 x 415 mm (H x W x D)
Part no.
15681 / * 15741 yellow 15680 / * 15740 bright finish

SCHUKO®

Plugs and sockets for harsh conditions.

SCHUKO® by MENNEKES with the hammer symbol.

Acc. to VDE 0105 part 115. Made of high-grade plastic. Acc. to VDE 0620 for harsh conditions. Application amongst others in agriculture or at construction sites. Resistant against oil, grease and fuel. Long lasting due to high resistance against abrasion and breaking strength. Durable due to resistance against embrittlement.

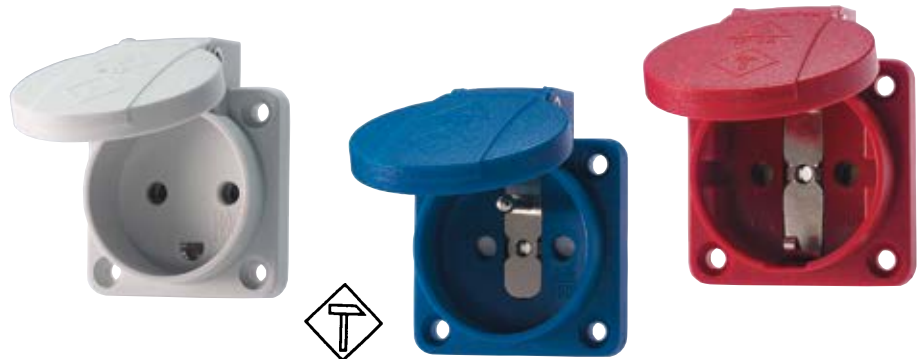

Panel mounted sockets SCHUKO® with front gasket for portable units.

The attachment sockets SCHUKO® with sealing collars, from MENNEKES comply with the requirements in the new standard, IEC 620-1.

With the hinged lid closed, they satisfy the requirements for the IP 54 degree of protection in every position.

Even with the compatible IP 44 plug, plugged-in, the IP 44 protection rating is ensured regardless of the operating position



Product advantages:

- retention of the installation dimensions and conditions
- conversion without problems
- flange sealing made of thermoplastic elastomer (TPE)
- captive due to two components technology
- safe against accidental actuation with a finger or the back of the hand according to IEC 60529
- optionally screw or plug-in terminals
- with hammer symbol for toughest conditions
- also available with flange dimensions 75 x 75 mm for cable ducts and flush mounted boxes

SCHUKO®. Pressure watertight.

Whether fixed or mobile: in the event of flooding or water jets, pressure watertight plugs and sockets are the first choice. Protection type IP 68.





Special plugs and sockets – SCHUKO® and grounding-type

SCHUKO® to DIN 49440-1, 2 p+E, 230 V. Other versions available on request. For drawings and dimensions see page 102 - 110.

 <p>Panel mounted socket SCHUKO® with hinged lid, 3 plug-in terminals or 3 screw terminals as connecting terminals for 1.5 - 2.5 mm²</p> <p>IP 54 Std. Pack. Qty: 100/20 Drawing: 1 MB 410</p>	Colour	Ampere	Voltage	with shutter	plug-in terminals	screw terminals
	grey	16	230		11010	11030
	blue	16	230		11011	11031
	black	16	230		11012	11032
	red	16	230		11013	11033
	grey	16	230	✓	11060	
	blue	16	230	✓	11061	11081

 <p>Panel mounted socket SCHUKO® with front gasket with hinged lid, 3 plug-in terminals or 3 screw terminals as connecting terminals for 1.5 - 2.5 mm²</p> <p>IP 54 Std. Pack. Qty: 100 Drawing: 1 MB 586</p>	Colour	Ampere	Voltage	with shutter	plug-in terminals	screw terminals
	grey	16	230		11310	11330
	blue	16	230		11311	11331
	black	16	230		11312	11332
	red	16	230		11313	11333

 <p>Panel mounted socket SCHUKO® without hinged lid, 3 plug-in terminals or 3 screw terminals as connecting terminals for 1.5 - 2.5 mm²</p> <p>IP 20 Std. Pack. Qty: 100 Drawing: 1 MB 450</p>	Colour	Ampere	Voltage	with shutter	plug-in terminals	screw terminals
	blue	16	230		11511	11531
	black	16	230		11512	11532
	blue	16	230	✓	11561	11581







 <p>Wall mounted socket SCHUKO® with hinged lid, 3 plug-in terminals as connecting terminals for 1.5 - 2.5 mm², sockets can be linked in a row vertically. Slide on top, slot on bottom of enclosure</p> <p>IP 44 Std. Pack. Qty: 10 Drawing: 1 MB 27/30</p>	Colour	Ampere	Voltage	with shutter	plug-in terminals	screw terminals
	grey	16	230		10081	
	blue	16	230		10082	
	black	16	230		10083	

 <p>Wall mounted socket grounding-type French/Belgian system (NF) with hinged lid, 3 plug-in terminals as connecting terminals for 1.5 - 2.5 mm², sockets can be linked in a row vertically. Slide on top, slot on bottom of enclosure</p> <p>IP 44 Std. Pack. Qty: 10 Drawing: 1 MB 27/30</p>	Colour	Ampere	Voltage	with shutter	plug-in terminals	screw terminals
	blue	16	230	✓	10092	

 <p>Panel mounted socket grounding-type French/Belgian system (NF), with hinged lid, 3 plug-in terminals or 3 screw terminals as connecting terminals for 1.5 - 2.5 mm²</p> <p>IP 44 Std. Pack. Qty: 10 Drawing: 1 MB 410</p>	Colour	Ampere	Voltage	with shutter	plug-in terminals	screw terminals
	grey	16	230		11110	
	blue	16	230		11111	11131
	grey	16	230	✓	11160	11180
	blue	16	230	✓	11161	11181
	black	16	230	✓	11162	11182

Special plugs and sockets – SCHUKO® and grounding-type

SCHUKO® to DIN 49440-1, 2 p+E, 230 V. Other versions available on request. For drawings and dimensions see page 102 - 110.

	Panel mounted socket grounding-type French/Belgian system (NF), without hinged lid, 3 plug-in terminals or 3 screw terminals as connecting terminals for 1.5 - 2.5 mm ²	<table border="1"> <thead> <tr> <th>Colour</th> <th>Ampere</th> <th>Voltage</th> <th>with shutter</th> <th>plug-in terminals</th> <th>screw terminals</th> </tr> </thead> <tbody> <tr> <td>blue</td> <td>16</td> <td>230</td> <td>✓</td> <td>11611</td> <td></td> </tr> <tr> <td>blue</td> <td>16</td> <td>230</td> <td></td> <td>11661</td> <td>11681</td> </tr> </tbody> </table>	Colour	Ampere	Voltage	with shutter	plug-in terminals	screw terminals	blue	16	230	✓	11611		blue	16	230		11661	11681														
	Colour	Ampere	Voltage	with shutter	plug-in terminals	screw terminals																												
	blue	16	230	✓	11611																													
blue	16	230		11661	11681																													
IP 20 Std. Pack. Qty: 100/20 Drawing: 1 MB 450																																		
	Panel mounted socket grounding-type British standard, with hinged lid and seal; flange 50 x 50 mm, fixing holes 38 x 38 mm	<table border="1"> <thead> <tr> <th>Colour</th> <th>Ampere</th> <th>Voltage</th> <th>with shutter</th> <th>plug-in terminals</th> <th>screw terminals</th> </tr> </thead> <tbody> <tr> <td>blue</td> <td>13</td> <td>230</td> <td>✓</td> <td></td> <td>10718</td> </tr> </tbody> </table>	Colour	Ampere	Voltage	with shutter	plug-in terminals	screw terminals	blue	13	230	✓		10718																				
	Colour	Ampere	Voltage	with shutter	plug-in terminals	screw terminals																												
	blue	13	230	✓		10718																												
IP 44 Std. Pack. Qty: 20 Drawing: 1 MB 584																																		
	Panel mounted socket grounding-type British standard, matching cover frame, with hinged lid and seal	<table border="1"> <thead> <tr> <th>Colour</th> <th>Ampere</th> <th>Voltage</th> <th>with shutter</th> <th>plug-in terminals</th> <th>screw terminals</th> </tr> </thead> <tbody> <tr> <td>black</td> <td>13</td> <td>230</td> <td>✓</td> <td></td> <td>10713</td> </tr> </tbody> </table>	Colour	Ampere	Voltage	with shutter	plug-in terminals	screw terminals	black	13	230	✓		10713																				
	Colour	Ampere	Voltage	with shutter	plug-in terminals	screw terminals																												
	black	13	230	✓		10713																												
IP 44 Std. Pack. Qty: 20 Drawing: 1 MB 422																																		
	Panel mounted socket NEMA USA and Canada, with hinged lid	<table border="1"> <thead> <tr> <th>Colour</th> <th>Ampere</th> <th>Voltage</th> <th>with shutter</th> <th>plug-in terminals</th> <th>screw terminals</th> </tr> </thead> <tbody> <tr> <td>blu</td> <td>15</td> <td>125</td> <td></td> <td></td> <td>10087</td> </tr> </tbody> </table>	Colour	Ampere	Voltage	with shutter	plug-in terminals	screw terminals	blu	15	125			10087																				
	Colour	Ampere	Voltage	with shutter	plug-in terminals	screw terminals																												
	blu	15	125			10087																												
IP 44 Std. Pack. Qty: 20 Drawing: 1 MB 421																																		
	Plug SCHUKO® with combined PE-conductor acc. to German and French/Belgian standards, with grommet, for cables up to 3 x 2.5 mm ² up to H07RN-F	<table border="1"> <thead> <tr> <th>Colour</th> <th>Ampere</th> <th>Voltage</th> <th>Part no.</th> </tr> </thead> <tbody> <tr> <td>grey</td> <td>16</td> <td>230</td> <td>10749</td> </tr> <tr> <td>black</td> <td>16</td> <td>230</td> <td>10754</td> </tr> <tr> <td>orange</td> <td>16</td> <td>230</td> <td>10837</td> </tr> <tr> <td>blue</td> <td>16</td> <td>230</td> <td>10838</td> </tr> <tr> <td>red</td> <td>16</td> <td>230</td> <td>10839</td> </tr> <tr> <td>yellow</td> <td>16</td> <td>230</td> <td>10840</td> </tr> <tr> <td>green</td> <td>16</td> <td>230</td> <td>10841</td> </tr> </tbody> </table>	Colour	Ampere	Voltage	Part no.	grey	16	230	10749	black	16	230	10754	orange	16	230	10837	blue	16	230	10838	red	16	230	10839	yellow	16	230	10840	green	16	230	10841
	Colour	Ampere	Voltage	Part no.																														
	grey	16	230	10749																														
	black	16	230	10754																														
	orange	16	230	10837																														
	blue	16	230	10838																														
	red	16	230	10839																														
	yellow	16	230	10840																														
green	16	230	10841																															
IP 44 Std. Pack. Qty: 20																																		
	Connector SCHUKO® with grommet and lid for cables up to 3 x 2.5 mm ² up to H07RN-F	<table border="1"> <thead> <tr> <th>Colour</th> <th>Ampere</th> <th>Voltage</th> <th>Part no.</th> </tr> </thead> <tbody> <tr> <td>grey</td> <td>16</td> <td>230</td> <td>10751</td> </tr> <tr> <td>black</td> <td>16</td> <td>230</td> <td>10755</td> </tr> <tr> <td>orange</td> <td>16</td> <td>230</td> <td>10842</td> </tr> <tr> <td>blue</td> <td>16</td> <td>230</td> <td>10843</td> </tr> <tr> <td>red</td> <td>16</td> <td>230</td> <td>10844</td> </tr> <tr> <td>yellow</td> <td>16</td> <td>230</td> <td>10845</td> </tr> <tr> <td>green</td> <td>16</td> <td>230</td> <td>10846</td> </tr> </tbody> </table>	Colour	Ampere	Voltage	Part no.	grey	16	230	10751	black	16	230	10755	orange	16	230	10842	blue	16	230	10843	red	16	230	10844	yellow	16	230	10845	green	16	230	10846
	Colour	Ampere	Voltage	Part no.																														
	grey	16	230	10751																														
	black	16	230	10755																														
	orange	16	230	10842																														
	blue	16	230	10843																														
	red	16	230	10844																														
	yellow	16	230	10845																														
green	16	230	10846																															
IP 44 Std. Pack. Qty: 10																																		

Special plugs and sockets – SCHUKO® and grounding-type

to DIN 49442/43 and DIN VDE 0620. Other versions available on request. For drawings and dimensions see page 102 - 110.



Wall mounted socket SCHUKO®
with hinged bayonet lock lid

IP 68
Std. Pack. Qty: 10
Drawing: 1 MB 347

Colour	Ampere	Voltage	with shutter	plug-in terminals	screw terminals
blue / grey	16	230			10863



Panel mounted socket SCHUKO® or NF
with hinged bayonet lock lid, rectangular flange, four fixing holes or two stamped recesses for quick perforation

IP 68
Std. Pack. Qty: 10
Drawing: 1 MB 627

Colour	Ampere	Voltage	with shutter	plug-in terminals	screw terminals
blue / grey	16	230		17002	17006
blue / grey	16	230	✓		17014



Plug SCHUKO®
combined PE-conductor acc. to German and French/Belgian standards, with bayonet ring, with protective cap attached by a strap, for cables up to 3 x 2.5 mm², up to H07RN-F

IP 68
Std. Pack. Qty: 10

Colour	Ampere	Voltage	plug-in terminals	screw terminals
blue / grey	16	230		10828



Connector SCHUKO®
with bayonet lock lid attached by a strap, for cables up to 3 x 2.5 mm², up to H07RN-F

IP 68
Std. Pack. Qty: 10

Colour	Ampere	Voltage	plug-in terminals	screw terminals
blue / grey	16	230		10833

7 pole

For multifunctional applications.



These 7 pole plugs and sockets provide solutions where there are multifunctional requirements in industry, farming and commerce.

This number of poles provides solutions in the following fields:

- Star-delta start-up
- Closed loop control
- Open loop control
- Monitoring
- Detection and alarms
- Clearing alarms
- Electrical interlocking

Position of ground contact tube with respect to polarisation keyway, designated by clockface position for 6 p + \oplus , 16 A and 32 A.

5

Frequency Hz	Rated operating voltage V	Position of ground contact
100 to 300	above 50	10
above 300 to 500	above 50	2
50	110	4
	230	9
	400	6
	500	7
50	220 to 240 downstream from isolating transformer	12

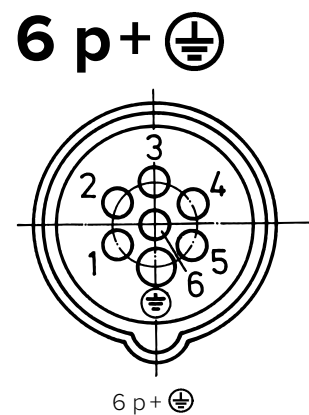

Special plugs and sockets – 7 pole

to DIN VDE 0623-1, EN 60309-1. Colour: electric grey and/or colour code.  Highly resistant to chemicals. Other voltages and frequencies available on request. For drawings and dimensions see page 102 - 110.



Wall mounted socket
with highly heat resistant contact carrier, nickel plated contacts, internal fixing, enclosure base can be turned 180°

IP 44
Std. Pack. Qty: 10
Drawing: 1 MB 43/257

A	P	230 V 50 a. 60 Hz	400 V 50 a. 60 Hz	500 V 50 a. 60 Hz
16	7	733	734	1035
32	7	735	736	1040



Wall mounted socket
highly resistant to chemicals, highly heat resistant contact carrier, nickel plated contacts, 2 external fixings, enclosure can be turned 180°

IP 67
Std. Pack. Qty: 10
Drawing: 1 MB 622

A	P	230 V 50 a. 60 Hz	400 V 50 a. 60 Hz	500 V 50 a. 60 Hz
16	7	9530	9531	9532
32	7	9590	9591	9592



Wall mounted socket
switched, mechanical DUO-interlock, highly heat resistant contact carrier, nickel plated contacts, 6 pole switch with 2 auxiliary contacts (1 NO and 1 NC), sockets can be padlocked

IP 67
Std. Pack. Qty: 1
Drawing: 1 MB 382

A	P	230 V 50 a. 60 Hz	400 V 50 a. 60 Hz	500 V 50 a. 60 Hz
with 6 pole switch:				
16	7		7306	
32	7		7307	



Panel mounted socket
highly heat resistant contact carrier, nickel plated contacts, 20° inclination

IP 44
Std. Pack. Qty: 10
Drawing: 1 MB 260

A	P	230 V 50 a. 60 Hz	400 V 50 a. 60 Hz	500 V 50 a. 60 Hz
16	7	737	738	1045
32	7	739	740	1050



Panel mounted socket
highly heat resistant contact carrier, nickel plated contacts, 20° inclination

IP 67
Std. Pack. Qty: 10
Drawing: 1 MB 251

A	P	230 V 50 a. 60 Hz	400 V 50 a. 60 Hz	500 V 50 a. 60 Hz
16	7	2883	2459	2296
32	7	3775	2317	2212



Plug AM-TOP
highly heat resistant contact carrier, nickel plated contacts, single part body, cable gland and sealing, strain relief and protection against kinking

IP 44
Std. Pack. Qty: 10

A	P	230 V 50 a. 60 Hz	400 V 50 a. 60 Hz	500 V 50 a. 60 Hz
16	7	741	742	1055
32	7	743	744	1060

Special plugs and sockets – 7 pole

to DIN VDE 0623-1, EN 60309-1. Colour: electric grey and/or colour code. Other voltages and frequencies available on request. For drawings and dimensions see page 102 - 110.

 <p>Plug AM-TOP highly heat resistant contact carrier, nickel plated contacts, single part body, cable gland and sealing, strain relief and protection against kinking</p> <p>IP 67 Std. Pack. Qty: 10</p>	A	P	110 V 50 a. 60 Hz	230 V 50 a. 60 Hz	400 V 50 a. 60 Hz	500 V 50 a. 60 Hz	>50 - 500 V 100-300 Hz 300-500 Hz	
	16	7		3776	3777	3913		
	32	7		2405	2324	2213		
 <p>Wall mounted inlet highly heat resistant contact carrier, nickel plated contacts</p> <p>IP 44 Std. Pack. Qty: 10 Drawing: 2 MB 147</p>	A	P	110 V 50 a. 60 Hz	230 V 50 a. 60 Hz	400 V 50 a. 60 Hz	500 V 50 a. 60 Hz	>50 - 500 V 100-300 Hz 300-500 Hz	
	16	7			2166			
	32	7			2167			
 <p>Panel mounted inlet highly heat resistant contact carrier, nickel plated contacts</p> <p>IP 44 Std. Pack. Qty: 10 Drawing: 2 MB 71</p>	A	P	110 V 50 a. 60 Hz	230 V 50 a. 60 Hz	400 V 50 a. 60 Hz	500 V 50 a. 60 Hz	>50 - 500 V 100-300 Hz 300-500 Hz	
	16	7		749	750	1075		
	32	7		751	752	1080		
 <p>Panel mounted inlet highly heat resistant contact carrier, nickel plated contacts, with protective cap</p> <p>IP 67 Std. Pack. Qty: 10 Drawing: 2 MB 203</p>	A	P	110 V 50 a. 60 Hz	230 V 50 a. 60 Hz	400 V 50 a. 60 Hz	500 V 50 a. 60 Hz	>50 - 500 V 100-300 Hz 300-500 Hz	
	16	7		3779	3914	3780		
	32	7		3781	3915	3782		
 <p>Connector AM-TOP with highly heat resistant contact carrier, nickel plated contacts, single part body, cable gland and sealing, strain relief and protection against kinking</p> <p>IP 44 Std. Pack. Qty: 10</p>	A	P	110 V 50 a. 60 Hz	230 V 50 a. 60 Hz	400 V 50 a. 60 Hz	500 V 50 a. 60 Hz	>50 - 500 V 100-300 Hz 300-500 Hz	
	16	7		745	746	1065		
	32	7		747	748	1070		
 <p>Connector AM-TOP highly heat resistant contact carrier, nickel plated contacts, single part body, cable gland and sealing, strain relief and protection against kinking</p> <p>IP 67 Std. Pack. Qty: 10</p>	A	P	110 V 50 a. 60 Hz	230 V 50 a. 60 Hz	400 V 50 a. 60 Hz	500 V 50 a. 60 Hz	>50 - 500 V 100-300 Hz 300-500 Hz	
	16	7		3783	3916	3784		
	32	7		2406	2255	2460		

Special plugs and sockets – For low voltage

to DIN VDE 0623, EN 60309-2. Other voltages and frequencies available on request. For drawings and dimensions see page 102 - 110.

Low voltages.

When portable electric appliances are used in environments where conductive materials are present and where movement is restricted, they must be operated at low voltage or they must be electrically isolated, e.g. in or on boilers, containers, pipework systems, steel scaffolding or similar installations. The same applies to rooms containing exposed conductive materials. Portable lamps must be operated at low voltage.

Stationary appliances may be operated at a safe low voltage or they may be electrically isolated, e.g. lamps installed temporarily for maintenance purposes, cleaning or other types of work, which are connected to the power supply by means of movable cables. Only use tools of protection type II or III. Also, lamps for barrels and movable lamps for ovens must be operated at low voltage.

Furthermore, low voltage 25 V AC should be used for all mobile appliances without insulation which are used on animals, e.g. shears, milking machines, etc.



Requirements on plugs and sockets for low voltages.

Plugs and sockets must be different from those used at other voltages and must not be provided with an earth contact (VDE 0100 part 410:1997-01).

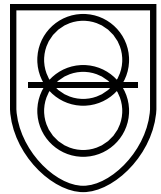

Wall mounted socket

IP 44
Std. Pack. Qty: 10
Drawing: 1 MB 294

A	P	20 - 25 V	40 - 50 V	20 - 25 V 40 - 50 V	20 - 25 V 40 - 50 V
		50 a. 60 Hz	50 a. 60 Hz	100-200 Hz	===
16	2	1825	1831		1829
16	3	1832	1837	1835	
32	2	1838	1844		1842
32	3	1845	1850	1848	





Wall mounted socket

IP 44
Std. Pack. Qty: 10
Drawing: 1 MB 137

A	P	20 - 25 V	40 - 50 V	20 - 25 V 40 - 50 V	20 - 25 V 40 - 50 V
		50 a. 60 Hz	50 a. 60 Hz	100-200 Hz	===
16	2	577	578		583
16	3	584	585	586	
32	2	590	591		596
32	3	597	598	599	

Special plugs and sockets – For low voltage

to DIN VDE 0623, EN 60309-2. Other voltages and frequencies available on request. For drawings and dimensions see page 102 - 110.

 <p>Panel mounted socket flange 55 x 55 mm, straight</p> <p>IP 44 Std. Pack. Qty: 10 Drawing: 1 MB 136</p>	A	P	20 - 25 V 50 a. 60 Hz	40 - 50 V 50 a. 60 Hz	20 - 25 V 40 - 50 V 100-200 Hz	20 - 25 V 40 - 50 V ==
	16	2	603	604		609
	16	3	610	611	612	
	32	2	616	617		622
	32	3	623	624	625	
 <p>Panel mounted socket flange 75 x 75 mm, straight</p> <p>IP 44 Std. Pack. Qty: 10 Drawing: 1 MB 292</p>	A	P	20 - 25 V 50 a. 60 Hz	40 - 50 V 50 a. 60 Hz	20 - 25 V 40 - 50 V 100-200 Hz	20 - 25 V 40 - 50 V ==
	16	2	1602	1603		2617A
	16	3	1657	1661	1823	
	32	2	1693	3290		2488A
	32	3	1594	1595	1579	
 <p>Panel mounted socket flange 68 x 62 mm, 20° inclination</p> <p>IP 44 Std. Pack. Qty: 10 Drawing: 1 MB 231</p>	A	P	20 - 25 V 50 a. 60 Hz	40 - 50 V 50 a. 60 Hz	20 - 25 V 40 - 50 V 100-200 Hz	20 - 25 V 40 - 50 V ==
	16	2	1270	2855		2841
	16	3	2845	1272	2860	
	32	2	1271	2864		2869
	32	3	2870	1273	2852	
 <p>Panel mounted socket 20° inclination</p> <p>IP 44 Std. Pack. Qty: 10 Drawing: 1 MB 236</p>	A	P	20 - 25 V 50 a. 60 Hz	40 - 50 V 50 a. 60 Hz	20 - 25 V 40 - 50 V 100-200 Hz	20 - 25 V 40 - 50 V ==
	32	3			2837	

Special plugs and sockets – For low voltage

to DIN VDE 0623, EN 60309-2. Other voltages and frequencies available on request. For drawings and dimensions see page 102 - 110.

 <p>Plug with cable gland</p> <p>IP 44 Std. Pack. Qty: 10</p>	A	P	20 - 25 V 50 a. 60 Hz	40 - 50 V 50 a. 60 Hz	20 - 25 V 40 - 50 V 100-200 Hz	20 - 25 V 40 - 50 V = = =
	16	2	655A	656A		661A
	16	3	662A	663A	664A	
	32	2	668A	669A		674A
	32	3	675A	676A	677A	

 <p>Wall mounted inlet</p> <p>IP 44 Std. Pack. Qty: 10 Drawing: 2 MB 160</p>	A	P	20 - 25 V 50 a. 60 Hz	40 - 50 V 50 a. 60 Hz	20 - 25 V 40 - 50 V 100-200 Hz	20 - 25 V 40 - 50 V = = =
	16	2	1955	1961		1959
	16	3	1962	1967	1965	
	32	2	1968	1974		1972
	32	3	1975	1980	1978	

 <p>Connector with cable gland</p> <p>IP 44 Std. Pack. Qty: 10</p>	A	P	20 - 25 V 50 a. 60 Hz	40 - 50 V 50 a. 60 Hz	20 - 25 V 40 - 50 V 100-200 Hz	20 - 25 V 40 - 50 V = = =
	16	2	707A	708A		713A
	16	3	714A	715A	716A	
	32	2	720A	721A		726A
	32	3	727A	728A	729A	

200 A - 400 A

Heavy duty versions for industry.

The heavy duty range supplements the plugs and sockets currently covered by EN 60309-2, making available rated currents of 200 A, 250 A and 400 A and rated voltages of up to 1000 V.

Their design is based on the following standards: IEC 309-1, EN 60309-1, DIN VDE 0623, part 1.



Shock hazard protected using contact covers.

Contact bushings on sockets and connectors are fitted with covers which positively prevent getting into contact with live bushings. Shockhazard protected in accordance with IEC 309-1 / EN 60309-1.



Mechanical lock.

For mobile consumers of rated current > 125 A we have included a heavy duty range with 200 A, 250 A and 400 A in our programme. This can be supplied for rated voltages of 230 V to 1000 V and seawater resistant.

The heavy duty range is suitable for use in very harsh conditions, e.g. building sites:

- drilling rigs
- drilling and conveying systems
- tunnel construction
- quarries
- gravel pits
- strip mining
- container terminals and crane connections in harbours
- airports
- for versatile power supply at large-scale indoor and outdoor events
- power supply to market places
- seawater resistant design are available on request



Connection terminals in plugs and sockets 200 A for conductor cross sections of 70 to 150 mm², 250 A and 400 A for conductor cross sections of 70 to 185 mm² or with flexible conductors, and 70 to 240 mm² with single or multiple strand conductors.

Surface protection for contacts.

Contacts 200 A up to 400 A are protected against corrosive atmosphere by silver plating. Contacts (250 A and 400 A) are accessible from the front side so that there is no need to undo the connection cable when exchanging damaged parts.



Plugs, connectors, inlets and wall mounted sockets are supplied with flared bushings for cables of diameter 45 to 65 mm. The outside cable grip facilitates connection.





Two pilot contacts are a standard fitting in all plugs and sockets. The pilot contacts lag when the plug is inserted and lead when it is withdrawn. If required, plugs and sockets can be electrically interlocked.

Special plugs and sockets – 200 A up to 400 A

Design based on IEC 309-1, EN 60309-1, DIN VDE 0623 part 1. Other voltages and frequencies available on request.
For drawings and dimensions see page 102 - 110.

	Wall mounted socket		400 V 50 a. 60 Hz	
	with cable gland, seawater resistant design available on request			
	A	P		
	200	4		75221
	200	5		75226
	250	4		75021
	250	5		75111
IP 67		400	4	75026
Std. Pack. Qty: 1		400	5	75116
200 A Drawing: 1 MB 385				
250 + 400 A Drawing: 1 MB 389/1				

	Wall mounted socket		400 V 50 a. 60 Hz	
	switched, mechanical interlock, seawater resistant design available on request			
	A	P		
	200	4		75231
	200	5		75236
	250	4		75031
	250	5		75121
IP 55		400	4	75036
Std. Pack. Qty: 1		400	5	75126
200 A Drawing: 1 MB 386				
250 + 400 A Drawing: 1 MB 403/2				

	Wall mounted socket		400 V 50 a. 60 Hz	
	switched, electrical interlock, seawater resistant design available on request			
	A	P		
	200	4		75271
	200	5		75276
	250	4		75437
	250	5		75441
IP 55		400	4	75174
Std. Pack. Qty: 1		400	5	75448
200 A Drawing: 1 MB 387				
250 + 400 A Drawing: 1 MB 404/2				

	Panel mounted socket		400 V 50 a. 60 Hz	
	seawater resistant design available on request			
	A	P		
	200	4		75241
	200	5		75246
	250	4		75041
	250	5		75131
IP 67		400	4	75046
Std. Pack. Qty: 1		400	5	75136
200 A Drawing: 1 MB 384				
250 + 400 A Drawing: 1 MB 388/1				

	Panel mounted socket		400 V 50 a. 60 Hz	
	15° inclination, seawater resistant design available on request			
	A	P		
	200	4		75053
	200	5		75058
	250	4		75063
	250	5		75068
IP 67		400	4	75073
Std. Pack. Qty: 1		400	5	75078
200 A Drawing: 1 MB 636				
250 + 400 A Drawing: 1 MB 637				

	Plug		400 V 50 a. 60 Hz	
	with cable gland, seawater resistant design available on request			
	A	P		
	200	4		75201
	200	5		75206
	250	4		75001
	250	5		75091
IP 67		400	4	75006
Std. Pack. Qty: 1		400	5	75096

Special plugs and sockets – 200 A up to 400 A

Design based on IEC 309-1, EN 60309-1, DIN VDE 0623 part 1. Other voltages and frequencies available on request.
For drawings and dimensions see page 102 - 110.

 <p>Inlet with cable gland, seawater resistant design are available on request</p> <p>IP 67 Std. Pack. Qty: 1 200 A Drawing: 2 MB 197 250 + 400 A Drawing: 2 MB 200/1</p>	A	P	400 V 50 a. 60 Hz
	200	4	75251
	200	5	75256
	250	4	75172
	250	5	75173
	400	4	75389
	400	5	75398
 <p>Panel mounted inlet seawater resistant design are available on request</p> <p>IP 67 Std. Pack. Qty: 1 200 A Drawing: 2 MB 196 250 + 400 A Drawing: 2 MB 199/1</p>	A	P	400 V 50 a. 60 Hz
	200	4	75261
	200	5	75266
	250	4	75284
	250	5	75287
	400	4	75291
	400	5	75295
 <p>Panel mounted inlet 15° inclination, seawater resistant design are available on request</p> <p>IP 67 Std. Pack. Qty: 1 200 A Drawing: 2 MB 247 250 + 400 A Drawing: 2 MB 248</p>	A	P	400 V 50 a. 60 Hz
	200	4	75311
	200	5	75316
	250	4	75321
	250	5	75326
	400	4	75331
	400	5	75336
 <p>Connector with cable gland, seawater resistant design are available on request</p> <p>IP 67 Std. Pack. Qty: 1</p>	A	P	400 V 50 a. 60 Hz
	200	4	75211
	200	5	75216
	250	4	75011
	250	5	75101
	400	4	75016
	400	5	75106

Special plugs and sockets – Energy and data

Protection type IP 44.

The right choice for control stations, storage areas, laboratories, airports, production lines, etc. Cepex data port sockets are operated with standard patch cables and can be combined with Cepex sockets CEE and/or SCHUKO®. For wall-/panel mounting or installation in cable ducts.

Cepex data port sockets.



1 The bottom part of the enclosure can be turned by 180 degrees, which allows cable insertion from above or below without additional work.

2 Protection type IP 44 with closed cover or with plug inserted.

3 Suitable for double RJ45 ports, Cat. 3 to Cat. 7 and manufacturer-independent RJ45 Keystones. Openings according to IEC 60603-7.

4 Lockable even with connected cables. The safety lock prevents unauthorized access.

5 Visible labeling field.



Simple:

All types are equipped with a membrane gland fitting M 25 for two cables 3-9 mm. Simply push in the cable – done!



Extra:

A metric cable gland M 25 / 2 x 8 is optionally available.



Title

Compact network distributor

Fitted with

1 Cepex data port socket with 2 RJ45 connection modules, type E-DAT module, port, Cat.6, brand: BTR
2 grounding-type sockets 13 A, 2 p+E, 240 V

Cable entry:

2 M 25 at the top (closed), 1 M 25 at the bottom (with cable gland)
1 M 25 2 x 8 at the bottom (with cable gland seal insert for 2 individual cables up to 8 mm Ø)

Compact network distributor

also available with 4 grounding-type sockets 13 A, 2 p+E, 240 V

Enclosure size: 160 x 245 mm (H x W) (part no. 8310790)

Enclosure size

160 x 245 mm (H x W)

Part no.

8107705



Title

Network enclosure AMAXX®

Fitted with

2 Cepex enclosures (part no.: 4345G) prepared for 4 RJ45 connection modules, type E-DAT module or OpDAT module LC or ST (brand BTR - Not in scope of supply)

Cable entry:

2 x M 25 at the top (closed), 2 x M 25 at the bottom (closed) and 2 x M 20 top and bottom (closed)

Network enclosure AMAXX®

also available with 1 Cepex enclosure (part no.: 25104, 25104GE)

Enclosure size

130 x 225 mm (H x W)

Part no.

25102GE yellow
25102 grey

Special plugs and sockets – Energy and data

Colours: grey (RAL 7035), alpine white (RAL 9010), silver (RAL 9006), black (RAL 9005). For drawings and dimensions see page 102 - 110.



Cepex enclosure, grey
as wall mounted socket, for installation of RJ45 data port sockets, 2 keys, identical lock:
Part no. + Index "G"

IP 44
Std. Pack. Qty: 5
Drawing: 1 MB 313

Brand	Type	Data module	Part no.
AMP	Twist	—	4350 ¹⁾
AMP	Jack	2 x 41457	4360
AMP	CO Plus	—	4370 *
BTR	E-DAT module	2 x 41455	4340 ³⁾
Rutenbeck	iso-8/8 UpOS	1 x 41492	4320
TKM	KDMF	1 x 41452	4300 ¹⁾
Reichle & De-Massari	Module Real 10	2 x 25056	4375 ²⁾



Cepex enclosure, grey
as panel mounted socket, for installation of RJ45 data port sockets, 2 keys, identical lock:
Part no. + Index "G"

IP 44
Std. Pack. Qty: 5
Drawing: 1 MB 305

Brand	Type	Data module	Part no.
AMP	Twist	—	4352 ¹⁾
AMP	Jack	2 x 41457	4362
AMP	CO Plus	—	4372 *
BTR	E-DAT module	2 x 41455	4342 ³⁾
Rutenbeck	iso-8/8 UpOS	1 x 41492	4322
TKM	KDMF	1 x 41452	4302 ¹⁾
Reichle & De-Massari	Module Real 10	2 x 25056	4377 ²⁾



Cepex enclosure, alpine white
as panel mounted socket, for installation of RJ45 data port sockets, 2 keys, identical lock:
Part no. + Index "G"

IP 44
Std. Pack. Qty: 5
Drawing: 1 MB 305

Brand	Type	Data module	Part no.
AMP	Twist	—	4354 ¹⁾
AMP	Jack	2 x 41457	4364
AMP	CO Plus	—	4374 *
BTR	E-DAT module	2 x 41455	4344 ³⁾
Rutenbeck	iso-8/8 UpOS	1 x 41492	4324
TKM	KDMF	1 x 41452	4304 ¹⁾



Cepex enclosure, silver
as panel mounted socket, for installation of RJ45 data port sockets, 2 keys, identical lock:
Part no. + Index "G"

IP 44
Std. Pack. Qty: 5
Drawing: 1 MB 305

Brand	Type	Data module	Part no.
Rutenbeck	iso-8/8 UpOS		4326



Cepex enclosure, black
as panel mounted socket, for installation of RJ45 data port sockets, 2 keys, identical lock:
Part no. + Index "G"

IP 44
Std. Pack. Qty: 5
Drawing: 1 MB 305

Brand	Type	Data module	Part no.
AMP	Twist	—	4366 ¹⁾
AMP	Jack	2 x 41457	4365
AMP	CO Plus	—	4379 *
BTR	Module E-DAT	2 x 41455	4345 ³⁾
Rutenbeck	iso-8/8 UpOS	1 x 41492	4367
Reichle & De-Massari	Module Real 10	2 x 25056	4378 ²⁾

¹⁾ Cepex enclosures also suited for data modules of Telegärtner (AMJ 45 Up/O, cat.6a) and Nexans (LANmark-6 Snap-in Connector with fixing ring Modular Outlet 50).

²⁾ Cepex enclosures also suited for the connection modules Telegärtner (AMJ/UMJ cat.6+, Setec (XKJ), Corning (FutureCOM S10TENE Keystone), Dätwyler (KS-T6A, MS-K, PS-GG45), Rutenbeck (UM real cat.6a, A), LEONI MegaLine, Keystone).

³⁾ Cepex enclosures also suited for LEONI MegaLine.

* The data inserts/modules AMP CO Plus are not part of the MENNEKES delivery program!







Overview of mounting options for RJ45 modules in empty Cepex enclosures.

RJ45 modules and Keystones			Cepex panel mounted socket															Cepex surface-mounted socket																			
Brand	Type	Part no. data module	Part no. enclosure Grey (RAL 7035)							Part no. enclosure Alpine white (RAL 9010)							Part no. enclosure Black (RAL 9005)							Part no. enclosure Silver (RAL 9006)							Part no. enclosure Grey (RAL 7035)						
			4302	4322	4342	4352	4362	4372	4377*	4304	4324	4344	4354	4364	4374	4345	4365	4366	4367	4378*	4379	4326	4300	4320	4340	4350	4360	4370	4375*								
AMP	Jack	41557					●							●			●										●										
AMP	CO Plus							●							●						●							●									
Telegärtner	AMJ 45 Up/O		●			●												●					●				●										
Telegärtner	AMJ/UMJ module								●											●									●								
Nexans	LANmark connector		●			●							●					●					●				●										
BTR	E-DAT module	41455			●							●					●										●										
Rutenbeck	iso-8/8 UPOS	41492		●								●							●					●													
Rutenbeck	UM real								●											●									●								
TKM	KDMF	41452	●								●													●													
Reichle & De-Massari	Module Real 10	25056							●											●									●								
Setec	XKJ								●											●									●								
Corning	FutureCom								●											●									●								
Dätwyler	KS-T6A								●											●									●								
LEONI	MegaLine				●				●			●						●		●							●		●								

* Keystones

Our keystone-variations can be fitted with **supplier independent** modules. Beside RJ45 modules a large variety of electrical and optical connections for data transmission can be fitted.

Special plugs and sockets – Energy and data

	<p>Data module BTR, type: RJ45 connection module 270° (type E-DAT module 8(8) jack cat.6), suitable for Cepex data port sockets, part no. 4340, 4342, 4344, 4355, strain relief per locking clip directly on the stuffer cap</p> <p>Std. Pack. Qty: 20</p>	<table border="1"> <thead> <tr> <th>Part no.</th> </tr> </thead> <tbody> <tr> <td>41455</td> </tr> </tbody> </table>	Part no.	41455
Part no.				
41455				
	<p>Data module AMP, type: RJ45 connection module (type Cat.6 SL Jack), suitable for Cepex data port sockets, part no. 4360 and versions</p> <p>Std. Pack. Qty: 12</p>	<table border="1"> <thead> <tr> <th>Part no.</th> </tr> </thead> <tbody> <tr> <td>41457</td> </tr> </tbody> </table>	Part no.	41457
Part no.				
41457				
	<p>Data module Reichle & De-Massari, type: data port sockets insert Real 10, Cat.6, screened, including frame for snap-in, suitable for Cepex data port sockets, Part no. 4375 and versions</p> <p>Std. Pack. Qty: 10</p>	<table border="1"> <thead> <tr> <th>Part no.</th> </tr> </thead> <tbody> <tr> <td>25056</td> </tr> </tbody> </table>	Part no.	25056
Part no.				
25056				
	<p>Data module Rutenbeck, type: data port insert 2 x RJ45, Cat.6a, (type UPOS), suitable for Cepex data port sockets, Part no. 4320 and versions</p> <p>Std. Pack. Qty: 10</p>	<table border="1"> <thead> <tr> <th>Part no.</th> </tr> </thead> <tbody> <tr> <td>41492</td> </tr> </tbody> </table>	Part no.	41492
Part no.				
41492				
	<p>Data module TKM, type: data port insert 2 x RJ45, Cat.6, (type KDMF), suitable for Cepex data port sockets, Part no. 4300 and versions</p> <p>Std. Pack. Qty: 10</p>	<table border="1"> <thead> <tr> <th>Part no.</th> </tr> </thead> <tbody> <tr> <td>41452</td> </tr> </tbody> </table>	Part no.	41452
Part no.				
41452				
	<p>Data module RJ45 connection module, type E-DAT module, connector 8(8) 90°, Cat.6 (recommended for improved cable routing), for Cepex data port sockets</p> <p>Std. Pack. Qty: 10</p>	<table border="1"> <thead> <tr> <th>Part no.</th> </tr> </thead> <tbody> <tr> <td>25042</td> </tr> </tbody> </table>	Part no.	25042
Part no.				
25042				

Special plugs and sockets – Energy and data

Protection type IP 44.

Pre-wired for installation, enclosure front cover electric grey RAL 7035, yellow (GE) RAL 1021 also available on request. Enclosure hinged to the side.

MENNEKES network distributor.

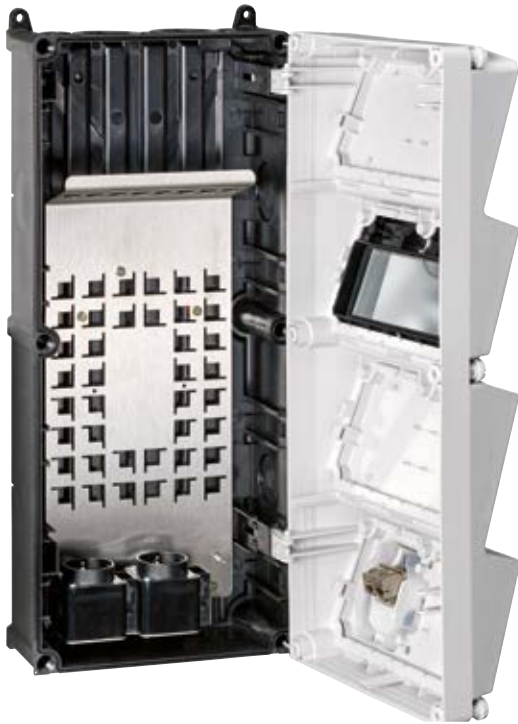

With the new industrial network distributor from the AMAXX® family, MENNEKES offers a product for the expansion of network solutions.

By using a robust plastic enclosure, the installation of standard network components is possible in more demanding environments, such as those that prevail in trade and industry, with regard to protection class, mechanical influences or similar factors.

Existing networks can thus be quickly expanded, while smaller networks can easily be rebuilt. The user can act freely in the selection of active network components and Keystones. Hence the preferred switches or routers can be easily and safely attached to the integrated mounting plate. The patch panel for mounting up to eight Keystones can be equipped with RJ45 sockets or other inserts.

Two SCHUKO® sockets integrated into the enclosure are used for the power supply of the active network components. Another advantage for the user: After the power supply has been connected by the qualified electrician, the further equipping and manipulation of the enclosure can be performed by laymen in the field of electrical technology.



AMAXX® cable gland set

enclosed with each media distributor
Black RAL 9005,
2 screw fittings M 40
2 multiple seals with
6 openings for a cable diameter
of 6-9 mm
including each 5 blind plugs
1 screw fitting M 20

Fitted with

Patch and mounting panel with threaded ground bolt M 6 for the optional connection of an external ground conductor

2 SCHUKO® sockets for the power supply of active network components

1 Cepex data port socket (black RAL 9005) with 2 RJ45 right angle connector modules for direct connection of patch cables

4 Velcro connectors for fastening installed components on the base plate

2 screw fittings M 40 with multiple seal, 6 openings for a cable diameter of 6-9 mm including 5 each blanking plugs

1 screw fitting M 20

1 screw set

Enclosure size

520 x 225 mm (H x W)

Part no.

25405

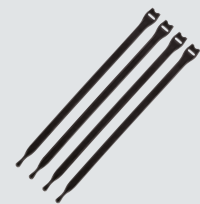

Velcro connector

enclosed with each media distributor
Set of 4 Velcro connectors for fastening installed components on the base plate

Plugs and sockets for reefer containers On ships and in terminals.



AM-TOP plugs and connectors.

Stable enclosure consisting of one part. The teeth on the cable gland secure a safe grip and protect against loosening. The cable gland serves as an anti-bend protection for the cables at the same time.



Wall mounted sockets, switched and interlocked.

Sockets with the patented, mechanical DUO-interlocking ensure that the socket can only be switched when inserting a plug.

Combination units with sockets, switched and interlocked.

380-
440 V

32 A





3 h

3 p+ 

5

Special plugs and sockets – For reefer containers

Ground contact at 3 o'clock position conforming to DIN VDE 0623, EN 60309-2.  Highly resistant to chemicals.
Other versions available on request. For drawings and dimensions see page 102 - 110.

	<p>Wall mounted socket highly resistant to chemicals, with highly heat resistant contact carrier and nickel plated contacts</p> <p>IP 67 Std. Pack. Qty: 10 Drawing: 1 MB 622</p>	<table border="1"> <thead> <tr> <th>A</th> <th>P</th> </tr> </thead> <tbody> <tr> <td>32</td> <td>4</td> </tr> </tbody> </table>	A	P	32	4	<table border="1"> <thead> <tr> <th colspan="2">380 - 440 V 50 a. 60 Hz</th> </tr> </thead> <tbody> <tr> <td colspan="2">9562</td> </tr> </tbody> </table>	380 - 440 V 50 a. 60 Hz		9562	
A	P										
32	4										
380 - 440 V 50 a. 60 Hz											
9562											
	<p>Wall mounted socket with highly heat resistant contact carrier and nickel plated contacts, switched, with mechanical DUO-interlock</p> <p>IP 67 Std. Pack. Qty: 1 Drawing: 1 MB 207</p>	<table border="1"> <thead> <tr> <th>A</th> <th>P</th> </tr> </thead> <tbody> <tr> <td>32</td> <td>4</td> </tr> </tbody> </table>	A	P	32	4	<table border="1"> <thead> <tr> <th colspan="2">380 - 440 V 50 a. 60 Hz</th> </tr> </thead> <tbody> <tr> <td colspan="2">5792A</td> </tr> </tbody> </table>	380 - 440 V 50 a. 60 Hz		5792A	
A	P										
32	4										
380 - 440 V 50 a. 60 Hz											
5792A											
	<p>Wall mounted socket with highly heat resistant contact carrier and nickel plated contacts, switched, with mechanical DUO-interlock and DIN rail</p> <p>IP 67 Std. Pack. Qty: 2 Drawing: 1 MB 181/620</p>	<table border="1"> <thead> <tr> <th>A</th> <th>P</th> </tr> </thead> <tbody> <tr> <td>32</td> <td>4</td> </tr> </tbody> </table>	A	P	32	4	<table border="1"> <thead> <tr> <th colspan="2">380 - 440 V 50 a. 60 Hz</th> </tr> </thead> <tbody> <tr> <td colspan="2">5946A</td> </tr> </tbody> </table>	380 - 440 V 50 a. 60 Hz		5946A	
A	P										
32	4										
380 - 440 V 50 a. 60 Hz											
5946A											
	<p>Panel mounted socket with highly heat resistant contact carrier and nickel plated contacts, flange 85 x 75 mm, straight</p> <p>IP 67 Std. Pack. Qty: 10 Drawing: 1 MB 141</p>	<table border="1"> <thead> <tr> <th>A</th> <th>P</th> </tr> </thead> <tbody> <tr> <td>32</td> <td>4</td> </tr> </tbody> </table>	A	P	32	4	<table border="1"> <thead> <tr> <th colspan="2">380 - 440 V 50 a. 60 Hz</th> </tr> </thead> <tbody> <tr> <td colspan="2">2123A</td> </tr> </tbody> </table>	380 - 440 V 50 a. 60 Hz		2123A	
A	P										
32	4										
380 - 440 V 50 a. 60 Hz											
2123A											
	<p>Plug AM-TOP with highly heat resistant contact carrier and nickel plated contacts, with screw terminals and single part body</p> <p>IP 67 Std. Pack. Qty: 10</p>	<table border="1"> <thead> <tr> <th>A</th> <th>P</th> </tr> </thead> <tbody> <tr> <td>32</td> <td>4</td> </tr> </tbody> </table>	A	P	32	4	<table border="1"> <thead> <tr> <th colspan="2">380 - 440 V 50 a. 60 Hz</th> </tr> </thead> <tbody> <tr> <td colspan="2">2175B</td> </tr> </tbody> </table>	380 - 440 V 50 a. 60 Hz		2175B	
A	P										
32	4										
380 - 440 V 50 a. 60 Hz											
2175B											
	<p>Phase sequence test plug earthing contact in the 3 o'clock position, conforming to VDE 0413 part 7</p> <p>IP 44 Std. Pack. Qty: 5</p>	<table border="1"> <thead> <tr> <th>A</th> <th>P</th> </tr> </thead> <tbody> <tr> <td>32</td> <td>4</td> </tr> </tbody> </table>	A	P	32	4	<table border="1"> <thead> <tr> <th colspan="2">380 - 440 V 50 a. 60 Hz</th> </tr> </thead> <tbody> <tr> <td colspan="2">3718</td> </tr> </tbody> </table>	380 - 440 V 50 a. 60 Hz		3718	
A	P										
32	4										
380 - 440 V 50 a. 60 Hz											
3718											

Special plugs and sockets – For reefer containers

Ground contact at 3 o'clock position conforming to DIN VDE 0623, EN 60309-2.
Other versions available on request. For drawings and dimensions see page 102 - 110.

 <p>Panel mounted inlet with highly heat resistant contact carrier and nickel plated contacts, with hinged lid</p> <p>IP 67 Std. Pack. Qty: 10 Drawing: 2 MB 40</p>	A	P	380 - 440 V 50 a. 60 Hz
	32	4	2692

 <p>Connector AM-TOP with highly heat resistant contact carrier and nickel plated contacts, with screw terminals and single part body</p> <p>IP 67 Std. Pack. Qty: 10</p>	A	P	380 - 440 V 50 a. 60 Hz
	32	4	2177A

 <p>Protective cap for plugs 32 A, 4 p</p> <p>Std. Pack. Qty: 10</p>	Part no.		
	40841		

 <p>Holder for plugs 32 A, 4 p</p> <p>Std. Pack. Qty: 10</p>	Part no.		
	41342		

Special plugs and sockets – For reefer containers

Protection type IP 67.

Ground contact at 3 o'clock position conforming to DIN VDE 0623, EN 60309-2. Other versions available on request. Sockets switched, with mechanical DUO-interlock with highly heat resistant contact carrier and nickel plated contacts. For drawings and dimensions see page 111 - 112. It is self-evident for us to offer customized solutions which are especially made for your demand. Please contact us!



AIDAbella, Jos. L. Meyer-Werft, Papenburg, Germany

CEE sockets

3 CEE 32 A, 4 p, 380-440 V, 3 h
For reefer containers, switched,
with mechanical DUO-interlock

CEE sockets

Sockets British standard

Fusing

3 MCB's 32 A, 3 p, C
1 earth bolt M 10, V2A

Connection

For 1 cable up to 5 x 25 mm²

Connection and load values

Pre-fuse max. 100 A
I_{nA} 58 A
RDF 0.6

Enclosure size

520 x 225 mm (H x W)

Part no.

940027



Jos. L. Meyer-Werft, Papenburg, Germany

Special plugs and sockets – TM for military purpose

to DIN EN 60309-2, colour: bronze-green RAL 6031-F9. Other voltages and frequencies available on request.
For drawings and dimensions see page 102 - 110.

Defence Equipment Standard 96919 and 96926.



MENNEKES TM plugs and sockets, colour bronze-green RAL 60301, have been designed to stand up to especially tough conditions. TM plugs and sockets in accordance with VG 96919 or VG 96926 are suitable for use at ambient temperatures from -35 °C to +60 °C. At ambient temperatures over +40 °C the rated current must be reduced.



Panel mounted socket TM

highly heat resistant contact carrier, nickel plated contacts, straight, (form AS)
63 A: X-CONTACT

IP 67
Std. Pack. Qty: 10/5
Drawing: 1 MB 217/1

A	P	230 V 50 a. 60 Hz	400 V 50 a. 60 Hz	440 V- 460 V 60 Hz	>50 - 500 V >300-500 Hz
16	3	22928 AS013			
16	5	23151 AS002	20458 AS001	23163 AS003	23175 AS004
32	3	23293A AS042			
32	5	23152 AS006	20459 AS005	23164 AS007	23176 AS008
63	5	23153 AS010	20460 AS009	23165 AS011	23177 AS012



Panel mounted socket TM

X-CONTACT,
highly heat resistant contact carrier, nickel plated contacts, straight, (form AS)

IP 67
Std. Pack. Qty: 5
Drawing: 1 MB 212/258

A	P	230 V 50 a. 60 Hz	400 V 50 a. 60 Hz	440 V- 460 V 60 Hz	>50 - 500 V >300-500 Hz
125	5		23432 AS014		



Panel mounted socket TM

highly heat resistant contact carrier, nickel plated contacts, 20° inclination, (form BS)
63 A: X-CONTACT

IP 67
Std. Pack. Qty: 10/5
Drawing: 1 MB 474

A	P	230 V 50 a. 60 Hz	400 V 50 a. 60 Hz	440 V- 460 V 60 Hz	>50 - 500 V >300-500 Hz
16	3	24630 BS017			
16	5	24641 BS002	24640 BS001	24642 BS003	24643 BS004
32	3	24730 BS042			
32	5	24741 BS006	24740 BS005	24742 BS007	24743 BS008
63	5	24841 BS010	24840 BS009	24842 BS011	24843 BS012



Panel mounted socket TM

X-CONTACT,
highly heat resistant contact carrier, nickel plated contacts, 15° inclination, (form BS)

IP 67
Std. Pack. Qty: 5
Drawing: 1 MB 339

A	P	230 V 50 a. 60 Hz	400 V 50 a. 60 Hz	440 V- 460 V 60 Hz	>50 - 500 V >300-500 Hz
125	5		22189A BS013		

Special plugs and sockets – TM for military purpose

to DIN EN 60309-2, colour: bronze-green RAL 6031-F9. Other voltages and frequencies available on request.
For drawings and dimensions see page 102 - 110.

 <p>Plug AM-TOP TM highly heat resistant contact carrier, nickel plated contacts, with protective cap, (form CP)</p> <p>IP 67 Std. Pack. Qty: 10</p>	A	P	230 V 50 a. 60 Hz	400 V 50 a. 60 Hz	440 V- 460 V 60 Hz	>50 - 500 V >300-500 Hz
	16	3	24660 CP017			
	16	5	24671 CP002	24670 CP001	24672 CP003	24673 CP004
	32	3	24760 CP042			
	32	5	24771 CP006	24770 CP005	24772 CP007	24773 CP008
 <p>Plug PowerTOP® Xtra TM rubberised grip area, frame terminals, highly heat resistant contact carrier, nickel plated contacts, cable gland and sealing, strain relief and protection against kinking, enclosure with thread lock, two safety slides, with protective cap, (form CP)</p> <p>IP 67 Std. Pack. Qty: 5</p>	A	P	230 V 50 a. 60 Hz	400 V 50 a. 60 Hz	440 V- 460 V 60 Hz	>50 - 500 V >300-500 Hz
	63	5		24870 CP009		24873 CP012
	125	5		24970 CP013		24973 CP016
 <p>Panel mounted inlet TM highly heat resistant contact carrier, nickel plated contacts, with protective cap, (form BP)</p> <p>IP 67 Std. Pack. Qty: 10/5 Drawing: 2 MB 62/1</p>	A	P	230 V 50 a. 60 Hz	400 V 50 a. 60 Hz	440 V- 460 V 60 Hz	>50 - 500 V >300-500 Hz
	16	3	24210 BP013			
	16	5		20461 BP001		
	32	3	23249 BP042			
	32	5		20462 BP005		
 <p>Panel mounted inlet TM highly heat resistant contact carrier, nickel plated contacts, with protective cap, (form AP)</p> <p>IP 67 Std. Pack. Qty: 5 Drawing: 2 MB 206</p>	A	P	230 V 50 a. 60 Hz	400 V 50 a. 60 Hz	440 V- 460 V 60 Hz	>50 - 500 V >300-500 Hz
	125	5		23433		
 <p>Connector AM-TOP TM highly heat resistant contact carrier, nickel plated contacts, with protective cap, (form DS)</p> <p>IP 67 Std. Pack. Qty: 10</p>	A	P	230 V 50 a. 60 Hz	400 V 50 a. 60 Hz	440 V- 460 V 60 Hz	>50 - 500 V >300-500 Hz
	16	3	24675 DS017			
	16	5	24686 DS002	24685 DS001	24687 DS003	24688 DS004
	32	3	24775 DS042			
	32	5	24786 DS006	24785 DS005	24787 DS007	24788 DS008
 <p>Connector PowerTOP® Xtra TM X-CONTACT, rubberised grip area, frame terminals, highly heat resistant contact carrier, nickel plated contacts, cable gland and sealing, strain relief and protection against kinking, enclosure with thread lock, two safety slides, with protective cap, (form DS)</p> <p>IP 67 Std. Pack. Qty: 5</p>	A	P	230 V 50 a. 60 Hz	400 V 50 a. 60 Hz	440 V- 460 V 60 Hz	>50 - 500 V >300-500 Hz
	63	5		24885 DS009		24888 DS012
	125	5		24985 DS013		24988 DS016

Special plugs and sockets – Camping

For drawings and dimensions see page 102 - 110.

	<p>Wall mounted socket with Twin-CONTACT screwless spring terminal, external fixing</p> <p>IP 44 Std. Pack. Qty: 10 Drawing: 1 MB 463</p>	<table border="1"> <thead> <tr> <th>Description</th> <th>Part no.</th> </tr> </thead> <tbody> <tr> <td>16 A, 3 p, 230 V</td> <td>1341</td> </tr> </tbody> </table>	Description	Part no.	16 A, 3 p, 230 V	1341					
Description	Part no.										
16 A, 3 p, 230 V	1341										
	<p>Panel mounted socket with eyelet, 20° inclination, flange: 68 x 62 mm, fixing hole spacing: 47 x 47 mm</p> <p>IP 44 Std. Pack. Qty: 10 Drawing: 1 MB 456</p>	<table border="1"> <thead> <tr> <th>Description</th> <th>Part no.</th> </tr> </thead> <tbody> <tr> <td>16 A, 3 p, 230 V</td> <td>851</td> </tr> <tr> <td>Plug with eyelet 16 A, 3 p, 230 V, for panel mounted socket 851</td> <td>852</td> </tr> </tbody> </table>	Description	Part no.	16 A, 3 p, 230 V	851	Plug with eyelet 16 A, 3 p, 230 V, for panel mounted socket 851	852			
Description	Part no.										
16 A, 3 p, 230 V	851										
Plug with eyelet 16 A, 3 p, 230 V, for panel mounted socket 851	852										
	<p>Plug ProTOP cable gland and sealing, strain relief and protection against kinking, enclosure with thread lock and safety slide</p> <p>IP 44 Std. Pack. Qty: 10</p>	<table border="1"> <thead> <tr> <th>Description</th> <th>Part no.</th> </tr> </thead> <tbody> <tr> <td>16 A, 3 p, 230 V</td> <td>148A</td> </tr> </tbody> </table>	Description	Part no.	16 A, 3 p, 230 V	148A					
Description	Part no.										
16 A, 3 p, 230 V	148A										
	<p>Built-in Plug nickel plated contacts</p> <p>IP 44 Std. Pack. Qty: 10 Drawing: 2 MB 70</p>	<table border="1"> <thead> <tr> <th>Description</th> <th>Part no.</th> </tr> </thead> <tbody> <tr> <td>16 A, 3 p, 230 V, Lid: electric grey</td> <td>8001</td> </tr> <tr> <td>16 A, 3 p, 230 V, Lid: black</td> <td>8008</td> </tr> <tr> <td>Counter frame for built-in plugs CaraCONTACT 8001 and 8008</td> <td>40744</td> </tr> </tbody> </table>	Description	Part no.	16 A, 3 p, 230 V, Lid: electric grey	8001	16 A, 3 p, 230 V, Lid: black	8008	Counter frame for built-in plugs CaraCONTACT 8001 and 8008	40744	
Description	Part no.										
16 A, 3 p, 230 V, Lid: electric grey	8001										
16 A, 3 p, 230 V, Lid: black	8008										
Counter frame for built-in plugs CaraCONTACT 8001 and 8008	40744										
	<p>Connector ProTOP cable gland and sealing, strain relief and protection against kinking, enclosure with thread lock and safety slide</p> <p>IP 44 Std. Pack. Qty: 10</p>	<table border="1"> <thead> <tr> <th>Description</th> <th>Part no.</th> </tr> </thead> <tbody> <tr> <td>16 A, 3 p, 230 V</td> <td>180AC</td> </tr> </tbody> </table>	Description	Part no.	16 A, 3 p, 230 V	180AC					
Description	Part no.										
16 A, 3 p, 230 V	180AC										
	<p>Angled connector with grommet</p> <p>IP 44 Std. Pack. Qty: 10</p>	<table border="1"> <thead> <tr> <th>Description</th> <th>Part no.</th> </tr> </thead> <tbody> <tr> <td>16 A, 3 p, 230 V</td> <td>1438</td> </tr> </tbody> </table>	Description	Part no.	16 A, 3 p, 230 V	1438					
Description	Part no.										
16 A, 3 p, 230 V	1438										

Special plugs and sockets – Switch disconnectors made of AMELAN

Disconnecting property in acc. with EN 60947 (up to 690 V). Finger protection in acc. with DIN 57106 / VDE 0106 T.100. Products with additional aux.contact (1 x NO and 1 x NC). For drawings and dimensions see page 102 - 110.

	Switch disconnector rigid enclosures, ample space for wiring, padlocking facilities, excellent switching capacity, open terminals and captive terminal screws	<table border="1"> <thead> <tr> <th>Rated Current Ampere</th> <th>Poles</th> <th>Auxiliary contact</th> <th>BS Motor rating AC3/440 V kilowatt</th> <th>Part no.</th> </tr> </thead> <tbody> <tr> <td>25</td> <td>3</td> <td></td> <td>7,5</td> <td>52241MEG</td> </tr> <tr> <td>25</td> <td>3</td> <td>✓</td> <td>7,5</td> <td>52242MEG</td> </tr> <tr> <td>40</td> <td>3</td> <td></td> <td>18,5</td> <td>52243MEG</td> </tr> <tr> <td>40</td> <td>3</td> <td>✓</td> <td>18,5</td> <td>52244MEG</td> </tr> <tr> <td>80</td> <td>3</td> <td></td> <td>30.0</td> <td>52245MEG</td> </tr> <tr> <td>80</td> <td>3</td> <td>✓</td> <td>30.0</td> <td>52246MEG</td> </tr> </tbody> </table>	Rated Current Ampere	Poles	Auxiliary contact	BS Motor rating AC3/440 V kilowatt	Part no.	25	3		7,5	52241MEG	25	3	✓	7,5	52242MEG	40	3		18,5	52243MEG	40	3	✓	18,5	52244MEG	80	3		30.0	52245MEG	80	3	✓	30.0	52246MEG
	Rated Current Ampere	Poles	Auxiliary contact	BS Motor rating AC3/440 V kilowatt	Part no.																																
	25	3		7,5	52241MEG																																
	25	3	✓	7,5	52242MEG																																
	40	3		18,5	52243MEG																																
	40	3	✓	18,5	52244MEG																																
	80	3		30.0	52245MEG																																
80	3	✓	30.0	52246MEG																																	
IP 67 Std. Pack. Qty: 1 Drawing: 1 MB 412/3																																					

Characteristics switch disconnector						
			without aux. contact	with aux. contact	without aux. contact	with aux. contact
Part numbers			52241MEG	52242MEG	52243MEG	52244MEG
Rated operational voltage U_e						
IEC / EN / VDE / SEV			690 V		690 V	690 V
Main switch: Isol. voltage up to			690 V		690 V	690 V
Rated continuous current I_u						
IEC / EN / VDE			25 A		40 A	80 A
Rated operational current I_e						
IEC / EN			25 A		40 A	80 A
Rated operational current at 50 up to 60 Hz						
AC-23A	IEC / EN / VDE					
	3 phase	220-240 V	5.5 kW		11.0 kW	18.5 kW
	3 pole	380-440 V	11.0 kW		22.0 kW	18.5 kW
		600-690 V	11.0 kW		18.5 kW	30.0 kW
AC-3	IEC / EN / VDE					
	3 phase	220-240 V	4.0 kW		7.5 kW	15.0 kW
	3 pole	380-440 V	7.5 kW		18.5 kW	30.0 kW
		600-690 V	7.5 kW		15.0 kW	30.0 kW
Rated breaking capacity						
AC-23 A / AC-3 motor switch		220-240 V	220 A		350 A	550 A
		380-440 V	220 A		350 A	550 A
		600-690 V	135 A		190 A	285 A
Maximum fuse size (gL)			35 A		63 A	80 A
Terminal cross section						
Single / multiple wire		min.	1.0 mm ²		4.0 mm ²	6.0 mm ²
		max.	6.0 mm ²		16.0 mm ²	35.0 mm ²
Fine-strand wire with sleeve		min.	0.75 mm ²		2.5 mm ²	6.0 mm ²
		max.	4.0 mm ²		10.0 mm ²	25.0 mm ²

Characteristics auxiliary contacts						
Part numbers			52242MEG	52244MEG	52246MEG	
Auxiliary module			500 V	690 V	690 V	
Rated operational voltage U_e						
Rated continuous current I_u			16 A	16 A	16 A	
Rated operational current I_e						
AC-15A		IEC / EN	220-240 V	380-440 V	2.5 A / 1.5 A	6 A / 3 A
					6 A / 4 A	
Terminal cross section						
Single / multiple wire		min.	1.0 mm ²		1.0 mm ²	1.0 mm ²
Fine-strand wire with sleeve		max.	1.5 mm ²		2.5 mm ²	2.5 mm ²

Service – References



BMW motorcycle plant, Berlin – Germany



AIDAbella, Jos. L. Meyer Werft, Papenburg – Germany



Formula 1 circuit, Manama – Bahrain



Constitution, Heerema Marine Contractors – Netherland



Port of Salalah – Oman



Container Terminal, Le Havre – France

Service – References



Container Terminal, Altenwerder – Germany



Yas Marina Circuit, (Formula 1 Race Course), Abu Dhabi – UAE



Shanghai International Circuit, (Formula 1 Race Course),
Shanghai – China



Brunnenmarkt, (Market Square), Vienna – Austria



KORDSA GLOBAL A.S., Industrial Yarn and Cord Factory, Izmit – Turkey



Bauernmarkt, (Market Square), Hannover – Germany

Service – Regulations and standards

While correct to the best of our knowledge, the information we provide with respect to laws and regulations is in no way binding. Such information is provided purely by way of assistance and makes no claim to completeness. The nature and composition of our appliances are exclusively as quoted in the product description to which the part numbers refer directly.

Installation guidelines

It is best to proceed carefully with the installation and the use of electrical devices. The valid directives and standards, as well as the legal accident prevention regulations must be complied with. The installer is responsible for compliance with the respective regulations.

MENNEKES CEE plugs and sockets conform to the following standards and regulations:

IEC 60309-1
IEC 60309-2
EN 60309-1
EN 60309-2
IEC 60309-1/VDE 0623 part 1
IEC 60309-2/VDE 0623 part 2

Applications

CEE plugs and sockets can and, under certain circumstances, must be used in industry, in commerce, in agriculture, in parks, in damp and wet environments, outdoors, on building sites, in caravans, on boats and yachts, on camp sites, for dockside power supply installations (marinas), on works premises where there is a fire hazard, at markets and fairground booths and for trailers and mobile homes.

Using CEE plugs and sockets will usually enable the planners and builders of electrical installations to comply with the „regulations for the construction of low voltage systems as per DIN VDE 0100“.

Enclosure material

Plastic material

MENNEKES generally uses high-grade plastic material with the following excellent properties: Excellent electrical insulation, break-proof, wear-resistant, abrasion-resistant, dimensionally stable, self-extinguishing, heat-resistant, cold-resistant, stabilised against aging, resistant to seawater, oil, and petrol. For use in industrial premises or place of work where the use of chemicals or other aggressive substances makes it necessary to use other plastic materials, MENNEKES offers products with increased stability against fuel, oil and grease, diluted acids and alkali, cleaner and the most aqueous salt solutions. These products are marked in the catalogue with . Products made of this plastic combine high mechanical, thermal and electrical properties with excellent dimensional stability and resistance to chemicals and are fit for action in chemical plants, in refineries, in the food processing industry, in washdown areas and so on.

Solid rubber

Solid rubber blends are preferably used wherever products are exposed to high mechanical and/or chemical loads. Solid rubber excels by its outstanding dimensional stability; it is largely resistant to acid and lye and has a high resistance to breakdown and leakage current. Products made from solid rubber blends, e.g. MENNEKES EverGUM, are resistant to weather and ageing. Under UV radiation, colour pigments may fade with time. This is inevitable even to the latest state of the art yet it does not compromise the function in any way.

Stainless steel

Our high-quality stainless steel products are ideally suited for continuous use in buildings and outdoors. There is a potential risk of corrosion in open air and indoor swimming pools, in coastal regions, offshore and in industrial areas with high air pollution. Subject to location and climatic conditions discoloration and corrosion can arise. Through specific cleaning and maintenance procedures, impairments of the surface can be reduced or avoided. In particularly aggressive ambient conditions we recommend the use of special stainless steels or coating the surfaces to further increase corrosion resistance.

Contact material, small parts

Female and male contacts are made of brass; screws, springs, etc. are made of rust-proof material or surface-coated steel.

Characteristics of CEE plugs and sockets

MENNEKES CEE plugs and sockets are distinguished by the following features, which keep maintenance costs to a minimum:

- Easy to install
- Wiring space easily accessible
- Power screwdrivers can be used for installation
- Mostly fitted with Pozidriv screws (size 2)
- High contact pressure
- Low effort required for insertion and withdrawal
- Low transition resistance
- Easy-to-grip plugs

Application

CEE plugs and sockets with operating voltages up to 1000 V DC or AC, frequencies up to 500 Hz and rated currents up to 800 A, including plugs and sockets for low voltage systems have become the standard all over the world. Basically suitable for indoor and outdoor applications in industry, they are also used on building sites, farms, commercial premises, for caravans, mobile homes, boats, yachts and in households. CEE plugs and sockets are polarised and non-reversible.

Ambient temperature

CEE plugs and sockets are suitable for ambient temperatures between -25 °C up to +40 °C.

Low voltage directive 2014/35/EU

CEE plugs and sockets are subject to the EC low voltage directive and must therefore be provided with the CE mark to ensure free traffic of goods within the EU. A manufacturer's declaration is available on request.

Service – Regulations and standards

Declaration of Conformity

Current plugs and sockets have been tested by the VDE Test and Certification Institute in Offenbach, Germany. Furthermore, various other certificates from international inspection authorities have been obtained. A copy of test certificates is available on request.

The CE mark is not a compliance mark. MENNEKES CEE plugs and sockets satisfy the requirements specified in the low voltage directive and the device and/or the packaging bears the „CE“ mark „**CEE**“.

Cable glands

Metric	Typical sealing area	Typical capacity of terminal
M 12	2.5 - 6.5 mm	3.0 - 6.5 mm
M 16	2.5 - 8.0 mm	3.5 - 8.0 mm
M 20	5.0 - 12.0 mm	6.0 - 12.0 mm
M 25	9.0 - 18.0 mm	12.0 - 18.0 mm
M 32	14.0 - 25.0 mm	17.0 - 25.0 mm
M 40	18.0 - 32.0 mm	20.0 - 32.0 mm
M 50	24.0 - 38.0 mm	26.0 - 38.0 mm
M 63	30.0 - 44.0 mm	30.0 - 44.0 mm

Standard for low voltage switchgear and control gear assemblies - IEC 61439

The standard, IEC 61439, replaces IEC 60439 and describes the design and the test specifications for low voltage switchgear and control gear assemblies. The new standard has influence on the distribution of electrical energy in industry, the domestic electrical installation and on construction sites.

In 2012, the restructuring and revision of the safety requirements for low voltage switchgear was finalized with publication of the standard, IEC 61439-1:2012. The preceding standard, IEC 60439-1 will be replaced by IEC 61439-1:2012. The former Standard IEC 60439 was replaced by IEC 61439-1:2012 in September 2014. For all switchgear assemblies commissioned after this date, planning and documentation must be in accordance with IEC 61439-1: 2012 and its parts.

The purpose of this standard is the harmonisation of most of the general regulations and requirements for low voltage switchgear and control gear assemblies to achieve uniform requirements and verifications for switchgear and control assemblies and to avoid the necessity of verifications in accordance with other standards. All requirements of the different switchgear and control gear assemblies have been combined in this fundamental standard, together with topics of broad interest and application, e.g heating, insulation properties, etc.

In the future two main standards will be required for each design of a low voltage switchgear and control gear assembly:

- The basic standard that is referenced as „Part 1“ in the specific standards;
- The applicable parts 2 to 7 of the switchgear and control gear assembly standard that deals with the particularities of the application.

The IEC 61439 consists of the following parts:

IEC ...	Replaces IEC ...
61439-1: General definitions	60439-1
61439-2: Power switchgear and control gear assemblies	60439-1
61439-3: Distribution boards	60439-3
61439-4: Assemblies for construction sites	60439-4
61439-5: Public cable distribution cabinets	60439-5
61439-6: Busbar trunking systems	60439-2
61439-7: IEC/TS – specific installations on public sites, marinas, campsites, market squares, and EV charging stations (Draft)	60439-7

Requirements in this standard, which are object of an agreement between manufacturer of the switchgear and control gear assemblies and user, are summarized on page 99 - 101. This listing facilitates provision of information concerning basic conditions and supplemental user definitions.

Design verification

Additionally to the type verification, the producer has to provide an article proof which guarantees a correct set-up acc. to the norm, excludes material failures and the compliance with electrical safety requirements.

Definition – „original manufacturer“ and „manufacturer of the switchgear and control gear assembly“

Original manufacturer

Organisation / enterSockets that executed the original design and the associated verifications in accordance with the standard.

Manufacturer of the switchgear and control gear assembly

Organisation that completes a device and assembles it into a functional unit. The manufacturer is responsible for piece verification and thus for the product (Declaration of Conformity).

Significance for MENNEKES products:

For pre-wired devices MENNEKES is simultaneously the original manufacturer and the manufacturer. The responsibility and provision of verifications rest with us. We cannot declare partially wired devices that we manufacture as standard compliant. In this case the „finishing entity“ becomes the manufacturer and must declare conformity. It is required to forward information to this organisation so that the device ultimately can get a „Declaration of Conformity“.

Service – Regulations and standards

Heating

The max. ambient temperature is +40 °C.

The average value of the ambient temperature over a period of 24 hours must not be higher than +35 °C.

The verification of heating can be provided through various methods. Through testing of the switchgear and control gear combination, or through derivation of a known reference, and through an expert assessment, e.g in accordance with applicable design rules. Regardless of the method that is selected to determine the heat and thus the maximum current load of the combination, compliance with the appropriate temperature limit values must be ensured.

The switchgear and control gear assembly and its electrical circuits must be capable of bearing their rated currents under defined conditions and the rated values of the components, their suitability and application must be taken into account, without exceeding limit values specified in IEC 61439-1 Table 6, Part 1. The limit temperatures in table 6 apply for the average ambient temperature of +35 °C.

► The limit temperatures of the installed equipment must be taken into account!

Heating – replacement of components

A device/component may only be replaced through a similar, identically constructed device of a series other than the series used in the verification, if the power loss, and thus the heating of the connections is less than or equal to that of the device that is being replaced.

Load of the largest electric circuit and of all outgoing circuits individually with rated current

The requirement of IEC 61439 is, that all electric circuits must be individually capable to carry their rated current, without exceeding temperature limit values in the process. If additional power circuits are added, a rated load factor can be set.

Rated values I_{nA} , I_{nC} , RDF

• Standard definition I_{nA}

The rated current of the switchgear and control gear assembly, I_{nA} , is the total current that the main busbar can distribute in the respective installation of the assembly, without exceeding the temperature limit values mentioned in IEC 61439-1 section 9.2!

The current, I_{nA} , is considered to be the maximum current that the assembly can distribute via its outgoing circuits at 100 % continuous duty (CD).

• Standard definition I_{nC}

The rated current of an electric circuit is the value of the current that can be carried by this electric circuit under standard operating conditions when it is operated alone. The assembly must be capable of carrying this current without exceeding the max. temperature limits of the individual components specified in IEC 61439-1 section 9.2.

• Standard definition – rated diversity factor RDF

The RDF is the specified percentage value of the rated current with which the (individual) outgoing circuits I_{nC} of a switchgear and control gear assembly can be continuously and simultaneously be used with due consideration of the opposing thermal influences. In this process the I_{nA} must not be exceeded.

Table 101 from IEC 61439-3 Values for assumed load

Number of main electric circuits	Assumed load factor
2 and 3	0.8
4 and 5	0.7
6, up to and including 9	0.6
10 (and more)	0.5

This table provides guide values, if in doubt the manufacturer's specification always applies.

MENNEKES standard values in accordance with Table C of IEC 61439

The information below represents specified standard values for MENNEKES catalogue assemblies. If there are deviations from this standard or in the case of special project planning, appropriate coordination must take place beforehand between user and manufacturer. These agreements must be arranged between MENNEKES and the user / customer during the quotation phase (prior to production and prior to sale).

The table below is a „blank“ that is applicable for approximately 98 % of the MENNEKES devices. Special project planning is not covered by the specifications, and must be separately disclosed by the user prior to project planning. In these special cases, it is required that additional details be considered with the aid of the standards cited and their product sub-standards (see Section 7.2, in Part 1).

Characteristic	Standard value	Normative option	MENNEKES standard
System according to type of earth connection	Design in accordance with the local requirements	TT / TN / IT	TN / TT
Rated voltage	In accordance with local installation conditions	max. 1000 V AC or 1500 V DC	400 V AC
Transient overvoltages	determined through the electrical system	Overvoltage category I / II / III / IV	Kat. III / plugs and sockets Kat. II
Occasional overvoltages	min. rated voltage + 1200 V	See Table 8 + 9 or 10 for the values	1890 V (AC)
Rated frequency	in accordance with installation conditions	DC / 50 Hz / 60 Hz	50 Hz
Short circuit resistance	determined through the system	N + PE max 60 % of the outer conductor values	I_{cc} max. ≤ 10 kA





Service – Regulations and standards

Characteristic	Standard value	Normative option	MENNEKES standard
SCPD in the supply	in accordance with installation conditions	yes / no	no
Coordination between shortcircuit protection devices inside or outside of the switchgear and control gear assembly	in accordance with installation conditions	present / install / integrate	Item-dependent
Information of loads that could possibly contribute to short-circuit current	No loads are permitted that could possibly contribute to the shortcircuit current	none	none
Type of protection against electric shock – basic insulation	Basic protection	Comply with local requirements	Basic protection
Type of protection against electric shock – earth fault protection	Protection against indirect contact / comply with local requirements	Automatic shutdown / protective disconnect / protective insulation	Item-dependent
Installation site	Execution of the manufacturer	Indoors / outdoors	Item-dependent
Protection type	Indoors min. IP 2x / outdoors min. IP 23	IP xx (A-D)	IP 44
Protection against mechanical effects		if necessary specification of the IK code (IEC 62208)	Information on request
Resistance to UV radiation		Required for enclosures in outdoor installation	Information on request
Resistance to corrosion	For indoor and outdoor installation	yes / no	Item-dependent
Ambient temperature limit values	Indoors: min. -5 °C Outdoors: min. -25 °C High limit (both): +40 °C max. average value (24 h): +35 °C	none	Standard values! see product for deviations
Maximum relative humidity	90 %	Outdoors: 100 % at max. +25 °C Indoors: 50 % bei +40 °C	Standard values! See product for deviations
Pollution degree	Industrial environment 3	1, 2, 3, 4	3
Altitude	≤ 2000 m	Pay attention to the factors	≤ 2000 m
EMC environment	A or B	A / B	B
Special operating conditions (vibration, Ex-area, strong magnetic fields or contamination)	No particular conditions	none	Not defined!
External structural design	in accordance with manufacturer's specifications	Open / closed / standing / in-wall installation & on-wall installation / console	closed
Mobile or stationary	in accordance with manufacturer's specifications	yes / no	Item-dependent
Dimensions and masses	in accordance with manufacturer's specifications	none	Item-dependent
Type of conductors introduced from outside	Cables	Cables / busbar trunking systems	Cables
Materials of the conductors introduced from the outside	Copper	Copper / aluminum	Copper
Cross-sections of the outer conductors, PE, N & PEN conductors	As specified in the standard	none	none
Special requirements imposed on the marking of connections	in accordance with manufacturer's specifications	none	Manufacturer execution
Requirements imposed on storage & transport (type of transport, deviating ambient conditions, max. dimensions, packaging requirements)	Standard of the manufacturer	none	Information on request
Operability (access, activation rights, disconnect)	Easy reachability	Authorized persons, ordinary persons, etc.	Item-dependent
Requirements imposed on accessibility for operation, inspection, maintenance or extension	Inspection, component replacement, extension, maintenance, etc. only by specialized persons (requirement)	none	Inspection, replacement, extension, maintenance, etc. only through specialized persons
Separation of the outgoing electric circuits	in accordance with manufacturer's specifications	Individually / in groups / all	Item-dependent

Service – Regulations and standards

Colour coding

If the rated operating voltage is indicated by a colour coding in addition to compulsory markings, such colour coding must be in accordance with IEC 60309-1:2013-02, table 2:

Rated operating voltage and frequency	Colour code	RAL*
100 to 130 V	yellow 	1021
200 to 250 V	blue 	5007
380 to 480 V	red 	3013
500 to 1.000 V	black 	9005
above 60 to 500 Hz	green 	6010

* RAL determined by MENNEKES, as in EN 60309-1:1999

CEE plugs and sockets for rated operating voltages above 50 V

Position of the earth contact

Plugs and sockets with rated voltages above 50 V must have an earth contact. To prevent incorrect insertion, a nose on the plug fits into a keyway in the socket, thus ensuring that the earth contact pin or tube is correctly positioned in accordance with the required electrical standard. The earth contact positions for the various frequencies and voltages are assigned a clockface position, in accordance with table 104 taken from EN 60309-2:1999 + A1:2007 + A2:2012 (see below).

CEE plugs and sockets for rated voltages of up to 50 V (low voltage)

Since no earth contact is required in plugs and sockets of rated voltage up to 50 V, two keyways instead of one are provided the collar. They are accordingly termed the major and minor keyways. The major keyway is always in the 6 o'clock position. Depending on voltages and frequencies, the minor keyway is always in accordance with table 103 taken from EN 60309-2:1999 + A1:2007 + A2:2012, standard sheet 2-VIII (and in the following drawings).

Drawing: sockets and connectors U = 40 to 50 V, 50 to 60 Hz, minor keyway in 12 o'clock position

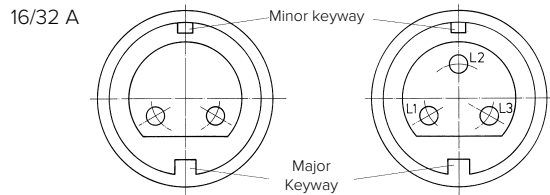



Arrangement of the minor keyway (major keyway 6 o'clock) for various voltages and frequencies using clockface positions in accordance with table 103 taken from EN 60309-2:1999 + A1:2007 + A2:2012

Rated operating voltage V	Frequency Hz	Clockface position of keyway (major keyway = 6 o'clock)	Positions 1 and 9 are reserved for future standards. For design reasons, positions 5, 6 and 7 are not available for use.
20 to 25	50 and 60	no minor keyway	
40 to 50	50 and 60	12	
20 to 25 and 40 to 50	100 to 200	4	
	300	2	
	400	3	
	> 400 to 500	11	
	DC	10	
25	DC*	8 *for portable electrical incubators – use with 12 V or 24 V direct-current voltage in ambulances or helicopters.	

Colour coding

If the rated operating voltage is indicated by a colour coding in addition to compulsory markings, such colour coding must be in accordance with IEC 60309-1:1999, table 2:

Rated operating voltage	Colour code	RAL*
20 to 25 V	violet 	4001
40 to 50 V	white 	7035

* RAL determined by MENNEKES, as in EN 60309-1:1999 no specification is provided for.

Service – Regulations and standards

Interlocks and breaking capacity

Plugs and sockets without an interlock must have an adequate breaking capacity, i.e. it must be possible to insert and withdraw plugs in the manner specified and as often as specified. After testing they must exhibit no damage that would impair further use, and the holes for the plug contacts must not show any significant sign of damage. Sockets and connectors that do not meet the test requirements for breaking capacity and service characteristics must be fitted with an interlock. An interlock is a mechanical or electrical device which ensures that voltage is only applied to the contacts of a plug once they have been inserted into a socket or connector as intended, which prevents a plug being withdrawn with the power switched on or which makes contacts voltage-free before disconnecting. A distinction is made between interlocked plugs and sockets with

- mechanical interlocks
- electrical interlocks.

In the case of sockets and connectors $\geq 63/60$ A, EN 60309-2 requires that a distinction is made between products used with or without interlocks. As MENNEKES plugs and sockets have adequate breaking capacity, standard $\geq 63/60$ A versions are fitted with short contact tubes without pilot contact. In the 63 A and 125 A versions, the short contact tubes meet the finger-touch requirements of IEC 60529. Sockets and connectors 63/60 A for electrical interlocking are fitted with long contact tubes and pilot contact for leading and lagging. The interlock makes up for the lack of finger-touch safety.

Plugs and sockets with mechanical interlocks

Mechanical interlocks for plugs and sockets with a rated operating voltage greater than 50 V must conform to EN 60309-2:1999, standard sheet 2-V. The mechanical switch of a mechanically interlocked socket or connector must not be operational until the proper plug has been inserted. Built-in switches for mechanical interlocking of switched AC sockets must have a breaking capacity conforming at least to IEC 60947-3 (VDE 0660 part 107), utilisation category AC 22. The breaking capacity must be suitable for the appliance connected.

Plugs and sockets with electrical interlocks

In the case of plugs and sockets $\geq 63/60$ A with a rated operating voltage greater than 50 V intended for electrical interlocking (part no. + index „P“), a built-in pilot contact can be used to switch off power to a socket or connector. The requisite switch can either be provided in the socket or on the corresponding circuit distribution board. In the case of sockets with an integrated auxiliary switch fitted behind the pilot tube, the switch is triggered by the pilot pin of the plug. The advantage of this solution is that the pilot tube itself is not live (PCS interlock).

Plugs and sockets for isolating and switching purposes

In accordance with IEC 0100-460, each electrical circuit must be capable of being disconnected from all active conductors of the power supply. This also applies for every piece of electrical equipment, which must be capable of being disconnected from the power supply via an installed or assigned switch. For the term, „disconnect“, the term „isolate“ is also used. As a rule, electrical equipment must be disconnected from the power grid for mechanical and electrical maintenance tasks. According to DIN VDE 0100-537, plugs and sockets isolating all conductors are suitable for the disconnection of power for maintenance purposes if they are able to switch off the load current in the electrical equipment in question. A plug and socket connection is a simple way of satisfying the requirement for „visible isolation“.

Shock hazard protection



Shock hazard protection must be achieved in accordance with EN 60309-1:1999 section 9 by designing plugs and sockets in such a way that, when engaged properly, no live parts of sockets, connectors, plugs and inlets are exposed so that they may be touched.

It must also be impossible to establish a connection of plugs and connectors while any of the contacts are exposed to touch.

Neutral contact tubes and pilot contacts of sockets and connectors are deemed to be live parts.

Protection type

Plugs and sockets used to be classified according to the degree of protection against the entry of moisture:

- splashproof → drop in a triangle 
- watertight → 2 drops 

Today, complete IP protection according to IEC 60529, EN 60529 is specified for plugs and sockets, as they are tested in line with this standard.

IP 44 = Protection from solid bodies with a diameter ≥ 1 mm, splashproof
IP 67 = Protection from dust ingress, protection against temporary immersion

Information on IP protection (IP code) can be found in IEC 60529:2014-09 (VDE 0470 part 1).

Having been properly installed, sockets and connectors must provide the degree of protection defined by the rating, whether the plug is inserted or not.

The protection type for plugs and inlets only applies if they are in contact with the matching piece of the connector or with a fixed cover, if applicable.

CEE plugs and sockets must be IP 44 or IP 67. CEE plugs and sockets with rated currents of 100/125 A must be IP 67.

100/125 A sockets that are fastened to an enclosure or form a structural unit with the enclosure can be IP 44.

For sockets IP 67, a bayonet system has been adopted as the standard in order to simplify their use especially under rough working conditions.

IP 44 or IP 67 is indicated on the appliances.

Notice for the use of mobile power distribution boxes:

Please consider when using SCHUKO® sockets that due to the construction the degree of protection is achieved only when the lid is closed. Otherwise the ingress of water at the ground contact area may not be prevented (see DIN VDE 0620-1 and DIN 49440 et sqq.)

Service – Regulations and standards

Degree of protection of SCHUKO® plugs and sockets. Standard change of DIN VDE 620.

For use in mobile devices, in accordance with the current specifications, attachment sockets that satisfy the IP X4 degree of protection requirements with closed flip-lid cover and with a plugged-in plug in every operating position. Before the standard change in February 2010, the IP X4 degree of protection was considered as fulfilled if the conditions are satisfied with vertical install position of the sockets. For sockets for stationary implementation, this also continues to be the case.

Important application instructions concerning the change in the standard.

- The latest amendment of IEC 620 (March 2013) makes a distinction in the case of IP X4 SCHUKO® sockets, between stationary and mobile implementation conditions
- SCHUKO® IP X4 sockets for stationary and mobile implementation conditions differ in their design (mobile with additional sealing collar, stationary unchanged).
- SCHUKO® IP X4 connectors, like mobile SCHUKO® IP X4 sockets likewise have a supplemental sealing collar.

Attention!

- SCHUKO® plugs > IP X4 (in accordance with DIN 49442, resistant to pressurised water) when plugged into mobile IP X4 SCHUKO® sockets or connectors do not achieve adequate contacting due to the design and thus they must not be operated with such sockets!
- The same applies for AC adapters and angled right angle plugs < IP X4!
- On the appropriate SCHUKO® sockets or connectors this circumstance is presented with an engraved right angle SCHUKO® plug with IP X4 mark.

Before processing, ensure that the SCHUKO® articles at hand correspond to the implementation conditions for which they are intended.







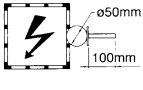

Notice for the use of mobile power distribution boxes with RJ45 data sockets:

The installed data sockets without lid have a degree of protection of IP 20 which is reducing the degree of the whole unit accordingly.

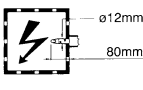
IP protection types for enclosures in accordance with IEC 60529, EN 60529, IEC 60529 (VDE 0470 part 1)

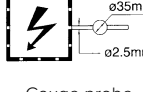





1st number of the code:

Protection against the ingress of foreign bodies and shock hazard protection.

Code	Description			
	Enclosure protected against ingress of:	Test	Protection against contact with:	Test
0				
1	Solid body larger than 50 mm	 Gauge plug diameter Ø 50 mm	Back of hand	 Gauge probe diameter Ø 50 mm
2	Solid body larger than 12.5 mm	 Gauge plug diameter Ø 12.5 mm	Finger	 Jointed metal finger
3	Solid body larger than 2.5 mm	 Gauge plug diameter Ø 2.5 mm	Tool	 Gauge probe diameter Ø 2.5 mm
4	Solid body larger than 1 mm	 Gauge plug diameter Ø 1 mm		 Gauge probe diameter Ø 1 mm
5	Dust in harmful quantities	 Talc	Wire	
6	Dust overall	 Talc		

2nd number of the code:

Protection against the ingress of moisture

Code	Description	
	Enclosure protected against ingress of:	Test
0		
1	Drop of water falling vertically	
2	Drop of water falling vertically on enclosure inclined by up to 15°	
3	Water spray	
4	Splash water	
5	Water jet	
6	Strong water jet	
7	Temporary immersion	
8	Continuous immersion	By arrangement between manufacturer and user. Extra severe test conditions as compared to code 7
9	Water at high pressure and steam cleaning	

Service – Drawings and dimensions

The sizes for the entries on the drawings can be different to the real existing entry sizes. Subject to modification and amendments without prior notice. Errors and omissions excepted.

1 MB 27/30

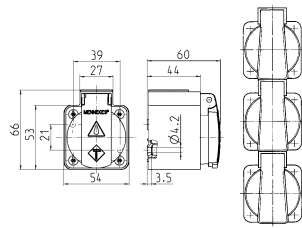

Drawing
1 MB 27/30
Dim. in mm

1 MB 43

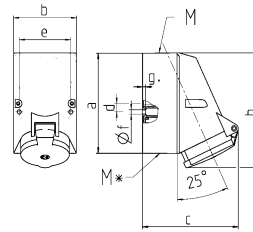

Drawing 1 MB 43	Amp. Poles	16		32		
		4	5	3	4	5
Dim. in mm	a	128	128	128	128	128
	b	84	84	84	84	84
	c	122	124	136	136	138
	d	11	11	11	11	11
	e	68	68	68	68	68
	f	5.3	5.3	5.3	5.3	5.3
	g	4	4	4	4	4
	h	144	145	158	158	160
	M	25	25	32	32	32
	M*	2x25 (blind) to be cut out		2x25 (blind) to be cut out		
Max. cable diam. (mm)		18	18	18/25	18/25	18/25
Terminal for cond. cross section (mm ²) min.-max.		1.5	1.5	2.5	2.5	2.5
		-4	-4	-10	-10	-10

1 MB 43/257

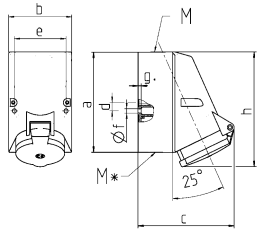

Drawing 1 MB 43_257	Amp. Poles	16		32		
		4	5/7	3	4	5/7
Dim. in mm	a	128	128	128	128	128
	b	84	84	84	84	84
	c	122	124	136	136	138
	d	11	11	11	11	11
	e	68	68	68	68	68
	f	5.3	5.3	5.3	5.3	5.3
	g	4	4	4	4	4
	h	144	145	158	158	160
	M	25	25	32	32	32
	M*	2x25 (blind) to be cut out		2x25 (blind) to be cut out		
Max. cable diam. (mm)		18	18	18/25	18/25	18/25
Terminal for cond. cross section (mm ²) min.-max.		1.5	1.5	2.5	2.5	2.5
		-4	-4	-10	-10	-10

1 MB 112

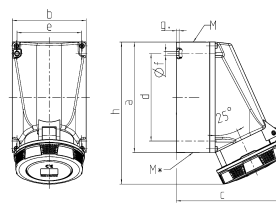

Drawing 1 MB 112	Amp. Poles	63		
		3	4	5
Dim. in mm	a	170	170	170
	b	118	118	118
	c	175	175	175
	d	134.5	134.5	134.5
	e	103	103	103
	f	6.1	6.1	6.1
	g	6	6	6
	h	219	219	219
	M	40	40	40
	M*	2x40 (blind) to be cut out		
Max. cable diam. (mm)		27	27	27
Terminal for cond. cross section (mm ²) min.-max.		6	6	6
		-25	-25	-25

1 MB 136

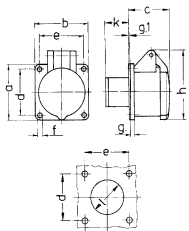

Drawing 1 MB 136	Amp. Poles	16		32	
		2	3	2	3
Dim. in mm	a	55	55	55	55
	b	55	55	55	55
	c	44	44	44	44
	d	45	45	45	45
	e	45	45	45	45
	f	4.2	4.2	4.2	4.2
	g	8	8	8	8
	g.1	2	2	2	2
	h	67	67	67	67
	k	22	22	22	22
	l	34	34	34	34
Terminal for cond. cross section (mm ²) min.-max.		4	4	4	4
		-10	-10	-10	-10

1 MB 137

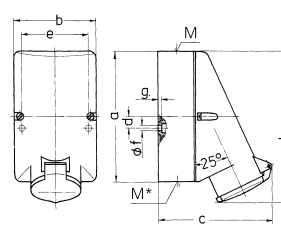

Drawing 1 MB 137	Amp. Poles	16		32	
		2	3	2	3
Dim. in mm	a	128	128	128	128
	b	84	84	84	84
	c	120	120	120	120
	d	11	11	11	11
	e	68	68	68	68
	f	5.3	5.3	5.3	5.3
	g	4	4	4	4
	h	146	146	146	146
	M	25	25	32	32
	M*	2x25 (blind) to be cut out		2x25 (blind) to be cut out	
Max. cable diam. (mm)		18	18	25	25
Terminal for cond. cross section (mm ²) min.-max.		4	4	4	4
		-2x6	-10	-2x6	-10

1 MB 141

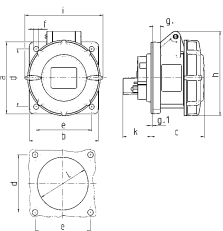

Drawing 1 MB 141	Amp. Poles	16			32		
		3	4	5	3	4	5
Dim. in mm	a	75	75	75	85	85	85
	b	75	75	75	75	75	75
	c	60	61	61	70	70	72
	d	60	60	60	60	60	60
	e	60	60	60	60	60	60
	f	5.5	5.5	5.5	5.5	5.5	5.5
	g	8	8	8	8	8	8
	g.1	2	2	2	2	2	2
	h	83	88	95	99	99	105
	i	78	85	96	103	103	110
	k	31	32	32	39	39	39
	l	43	52	54	58	58	65
Terminal for cond. cross section (mm ²) min.-max.		1.5	1.5	1.5	2.5	2.5	2.5
		-4	-4	-4	-10	-10	-10

1 MB 162

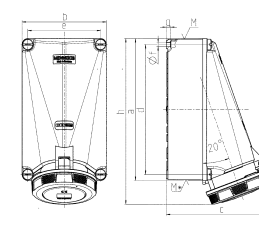

Drawing 1 MB 162	Amp. Poles	125	
		4	5
Dim. in mm	a	264	264
	b	163	163
	c	200	200
	d	240	240
	e	140	140
	f	8.1	8.1
	g	8	8
	h	306	306
	M	50	50
	M*	50	50
Max. cable diam. (mm)		38	38
Terminal for cond. cross section (mm ²) min.-max.		25	25
		-35	-35

1 MB 168

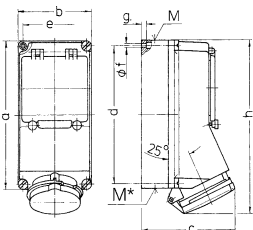

Drawing 1 MB 168	Amp. Poles	16			32		
		3	4	5	3	4	5
Dim. in mm	a	225	225	225	225	225	225
	b	118	118	118	118	118	118
	c	141	141	141	146	146	146
	d	208	208	208	208	208	208
	e	101	101	101	101	101	101
	f	6.3	6.3	6.3	6.3	6.3	6.3
	g	8	8	8	8	8	8
	h	250	252	254	264	264	264
	M	1x25 and 1x32			1x25 and 1x32		
	M*	2x25	2x25	2x25	2x25	2x25	2x25
Max. cable diam. (mm)		25	25	25	25	25	25
Terminal for cond. cross section (mm ²) min.-max.		1.5	1.5	1.5	2.5	2.5	2.5
		-4	-4	-4	-10	-10	-10

1 MB 174

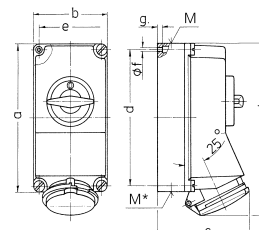

Drawing 1 MB 174	Amp. Poles	16			32		
		3	4	5	3	4	5
Dim. in mm	a	225	225	225	225	225	225
	b	118	118	118	118	118	118
	c	141	141	141	146	146	146
	d	208	208	208	208	208	208
	e	101	101	101	101	101	101
	f	6.3	6.3	6.3	6.3	6.3	6.3
	g	8	8	8	8	8	8
	h	250	252	254	264	264	264
	M	1x25 and 1x32			1x25 and 1x32		
	M*	2x25	2x25	2x25	2x25	2x25	2x25
Max. cable diam. (mm)		25	25	25	25	25	25
Terminal for cond. cross section (mm ²) min.-max.		1.5	1.5	1.5	2.5	2.5	2.5
		-4	-4	-4	-10	-10	-10

1 MB 177

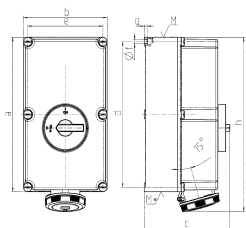

Drawing 1 MB 177	Amp. Poles	125		
		3	4	5
Dim. in mm	a	460	460	460
	b	260	260	260
	c	270	270	270
	d	434	434	434
	e	234	234	234
	f	11	11	11
	g	9	9	9
	h	519	519	519
	M	63	63	63
	M*	2x63	2x63	2x63
Max. cable diam. (mm)		44	44	44
Terminal for cond. cross section (mm ²) min.-max.		25	25	25
		-70	-70	-70

1 MB 180

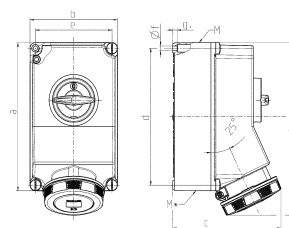

Drawing 1 MB 180	Amp. Poles	63		
		3	4	5
Dim. in mm	a	260	260	260
	b	160	160	160
	c	198	198	198
	d	240	240	240
	e	140	140	140
	f	8.1	8.1	8.1
	g	8	8	8
	h	303	303	303
	M	40	40	40
	M*	2 x 40	2 x 40	2 x 40
Max. cable diam. (mm)		27	27	27
Terminal for cond. cross section (mm ²) min.-max.		6	6	6
		-25	-25	-25

Service – Drawings and dimensions

The sizes for the entries on the drawings can be different to the real existing entry sizes. Subject to modification and amendments without prior notice. Errors and omissions excepted.

1 MB 181/620

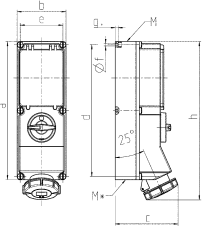

Drawing	Amp.	16				32				63			
		Poles		3	4	5	4	5	4	5	4	5	
Dim. in mm	a	364	364	364	364	364	364	460	460	180	180	180	180
	b	134	134	134	134	134	134	180	180	202	202	202	202
	c	160	162	163	168	168	168	202	202	202	202	202	202
	d	347	347	347	347	347	347	440	440	440	440	440	440
	e	117	117	117	117	117	117	160	160	160	160	160	160
	f	6.3	6.3	6.3	6.3	6.3	6.3	8.1	8.1	8.1	8.1	8.1	8.1
	g	8	8	8	8	8	8	8	8	8	8	8	8
	h	391	395	398	408	411	411	505	505	505	505	505	505
	M	32/40	32/40	32/40	32/40	32/40	32/40	40	40	40	40	40	40
	M*	2x32	2x32	2x32	2x32	2x32	2x32	2x40	2x40	2x40	2x40	2x40	2x40
Max. cable diam. (mm)		27	27	27	27	27	27	27	27	27	27	27	27
Terminal for cond. cross section (mm ²) min.-max.		1.5	1.5	1.5	2.5	2.5	2.5	6	6	6	6	6	6
		-4	-4	-4	-10	-10	-10	-25	-25	-25	-25	-25	-25

1 MB 207

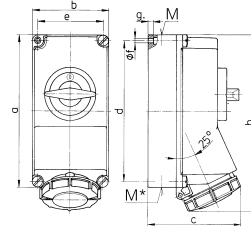

Drawing	Amp.	16				32			
		Poles		3	4	5	3	4	5
Dim. in mm	a	225	225	225	225	225	225	225	225
	b	118	118	118	118	118	118	118	118
	c	144	146	147	152	152	152	153	153
	d	208	208	208	208	208	208	208	208
	e	101	101	101	101	101	101	101	101
	f	6.3	6.3	6.3	6.3	6.3	6.3	6.3	6.3
	g	8	8	8	8	8	8	8	8
	h	252	255	259	268	268	274	268	274
	M	1xM25 and 1xM32	1xM25 and 1xM32	1xM25 and 1xM32	1xM25 and 1xM32	1xM25 and 1xM32	1xM25 and 1xM32	1xM25 and 1xM32	1xM25 and 1xM32
	M*	2x25	2x25	2x25	2x25	2x25	2x25	2x25	2x25
Max. cable diam. (mm)		25	25	25	25	25	25	25	25
Terminal for cond. cross section (mm ²) min.-max.		1.5	1.5	1.5	2.5	2.5	2.5	2.5	2.5
		-4	-4	-4	-10	-10	-10	-10	-10

1 MB 208

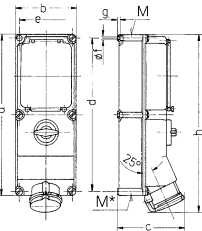

Drawing	Amp.	16				32				63			
		Poles		3	4	5	4	5	4	5	4	5	
Dim. in mm	a	364	364	364	364	364	364	460	460	180	180	180	180
	b	134	134	134	134	134	134	180	180	195	195	195	195
	c	160	162	163	168	168	168	202	202	202	202	202	202
	d	347	347	347	347	347	347	440	440	440	440	440	440
	e	117	117	117	117	117	117	160	160	160	160	160	160
	f	6.3	6.3	6.3	6.3	6.3	6.3	8.1	8.1	8.1	8.1	8.1	8.1
	g	8	8	8	8	8	8	8	8	8	8	8	8
	h	391	395	398	408	411	411	502	502	502	502	502	502
	M	32/40	32/40	32/40	32/40	32/40	32/40	40	40	40	40	40	40
	M*	2x32	2x32	2x32	2x32	2x32	2x32	2x40	2x40	2x40	2x40	2x40	2x40
Max. cable diam. (mm)		27	27	27	27	27	27	27	27	27	27	27	27
Terminal for cond. cross section (mm ²) min.-max.		1.5	1.5	1.5	2.5	2.5	2.5	6	6	6	6	6	6
		-4	-4	-4	-10	-10	-10	-25	-25	-25	-25	-25	-25

1 MB 209

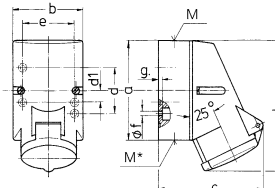

Drawing	Amp.	16			
		Poles		3	4
Dim. in mm	a	87	100	100	100
	b	64	75	75	75
	c	99	110	113	113
	d	40	-	-	-
	d1	-	11	11	11
	e	50	59	59	59
	f	4.5	5	5	5
	g	4	4	4	4
	h	115	125	128	128
	M	20	20	20	20
	M*	M20 (blind) to be cut out			
Max. cable diam. (mm)		15	15	15	15
Terminal for cond. cross section (mm ²) min.-max.		1.5	1.5	1.5	1.5
		-4	-4	-4	-4

1 MB 211

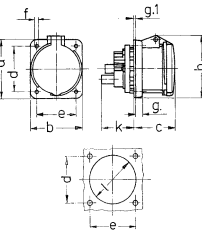

Drawing	Amp.	63			
		Poles		3	4
Dim. in mm	a	107	107	107	107
	b	100	100	100	100
	c	80	80	80	80
	d	85	85	85	85
	e	77	77	77	77
	f	6	6	6	6
	g	12	12	12	12
	g.1	2	2	2	2
	h	113	113	113	113
	k	55	55	55	55
	l	88	88	88	88
Terminal for cond. cross section (mm ²) min.-max.		6	6	6	6
		-25	-25	-25	-25

1 MB 212/258

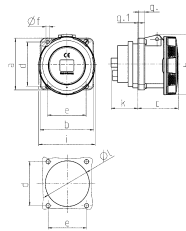

Drawing	Amp.	63				125	
		Poles		3	4	5	4
Dim. in mm	a	107	107	107	130	130	130
	b	100	100	100	130	130	130
	c	81	81	81	119	119	119
	d	85	85	85	104	104	104
	e	77	77	77	104	104	104
	f	6	6	6	6.5	6.5	6.5
	g	12	12	12	18	18	18
	g.1	2	2	2	2	2	2
	h	117	117	117	129	129	129
	i	113	113	113	126	126	126
	k	55	55	55	43	43	43
	l	88	88	88	95	95	95
Terminal for cond. cross section (mm ²) min.-max.		6	6	6	25	25	25
		-25	-25	-25	-70	-70	-70

1 MB 213

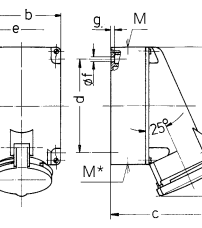

Drawing	Amp.	63			
		Poles		3	4
Dim. in mm	a	170	170	170	170
	b	118	118	118	118
	c	164	164	164	164
	d	134.5	134.5	134.5	134.5
	e	103	103	103	103
	f	6.1	6.1	6.1	6.1
	g	6	6	6	6
	h	216	216	216	216
	M	40	40	40	40
	M*	2xM40 (blind) to be cut out			
Max. cable diam. (mm)		32	32	32	32
Terminal for cond. cross section (mm ²) min.-max.		6	6	6	6
		-25	-25	-25	-25

1 MB 217/1

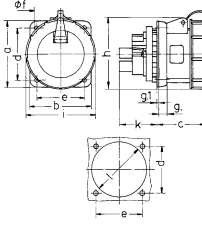

Drawing	Amp.	16				32				63			
		Poles		3	5	3	5	3	5	3	5		
Dim. in mm	a	75	75	75	85	85	107	107	107	107	107	107	107
	b	75	75	75	75	75	100	100	100	100	100	100	100
	c	60	60	67	73	73	82	82	82	82	82	82	82
	d	60	60	60	60	60	85	85	85	85	85	85	85
	e	60	60	60	60	60	77	77	77	77	77	77	77
	f	5.5	5.5	5.5	5.5	5.5	6.5	6.5	6.5	6.5	6.5	6.5	6.5
	g	8	8	8	8	8	12	12	12	12	12	12	12
	g.1	2	2	2	2	2	2	2	2	2	2	2	2
	h	81	95	95	106	115	115	115	115	115	115	115	115
	i	70	88	94	102	114	114	114	114	114	114	114	114
	k	26	27	34	34	55	55	55	55	55	55	55	55
	l	52	57	58	65	88	88	88	88	88	88	88	88
Terminal for cond. cross section (mm ²) min.-max.		1.5	1.5	2.5	2.5	6	6	6	6	6	6	6	6
		-4	-4	-10	-10	-10	-10	-10	-10	-10	-10	-10	-10

1 MB 231

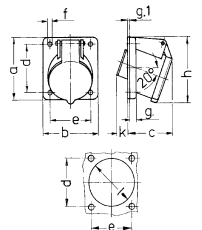

Drawing	Amp.	16				32			
		Poles		2	3	2	3		
Dim. in mm	a	68	68	68	68	68	68	68	
	b	62	62	62	62	62	62	62	
	c	42	42	42	42	42	42	42	
	d	53	53	53	53	53	53	53	
	e	47	47	47	47	47	47	47	
	f	4.5	4.5	4.5	4.5	4.5	4.5	4.5	
	g	8	8	8	8	8	8	8	
	g.1	2	2	2	2	2	2	2	
	h	72	72	72	72	72	7		

Service – Drawings and dimensions

The sizes for the entries on the drawings can be different to the real existing entry sizes. Subject to modification and amendments without prior notice. Errors and omissions excepted.

1 MB 260

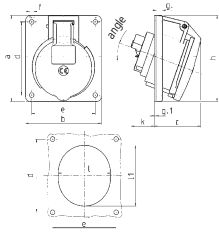

Drawing 1 MB 260	Amp. Poles	16			32		
		3	4	5	3	4	5
Dim. in mm	a	73.5	100	100	100	100	100
	b	64	92	92	92	92	92
	c	50	59	58	62	62	61
	d	60	85	85	85	85	85
	f	5.5	7.7	7.7	7.7	7.7	7.7
	g	7	8	8	8	8	8
	g.1	2	2	2	2	2	2
	h	79	100	100	103	103	106
	k	44	34	34	54	54	49
	l	52	55	65	67	67	72
	lt	60	63	72	82	82	85
	c	20°	20°	20°	20°	20°	20°
Terminal for cond. cross section (mm²) min.-max.		1.5	1.5	1.5	2.5	2.5	2.5
		-4	-4	-4	-10	-10	-10

1 MB 292

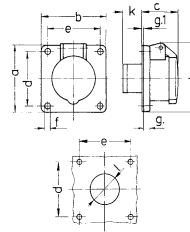

Drawing 1 MB 292	Amp. Poles	16		32	
		2	3	2	3
Dim. in mm	a	75	75	75	75
	b	75	75	75	75
	c	44	44	44	44
	d	60	60	60	60
	e	60	60	60	60
	f	5.5	5.5	5.5	5.5
	g	8	8	8	8
	g.1	2	2	2	2
	h	77	77	77	77
	k	22	22	22	22
	l	34	34	34	34
Terminal for cond. cross section (mm²) min.-max.		4	4	4	4
		-10	-10	-10	-10

1 MB 294

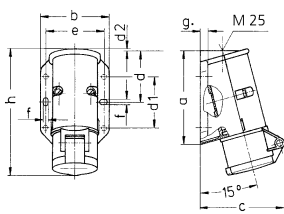

Drawing 1 MB 294	Amp. Poles	16		32	
		2	3	2	3
Dim. in mm	a	96	96	96	96
	b	73	73	73	73
	c	90	90	90	90
	d	53	53	53	53
	d1	52	52	52	52
	d2	2	2	2	2
	e	62	62	62	62
	f	5.3	5.3	5.3	5.3
	g	8	8	8	8
	h	129	129	129	129
Terminal for cond. cross section (mm²) min.-max.		4	4	4	4
		-10	-10	-10	-10

1 MB 297

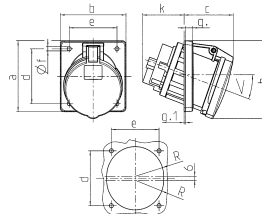

Drawing 1 MB 297	Amp. Poles	63		
		3	4	5
Dim. in mm	a	110	110	110
	b	106	106	106
	c	82	82	82
	d	85	85	85
	e	77	77	77
	f	6.5	6.5	6.5
	g	12	12	12
	g.1	2	2	2
	h	122	122	122
	k	69	69	69
	R	46	46	46
	u	20°	20°	20°
Terminal for cond. cross section (mm²) min.-max.		6	6	6
		-25	-25	-25

1 MB 298/601

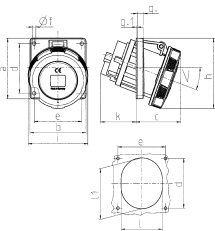

1 MB 298 1 MB 601	Amp. Poles	63			125		
		3	4	5	3	4	5
Dim. in mm	a	110	110	110	114	114	114
	b	106	106	106	110	110	110
	c	85	85	85	75	75	75
	d	85	85	85	90	90	90
	e	77	77	77	90	90	90
	f	6.2	6.2	6.2	6.2	6.2	6.2
	g	12	12	12	13	13	13
	g.1	2	2	2	2	2	2
	h	128	128	128	133	133	133
	i	113	113	113	126	126	126
	k	67	67	67	103	103	103
	l	92	92	92	94	94	94
	lt	98	98	98	107	107	107
	c	20°	20°	20°	15°	15°	15°
	e	6	6	6	25	25	25
Terminal for cond. cross section (mm²) min.-max.		-25	-25	-25	70	70	70

1 MB 305

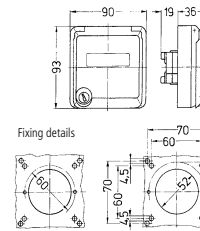

Drawing
1 MB 305

Dim. in mm

1 MB 312

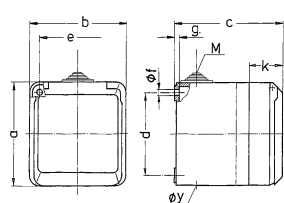

Drawing 1 MB 312	Amp. Poles	16			32		
		3	4	5	3	4	5
Dim. in mm	a	93	93	93	93	93	93
	b	90	90	90	90	90	90
	c	87	87	87	99	99	99
	d	75	75	75	75	75	75
	e	73	73	73	73	73	73
	f	5.5	5.5	5.5	5.5	5.5	5.5
	g	4.2	4.2	4.2	4.2	4.2	4.2
	k	33	33	33	33	33	33
	y	25.5	25.5	25.5	25.5	25.5	25.5
	M	25x1.5	25x1.5	25x1.5	25x1.5	25x1.5	25x1.5
Terminal for cond. cross section (mm²) min.-max.		1.5	1.5	1.5	2.5	2.5	2.5
		-4	-4	-4	-6	-6	-6

1 MB 313

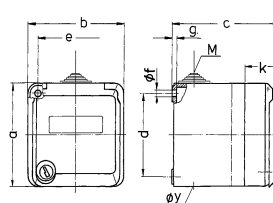

Drawing 1 MB 313	Amp. Poles	16			32		
		3	4	5	3	4	5
Dim. in mm	a	93	93	93	93	93	93
	b	90	90	90	90	90	90
	c	90	90	90	102	102	102
	d	75	75	75	75	75	75
	e	73	73	73	73	73	73
	f	5.5	5.5	5.5	5.5	5.5	5.5
	g	4.2	4.2	4.2	4.2	4.2	4.2
	k	36	36	36	36	36	36
	y	25.5	25.5	25.5	25.5	25.5	25.5
	M	25x1.5	25x1.5	25x1.5	25x1.5	25x1.5	25x1.5
Terminal for cond. cross section (mm²) min.-max.		1.5	1.5	1.5	2.5	2.5	2.5
		-4	-4	-4	-6	-6	-6

1 MB 315

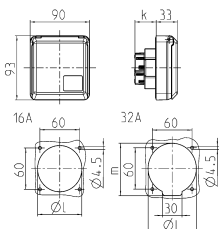

Drawing 1 MB 315	Amp. Poles	16			32		
		3	4	5	3	4	5
Dim. in mm	k	32	32	32	48	48	48
	l	50	60	67	65	65	73
	m	-	-	-	70	70	76
Terminal for cond. cross section (mm²) min.-max.		1.5	1.5	1.5	2.5	2.5	2.5
		-4	-4	-4	-6	-6	-6

1 MB 317

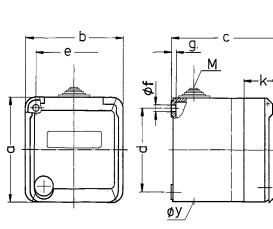

Drawing 1 MB 317	Amp. Poles	16			32		
		3	4	5	3	4	5
Dim. in mm	a	93	93	93	93	93	93
	b	90	90	90	90	90	90
	c	88	88	88	100	100	100
	d	75	75	75	75	75	75
	e	73	73	73	73	73	73
	f	5.5	5.5	5.5	5.5	5.5	5.5
	g	4.2	4.2	4.2	4.2	4.2	4.2
	k	34	34	34	34	34	34
	y	25.5	25.5	25.5	25.5	25.5	25.5
	M	25x1.5	25x1.5	25x1.5	25x1.5	25x1.5	25x1.5
Terminal for cond. cross section (mm²) min.-max.		1.5	1.5	1.5	2.5	2.5	2.5
		-4	-4	-4	-6	-6	-6

1 MB 336

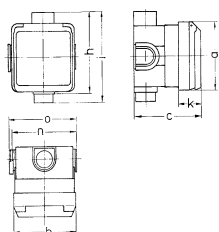

Drawing 1 MB 336	Amp. Poles	16			32		
		3	4	5	3	4	5
Dim. in mm	a	93	93	93	93	93	93
	b	90	90	90	90	90	90
	c	95	95	95	95	95	95
	h	111	111	111	111	111	111
	i	124	124	124	124	124	124
	k	33	33	33	33	33	33
	n	91	91	91	91	91	91
	o	95	95	95	95	95	95
Terminal for cond. cross section (mm²) min.-max.		1.5	1.5	1.5	2.5	2.5	2.5
		-4	-4	-4	-6	-6	-6

1 MB 339

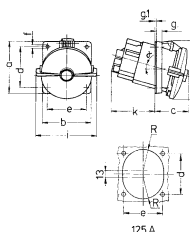

Drawing 1 MB 339	Amp. Poles	125	
		4	5
Dim. in mm	a	114	114
	b	110	110
	c	85	85
	d	90	90
	e	90	90
	f	6.2	6.2
	g	13	13
	g.1	2	2
	h	135	135
	i	135	135
	k	103	103
	R	47	47
	u	15°	15°
Terminal for cond. cross section (mm²) min.-max.		25	25
		70	70

Service – Drawings and dimensions

The sizes for the entries on the drawings can be different to the real existing entry sizes. Subject to modification and amendments without prior notice. Errors and omissions excepted.

1 MB 404/2

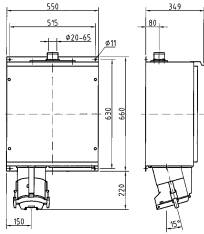

Drawing
1 MB 404/2
Dim. in mm

1 MB 410

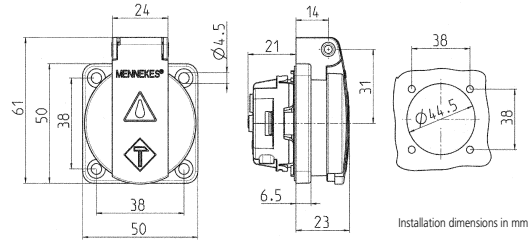

Drawing
1 MB 410
Dim. in mm

1 MB 412

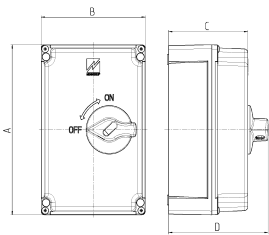

Drawing	Amp. Pole	25 3/3+HS	40 3/3+HS	80 3/3+HS
1 MB 412/3				
Dim. in mm	A	170	263	263
	B	118	168.5	168.5
	C	98	130	130
	D	131	161	161

1 MB 421

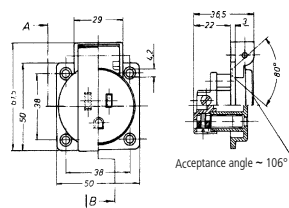

Drawing
1 MB 421
Dim. in mm

1 MB 422

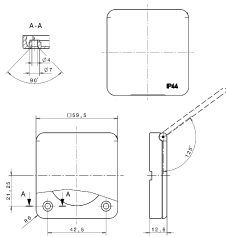

Drawing
1 MB 422
Dim. in mm

1 MB 426

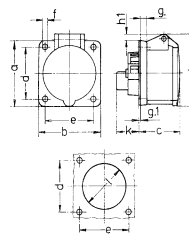

Drawing	Amp. Poles	16 3
1 MB 426		
Dim. in mm	a	55
	b	55
	c	54
	d	45
	e	45
	f	5.5
	g	8
	g.1	2
	h	70
	h1	12
	k	28
	l	47
	Terminal for cond. cross section (mm ²) min.-max.	1.5 / -4

1 MB 450

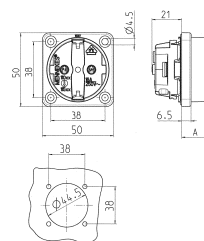

Drawing	Amp. Pole	Dim. A
1 MB 450		
Dim. in mm		
SCHUKO		18.3
French/Belgian standards		15.8
Danish standards		15.8

1 MB 452

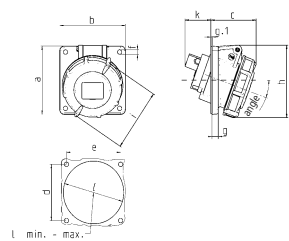

Drawing	Amp. Poles	16	32
1 MB 452		3 4 5	3 4 5
Dim. in mm	a	85 85 85	85 85 85
	b	85 85 85	85 85 85
	c	57 59 60	68 68 72
	d	70 70 70	70 70 70
	e	70 70 70	70 70 70
	f	5.5 5.5 5.5	5.5 5.5 5.5
	g	8 8 8	8 8 8
	g.1	2 2 2	2 2 2
	h	87 91 99	105 105 110
	i	78 85 96	103 103 110
	k	39 34 33	53 53 41
	l min.	57 64 70	78 78 78
	l max.	78 78 78	78 78 78
	Terminal for cond. cross section (mm ²) min.-max.	1.5 1.5 1.5	2.5 2.5 2.5

1 MB 453

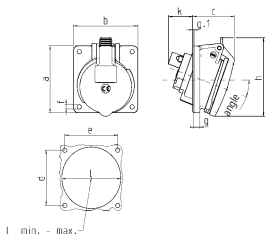

Drawing	Amp. Poles	16	32
1 MB 453		3 4 5	3 4 5
Dim. in mm	a	85 85 85	85 85 85
	b	85 85 85	85 85 85
	c	53 57 57	60 60 67
	d	70 70 70	70 70 70
	e	70 70 70	70 70 70
	f	5.5 5.5 5.5	5.5 5.5 5.5
	g	8 8 8	8 8 8
	g.1	2 2 2	2 2 2
	h	89 96 101	103 103 110
	k	39 34 33	53 53 41
	l min.	57 64 70	78 78 78
	l max.	78 78 78	78 78 78
	Terminal for cond. cross section (mm ²) min.-max.	1.5 1.5 1.5	2.5 2.5 2.5

1 MB 456

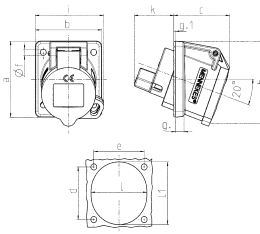

Drawing	Amp. Poles	16 3
1 MB 456		
Dim. in mm	a	68
	b	62
	c	52
	d	47
	e	47
	Øf	5.5
	g	8
	g.1	1.5
	h	74
	i	64
	k	37
	l	52
	Terminal for cond. cross section (mm ²) min.-max.	1.5 / -4

1 MB 463

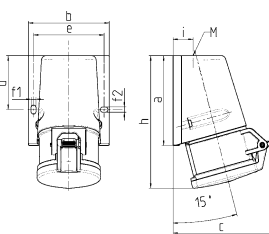

Drawing	Amp. Poles	16	32
1 MB 463		3 4 5	3 4 5
Dim. in mm	a	95 93 92.5	102 102 102
	b	73.5 87.5 87.5	94 94 94
	c	93 107.5 110	115.5 115.5 119.5
	d	55.5 55.5 55.5	62 62 62
	e	61 76 76	84 84 84
	f1	5.3 5.3 5.3	5.1 5.1 5.1
	f2	5.3 5.3 5.3	5.1 5.1 5.1
	h	139 139 136.5	160 160 156.5
	i	19.8 21.5 21.5	26.5 26.5 26.5
	M	M20x M25x M25x	M25x M32x M32x
	Terminal for cond. cross section (mm ²) min.-max.	1.5 1.5 1.5	1.5 1.5 1.5

1 MB 464

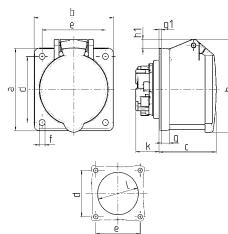

Drawing	Amp. Poles	16	32
1 MB 464		3 4 5	3 4 5
Dim. in mm	a	75 75 75	75 75 75
	b	75 75 75	75 75 75
	c	53 53 54	64 64 64
	d	60 60 60	60 60 60
	e	60 60 60	60 60 60
	f	5.5 5.5 5.5	5.5 5.5 5.5
	g	8 8 8	8 8 8
	g.1	2 2 2	2 2 2
	h	75 80 85	89 89 95
	h1	5 8	10 10 12
	k	22 22 22	28 28 28
	l	43 52 57	60 60 64
	Terminal for cond. cross section (mm ²) min.-max.	1.5 1.5 1.5	2.5 2.5 2.5

Service – Drawings and dimensions

The sizes for the entries on the drawings can be different to the real existing entry sizes. Subject to modification and amendments without prior notice. Errors and omissions excepted.

1 MB 465

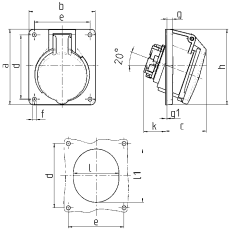

Drawing 1 MB 465	Amp. Poles	16			32		
		3	4	5	3	4	5
Dim. in mm		73.5	100	100	100	100	100
a		64	92	92	92	92	92
b		52	58	58	61	61	60
c		60	85	85	85	85	85
d		52	77	77	77	77	77
e		5.5	5.5	5.5	5.5	5.5	5.5
f		7	8	8	8	8	8
g		2	2	2	2	2	2
g.1		79	100	100	103	103	105
h		31	31	31	44	44	54
k		52	55	65	70	70	73
l		60	63	72	82	82	85
Terminal for cond. cross section (mm ²) min.-max.		1.5	1.5	1.5	2.5	2.5	2.5
		-4	-4	-4	-6	-6	-6

1 MB 466

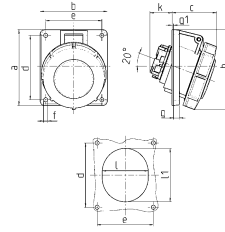

Drawing 1 MB 466	Amp. Poles	16			32		
		3	4	5	3	4	5
Dim. in mm		73.5	100	100	100	100	100
a		64	92	92	92	92	92
b		52	60	62	66	66	66
c		60	85	85	85	85	85
d		52	77	77	77	77	77
e		5.5	5.5	5.5	5.5	5.5	5.5
f		7	8	8	8	8	8
g		2	2	2	2	2	2
g.1		84	100	106	109	109	113
h		31	31	31	44	44	54
k		52	55	65	70	70	73
l		60	63	72	82	82	85
Terminal for cond. cross section (mm ²) min.-max.		1.5	1.5	1.5	2.5	2.5	2.5
		-4	-4	-4	-6	-6	-6

1 MB 467

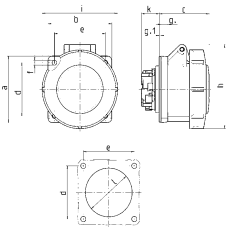

Drawing 1 MB 467	Amp. Poles	16			32		
		3	4	5	3	4	5
Dim. in mm		75	75	75	85	85	85
a		75	75	75	75	75	75
b		60	61	61	69	69	72
c		60	60	60	60	60	60
d		60	60	60	60	60	60
e		5.5	5.5	5.5	5.5	5.5	5.5
f		8	8	8	8	8	8
g		2	2	2	2	2	2
g.1		83	88	95	99	99	105
h		78	85	96	103	103	110
i		21	21	21	28	28	38
k		43	52	54	60	60	65
Terminal for cond. cross section (mm ²) min.-max.		1.5	1.5	1.5	2.5	2.5	2.5
		-4	-4	-4	-6	-6	-6

1 MB 468 - 61 mm ø

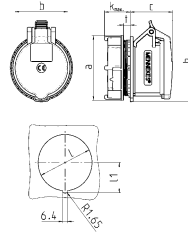

Drawing 1 MB 468	Amp. Poles	16		
		3	4	5
Dim. in mm		69		
a		57		
b		55		
c		max. 30		
k		87		
l		61		
l1		33.25		
t		2-9		
Terminal for cond. cross section (mm ²) min.-max.		1.5		
		-4		

1 MB 468 - 70 mm ø

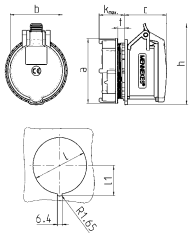

Drawing 1 MB 468	Amp. Poles	16			32		
		4	5	3	4	5	
Dim. in mm		81	81	81	81	81	81
a		66	69	71	71	80	
b		58	55	66	66	64	
c		max. 33	max. 33	max. 33	max. 33	max. 33	
k		100	102	101	101	108	
h		70	70	70	70	70	
l		37.75	37.75	37.75	37.75	37.75	
l1		2-9	2-9	2-9	2-9	2-9	
t		1.5	1.5	1.5	2.5	2.5	
Terminal for cond. cross section (mm ²) min.-max.		-4	-4	-6	-6	-6	

1 MB 472

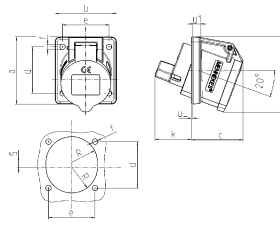

Drawing 1 MB 472	Amp. Poles	16		
		3	4	5
Dim. in mm		68		
a		62		
b		52		
c		47		
d		47		
e		5.5		
f		8		
g		1.5		
g.1		76		
h		37		
k		1.5		
Terminal for cond. cross section (mm ²) min.-max.		-4		

1 MB 474

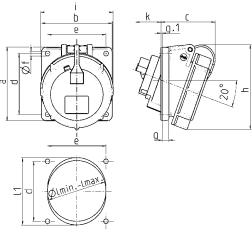

Drawing 1 MB 474	Amp. Pole	16			32		63	
		3	5	3/4	5	3/4/5	5	
Dim. in mm		85	85	85	85	114		
a		85	85	85	85	114		
b		71	65	65	80	98		
c		70	70	70	70	90		
d		70	70	70	70	90		
e		5.5	5.5	5.5	5.5	5.5		
f		8	8	8	8	12		
g		2	2	2	2	2		
g.1		92	98	101	115	135		
h		70	87	94	101	112		
i		39	33	53	53	70		
k		57	70	78	78	92		
l min.		78	78	78	78	105		
l max.		-	-	-	-	105		
Terminal for cond. cross section (mm ²) min.-max.		1.5	1.5	2.5	2.5	6		
		-4	-4	-10	-10	-25		

1 MB 519

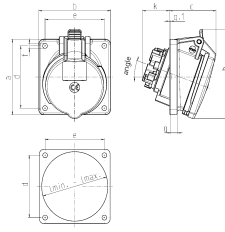

Drawing 1 MB 519	Amp. Poles	16			32		
		3	4	5	3	4	5
Dim. in mm		85	85	85	85	85	85
a		85	85	85	85	85	85
b		52	57	55	61	60	66
c		70	70	70	70	70	70
d		70	70	70	70	70	70
e		5.5	5.5	5.5	5.5	5.5	5.5
f		8	8	8	8	8	8
g		2	2	2	2	2	2
g.1		86	96	100	96	104	110
h		31	32	33	43	44	48
k		57	64	70	78	78	78
l min.		76	76	76	78	78	78
l max.		20	20	20	20	20	20
Terminal for cond. cross section (mm ²) min.-max.		1.5	1.5	1.5	2.5	2.5	2.5
		-4	-4	-4	-10	-10	-10

1 MB 520

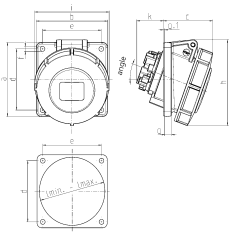

Drawing 1 MB 520	Amp. Poles	16			32		
		3	4	5	3	4	5
Dim. in mm		85	85	85	85	85	85
a		85	85	85	85	85	85
b		56	59	59	64	64	71
c		70	70	70	70	70	70
d		70	70	70	70	70	70
e		5.5	5.5	5.5	5.5	5.5	5.5
f		8	8	8	8	8	8
g		2	2	2	2	2	2
g.1		87	91	99	103	103	110
h		78	85	89	103	103	106
i		32	32	33	44	44	49
k		57	64	70	78	78	78
l min.		76	76	76	78	78	78
l max.		1.5	1.5	1.5	2.5	2.5	2.5
Terminal for cond. cross section (mm ²) min.-max.		-4	-4	-4	-6	-6	-6

1 MB 550

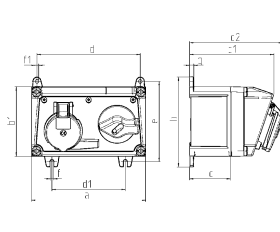

Drawing 1 MB 550	Amp. Poles	16			32		
		3	4	5	3	4	5
Dim. in mm		225	225	225	225	225	225
a		168	168	168	168	168	168
b		130	130	130	130	130	130
b1		80	80	80	80	80	80
c		166	166	166	166	166	166
c1		182	183	183	193	193	193
c2		204	204	204	204	204	204
d		145	145	145	145	145	145
d1		150	150	150	150	150	150
e		7	7	7	7	7	7
f		07	07	07	07	07	07
f1		8	8	8	8	8	8
g							

1 MB 551

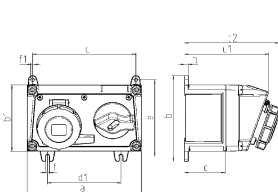

Drawing 1 MB 551	Amp. Poles	16			32		
		3	4	5	3	4	5
Dim. in mm		225	225	225	225	225	225
a		168	168	168	168	168	168
b		130	130	130	130	130	130
b1		80	80	80	80	80	80
c		166	166	166	166	166	166
c1		182	185	186	197	197	198
c2		204	204	204	204	204	204
d		145	145	145	145	145	145
d1		150	150	150	150	150	150
e		7	7	7	7	7	7
f		07	07	07	07	07	07
f1		8	8	8	8	8	8
g							

1 MB 5

Service – Drawings and dimensions

The sizes for the entries on the drawings can be different to the real existing entry sizes. Subject to modification and amendments without prior notice. Errors and omissions excepted.

1 MB 586

Drawing 1 MB 586

Dim. in mm

1 MB 622

Drawing 1 MB 622

Dim. in mm	Amp. Poles	16			32		
		3	4	5	3	4	5
a	100	100	100	100	100	100	100
b	101	101	101	109	109	109	109
c	117	125	131	157	157	160	160
d	50	50	50	50	50	50	50
e	84	84	84	92	92	92	92
fl	5.3	5.3	5.3	5.3	5.3	5.3	5.3
fz	5.3	5.3	5.3	5.3	5.3	5.3	5.3
g	6.5	6.5	6.5	6.5	6.5	6.5	6.5
h	131	131	132	148	148	148	148
i	24.7	24.7	24.7	27.5	27.5	27.5	27.5
M	25 (optional M20)			32 (optional M25)			
M*	2x25 (blind) to be cut out			2x25 (blind) to be cut out			
Max. cable diam. (mm)	18 (M25) and 15 (M20)			25 (M32) and 18 (M25)			
Terminal for cond. cross section (mm²) min.-max.	1.5	1.5	1.5	2.5	2.5	2.5	
	-4	-4	-4	-6	-6	-6	

1 MB 627

Drawing 1 MB 627

Dim. in mm

1 MB 636

Drawing 1 MB 636

Dim. in mm

1 MB 637

Drawing 1 MB 637

Dim. in mm

2 MB 32

Drawing 2 MB 32

Dim. in mm	Amp. Poles	16			32		
		3	4	5	3	4	5
a	87	100	100	128	128	128	128
b	64	75	75	84	84	84	84
c	93	106	110	133	133	135	135
d	40	—	—	—	—	—	—
d1	—	10.5	10.5	11	11	11	11
e	50.5	59	59	68	68	68	68
f	4.5	5	5	5.3	5.3	5.3	5.3
g	4	4	4	4	4	4	4
h	122	133	135	169	169	170	170
M	20	20	20	32	32	32	32
M*	1x20 (blind) to be cut out			2x25 (blind) to be cut out			
Max. cable diam. (mm)	15	15	15	18/25	18/25	18/25	
Terminal for cond. cross section (mm²) min.-max.	1	1	1	2.5	2.5	2.5	
	-2.5	-2.5	-2.5	-6	-6	-6	

2 MB 36

Drawing 2 MB 36

Dim. in mm	Amp. Poles	63			125	
		3	4	5	4	5
a	170	170	170	264	264	264
b	118	118	118	163	163	163
c	171	171	171	205	205	205
d	134.5	134.5	134.5	240	240	240
e	103	103	103	140	140	140
f	6.1	6.1	6.1	8.1	8.1	8.1
g	6	6	6	8	8	8
h	250	250	250	355	355	355
M	40	40	40	50	50	50
M*	2x40	2x40	2x40	50	50	50
a	25*	25*	25*	20*	20*	20*
Max. cable diam. (mm)	27	27	27	38	38	38
Terminal for cond. cross section (mm²) min.-max.	6	6	6	16	16	16
	-16	-16	-16	-35	-35	-35

2 MB 40

Drawing 2 MB 40

Dim. in mm	Amp. Poles	16			32			63		
		5	3	4	5	4	5	4	5	
a	85	85	85	85	114	114	114	114	114	
b	85	85	85	85	85	85	85	85	85	
c	141	141	141	144	180	180	180	180	180	
d	70	70	70	70	90	90	90	90	90	
e	70	70	70	70	90	90	90	90	90	
f	6.2	6.2	6.2	6.2	6.2	6.2	6.2	6.2	6.2	
g	6	6	6	6	6	6	6	6	6	
g.1	2	2	2	2	2	2	2	2	2	
h	181	181	181	188	242	242	242	242	242	
s	86	93	93	100	113	113	113	113	113	
l	30	30	30	30	40	40	40	40	40	
Terminal for cond. cross section (mm²) min.-max.	1	2.5	2.5	2.5	4	4	4	4	4	
	-2.5	-6	-6	-6	-16	-16	-16	-16	-16	

2 MB 43

Drawing 2 MB 43

Dim. in mm	Amp. Poles	16			32		
		4	5	3	4	5	
a	85	85	75	75	75	75	75
b	85	85	90	90	90	90	90
c	104	106	115	115	117	117	117
d	64	64	45	45	45	45	45
d1	10	10	13	13	13	13	13
e	64	64	78	78	78	78	78
f	5.5	5.5	5.5	5.5	5.5	5.5	5.5
g	27	27	27	27	27	27	27
g.1	2	2	1	1	1	1	1
h	140	140	150	150	150	150	150
l	50	50	55	55	55	55	55
Terminal for cond. cross section (mm²) min.-max.	1	1	2.5	2.5	2.5	2.5	2.5
	-2.5	-2.5	-6	-6	-6	-6	-6

2 MB 62/1

Drawing 2 MB 62/1

Dim. in mm	Amp. Poles	16		32		63	
		3	5	3	5	63	5
a	85	85	85	85	85	106	106
b	85	85	85	85	85	101	101
c	128	128	129	135	135	152	152
d	70	70	70	70	70	85	85
e	70	70	70	70	70	77	77
f	6.3	6.3	6.3	6.3	6.3	6.5	6.5
g	11	11	11	11	11	12	12
h	105	107	108	111	111	130	130
s	70	86	92	101.5	101.5	114	114
Terminal for cond. cross section (mm²) min.-max.	1	1	2.5	2.5	4	4	4
	-2.5	-2.5	-6	-6	-6	-10	-10

2 MB 68

Drawing 2 MB 68

Dim. in mm	Amp. Poles	16		32	
		5	5	5	5
a		66		72	
a1		69		78	
b		66		72	
c		43		52	
d		52		60	
e		52		60	
f		4.5		4.5	
g		4.5		4.5	
g.1		2		2	
k		27		32	
l		59		63	
Terminal for cond. cross section (mm²) min.-max.		1		2.5	
		-2.5		-6	

2 MB 68/853

Drawing 2 MB 68/853

Dim. in mm	Amp. Poles	16	
		5	5
a		75	
b		75	
c		42	
d		60	
e		60	
f		5.5	
g		7.3	
g.1		2	
k		13	
l		52	
Terminal for cond. cross section (mm²) min.-max.		1	
		-2.5	

Service – Drawings and dimensions

The sizes for the entries on the drawings can be different to the real existing entry sizes. Subject to modification and amendments without prior notice. Errors and omissions excepted.

2 MB 70

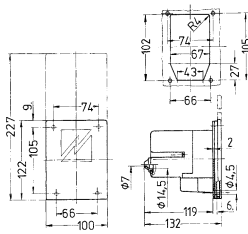

Drawing
2 MB 70
Dim. in mm

2 MB 71

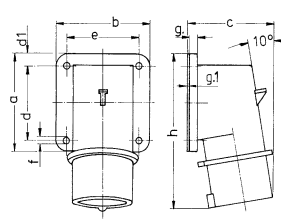

Drawing	Amp.	16		32	
2 MB 71	Poles	7		7	
Dim. in mm	a	85		75	
	b	85		90	
	c	79		90	
	d	64		45	
	d1	10		13	
	e	64		78	
	f	5.5		5.5	
	g	6		6	
	g.1	2		2	
	h	129		138	
Terminal for cond. cross section (mm ²) min.-max.		1		2.5	
		-2.5		-6	

2 MB 73

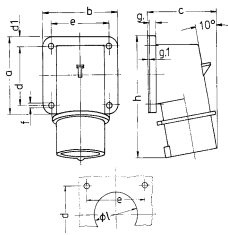

Drawing	Amp.	16		32		
2 MB 73	Poles	4	5	3	4	5
Dim. in mm	a	85	85	75	75	75
	b	85	85	90	90	90
	c	75	79	87	87	90
	d	64	64	45	45	45
	d1	10	10	13	13	13
	e	64	64	78	78	78
	f	5.5	5.5	5.5	5.5	5.5
	g	6	6	6	6	6
	g.1	2	2	2	2	2
	h	129	129	137	137	138
	i	50	50	55	55	55
Terminal for cond. cross section (mm ²) min.-max.		-2.5	-2.5	-6	-6	-6

2 MB 147

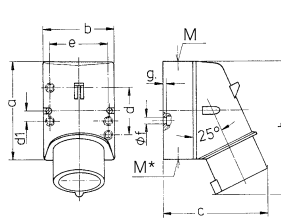

Drawing	Amp.	16		32	
2 MB 147	Poles	7		7	
Dim. in mm	a	100		128	
	b	75		84	
	c	110		135	
	d	—		—	
	d1	10.5		11	
	e	59		68	
	f	5		5.3	
	g	4		4	
	h	135		170	
	M	20		32	
	M*	20 (blind) to be cut out		2x25 (blind) to be cut out	
Max. cable diam. (mm)		15		18	
Terminal for cond. cross section (mm ²) min.-max.		-2.5		-4	

2 MB 155

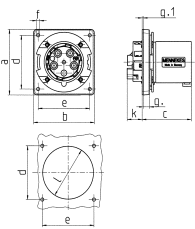

Drawing	Amp.	63		
2 MB 155	Poles	3	4	5
Dim. in mm	a	110	110	110
	b	106	106	106
	c	86	86	86
	d	90	90	90
	e	90	90	90
	f	5.5	5.5	5.5
	g	12	12	12
	g.1	2	2	2
	k	28	28	28
	l	88.5	88.5	88.5
Terminal for cond. cross section (mm ²) min.-max.		-16	-16	-16

2 MB 160

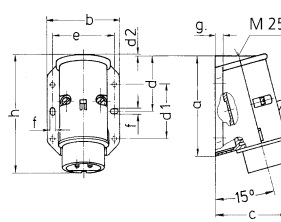

Drawing	Amp.	16		32	
2 MB 160	Poles	2	3	2	3
Dim. in mm	a	96	96	96	96
	b	73	73	73	73
	c	74	74	74	74
	d	53	53	53	53
	d1	52	52	52	52
	d2	2	2	2	2
	e	62	62	62	62
	f	5.3	5.3	5.3	5.3
	g	8	8	8	8
	h	116	116	116	116
Terminal for cond. cross section (mm ²) min.-max.		-10	-10	-10	-10

2 MB 166

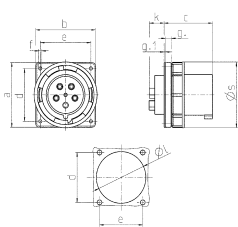

Drawing	Amp.	63			125		
2 MB 166	Poles	3	4	5	3	4	5
Dim. in mm	a	110	110	110	130	130	130
	b	106	106	106	130	130	130
	c	86	86	86	112	112	112
	d	90	90	90	104	104	104
	e	90	90	90	104	104	104
	f	5.5	5.5	5.5	6.5	6.5	6.5
	g	12	12	12	18	18	18
	g.1	2	2	2	2	2	2
	k	28	28	28	28	28	28
	l	88.5	88.5	88.5	98	98	98
	s	113	113	113	132	132	132
Terminal for cond. cross section (mm ²) min.-max.		-16	-16	-16	-70	-70	-70

2 MB 173/2

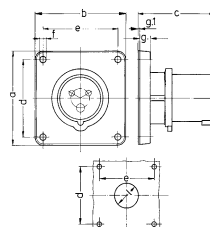

Drawing	Amp.	16			32		
2 MB 173/2	Poles	3	4	5	3	4	5
Dim. in mm	a	85.7	85.7	85.7	85.7	85.7	85.7
	b	85.7	85.7	85.7	85.7	85.7	85.7
	c	72	72	72	90	90	90
	d	69.5	69.5	69.5	69.5	69.5	69.5
	e	69.5	69.5	69.5	69.5	69.5	69.5
	f	5.5	5.5	5.5	5.5	5.5	5.5
	g	11	11	11	11	11	11
	g.1	2	2	2	2	2	2
	l	32	36	36	47	47	47
Terminal for cond. cross section (mm ²) min.-max.		1.5	1.5	1.5	2.5	2.5	2.5
		-4	-4	-4	-10	-10	-10

2 MB 187/2

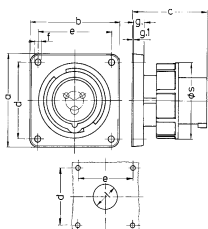

Drawing	Amp.	16			32		
2 MB 187/2	Poles	3	4	5	3	4	5
Dim. in mm	a	85.7	85.7	85.7	85.7	85.7	85.7
	b	85.7	85.7	85.7	85.7	85.7	85.7
	c	72	72	72	90	90	90
	d	69.5	69.5	69.5	69.5	69.5	69.5
	e	69.5	69.5	69.5	69.5	69.5	69.5
	f	5.5	5.5	5.5	5.5	5.5	5.5
	g	11	11	11	11	11	11
	g.1	2	2	2	2	2	2
	l	32	36	47	47	47	47
	s	71	79	89	94	94	102
Terminal for cond. cross section (mm ²) min.-max.		1.5	1.5	1.5	2.5	2.5	2.5
		-4	-4	-4	-10	-10	-10

2 MB 196

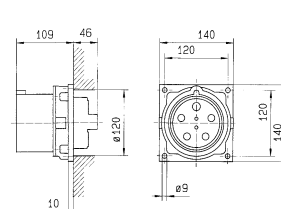

Drawing
2 MB 196
Dim. in mm

2 MB 197

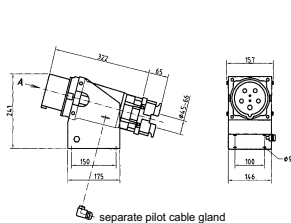

Drawing
2 MB 197
Dim. in mm

2 MB 199/1

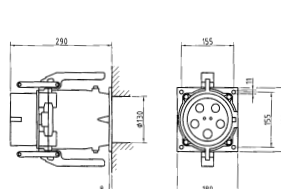

Drawing
2 MB 199/1
Dim. in mm

separate pilot cable gland

Service – Drawings and dimensions

The sizes for the entries on the drawings can be different to the real existing entry sizes. Subject to modification and amendments without prior notice. Errors and omissions excepted.

2 MB 200/1

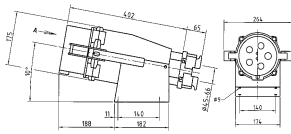

Drawing
2 MB 200/1
Dim. in mm

2 MB 203

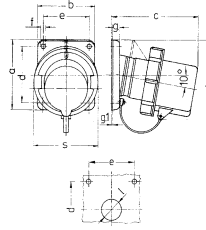

Drawing 2 MB 203 Dim. in mm	Amp. Poles	16		32	
		7		7	
a		85		85	
b		85		85	
c		132		137	
d		70		70	
e		70		70	
f		6.3		6.3	
g		11		11	
g.1		2		2	
h		107		111	
s		86		102	
l		30		30	
Terminal for cond. cross section (mm ²) min.-max.		1		2.5	
		-2.5		-6	

2 MB 206

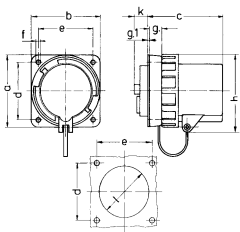

Drawing 2 MB 206 Dim. in mm	Amp. Poles	125	
		5	
a		130	
b		130	
c		120	
d		104	
e		104	
f		6.5	
g		18	
g.1		2	
h		131	
k		28	
l		98	
Terminal for cond. cross section (mm ²) min.-max.		25	
		-70	

2 MB 212

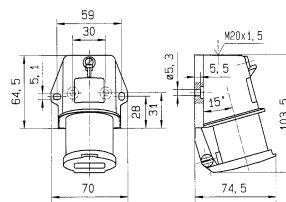

Drawing
2 MB 212
Dim. in mm

2 MB 213

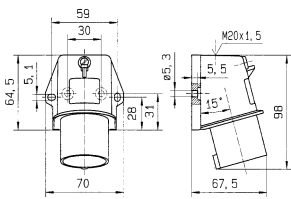

Drawing
2 MB 213
Dim. in mm

2 MB 221

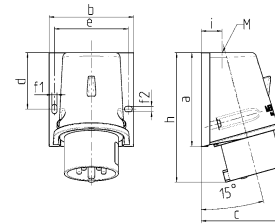

Drawing 2 MB 221 Dim. in mm	Amp. Poles	16		32		
		4	5	3	4	5
a		92.5	92.5	102	102	102
b		87	87	94	94	94
c		84.5	84.5	94	94	94
d		55.5	55.5	62	62	62
e		76	76	84	84	84
f1		5.3	5.3	5.3	5.3	5.3
f2		5.3	5.3	5.3	5.3	5.3
h		128	128	146	146	146
i		21.5	21.5	26	26	26
M		25x1.5	25x1.5	25x1.5	25x1.5	32x1.5

2 MB 247

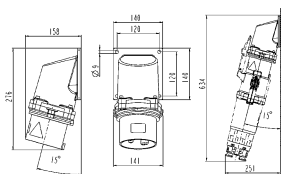

Drawing
2 MB 247
Dim. in mm

2 MB 248

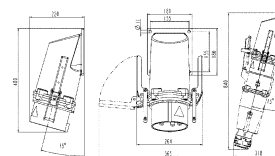

Drawing
2 MB 248
Dim. in mm

5 MB 57

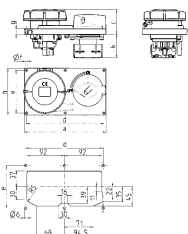

Drawing 5 MB 57 Dim. in mm	Amp. Poles	16			32		
		3	4	5	3	4	5
a		200	200	200	200	200	200
b		110	110	110	110	110	110
c		47	50	51	59	59	60
d		190	190	190	190	190	190
e		100	100	100	100	100	100
f		5	5	5	5	5	5
g		13	13	13	13	13	13
k max.		56	56	56	56	56	56

5 MB 59

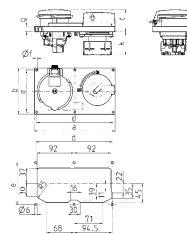

Drawing 5 MB 59 Dim. in mm	Amp. Poles	16			32		
		3	4	5	3	4	5
a		200	200	200	200	200	200
b		110	110	110	110	110	110
c		46	49	46	56	56	53
d		190	190	190	190	190	190
e		100	100	100	100	100	100
f		5	5	5	5	5	5
g		13	13	13	13	13	13
k max.		56	56	56	56	56	56

Service – Drawings and dimensions

The sizes for the entries on the drawings can be different to the real existing entry sizes. Subject to modification and amendments without prior notice. Errors and omissions excepted.

AMAXX®. Combination units.

Suspendable AMAXX®

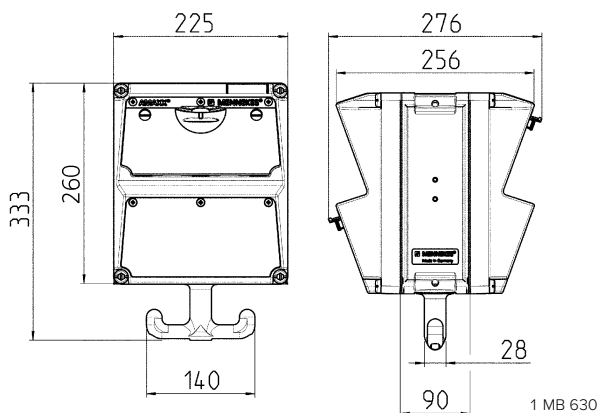

Depth dimensions for identical configuration on both sides.

Sockets	IP-degrees	Depth
SCHUKO® 16 A, 230 V	IP 44	282 mm
	IP 67	326 mm
CEE 16 A, 3 p, 230 V	IP 44	342 mm
	IP 67	350 mm
CEE 16 A, 5 p, 400 V	IP 44	354 mm
	IP 67	362 mm
CEE 32 A, 5 p, 400 V	IP 44	372 mm
	IP 67	382 mm

Cable entries: closed for cut out

1 x M 32 on top, 1 x M 25 on top and 1 x M 20 on top

AMAXX® with 1 segment

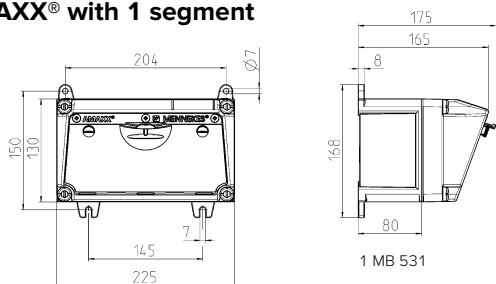

Depth dimensions of the AMAXX® enclosures with 1, 2, or 3 segments and various fittings.

Sockets	IP-degrees	Depth
SCHUKO® 16 A, 230 V	IP 44	175 mm
	IP 67	194 mm
CEE 16 A, 3 p, 230 V	IP 44	204 mm
	IP 67	205 mm
CEE 16 A, 5 p, 400 V	IP 44	209 mm
	IP 67	213 mm
CEE 32 A, 5 p, 400 V	IP 44	221 mm
	IP 67	227 mm
CEE 63 A, 5 p, 400 V	IP 44	248 mm
	IP 67	248 mm

AMAXX® with 2 segments

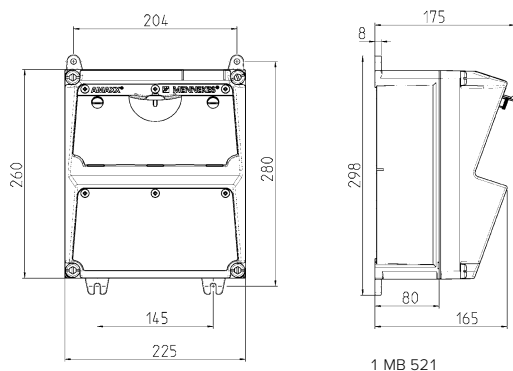

Cable entries: closed for cut out.

single enclosure 130 mm x 225 mm:
2 x M 25 on top and bottom

double enclosure 260 mm x 225 mm:
2 x M 32 on top and bottom

triple enclosure 390 mm x 225 mm:
2 x M 40 on top and bottom

For all enclosures: 2 x M 20 on top and bottom for cut out.

AMAXX® with 3 segments

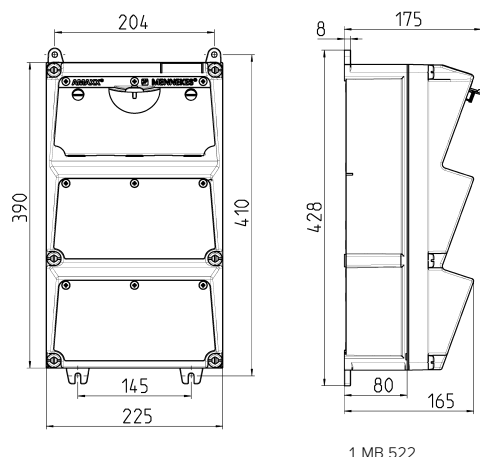

Service – Drawings and dimensions

The sizes for the entries on the drawings can be different to the real existing entry sizes. Subject to modification and amendments without prior notice. Errors and omissions excepted.

AMAXX®. Coffrets combinés.

AMAXX® with 4 segments

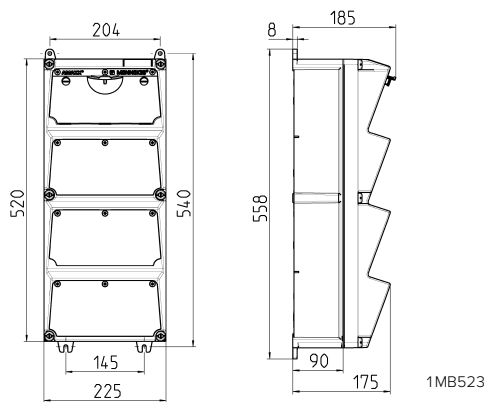

1MB523

Depth dimensions of the AMAXX® enclosures with 4 or 5 segments and various fittings.

Sockets	IP-degrees	Depth
SCHUKO® 16 A, 230 V	IP 44	186 mm
	IP 67	208 mm
CEE 16 A, 3 p, 230 V	IP 44	216 mm
	IP 67	220 mm
CEE 16 A, 5 p, 400 V	IP 44	222 mm
	IP 67	226 mm
CEE 32 A, 5 p, 400 V	IP 44	231 mm
	IP 67	236 mm
CEE 63 A, 5 p, 400 V	IP 44	260 mm
	IP 67	260 mm

AMAXX® with 5 segments

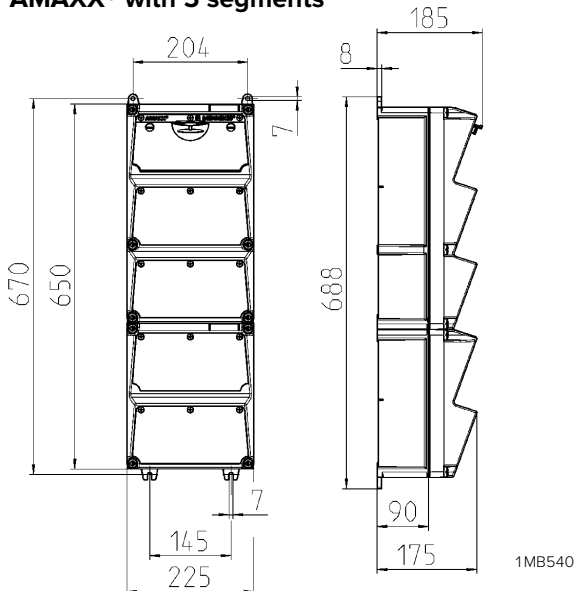

1MB540

Cable entries: closed for cut out.

quadruple enclosure 520 mm x 225 mm :
quintuple enclosure 650 mm x 225 mm :
 2 x M 40 on top and bottom

For both enclosures: 2 x M 20 on top and bottom for cut out.

AMAXX® s with 5 segments

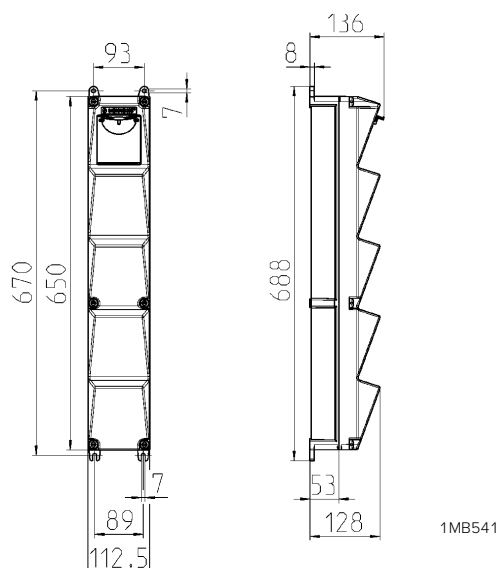

1MB541

Depth dimensions of the AMAXX® s enclosures with 5 segments and various fittings.

Sockets	IP-degrees	Depth
SCHUKO® 16 A, 230 V	IP 44	140 mm
	IP 67	157 mm
CEE 16 A, 3 p, 230 V	IP 44	170 mm
	IP 67	169 mm
CEE 16 A, 5 p, 400 V	IP 44	172 mm
	IP 67	174 mm
CEE 32 A, 5 p, 400 V	IP 44	182 mm
	IP 67	188 mm

Cable entries: closed for cut out.

AMAXX® s 650 mm x 112,5 mm:
 1 x M 25 each on top and bottom or
 1 x M 32 each on top and bottom

Additionally: 1 x M 20 each on top and bottom to cut out.

Service – Drawings and dimensions

The sizes for the entries on the drawings can be different to the real existing entry sizes. Subject to modification and amendments without prior notice. Errors and omissions excepted.

1 MB 441

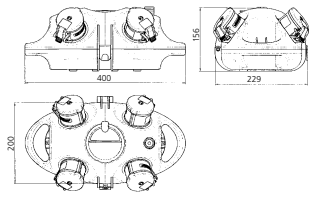

Drawing
1 MB 441
Dim. in mm

DIN rail / fusing for 4 modules beneath transparent operating lid.

Cable entry: at the top: 1 x M 32, 1 x M 25, 2 x M 20 (blind, to be cut out), 1 x cut out for quick pneumatic connection; from the side (for wall fixing or portable version): 1 x M 25 (blind, to be cut out).

1 MB 442

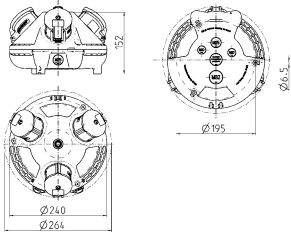

Drawing
1 MB 442
Dim. in mm

Cable entry: at the top: 1 x M 32, 1 x M 25, 2 x M 20 (blind, to be cut out), 1 x cut out for quick pneumatic connection; from the side (for wall fixing or portable version): 1 x M 25 (blind, to be cut out).

3 MB 44

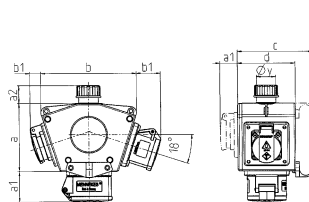

Pos.	Receptacles	IP-degrees	Dim.
a			114.0 mm
a1	SCHUKO* 16 A, 230 V	IP 44	max. 30.0 mm
a1	CEE 16 A, 3 p, 230 V	IP 44	52.7 mm
a1	CEE 16 A, 5 p, 400 V	IP 44	50.5 mm
a1	CEE 32 A, 5 p, 400 V	IP 44	64.0 mm
a2			30.0 mm
b			160.0 mm
b1	SCHUKO* 16 A, 230 V	IP 44	max. 18.0 mm
b1	CEE 16 A, 3 p, 230 V	IP 44	42.0 mm
b1	CEE 16 A, 5 p, 400 V	IP 44	40.0 mm
b1	CEE 32 A, 5 p, 400 V	IP 44	53.2 mm
c			133.0 mm
d			97.0 mm
y			17.0 mm

Cable entry: 1 x with gland diameter, Ø 17 mm or 27 mm

3 MB 45

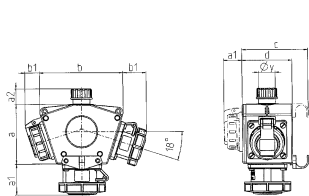

Pos.	Receptacles	IP-degrees	Dim.
a			114.0 mm
a1	SCHUKO* 16 A, 230 V	IP 68	35.0 mm
a1	CEE 16 A, 3 p, 230 V	IP 67	36.3 mm
a1	CEE 16 A, 5 p, 400 V	IP 67	59.0 mm
a2			30.0 mm
b			160.0 mm
b1	SCHUKO* 16 A, 230 V	IP 44	24.0 mm
b1	CEE 16 A, 3 p, 230 V	IP 44	44.3 mm
b1	CEE 16 A, 5 p, 400 V	IP 44	47.0 mm
c			133.0 mm
d			97.0 mm
y			17.0 mm

Cable entry: 1 x with gland diameter, Ø 17 mm or 27 mm

5 MB 35

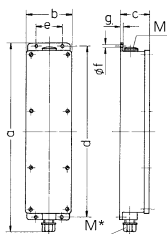

Dim. in mm	a	b	c	d	e	f	g.	M	M*
	401	97	63	364	56	5.5	4	25	25

Enclosure size: 401 x 97 mm
Cable entry: 1 x M 20 plugged at the top,
1 x M 20 with gland at the bottom

5 MB 41

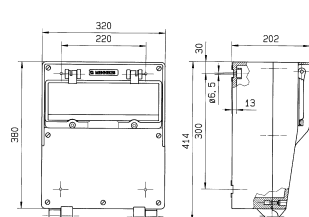

Drawing
5 MB 41
Dim. in mm

Enclosure size: 380 x 320 mm
Cable entry: 1 x M 40 at the top **with threaded cable gland** and 1 x M 40 plugged at the top
2 x M 40 plugged at the bottom Space for 16 modules

Service – Drawings and dimensions

The sizes for the entries on the drawings can be different to the real existing entry sizes. Subject to modification and amendments without prior notice. Errors and omissions excepted.

5 MB 42

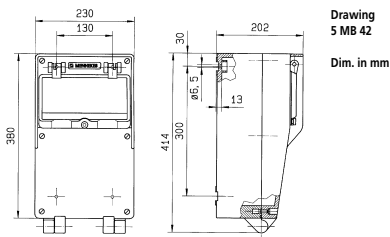

Drawing
5 MB 42

Dim. in mm

Dimensions: 380 x 230 mm

Cable entry: 1 x M 40 at the top **with threaded cable gland** and 1 x M 40 plugged at the top
2 x M 40 plugged at the bottom Space for 12 modules.

5 MB 43

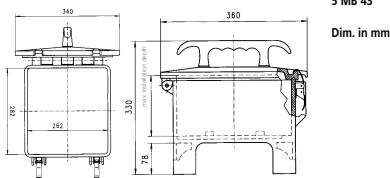

Drawing
5 MB 43

Dim. in mm

Enclosure size: 360 x 340 x 330 mm

5 MB 44

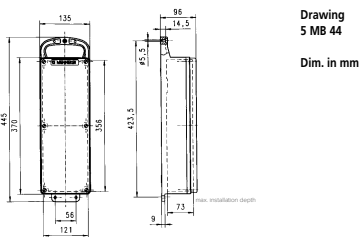

Drawing
5 MB 44

Dim. in mm

Enclosure size: 445 x 135 mm

5 MB 48a

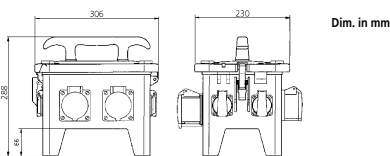

Drawing
5 MB 48a

Dim. in mm

Enclosure size: 300 x 230 x 287.5 mm

1 MB 430

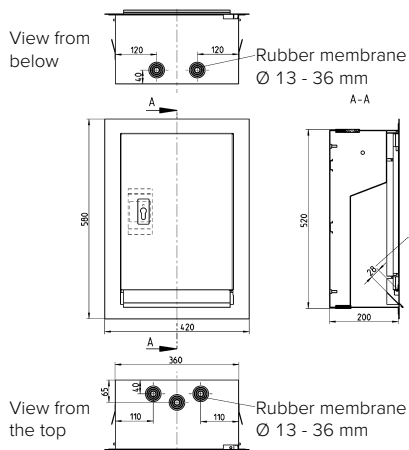

View from
below

Rubber membrane
Ø 13 - 36 mm

A-A

max.
cable
diameter

with lid
drawing
15644

View from
the top

Rubber membrane
Ø 13 - 36 mm

1 MB 437

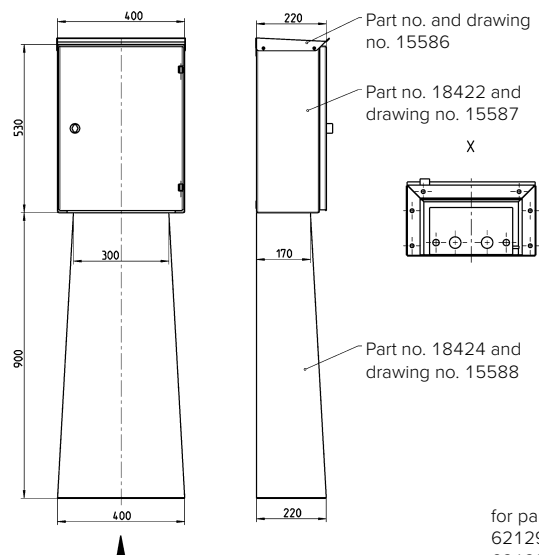

Part no. and drawing
no. 15586

Part no. 18422 and
drawing no. 15587

X

Part no. 18424 and
drawing no. 15588

for part no.
6103180 and
6103196

for part no.
6212980 and
6212993

Service – Drawings and dimensions

The sizes for the entries on the drawings can be different to the real existing entry sizes. Subject to modification and amendments without prior notice. Errors and omissions excepted.

1 MB 443

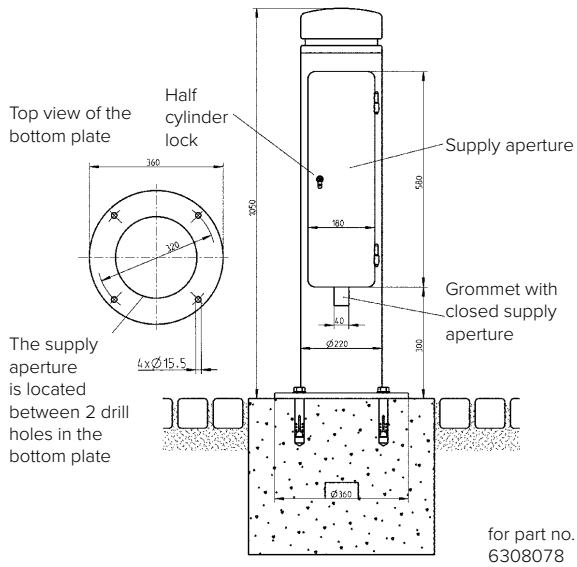

1 MB 473

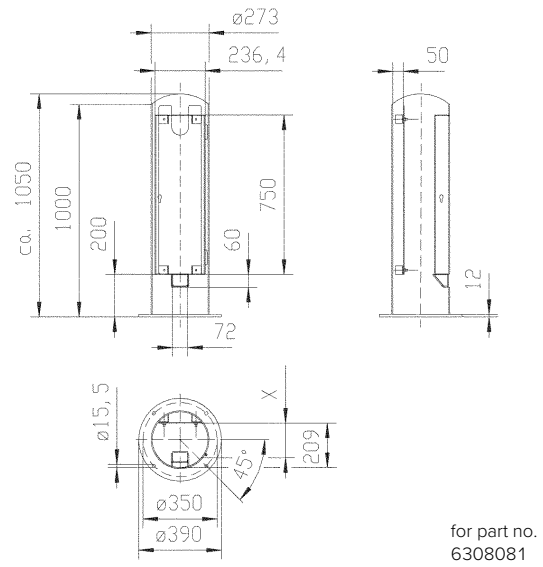

1 MB 517

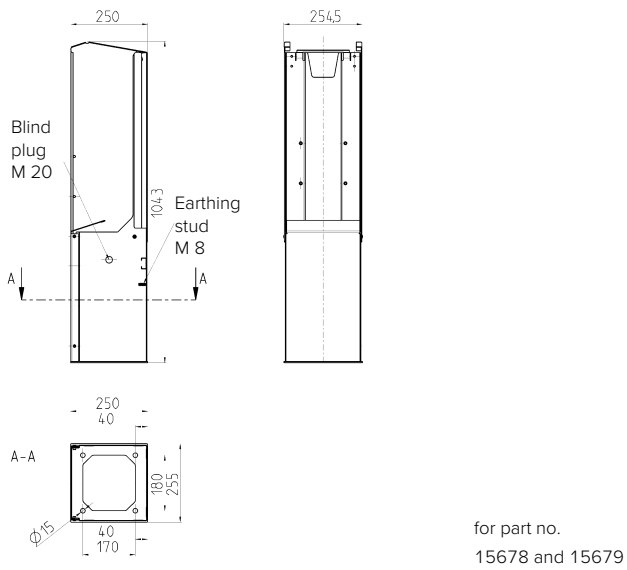

1 MB 518

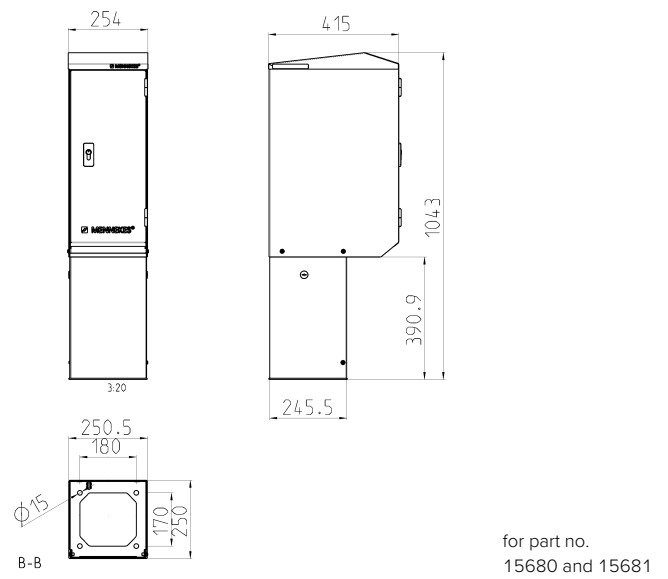

Service – Index of part numbers

Part no.	Page	Part no.	Page	Part no.	Page	Part no.	Page	Part no.	Page	Part no.	Page	Part no.	Page
3	31	194A	38	277	32	361	33	523	38	664A	75	824	34
4	31	195A	38	278	32	362	33	524	38	668A	75	825	34
5	38	203A	24	279	32	363	33	525	38	669A	75	826	34
6	38	204A	24	280	32	364	33	526	38	674A	75	827	34
13A	31	205A	24	281	32	365	33	527	38	675A	75	828	34
14A	31	206A	24	282	32	366	33	528	38	676A	75	829	34
15A	38	207A	24	283	32	367	33	529	38	677A	75	830	34
16A	38	208A	24	284	32	368	33	530	38	707A	75	831	34
31	15	209A	24	285	32	371	35	531	38	708A	75	832	34
32	15	210A	24	286	32	372	35	539	39	711	31	833	34
33	31	211A	24	287	32	373	35	540	39	712	31	834	34
34	31	212A	24	288	32	374	35	541	39	713A	75	835	34
35	38	213A	24	289	32	377	35	542	39	714A	75	836	34
36	38	214A	24	290	32	378	35	543	39	715A	75	837	34
100	13	215A	24	291	32	379	35	544	39	716A	75	838	34
101	13	216A	24	292	32	380	35	545	39	717	31	839	34
102	13	217A	24	293	32	381	35	546	39	719	31	840	34
103	13	218A	24	294	32	382	35	547	39	720A	75	843	33
104	13	219A	24	295	32	383	35	548	39	721A	75	844	33
105	13	220A	24	296	32	384	35	549	39	723	31	846	33
106	13	221A	24	297	32	385	35	550	39	725	38	847	33
107	13	222A	24	298	32	386	35	551	39	726A	75	851	90
108	13	223A	24	299	32	389	35	552	39	727A	75	852	90
109	13	224A	24	300	32	390	35	553	39	728A	75	853	34
110	13	225A	24	315	31	391	35	554	39	729A	75	854	37
111	13	226A	24	318	36	392	35	555	39	731	38	855	37
121	38	227A	24	319	36	393	35	556	39	733	71	856	13
122	38	228A	24	321	36	394	35	557	39	734	71	857	23
125	38	229A	24	322	36	395	35	558	39	735	71	858	23
126	38	230A	24	325	36	396	36	559	39	736	71	859	36
127	38	231A	24	327	36	397	36	560	39	737	71	890	31
128A	13	232A	24	328	36	398	35	561	39	738	71	891	31
129A	13	233A	24	329	37	399	35	562	39	739	71	903	24
130A	13	234A	24	330	37	400	35	577	73	740	71	905	24
131A	13	235A	24	331	33	401	35	578	73	741	71	907	25
132A	13	236A	24	332	33	402	35	583	73	742	71	913	37
133A	13	237A	24	333	33	403	35	584	73	743	71	921	33
134A	13	238A	24	334	33	404	35	585	73	744	71	922	33
135A	13	239A	24	335	33	405	35	586	73	745	72	947	31
136A	13	240A	24	336	33	406	35	590	73	746	72	948	31
137	14	247	31	337	33	407	35	591	73	747	72	951	31
138	14	248	31	338	36	410	35	596	73	748	72	952	31
139	14	249	31	339	36	411	35	597	73	749	72	953	31
140	14	250	31	340	33	412	35	598	73	750	72	954	31
141	14	251	31	341	33	418	15	599	73	751	72	965	38
142	14	252	31	342	33	419	15	603	74	752	72	979	38
143	14	253	31	343	33	420	15	604	74	761	38	980	38
147A	31	254	31	344	33	421	15	609	74	763	38	987	25
148A	31,90	255	31	345	33	422	15	610	74	765	38	988	25
151A	31	256	31	346	33	509	38	611	74	800	33	989	25
152A	31	257	31	347	33	510	38	612	74	801	33	993	38
153A	31	259	31	348	33	511	38	616	74	802	33	994	38
159	31	260	31	349	33	512	38	617	74	803	33	996	38
160	31	261	31	352	33	513	38	622	74	804	33	997	25
163	31	262	31	353	33	514	38	623	74	812	34	998	25
164	31	263	31	354	33	515	38	624	74	813	34	1035	71
165	31	264	31	355	33	516	38	625	74	814	34	1040	71
179A	38	265	31	356	33	517	38	655A	75	815	34	1045	71
180A	38	266	31	357	33	518	38	656A	75	817	34	1050	71
180AC	90	267	31	358	33	519	38	661A	75	819	34	1055	71
181A	38	268	31	359	33	521	38	662A	75	820	34	1060	71
193A	38	269	31	360	33	522	38	663A	75	821	34	1065	72

Service – Index of part numbers

Part no.	Page	Part no.	Page	Part no.	Page	Part no.	Page	Part no.	Page	Part no.	Page	Part no.	Page
1070	72	1345	15	1470	23	1644	25	1744	25	1855	15	2400	33
1075	72	1346	15	1471	23	1646	25	1745	25	1856	15	2405	72
1080	72	1347	15	1472	23	1647	15	1746	25	1857	15	2406	72
1081	24	1348	15	1473	23	1648	15	1747	25	1858	15	2441	38
1082	24	1349	15	1474	24	1649	15	1749	25	1859	15	2459	71
1103	24	1365	23	1475	24	1650	15	1750	15	1860	15	2460	72
1107	33	1366	23	1476	24	1651	15	1751	15	1861	15	2478	37
1122A	24	1367	23	1477	24	1657	74	1752	15	1862	15	2488A	74
1123A	24	1384	23	1478	24	1661	74	1753	15	1864	15	2493	38
1124A	24	1385	23	1479	24	1667	25	1754	15	1955	75	2495	38
1125A	24	1386	23	1480	24	1668	25	1755	15	1959	75	2511	37
1126A	24	1388	23	1481	24	1669	25	1756	15	1961	75	2517	38
1127A	24	1389	23	1482	24	1671	25	1757	15	1962	75	2617A	74
1128A	24	1390	23	1483	24	1672	25	1786	25	1965	75	2668	33
1131	26	1391	23	1484	24	1673	25	1787	25	1967	75	2674	38
1132	25	1392	23	1485	24	1674	25	1788	25	1968	75	2692	86
1133	25	1393	23	1486	23	1675	25	1789	25	1972	75	2837	74
1134	25	1394	23	1487	23	1676	25	1790	25	1974	75	2841	74
1135	25	1395	23	1489	24	1677	25	1791	25	1975	75	2845	74
1136A	13	1396	23	1490	24	1678	25	1792	25	1978	75	2852	74
1137A	13	1397	23	1491	23	1679	25	1793	25	1980	75	2855	74
1140A	13	1398	23	1492	23	1680	25	1794	25	1981	34	2860	74
1141A	13	1399	23	1493	23	1682	25	1795	25	1982	34	2864	74
1142A	13	1400	23	1494	23	1688	34	1796	25	1983	34	2869	74
1144A	13	1401	23	1495	23	1693	74	1797	25	1984	34	2870	74
1145A	13	1402	23	1496	23	1700	26	1798	25	2000	13	2883	71
1146A	23	1408	34	1497	23	1701	26	1800	25	2007A	13	3004	25
1147A	23	1409	34	1498	23	1702	26	1801	26	2014	31	3008	25
1148A	23	1410	31	1499	23	1703	26	1802	26	2015	31	3028	13
1149A	23	1411	31	1500	23	1704	26	1803	26	2026	38	3030	13
1150A	23	1412	31	1501	24	1705	26	1804	26	2027	38	3031	23
1151A	23	1414	35	1502	24	1706	26	1805	26	2123A	85	3032	13
1152A	23	1415	35	1503	24	1707	26	1806	26	2139	14	3034	13
1153A	23	1418	13	1504	24	1708	26	1807	26	2166	72	3035	13
1154A	23	1419	13	1505	24	1709	26	1808	26	2167	72	3036	23
1155A	23	1420	13	1506	24	1710	26	1809	26	2168	31	3039	13
1166	25	1421	13	1507	24	1711	26	1810	26	2169	31	3043	13
1167	25	1422	13	1551	24	1712	26	1811	26	2175B	85	3045	13
1168	26	1423	13	1555	13	1713	26	1812	26	2177A	86	3046	13
1169	26	1424	13	1556	13	1714	26	1813	26	2178	31	3048	25
1171	26	1425	13	1557	13	1715	26	1814	26	2179A	24	3049	25
1173	26	1426	13	1567	24	1716	26	1815	26	2180A	24	3054	23
1216	33	1427	13	1568	24	1717	26	1816	26	2181A	24	3055	23
1217	33	1428	13	1579	74	1719	15	1817	26	2199	13	3057	23
1247A	23	1436	35	1594	74	1720	15	1818	26	2189	31	3059	23
1248A	23	1437	35	1595	74	1721	15	1819	26	2193	38	3060	23
1249A	23	1438	38,90	1602	74	1723	15	1820	26	2195	31	3070	25
1252A	23	1455	24	1603	74	1724	15	1823	74	2196	38	3072	23
1260A	23	1456	24	1618	25	1725	15	1825	73	2212	71	3074	23
1261A	23	1457	24	1619	25	1726	15	1829	73	2213	72	3093	23
1263A	24	1458	24	1631	25	1727	15	1831	73	2241	13	3110	23
1264A	24	1459	24	1632	25	1730	15	1832	73	2243	31	3112	23
1265A	24	1460	24	1633	25	1733	25	1835	73	2244	31	3114	23
1270	74	1461	24	1635	25	1734	25	1837	73	2245	38	3124	25
1271	74	1462	23	1636	25	1735	25	1838	73	2255	72	3126	25
1272	74	1463	23	1637	25	1737	25	1842	73	2271	31	3134	13
1273	74	1464	23	1638	25	1738	25	1844	73	2296	71	3136	23
1340	15	1465	23	1639	25	1739	25	1845	73	2317	71	3137	23
1341	15,90	1466	23	1640	25	1740	25	1848	73	2324	72	3139	13
1342	15	1467	23	1641	25	1741	25	1850	73	2341	31	3140	23
1343	15	1468	23	1642	25	1742	25	1851	15	2359	33	3141	13
1344	15	1469	23	1643	25	1743	25	1852	15	2386	33	3149	13

Service – Index of part numbers

Part no.	Page	Part no.	Page	Part no.	Page	Part no.	Page	Part no.	Page	Part no.	Page	Part no.	Page
3152	13	3485	26	3879	39	4220	22	5608A	16	7290	17	7628	17
3153	23	3507	24	3881	39	4224	22	5690A	17	7291ZA	18	7629	17
3154	13	3517	37	3883	39	4226	22	5691A	17	7292	18	7633	17
3155	25	3523	37	3887	39	4233	22	5691AM	21	7293ZA	18	7634	17
3157	25	3524	24	3888	39	4254	22	5692A	17	7294	18	7635	17
3171	25	3527	35	3891	39	4258	22	5692AM	21	7295	18	7636	17
3186	23	3528	35	3896	39	4259	22	5696A	16	7296	18	8001	90
3187	23	3566	26	3897	39	4300	80	5743A	16	7306	71	8008	90
3188	23	3573	26	3898	39	4302	80	5759A	16	7307	71	9104	15
3189	23	3575	24	3899	39	4304	80	5792A	85	7312	18	9105	15
3190	23	3581	26	3905	39	4320	80	5793A	16	7313	18	9106	15
3191	23	3583	34	3907	39	4322	80	5887A	17	7356	18	9120	15
3192	23	3587	26	3909	39	4324	80	5888A	17	7386	20	9121	15
3193	23	3590	26	3913	72	4326	80	5911A	16	7388	16	9122	15
3197	24	3600	34	3914	72	4340	80	5924A	16	7392	20	9123	15
3200	24	3646	31	3915	72	4342	80	5925A	16	7393UK	20	9124	15
3201	23	3656	34	3916	72	4344	80	5946A	85	7394	18	9125	15
3202	23	3657	34	3917	35	4345	80	5955A	16	7434	20	9140	15
3231	35	3658	34	3980	31	4350	80	5956A	16	7469	18	9141	15
3232	35	3665	34	3981	31	4352	80	5957A	16	7470UK	20	9142	15
3254	24	3704	34	3982	31	4354	80	5959A	16	7502	27	9150	15
3256	24	3717	37	3983	31	4360	80	6571	16	7503	27	9151	15
3266	31	3718	85	3987	31	4362	80	7000	17	7504	27	9152	15
3283	24	3773	14	3999	39	4364	80	7000AM	21	7505	27	9170	15
3290	74	3774	14	4101	22	4365	80	7002A	16	7506	27	9171	15
3306	31	3775	71	4102	22	4366	80	7010A	16	7507	27	9172	15
3312	31	3776	72	4103	22	4367	80	7011A	16	7511	27	9173	15
3319A	36	3777	72	4104	22	4370	80	7012A	16	7512	27	9174	15
3322	36	3778	39	4105	22	4372	80	7051ZC	18	7513	27	9175	15
3331	15	3779	72	4106	22	4374	80	7060	17	7514	27	9180	15
3338	36	3780	72	4107	22	4375	80	7123	18	7515	27	9181	15
3339	36	3781	72	4108	22	4377	80	7124	18	7516	27	9182	15
3340	36	3782	72	4110	22	4378	80	7125	18	7520	27	9300	13
3341	36	3783	72	4111	22	4379	80	7126	18	7521	27	9301	13
3342	37	3784	72	4112	22	5099A	16	7127	18	7523	27	9302	13
3343	37	3794	32	4113	22	5100A	16	7148	18	7524	27	9320	13
3345	37	3796	32	4114	22	5101A	16	7149	18	7525	27	9321	13
3346	37	3799	32	4115	22	5102A	16	7150	18	7526	27	9322	13
3347	37	3807	32	4116	22	5103A	16	7151	18	7530	27	9323	13
3348	37	3809	32	4117	22	5104A	16	7152	18	7531	27	9325	13
3350	37	3810	32	4118	22	5105A	16	7245UK	20	7533	27	9340	13
3355	37	3811	32	4119	22	5106A	16	7246UK	20	7534	27	9341	13
3356	37	3819	32	4120	22	5107A	16	7247UK	20	7535	27	9342	13
3357	37	3821	32	4121	22	5108A	16	7248UK	20	7536	27	9350	13
3367	37	3823	32	4122	22	5109A	16	7249UK	20	7602	16	9351	13
3368	37	3829	32	4123	22	5110A	16	7250	20	7603	16	9352	13
3380	24	3830	32	4124	22	5111A	16	7251	20	7604	16	9370	13
3385	25	3832	32	4125	22	5112A	16	7252	20	7605	16	9371	13
3413	34	3839	32	4126	22	5113A	16	7253	20	7606	16	9372	13
3420	35	3841	32	4127	22	5457A	16	7254UK	20	7607	16	9373	13
3424	31	3842	32	4128	22	5459A	16	7255	20	7611	16	9374	13
3447	23	3844	32	4130	22	5460A	16	7256UK	20	7612	16	9380	13
3449	23	3851	32	4132	22	5462A	16	7257	20	7613	16	9381	13
3451	23	3853	32	4133	22	5599A	16	7258	20	7614	16	9382	13
3452	23	3855	32	4135	22	5600A	16	7260	20	7615	16	9530	71
3454	23	3859	39	4137	22	5601A	16	7283	16	7616	16	9531	71
3455	23	3860	39	4138	22	5602A	16	7284	16	7620	17	9532	71
3458	35	3862	39	4140	22	5603A	16	7285	16	7621	17	9562	85
3459	35	3869	39	4204	22	5604A	16	7286	16	7623	17	9590	71
3460	35	3871	39	4205	22	5605A	16	7287	16	7624	17	9591	71
3461	35	3872	39	4218	22	5606A	16	7288	16	7625	17	9592	71
3473	25	3873	39	4219	22	5607A	16	7289	17	7626	17	10081	67

Service – Index of part numbers

Part no.	Page	Part no.	Page	Part no.	Page	Part no.	Page	Part no.	Page	Part no.	Page	Part no.	Page
10082	67	13105	31	15678	65	24785	89	70049	59	75441	77	922218	19
10083	67	13106	31	15679	65	24786	89	70350	59	75448	77	922452	19
10087	68	13107	31	15680	65	24787	89	70351	59	90839	56	922453	19
10092	67	13111	31	15681	65	24788	89	71062	59	92658	56	922517	19
10713	68	13112	31	15696	50	24840	88	75001	77	92893	56	922518	19
10718	68	13201	32	15738	65	24841	88	75006	77	92917	56	922519	19
10749	68	13202	32	15739	65	24842	88	75011	78	94351	55	922520	20
10751	68	13203	32	15740	65	24843	88	75016	78	94354	55	922521	20
10754	68	13204	32	15741	65	24870	89	75021	77	94355	55	922522	20
10755	68	13205	32	17002	69	24873	89	75026	77	94357	55	923274	19
10828	69	13206	32	17006	69	24885	89	75031	77	94550	55	923275	19
10833	69	13207	32	17014	69	24888	89	75036	77	94552	55	923276	19
10837	68	13208	32	20458	88	24970	89	75041	77	94553	55	923277	19
10838	68	13209	32	20459	88	24973	89	75046	77	94559	55	923296	19
10839	68	13210	32	20460	88	24985	89	75053	77	95472	57	923297	19
10840	68	13211	32	20461	89	24988	89	75058	77	96227	57	931227	46
10841	68	13212	32	20462	89	25042	82	75063	77	96489	57	931234	47
10842	68	13213	32	20463	89	25056	82	75068	77	96703	57	931539	19
10843	68	13214	32	20970	37	25102	79	75073	77	96705	57	931975	19
10844	68	13215	32	21241	37	25102GE	79	75078	77	900946	49	932285	19
10845	68	13216	32	22189A	88	25405	83	75091	77	910214	45	932459	19
10846	68	13217	32	22928	88	27001	13	75096	77	910244	19	933273	19
10863	69	13218	32	23151	88	27002	13	75101	78	910245	19	934285	19
11010	67	13219	32	23152	88	27003	13	75106	78	910246	19	940027	87
11011	67	13220	32	23153	88	27004	13	75111	77	910253	18	941137	47
11012	67	13223	32	23163	88	27005	13	75116	77	910355	48	941142	51
11013	67	13224	32	23164	88	27006	13	75121	77	910393	48	960043	46
11030	67	13225	32	23165	88	27007	13	75126	77	910394	45	970001	53
11031	67	13226	32	23175	88	27008	13	75131	77	920278	19	970002	52
11032	67	13227	32	23176	88	40744	90	75136	77	920286	45	970003	53
11033	67	14101	38	23177	88	40778	32	75172	78	920464	46	970004	52
11060	67	14102	38	23249	89	40784	32	75173	78	920649	19,49	970005	53
11061	67	14105	38	23293A	88	40785	32	75174	77	920666	20	990606	50
11081	67	14106	38	23432	88	40786	32	75201	77	920668	20	990607	50
11110	67	14107	38	23433	89	40787	32	75206	77	920670	20	990608	50
11111	67	14111	38	24210	89	40788	32	75211	78	920700	19,48	990609	50
11131	67	14112	38	24630	88	40841	32,86	75216	78	920714	48	990610	50
11160	67	14201	39	24640	88	41000	24,26	75221	77	920791	19	990611	50
11161	67	14202	39	24641	88	41342	86	75226	77	920821	19,51	990612	50
11162	67	14203	39	24642	88	41452	82	75231	77	920836	19	990620	50
11180	67	14204	39	24643	88	41455	82	75236	77	920838	19	990623	50
11181	67	14205	39	24660	89	41457	82	75241	77	920839	19	990625	50
11182	67	14206	39	24670	89	41482	33	75246	77	920840	19	990627	50
11310	67	14207	39	24671	89	41489	33	75251	78	920841	19	997000	53
11311	67	14208	39	24672	89	41492	82	75256	78	920845	19	997001	53
11312	67	14209	39	24673	89	52001	57	75261	78	920851	47	6103180	63
11313	67	14210	39	24675	89	52003	57	75266	78	920859	19	6103196	63
11330	67	14211	39	24685	89	52005	57	75271	77	920860	19,46	6212980	63
11331	67	14212	39	24686	89	52033	21	75276	77	920861	19	6212993	63
11332	67	14213	39	24687	89	52034	21	75284	78	920862	19	6308078	64
11333	67	14214	39	24688	89	52035	21	75287	78	920863	19	6308081	64
11511	67	14215	39	24730	88	52241MEG	91	75291	78	920864	19	8107705	79
11512	67	14216	39	24740	88	52242MEG	91	75295	78	920958	18	9500417	61
11531	67	14217	39	24741	88	52243MEG	91	75311	78	920961	18	9500706	61
11532	67	14218	39	24742	88	52244MEG	91	75316	78	920962	18	9500719	60
11561	67	14219	39	24743	88	52245MEG	91	75321	78	921015	45	9500722	61
11581	67	14220	39	24760	89	52246MEG	91	75326	78	921022	51	9500748	61
11611	68	14223	39	24770	89	60757MEG	32	75331	78	921024	51	15452000	38
11661	68	14224	39	24771	89	70007	59	75336	78	921160	19	15453000	38
11681	68	14225	39	24772	89	70025	59	75389	78	921380	19		
13101	31	14226	39	24773	89	70029	59	75398	78	921442	19		
13102	31	14227	39	24775	89	70033	59	75437	77	921953	19		

MENNEKES

Electric Ltd.

Unit 4, Crayfields Industrial Park
Main Road, St. Pauls Cray
Orpington, KENT
BR5 3HP, UK

Phone +44 1689 833522
Fax +44 1689 833378
sales@MENNEKES.co.uk

www.MENNEKES.co.uk

Headquarters:

MENNEKES

Elektrotechnik GmbH & Co. KG

Aloys-Mennekes-Straße 1
57399 KIRCHHUNDEM
GERMANY

Phone +49 2723 41-1
Fax +49 2723 41-214
info@MENNEKES.de

www.MENNEKES.com



1033800DS2T0220.V

Subject to change without notice.
No liability accepted for printing
errors.

Platzhalter FSC-
Logo